

# XST-3535-UV

## Surface Mount

### UVC LED

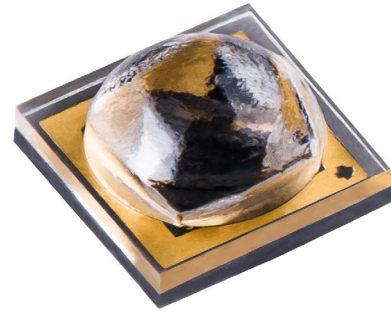

#### Table of Contents

Binning and Ordering .....	
Information.....	2
Optical and Electrical	
Characteristics .....	4
Mechanical Dimensions ....	7
Soldering Profile .....	8
Product Shipping & Labeling	
Information.....	9
Precautions for Use.....	10
History of Changes .....	11

#### Features:

---

- UVC LED with emission wavelength between 270 nm and 285 nm
- High Optical Power: 100 mW+ of UVC power at maximum rated current
- Compact form factor: 3.5 mm x 3.5 mm package
- Narrow viewing angle of 60 degrees
- Standard SMT Process
- RoHS and REACH compliant

#### Applications

---

- Air Purification
- Water Purification
- Surface Disinfection
- Medical Device Sterilization
- Appliance Sterilization
- Food & Beverage Preparation

## XST-3535-UV Binning Structure

XST-3535-UV LEDs are tested at a drive current of 350 mA, 20 ms single pulse at 25° C and placed into one of the following radiometric flux (FF), wavelength (WWW) and forward voltage bins bins.

### Radiometric Flux Bins

The LEDs can also be driven at higher drive currents, to achieve the correlated flux values listed in the table.

Flux Bin (FF)	Minimum Flux (mW) 350 mA, 25° C	Maximum Flux (mW) 350 mA, 25° C	Correlated Minimum Flux (mW) at 25° C		
			500 mA	650 mA	800 mA
CD	35	40	49	64	79
CE	40	45	56	74	90
CF	45	50	63	83	101
CG	50	55	70	92	113
CH	55	60	77	101	124

*Note 1: Product lifetime is a function of drive current. Sustained operation at absolute maximum current of 800 mA will result in a reduction of device lifetime compared to typical forward drive currents (350 mA-500 mA). Actual device lifetimes will also depend on junction temperature. Contact Luminus for information on product lifetime.*

### Wavelength Bins

Wavelength Bin (WWW)	Minimum Wavelength (nm)	Maximum Wavelength (nm)
270	270	275
275	275	280
280	280	285

*Note 2: Luminus maintains a +/- 6% tolerance on flux measurements and +/- 1 nm on wavelength measurements.*

*Note 3: Individual flux bins are not orderable. Please refer to product ordering information on page 3 for a list of ordering part numbers.*

### Forward Voltage Bins

Voltage Bin	Minimum Forward Voltage (V)	Maximum Forward Voltage (V)
V3	5.0	5.5
V4	5.5	6.0
V5	6.0	6.5
V6	6.5	7.0
V7	7.0	7.5

### Part Number Nomenclature

XST — 3535 — <UV> — <A##> — <FF###>

Product Family	Package Type	Color	Package Configuration	Bin kit
XST: UVC Surface Mount Package	3535: 3.5 mm x 3.5 mm	Ultraviolet	A60: 60 degree lens	Flux and Wavelength bin kit code - See ordering informaton

### Ordering Part Numbers

The table below lists ordering part numbers available for XST-3535-UV LEDs. The part number includes a bin kit, a group of flux and wavelength bins described in page 2, that are shippable for a given ordering part number. Individual flux bins are not orderable. Flux bin listed is minimum bin shipped - higher bins may be included at Luminus' discretion.

Wavelength Range	Wavelength Bins	Radiometric Flux		Ordering Part Number
		Bin Kit Flux Code	Min. Flux (mW)	
270-280	270, 275	CD	35	XST-3535-UV-A60-CD270-00
275-280	275	CD	35	XST-3535-UV-A60-CD275-01
280-285	280	CD	35	XST-3535-UV-A60-CD280-01
275-285	275, 280	CD	35	XST-3535-UV-A60-CD275-00
270-280	270, 275	CE	40	XST-3535-UV-A60-CE270-00
275-280	275	CE	40	XST-3535-UV-A60-CE275-01
280-285	280	CE	40	XST-3535-UV-A60-CE280-01
275-285	275, 280	CE	40	XST-3535-UV-A60-CE275-00

### Optical and Electrical Characteristics<sup>1,3</sup>

Parameter	Symbol	Value	Unit
Minimum Forward Voltage	$V_{f-min}$	5.0	V
Typical Forward Voltage	$V_{f-typ}$	6.45	V
Maximum Forward Voltage	$V_{f-max}$	7.5	V
FWHM	$\Delta\lambda$	10	nm
Viewing Angle	$2\theta_{1/2}$	60	°
Thermal Resistance (junction-solder point)	$R_{th}$	5.0	°C/W

### Absolute Maximum Ratings<sup>2,3</sup>

Parameter	Symbol	Value	Unit
Forward Current	$I_{f-max}$	800	mA
Junction Temperature	$T_j$	100	°C

Note 1: Ratings are based on operation at a constant junction temperature of  $T_j = 25^\circ\text{C}$ . Test conditions: 350 mA, 20 ms pulse at  $25^\circ\text{C}$ .

Note 2: Product lifetime is a function of drive current. Sustained operation at absolute maximum current of 800 mA will result in a reduction of device lifetime compared to typical forward drive currents (350-500 mA). Actual device lifetimes will also depend on junction temperature. Contact Luminus for details.

Note 3: XST-3535-UV LEDs are short wavelength, deep UV LEDs. During operation, the LED emits high intensity UVC radiation, which is harmful to skin and eyes. UV light is also hazardous to skin and may cause cancer. Avoid exposure to deep UV light when LED is operational.

## Optical & Electrical Characteristics

### Relative Power vs. Forward Current

$\phi/\phi_{(350\text{ mA})}$ , 20 ms pulse,  $T_j = 25^\circ\text{C}$

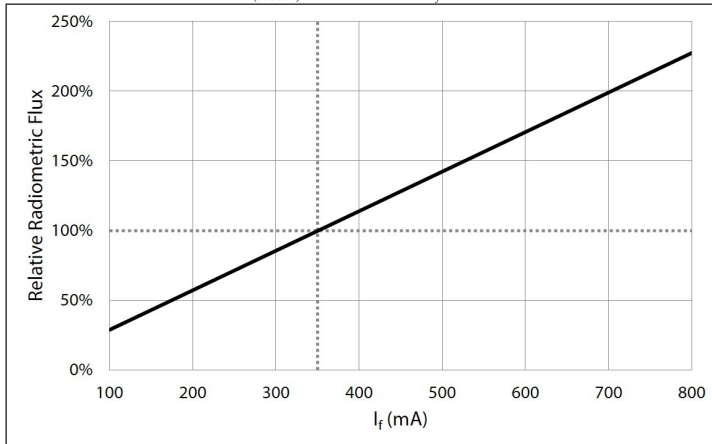

### Relative Power vs. Junction Temperature

$\phi/\phi_{(25^\circ\text{C})}$ , 20 ms pulse, 350 mA

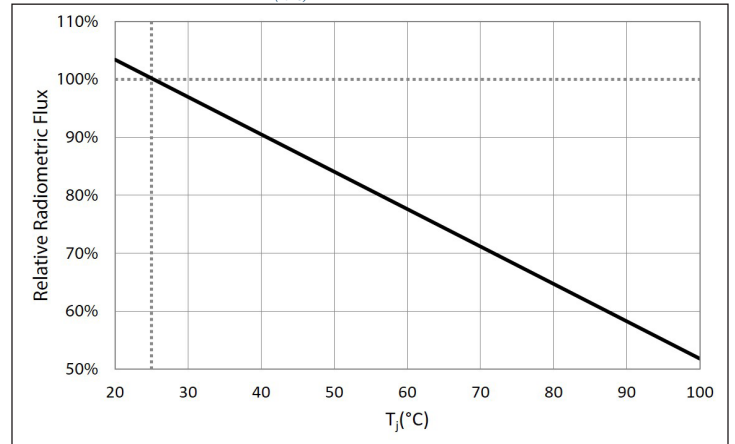

### Peak Wavelength Shift vs. Forward Current

$\lambda_p = \lambda_p(I_f) - \lambda_p(350\text{ mA})$ , 20 ms pulse,  $T_j = 25^\circ\text{C}$

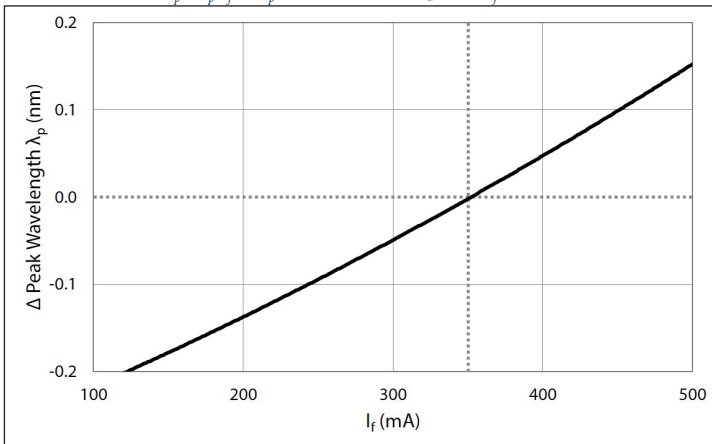

### Peak Wavelength Shift vs. Junction Temperature

$\lambda_p = \lambda_p(T_j) - \lambda_p(25^\circ\text{C})$ , 20 ms pulse,  $I_f = 350\text{ mA}$

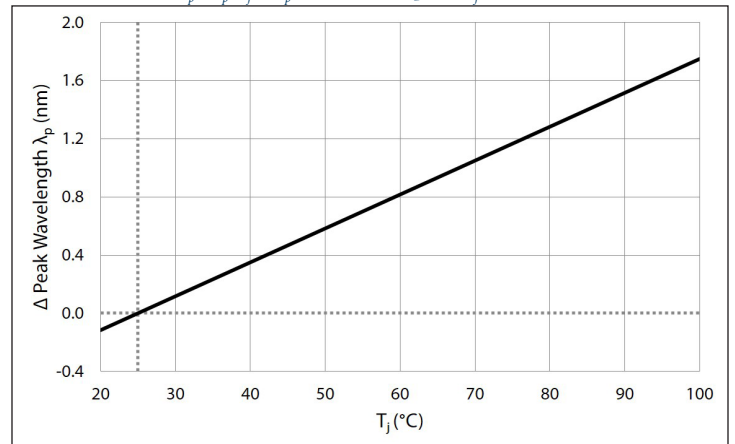

### Forward Voltage vs Forward Current

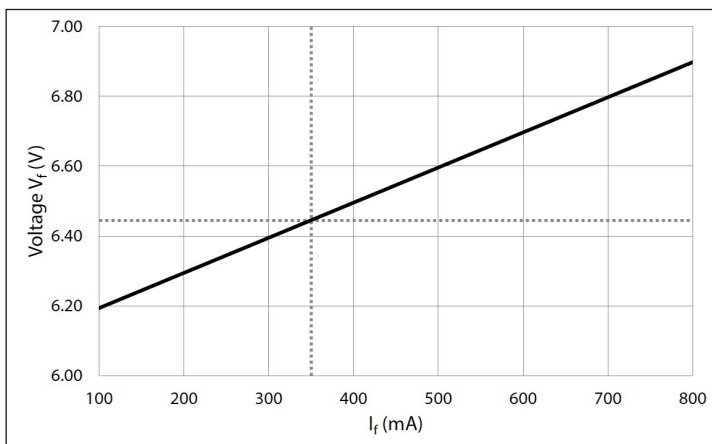

### Forward Voltage Shift vs. Junction Temperature

$\Delta V_f = V_f(T_j) - V_f(25^\circ\text{C})$ , 20 ms pulse,  $I_f = 350\text{ mA}$

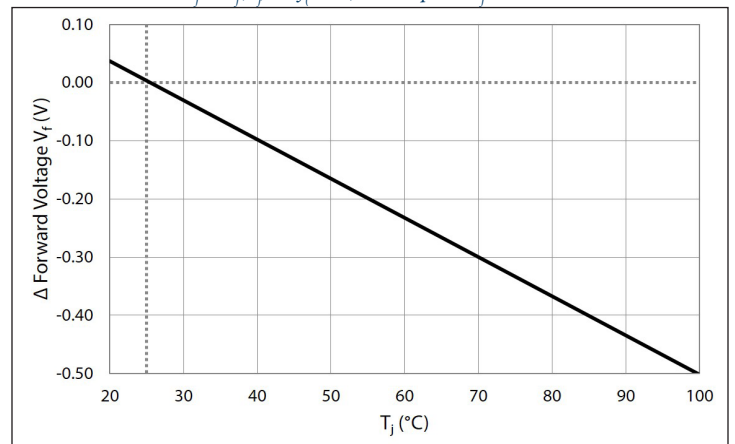

### Typical Spectrum

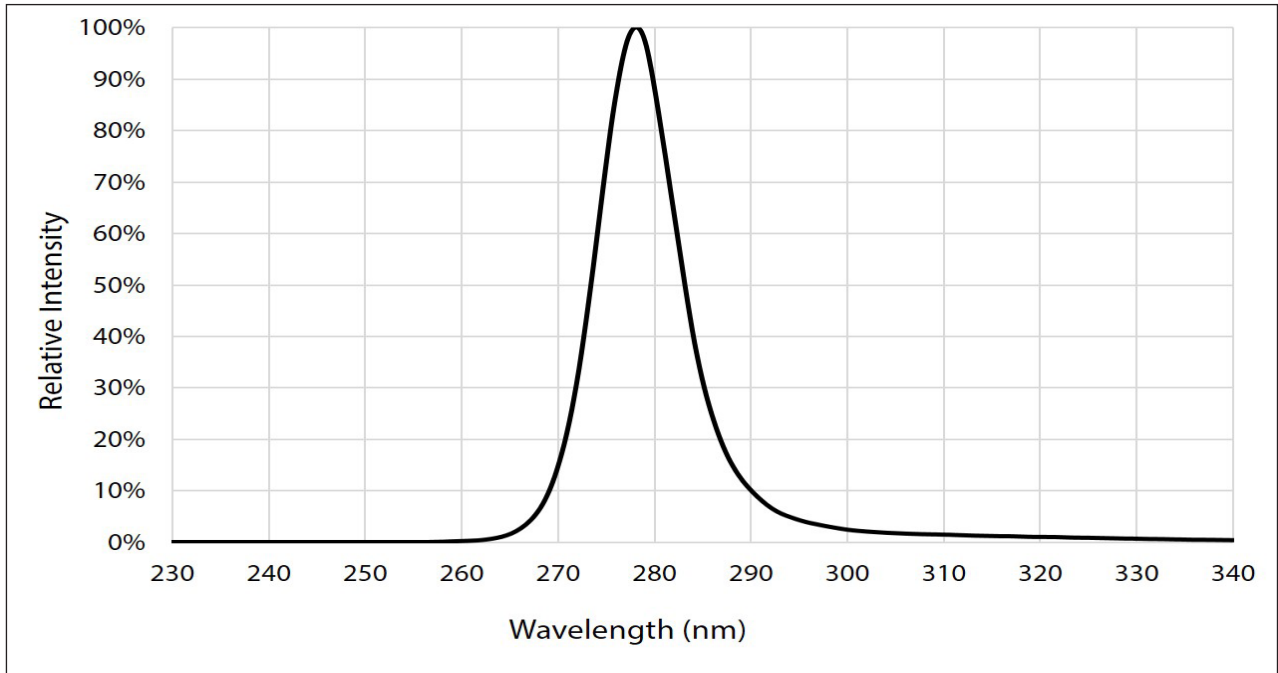

### Radiation Pattern

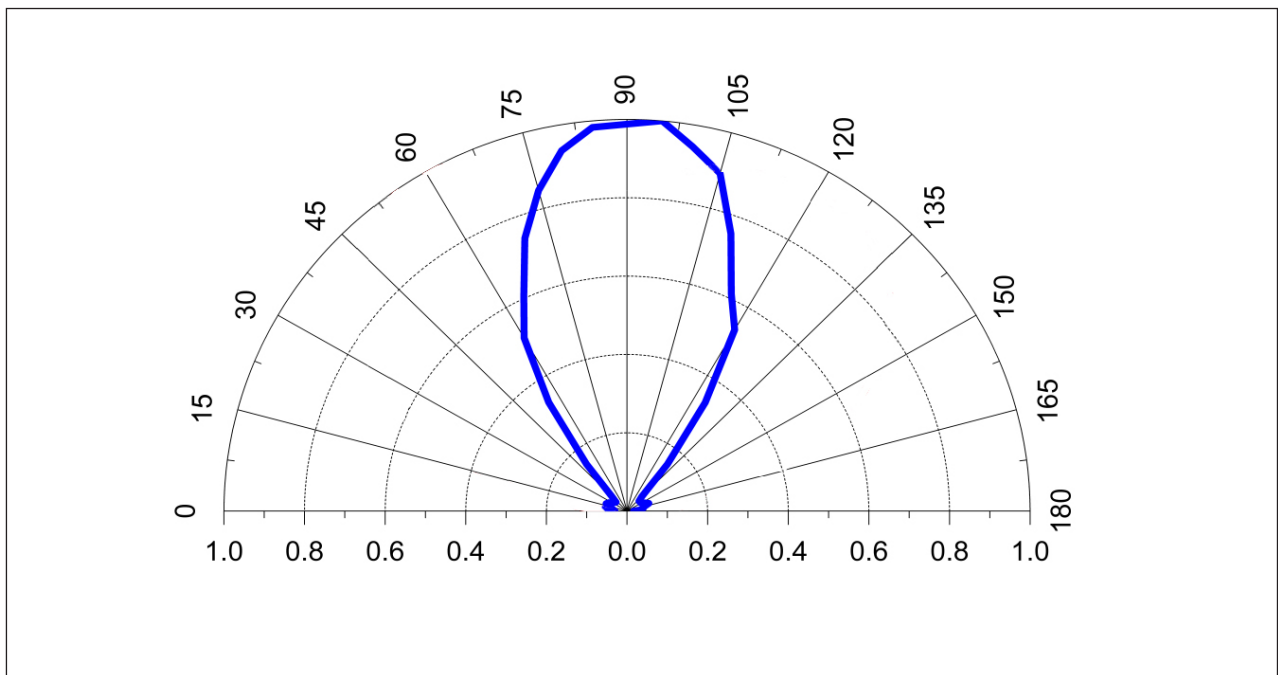

### Mechanical Dimensions

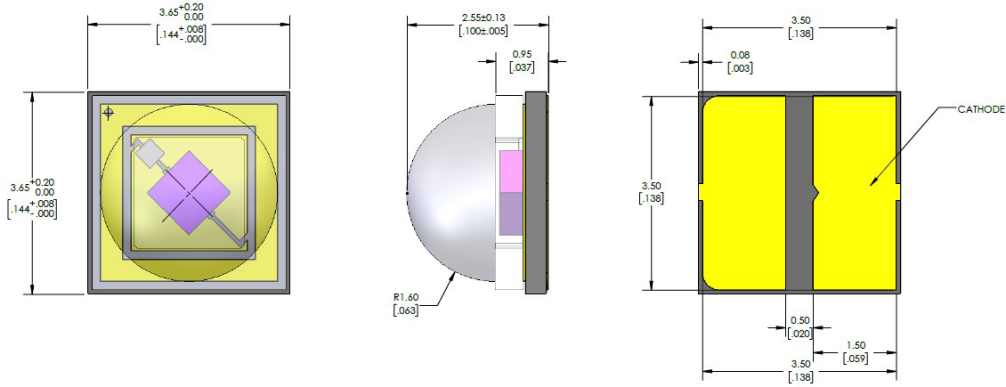

### Recommended Solder Pad and Stencil Pattern

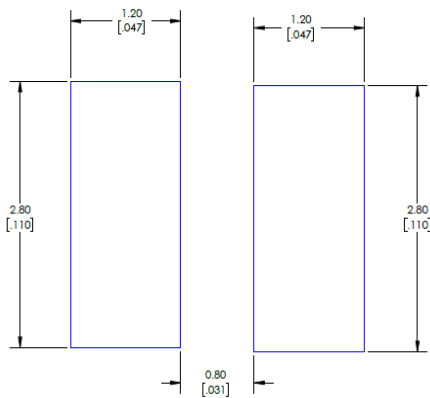

**Recommended Stencil Pattern**

Solder Pad	3.6 mm x 1.6 mm
Stencil Pattern	2.8 mm x 1.2 mm

### Soldering Profile

Profile Setting	Pb-Free Profile
Average Ramp-up Rate ( $T_{s_{max}}, T_p$ )	1 °C/sec
Preheat Temperature Min ( $T_{s_{min}}$ )	100-150 °C
Preheat Temperature Max ( $T_{s_{max}}$ )	180-200 °C
Preheat Time ( $t_{s_{min}}$ to $t_{s_{max}}$ )	60-120 sec
Liquidus Temperature ( $T_L$ )	217 °C
Time Maintained Above $T_L$ ( $t_L$ )	50-80 sec
Peak / Classification Temperature ( $T_p$ )	260 °C
Time within 5°C of Actual Peak Temp ( $t_p$ )	Max 10 sec
Ramp-Down Rate	2-3 °C /sec
25°C to Peak Temperature time	4 mins

Luminus recommends that users follow the recommended soldering profile provided by the manufacturer of the solder paste used. Note that this general guideline may not apply to all PCB designs and configurations.

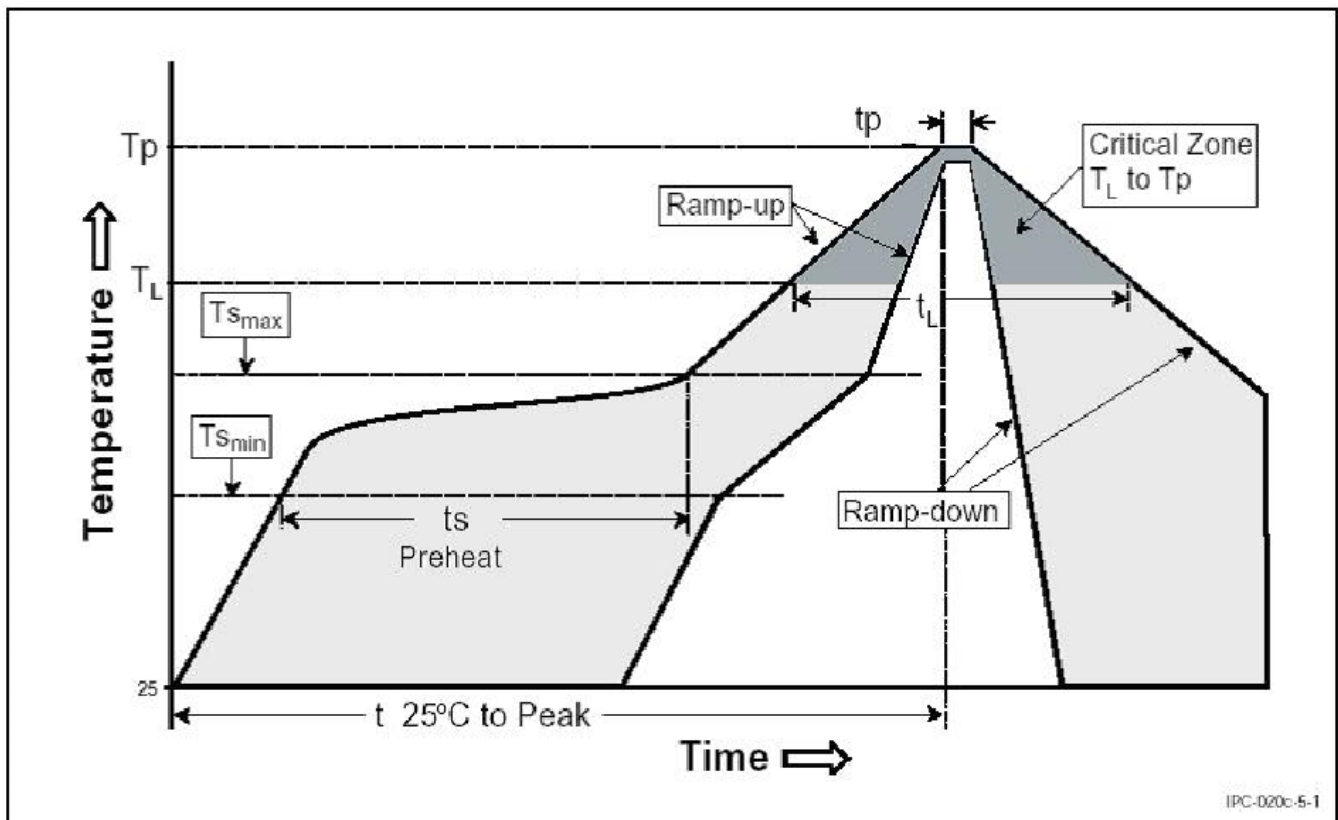



## Product Shipping & Labeling Information

All XST-3535 products are packaged and labeled with their respective bin as outlined in the tables on pages 2 & 3. Each reel will only contain one flux and one wavelength bin

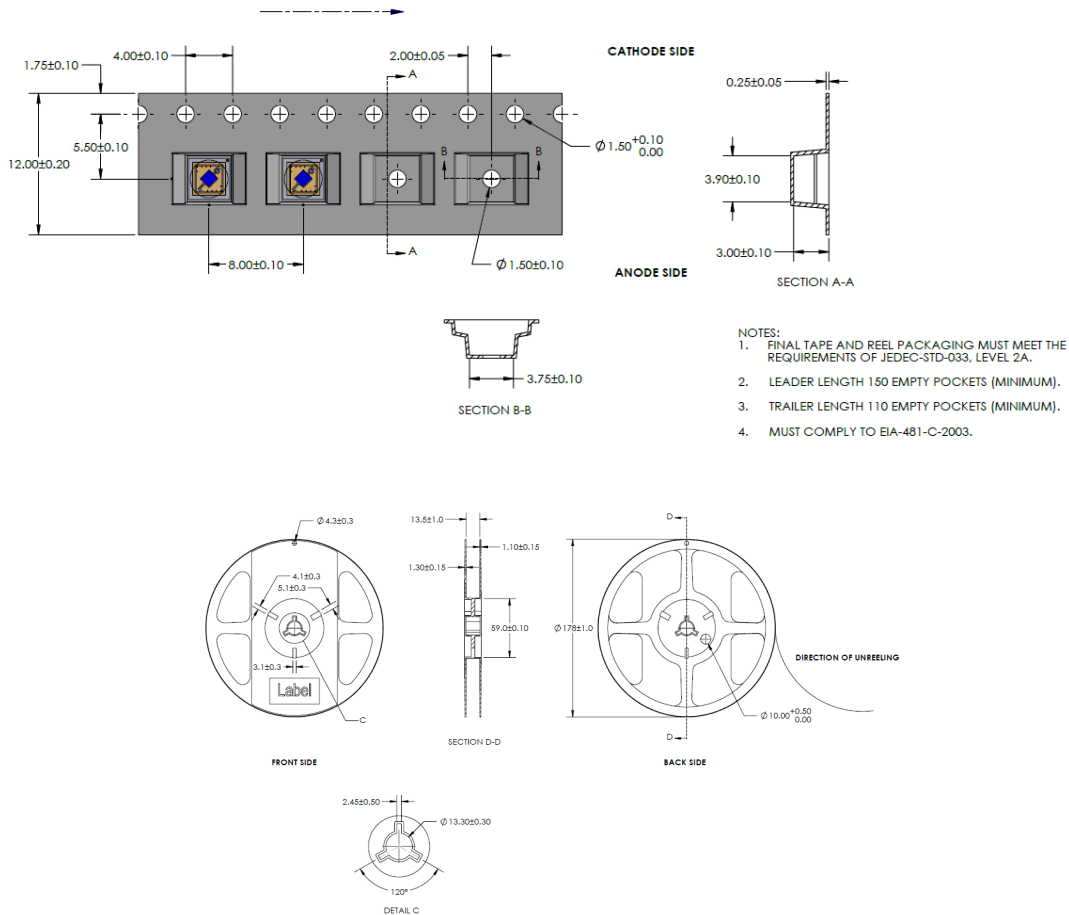

## XST-3535-UV Label Information

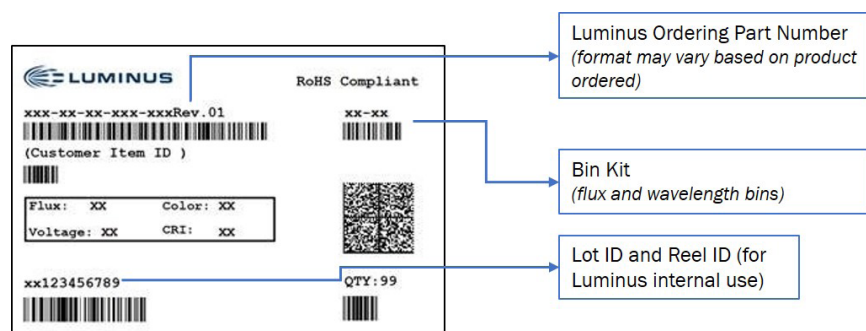

## Precautions for storage, handling and use of UV LEDs

### 1. UV Light

XST-3535-UV LEDs are short wavelength, deep UV LEDs. During operation, the LED emits high intensity UVC radiation, which is harmful to skin and eyes. UV light is also hazardous to skin and may cause cancer. Avoid exposure to deep UV light when LED is operational.

Precautions must be taken to avoid looking directly at the UV light without the use of UV light protective glasses. Do not look directly at the front or at the LED's lens when LED is operational.

### 2. Static Electricity (ESD)

While XST 3535 LEDs have built-in Zener protection diodes, they are particularly sensitive to ESD (Electrostatic Discharge). Static electricity and surge voltages seriously damage UV LEDs and can result in complete failure of the device. Precautions must be taken against ESD when handling or operating these devices.

### 3. Operating Conditions

In order to ensure the correct functioning of these LEDs, compliance to maximum allowed specifications is important. UV LEDs are particularly sensitive to drive currents that exceed the max operating specifications and may be damaged by such drive currents. The use of current regulated drive circuits is strongly recommended when operating these devices. Customers should also provide adequate thermal management to ensure LEDs do not exceed maximum recommended temperatures. Operating LEDs at temperatures in excess of specification will result in damage and possibly complete failure of the device.

### History of Changes

Rev		Description of Change
01	06/11/2019	Initial release
02	11/04/2019	Tape and Reel drawing
03	04/04/2020	Additional ordering part numbers introduced, increased max current rating
03	05/19/2020	Editorial change- spectrum reflects 275 nm Bins
04	06/17/2020	Defined higher bin (CH: 55-60 mW)
05	11/2020	New wavelength bins and Vf bins introduced. Updated drawing

