

SUMMARY

Wires

Low voltage 3



Image is for illustrative purpose only

Series 00
Termination type Female solder
IP rating 68
AWG wire size 34.00 - 28.00
Cable Ø 1.30 - 4.40 mm
Status active

Download

[Request a quote](#)

[Catalog](#)

TECHNICAL DETAILS

Mechanics

Shell Style/Model HG*: Fixed receptacle, nut fixing, watertight or vacuum-tight
Keying 1 key (alpha=0, plug: male contacts, receptacle: female contacts)
Housing Material Brass (black chrome) shell and collet nut, nickel plated [SAE AMS QQ N 290] brass latch sleeve and mid pieces
Variant P : Watertight
Weight 3.66 g

Performance

Configuration 00.303 : 3 Low Voltage
Insulator L: PEEK (UL 94 / V-0/1.5)
Rated Current 3 Amps

Specifications

Contact Type: Solder
Contact Dia.: 0.5 mm (0.02in)
Bucket Dia.: 0.4 mm (0.016in)
Max. Solid Conductor: 0.09 mm² (AWG 28)
Max. Stranded Conductor: 0.05 mm² (AWG 30)
R (max): 8.7 mOhm

LEMO products and services are provided "as is". LEMO makes no warranties or representations with regard to LEMO product & services or use of them, express, implied or statutory, including for accuracy, completeness, or security. The user is fully responsible for his products and applications using LEMO components.

Vtest (contact-shell): 950 V (AC), 1300 V (DC)
 Vtest (contact-contact): 800 V (AC), 1100 V (DC)

Others

Temp (min / max): -20°C / +100°C
 Salt Spray Corrosion: >1000 hr
 Pressure: 60 bars

DRAWINGS

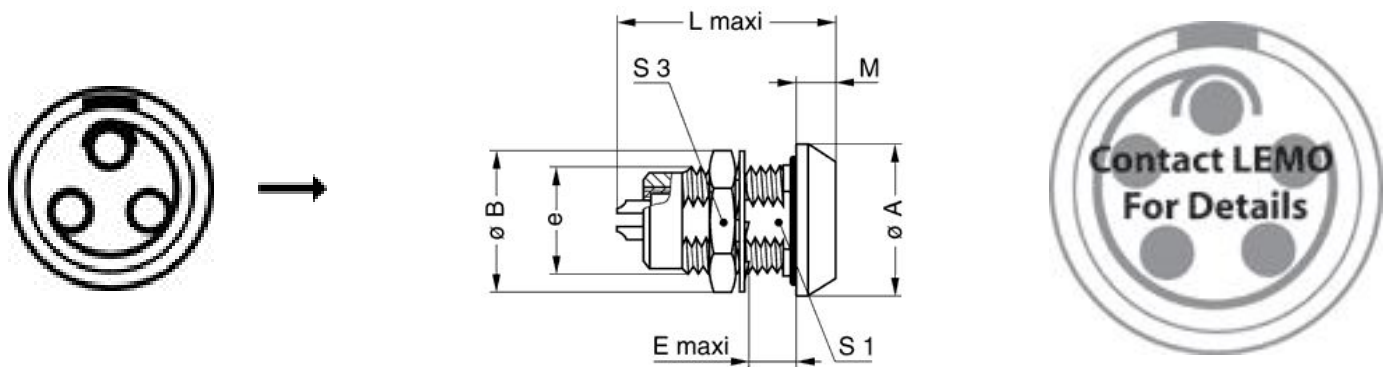

Dimensions

	A	B	E	L	M	S3	e
mm.	11	10.3	8	18	1.5	9	M7x0.5
in.	0,43	0,41	0,31	0,71	0,06	0,35	







RECOMMENDED BY LEMO

Tools

Cables

CMN.03.B12.113PLZ			
CMN.03.T28.031PGCE	PVC	GREY	

LEMO products and services are provided "as is". LEMO makes no warranties or representations with regard to LEMO product & services or use of them, express, implied or statutory, including for accuracy, completeness, or security. The user is fully responsible for his products and applications using LEMO components.

CMN.03.T28.031PGZE		Grey	
CMN.03.T28.031PNCE	PVC	Black	
CMN.03.T28.031PNZE			
30110	PVC	Grey	
3041	PVC	Grey	
3050	PVC	Black	
3081	PVC	Black	
3280	PVC	Black	
60080	PVC	Grey	

LEMO products and services are provided "as is". LEMO makes no warranties or representations with regard to LEMO product & services or use of them, express, implied or statutory, including for accuracy, completeness, or security. The user is fully responsible for his products and applications using LEMO components.