



TAOGLAS®



Datasheet

GPSF.36.7.A.30

Part No:
GPSF.36.7.A.30

Description:

GPS L1/L2, GONASS G1, Bei Dou B1 And Galileo E1
36mm Single Feed Stacked Patch
Passive Antenna Low AR

Features:

Highest Accuracy
Low Axial Ratio
GPS L1+L2 Band Operation
GLONASS G1
Galileo E1
Bei Dou B1
Single Feed Patch Assembly
Dimensions: 36*36*7mm
Tuned for Centre Positioning on a 70*70mm
Ground-plane

1. Introduction	3
2. Specifications	4
3. Antenna Characteristics	7
4. Radiation Patterns	12
5. Mechanical Drawing – Antenna	14
6. Antenna Integration Guide	15
7. Mechanical Drawing – Evaluation Board	20
8. Packaging	21
<hr/>	
Changelog	22

Taoglas makes no warranties based on the accuracy or completeness of the contents of this document and reserves the right to make changes to specifications and product descriptions at any time without notice. Taoglas reserves all rights to this document and the information contained herein. Reproduction, use or disclosure to third parties without express permission is strictly prohibited.



1. Introduction

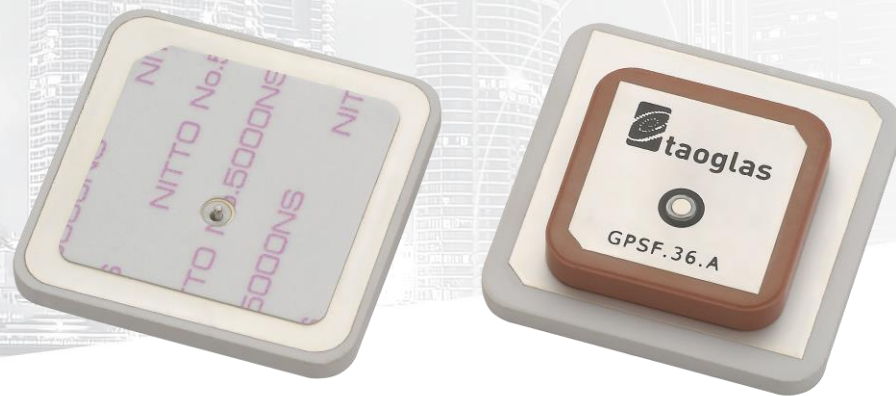

The GPSF.36.7.A.30 is a 36x36mm ceramic low profile, low axial-ratio, embedded stacked passive patch antenna with a 7mm height. It is designed as a high performance yet economical solution for highest accuracy centimeter level tracking in telematics applications and covers:

- GPS L1/L2,
- Galileo E1,
- GLONASS G1
- Bei Dou B1

Typical applicable industries are

- UAVs and Drones
- Transportation
- Autonomous Vehicles
- Marine
- Agriculture
- Navigation

This compact antenna exhibits excellent gain and radiation pattern stability on covered bands, improved reliability of a GPS fix in urban areas, better signal reception with more satellites acquired, and a quicker time to first fix.

The antenna has been tuned and tested on a 70 X 70 mm ground plane. It can be easily through-hole mounted on PCB via pin. The double-sided adhesive on the bottom of the patch helps to keep it in place while being assembled.

For further optimization to customer specific device environments, a custom tuned patch antenna and circuit integration service into your device can be supplied, subject to NRE and MOQ. Contact your regional Taoglas customer support team for this requirement, and for support to integrate and test this antenna's performance in your device.

2. Specifications

GNSS Frequencies Covered					
GPS	L1	L2	L5		
	■	■	□		
GLONASS	G1	G2	G3		
	■	□	□		
Galileo	E1	E5a	E5b	E6	
	■	□	□	□	
BeiDou	B1	B2a	B2b	B3	
	■	□	□	□	
QZSS (Regional)	L1	L2C	L5	L6	
	■	■	□	□	
IRNSS (Regional)	L5				
	□				
SBAS	L1/E1/B1	L5/B2a/E5a	G1	G2	G3
	■	□	■	□	□

*SBAS systems: WASS(L1/L5), EGNOS(E1/E5a), SDCM(G1/G2/G3), SNAS(B1,B2a), GAGAN(L1/L5), QZSS(L1/L5), KAZZ(L1/L5).

Electrical		
	GPS L1	GPS L2
Center Frequency	1575.42 MHz	1227.60 MHz
Return loss (dB)	< -10	< -10
Efficiency (%)	91.30	67.57
Peak Gain (dBi)	5.44	3.10
Axial Ratio at Zenith (dB)	1.69	2.70
Impedance	50 Ohm	
Polarization	RHCP	

Mechanical		
	GPS L1	GPS L2
Ceramic Dimension	25*25*4mm	36*36*3 mm
Pin Diameter	0.80 mm	
Pin Length	2.40 mm	
PCB Dimension	70*70 mm	
Weight	23.4g	

Environmental	
Operation Temperature	-40°C to 85°C
Humidity	Non-condensing 65°C 95% RH

*Tested on square 70*70 mm ground-plane.

Field Test Result with 70*70mm ground plane

Frequency	GPS L1	GPS L2	Galileo E1	GLONASS G1	BeiDou B11
	1563-1587	1215-1239.6	1559-1591	1598-1605	1559-1563
Carrier-to-Noise Values(dB-Hz)	43.3	35.6	40.2	37.8	40
2*DRMS Positioning Accuracy (cm) without RTK	150	150	150	150	150
2*DRMS Positioning Accuracy (cm) with RTK	12	12	12	12	12
TTF(s)	33	33	33	33	33
Group Delay @ Zenith Variation Across Single Constellation(ns)	2.2	12	2	20	2.2
Phase Centre Offset PCO (cm)	4	4.6	4	4	4
Phase Centre Variation PCV (mm)	0.5	0.4	0.8	0.8	0.7
Axial Ratio (dB)	2	10	8	16	5.5

*All outdoor measurements performed on the roof top of the Taoglas R&D Labs facility in Dublin Ireland.

** Recommended Minimum C/No for Standard Precision Acquisition/ Tracking (dB-Hz): 26-30/ 12-15.

***Data Measured Free Space.

****Group Delay, PCO, PCV and Axial Ratio values includes Active Circuitry.

*****Ublox C099-F9P application board is used for Field test Measurements.

RTK AVAILABILITY

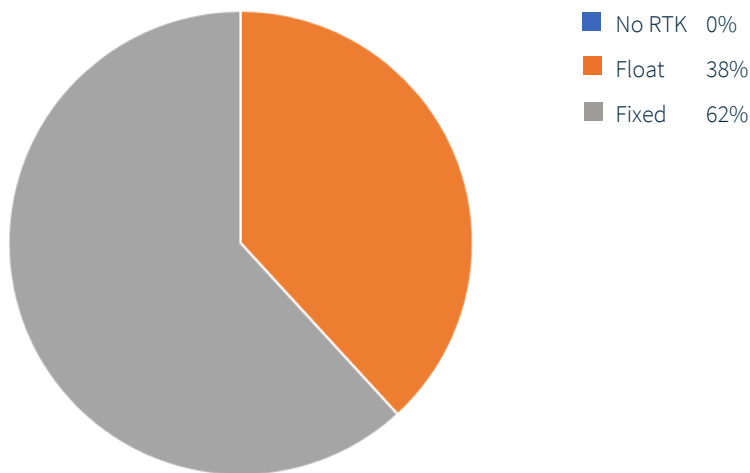

3. Antenna Characteristics

3.1 Return Loss

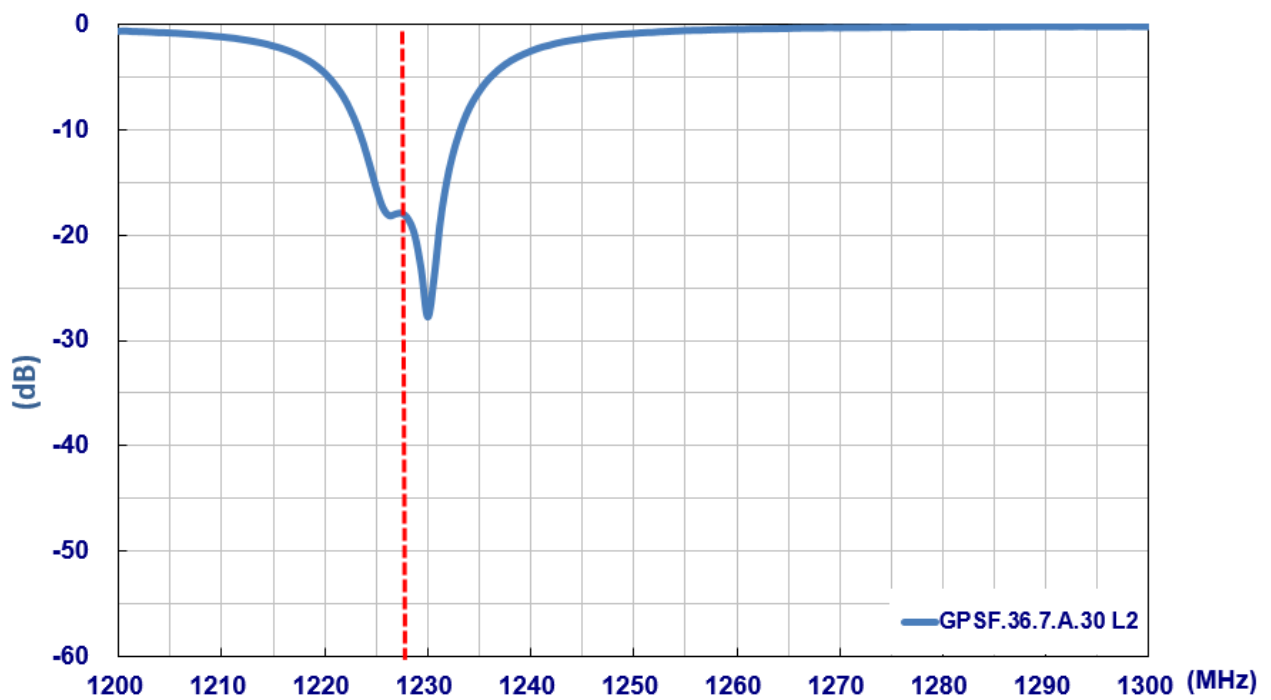
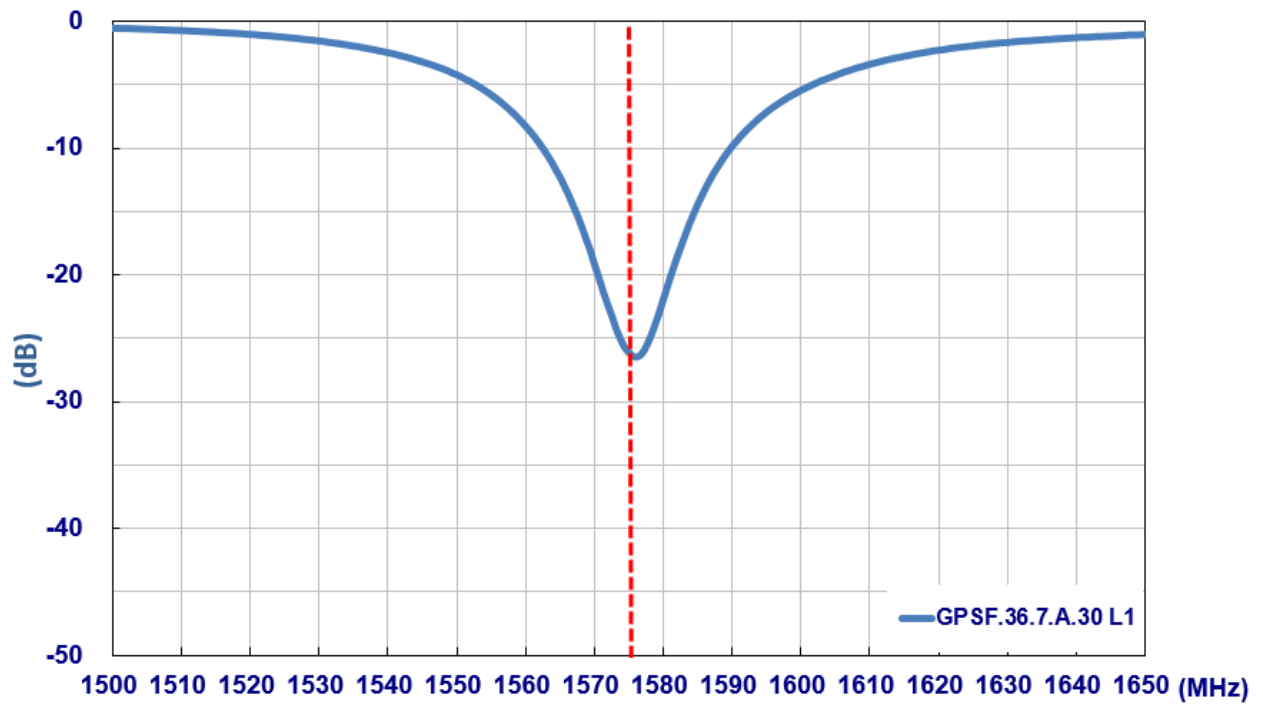

3.2 Efficiency

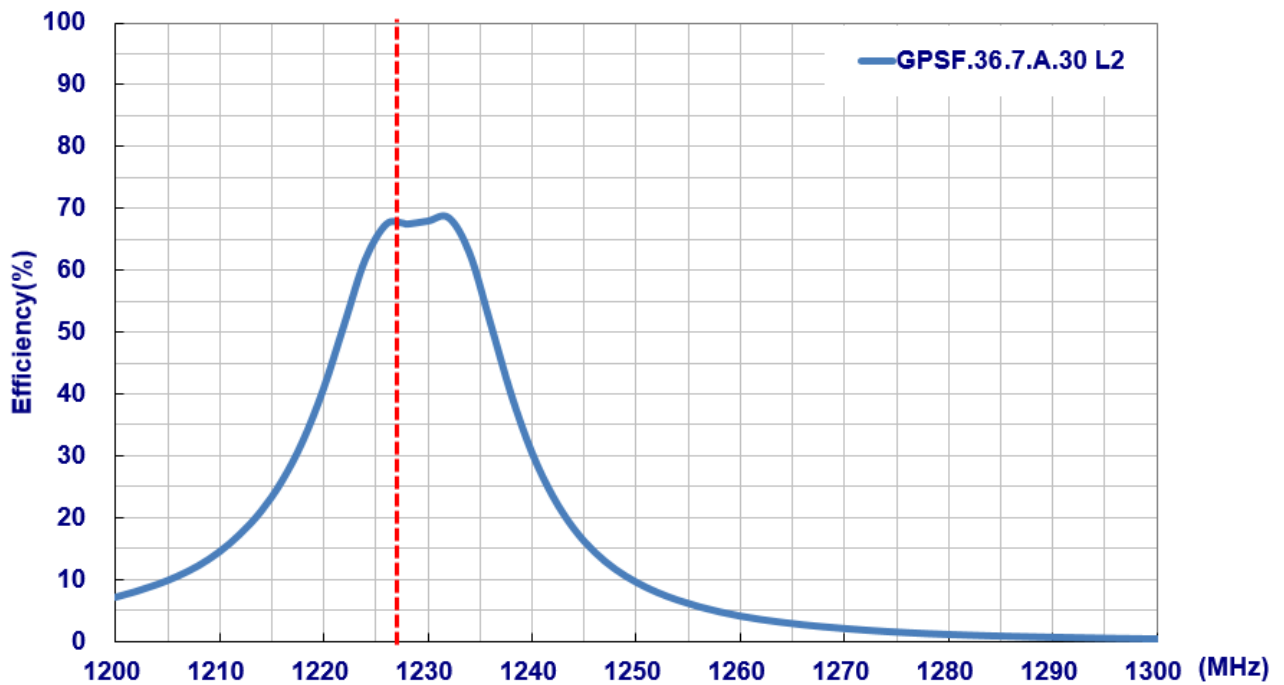
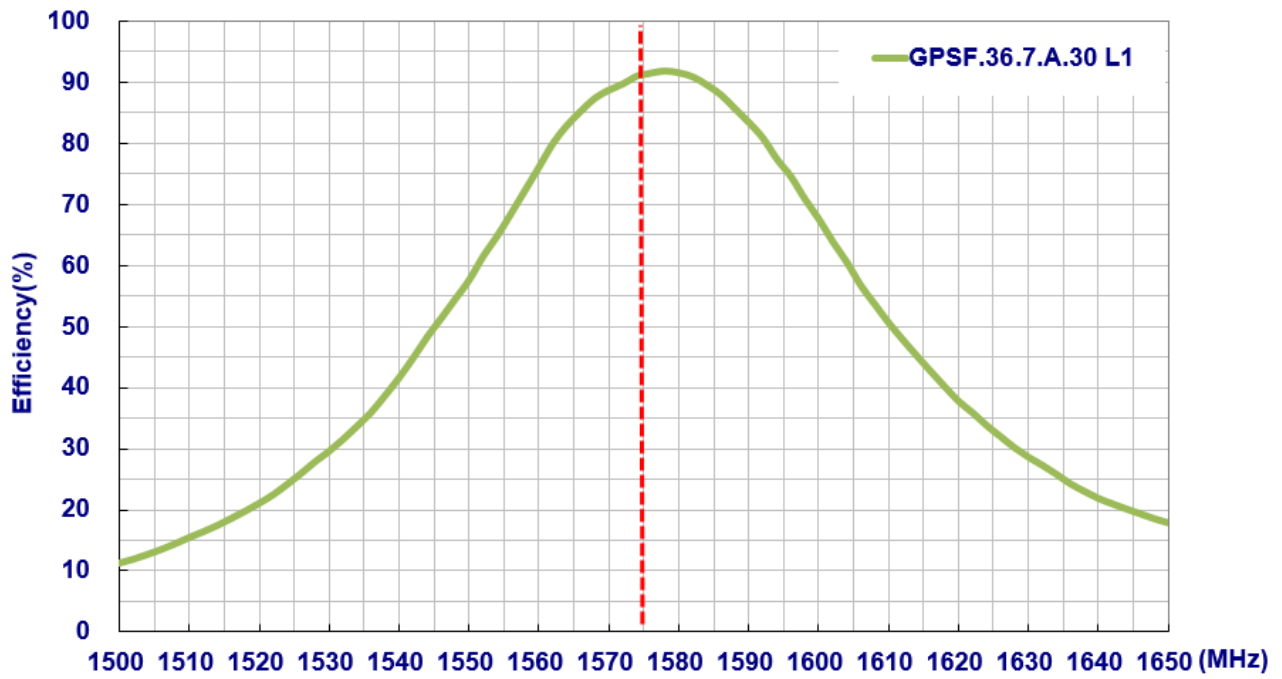

3.3 Peak Gain

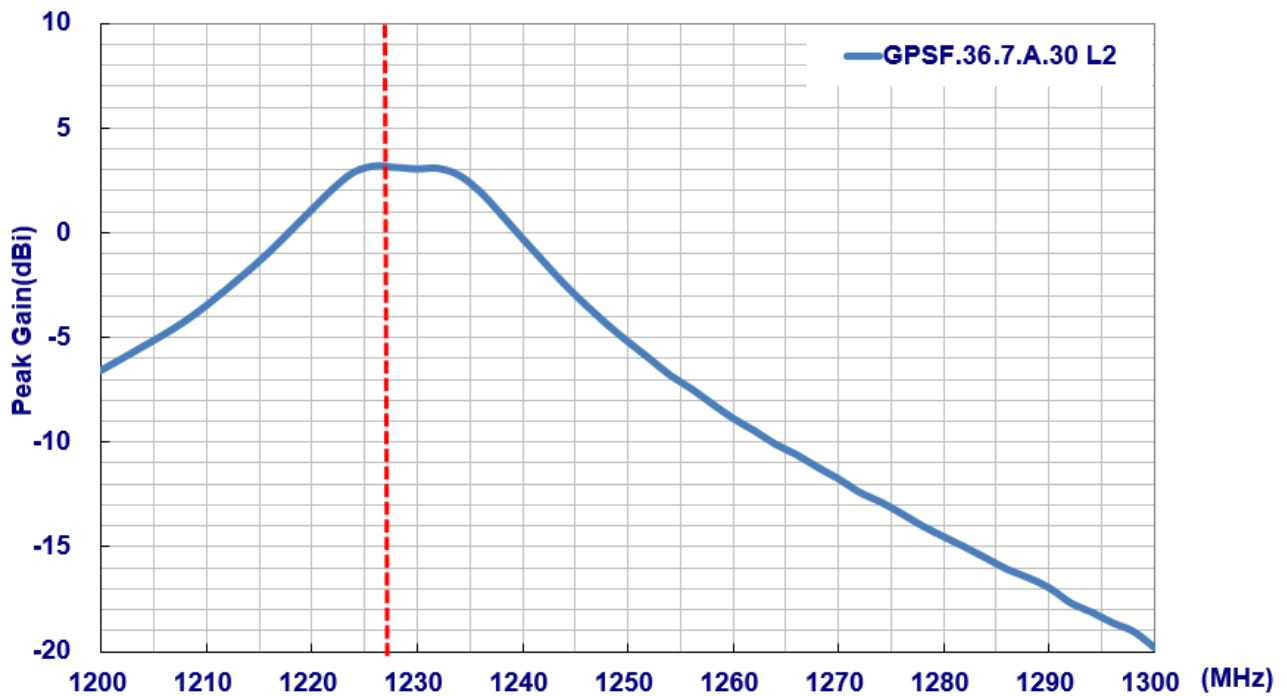
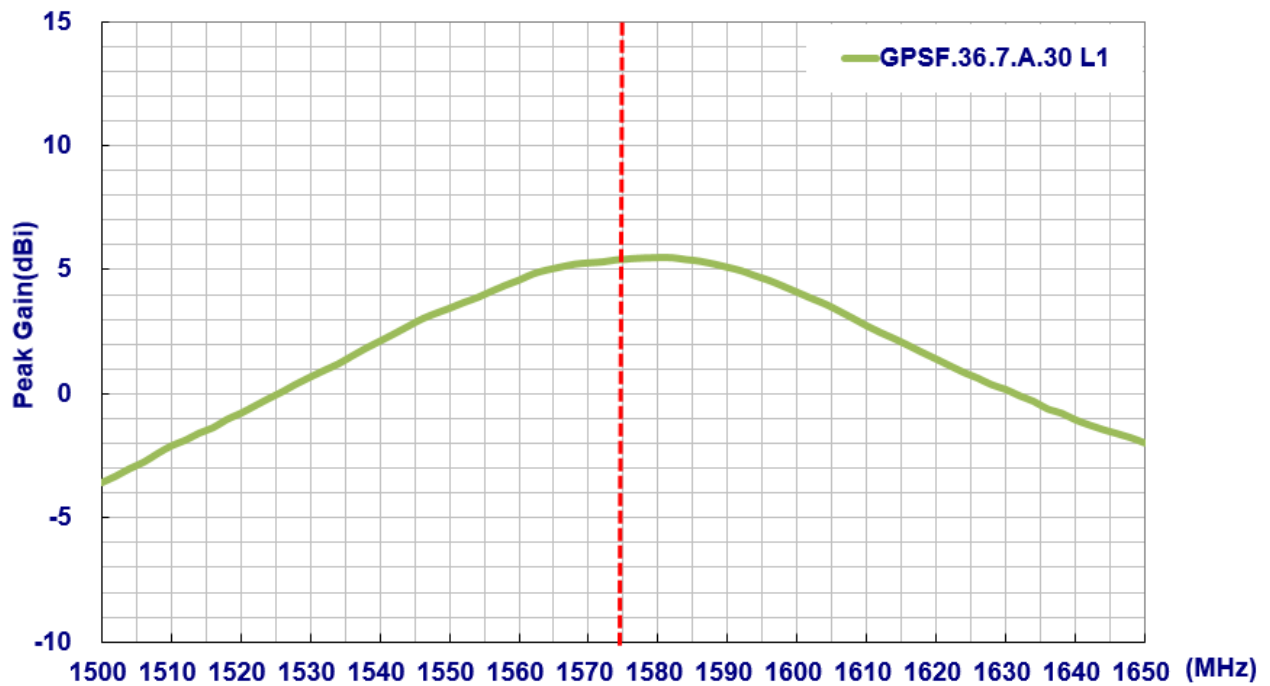

3.4 Average Gain

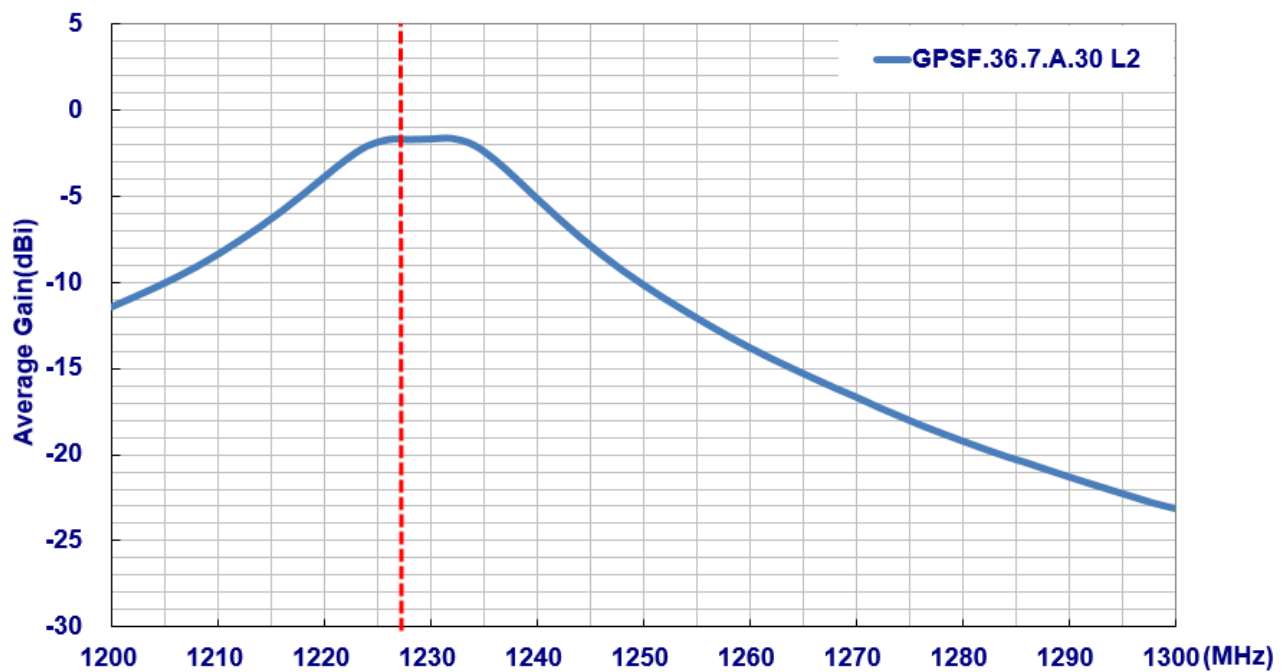
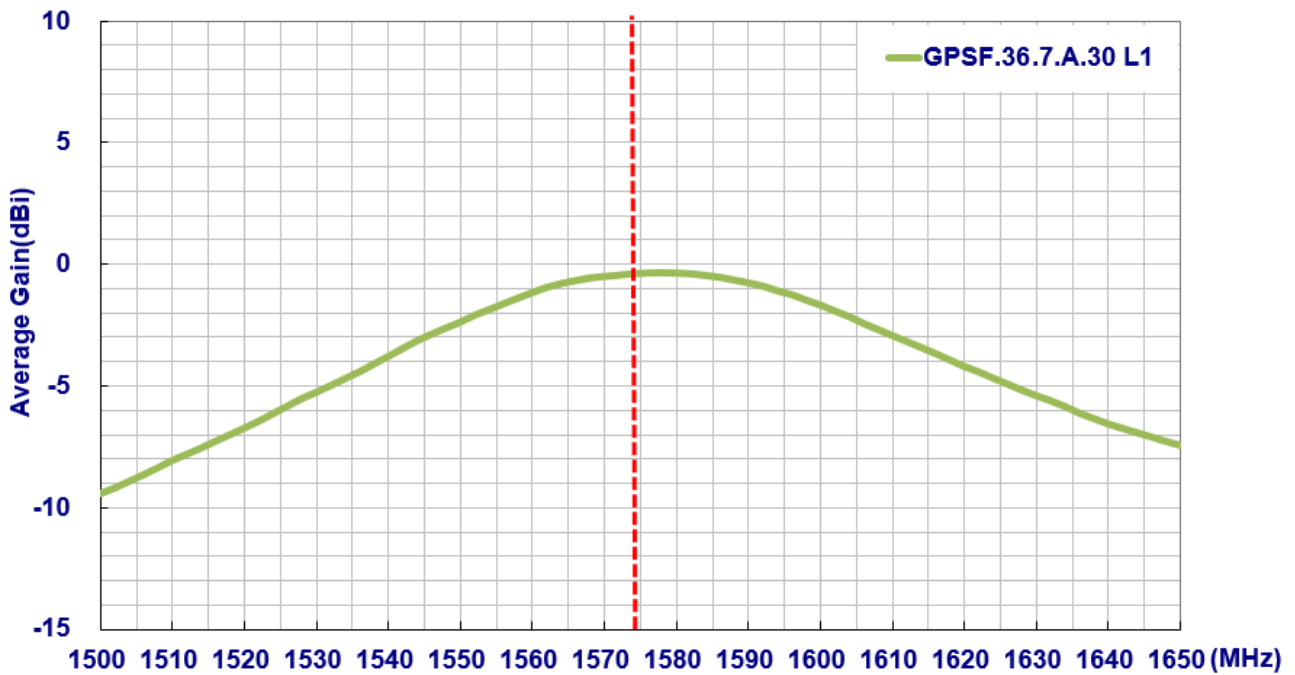

3.5 Axial Ratio

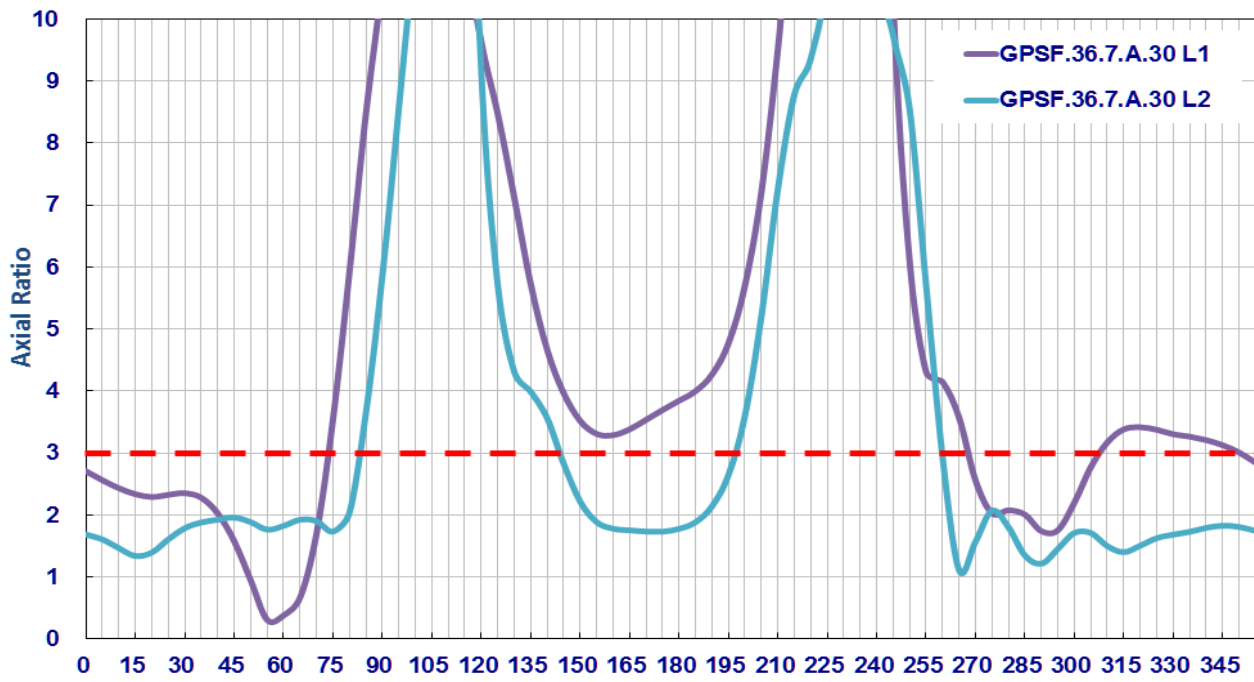

4. Radiation Patterns

4.1 Test Setup

The GPSF.36.7.A.30 antenna is tested in free-space on a 70 mm X 70 mm ground plane in an Anechoic Chamber. The test setup is shown below.

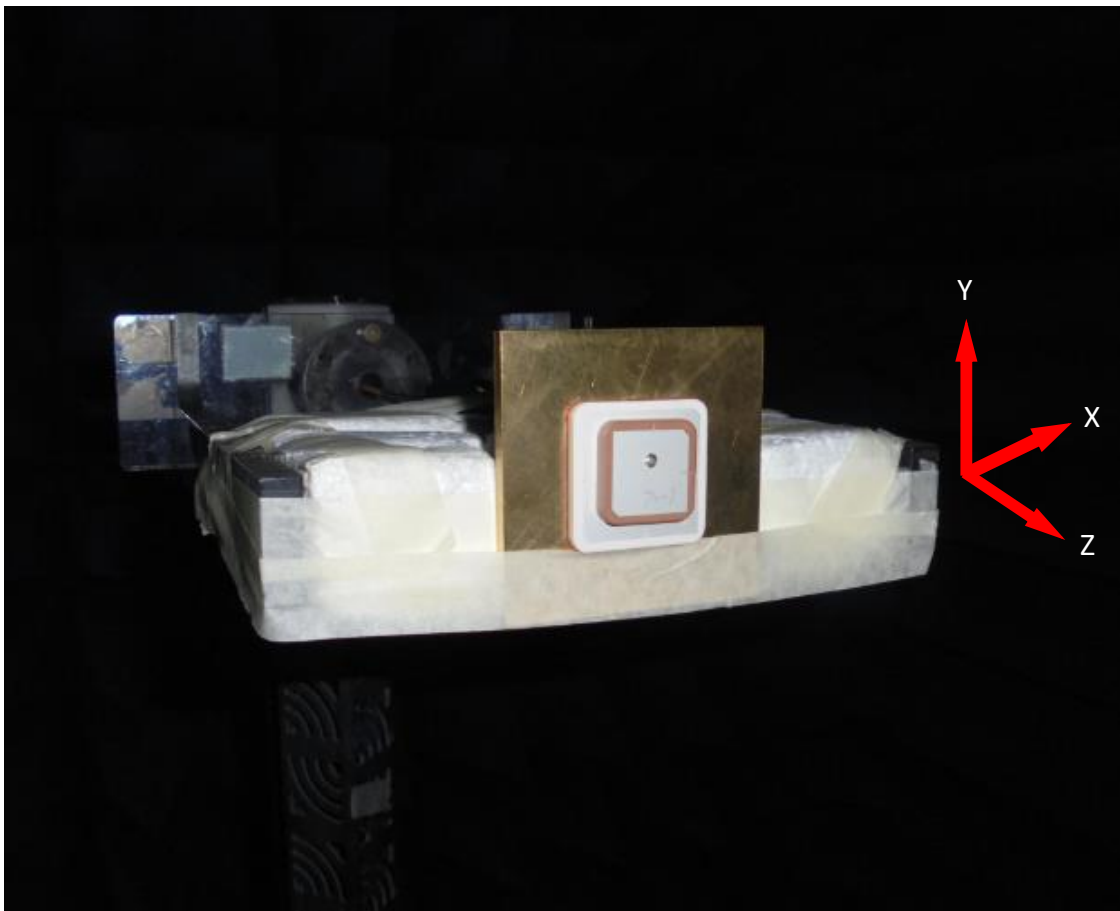

4.2 3D and 2D Radiation Patterns

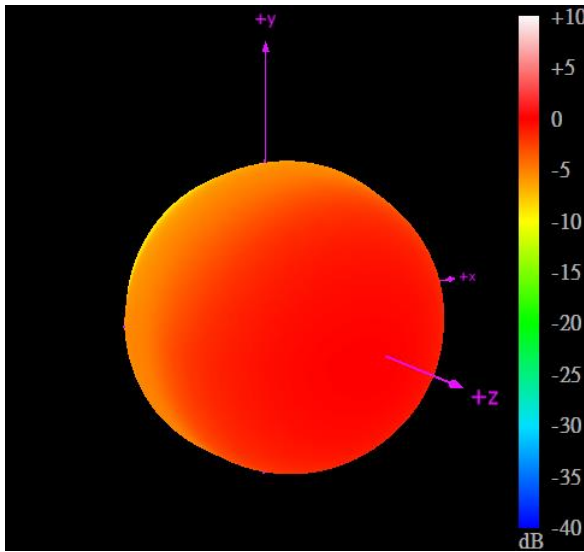

L1 1575.42MHz

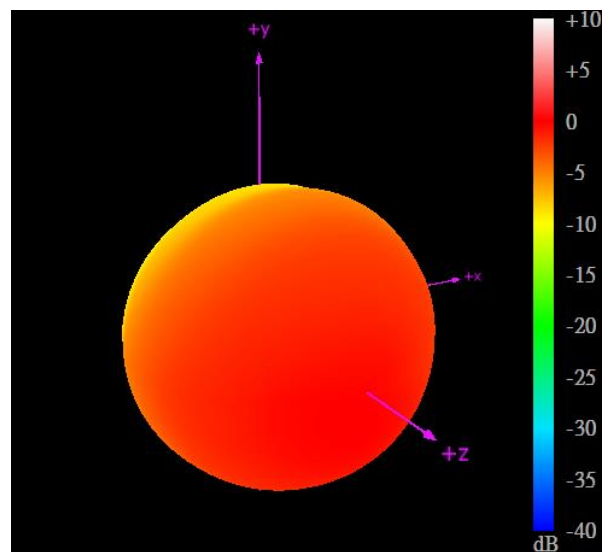

L2 1227.6MHz

XY Plane XZ Plane YZ Plane

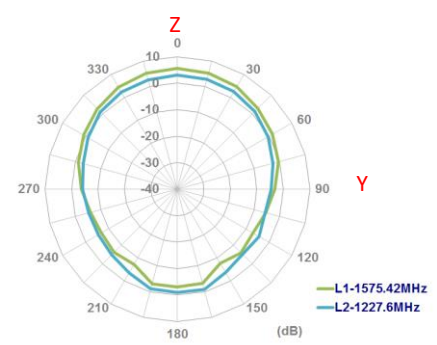
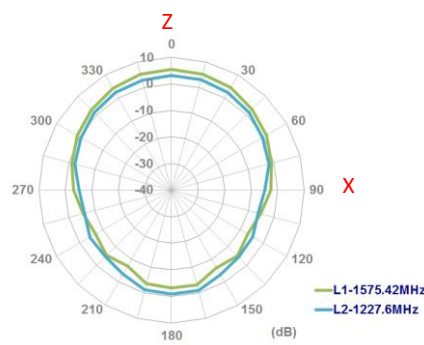
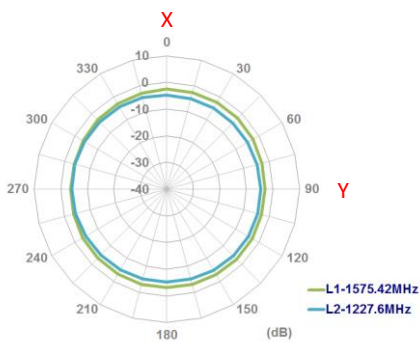

5. Mechanical Drawing – Antenna (Units: mm)

ISO NO.: EDW-18-8-1041
 STATE: Release
 NOTES:

REV.	DESCRIPTION	ENG.	APPROVED	DATE
A	Initial Design	Eva	Paul	2018/10/03
B	Change Pin and Solder Point Dimensions. (EDW-18-8-201)	Bonnie	Haley	2019/01/30
C	EC-21-08-010	Mickey	Buluto	2021/03/02

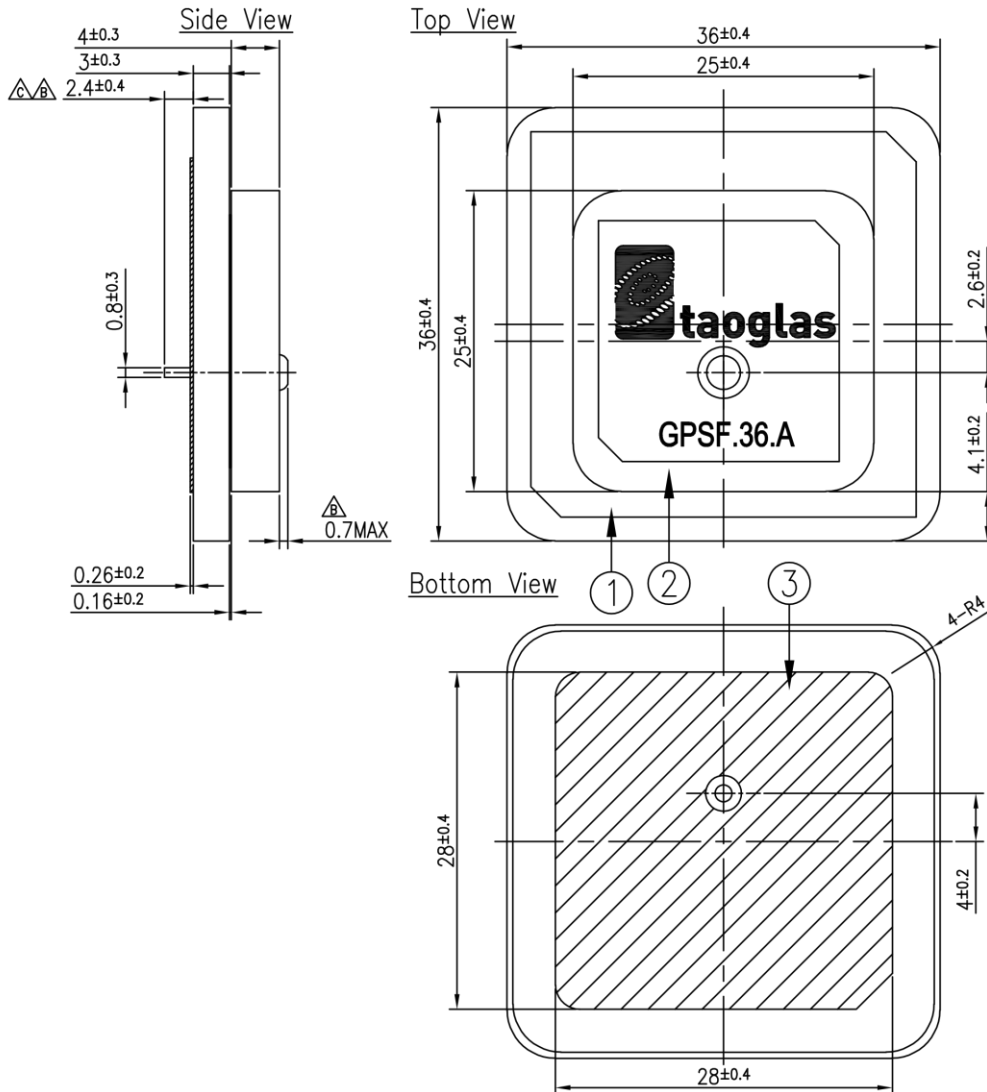

	Name	P/N	Material	Finish	QTY
1	Patch(36*36*3mm)	0015180030058A	Ceramic	White	1
2	Patch(25*25*4mm)	0015180020058A	Ceramic	Reddish Brown	1
3	Double sided Adhesive	0010180020000A	NITTO 5000MS	White Liner	1

APPROVED BY: Wayne	 <small>TW Design Centre This drawing and its inherent design concepts are property of Taoglas. Not to be copied or given to third parties without the written consent of Taoglas.</small>
CHECK BY: Jack/Paul	
DRAWN BY: Kim	
DATE: 2016/03/18	TITLE : GPS Single Feed Stacked Patch Antenna L1:1575MHz L2:1227MHz 36*36*7mm
UNLESS OTHERWISE SPECIFIED TOLERANCES ON: XX±0.5 X±0.3 X±0.2 XX±0.1 XXX±0.05	PART NO. : GPSF.36.7.A.30
THIRD ANGLE PROJECTION	UNIT: mm SCALE: 2:1 PAGES: 1/1 REV: C

6. Antenna Intergration Guide

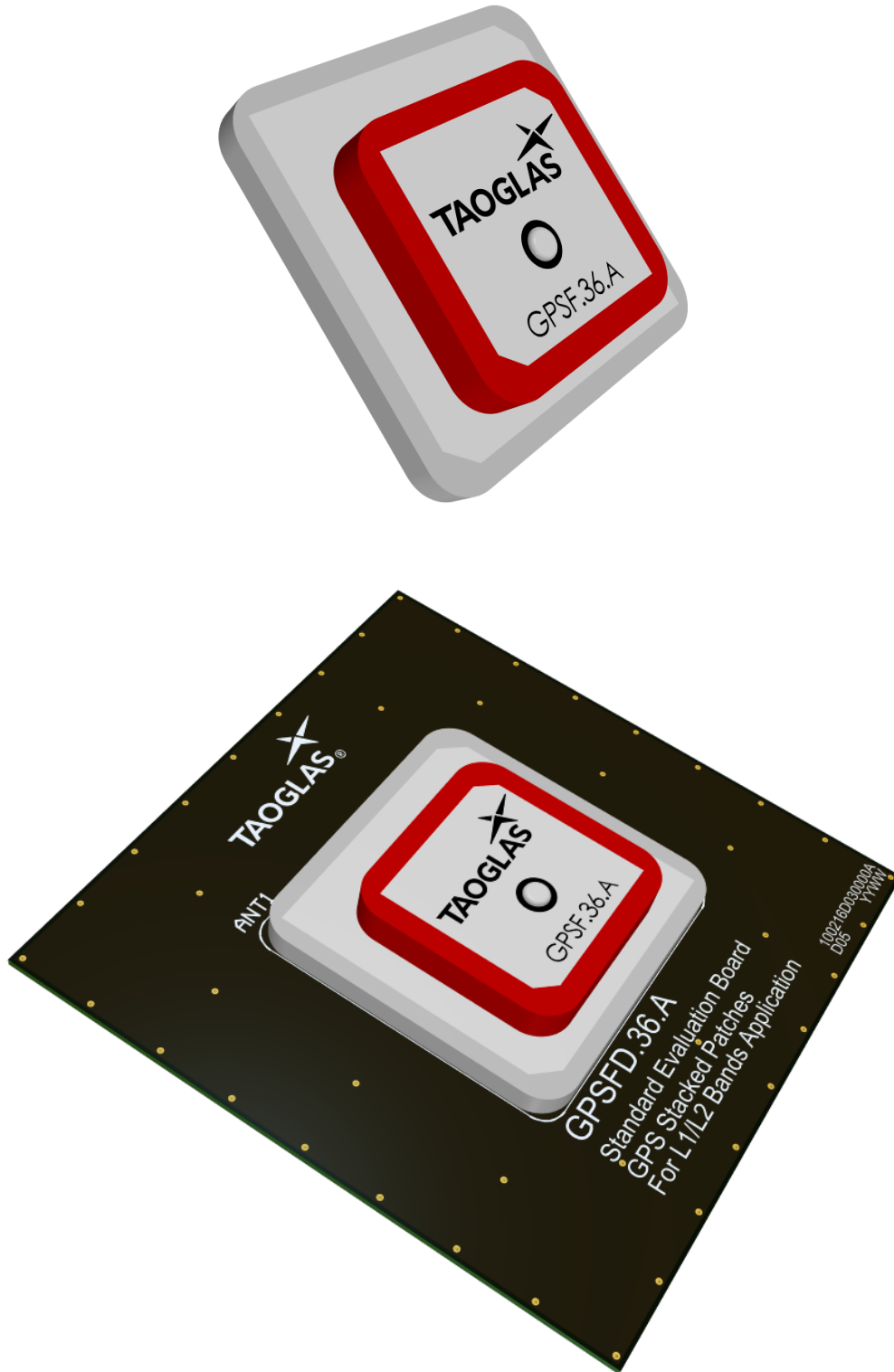

6.1 Schematic Symbol and Pin Definition

The circuit symbol for the antenna is shown below. The antenna has 1 pin as indicated below.

Pin	Description
1	RF Feed

GPSF.36.7.A.30
ANT1

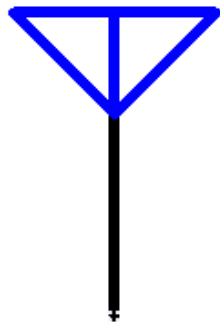

6.2 Antenna Integration

The antenna should be placed at the center of the ground plane with a length and width of 70mm. Maintaining a square symmetric ground plane shape and symmetric environment around the antenna is critical to maintaining the excellent axial ratio and phase center performance shown in this datasheet.

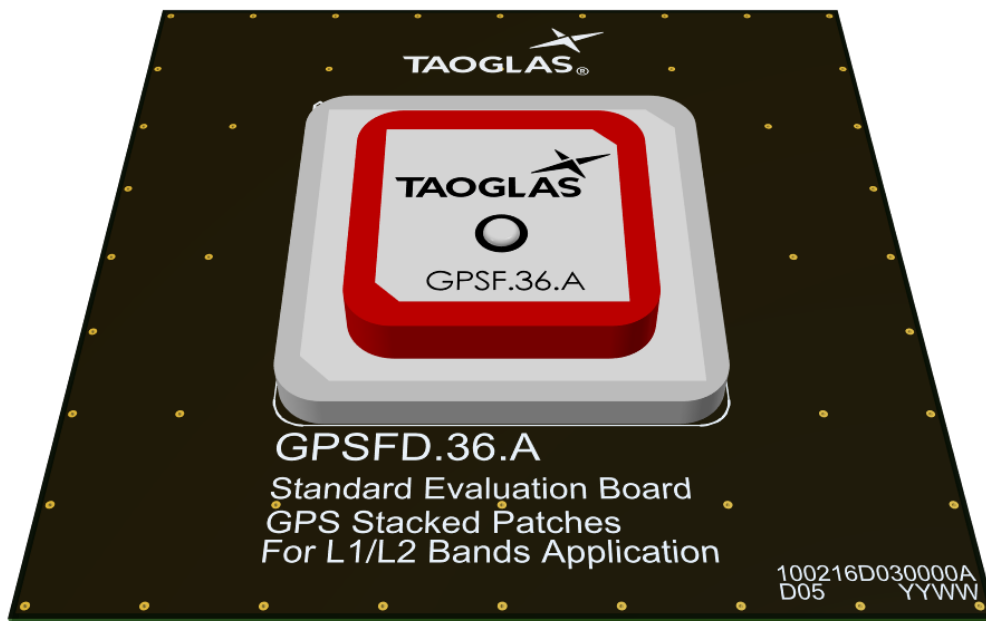

Top Side w/ Solder Mask

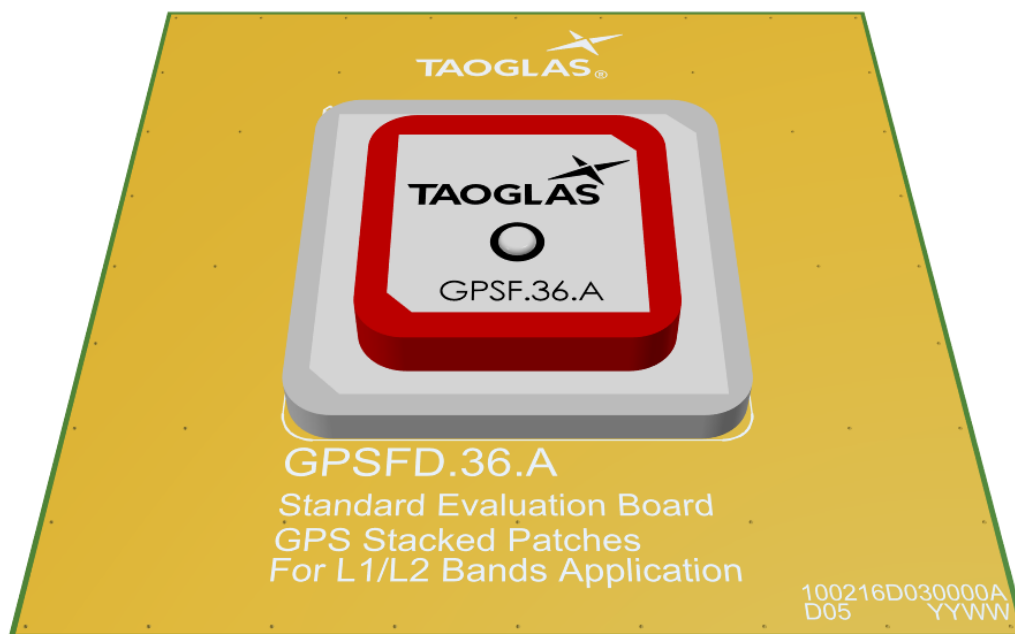

Top Side w/o Solder Mask

6.3 PCB Layout

The footprint and clearance on the PCB must comply with the antenna specification. The PCB layout shown in the diagram below demonstrates the antenna footprint.

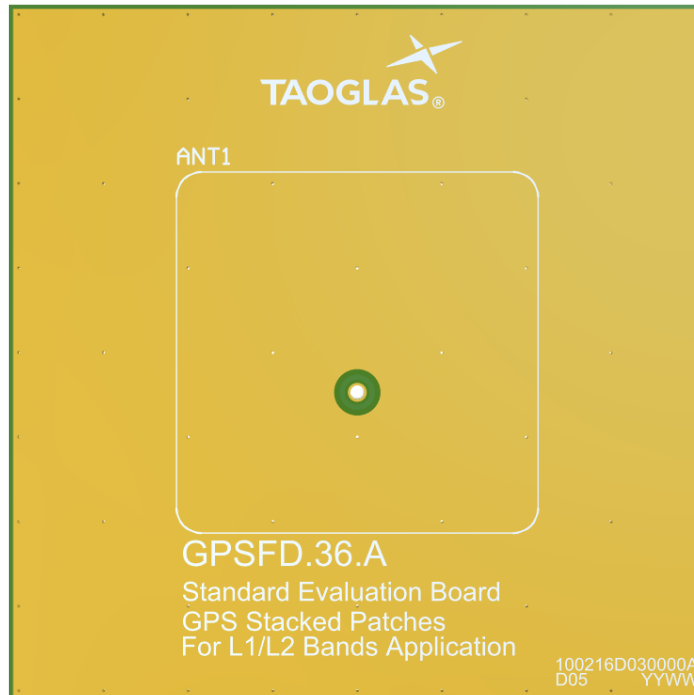

Topside

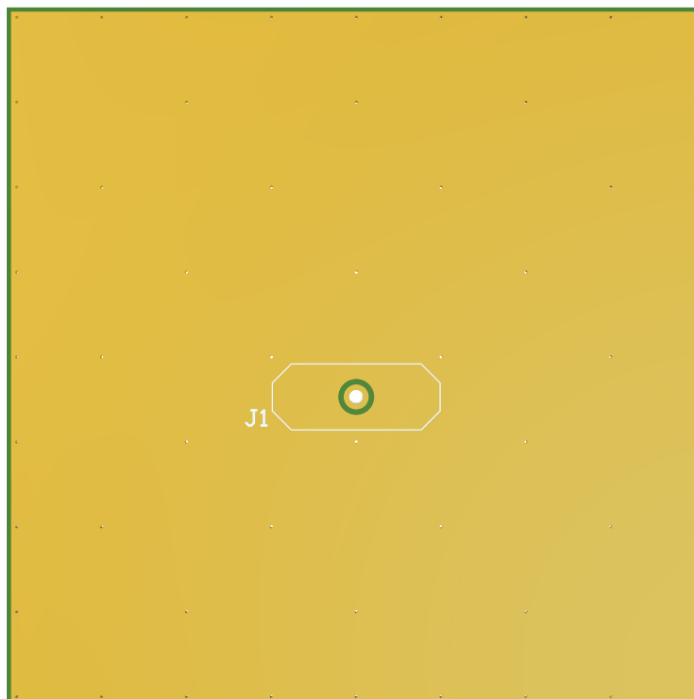

Bottom Side

6.5 Evaluation Board

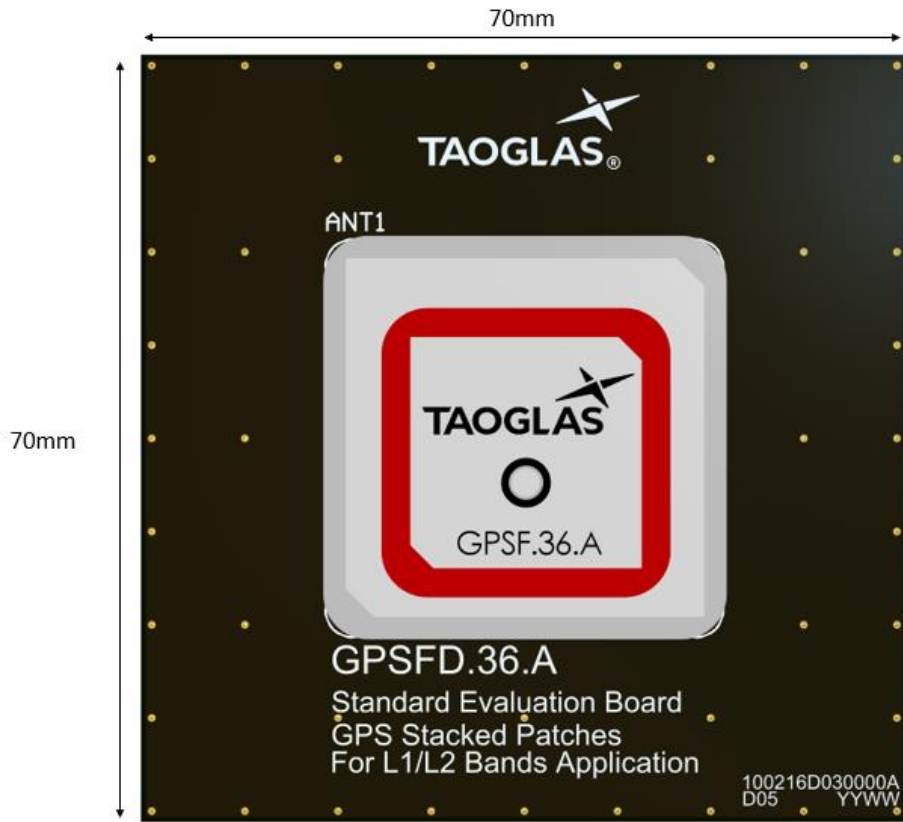

Topside

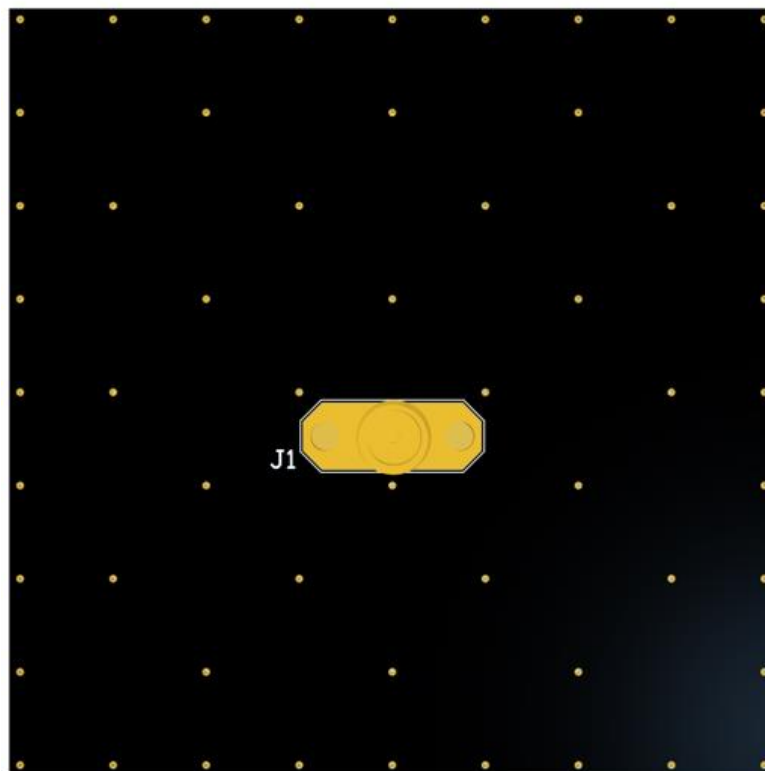

Bottom Side

7. Mechanical Drawing – Evaluation Board

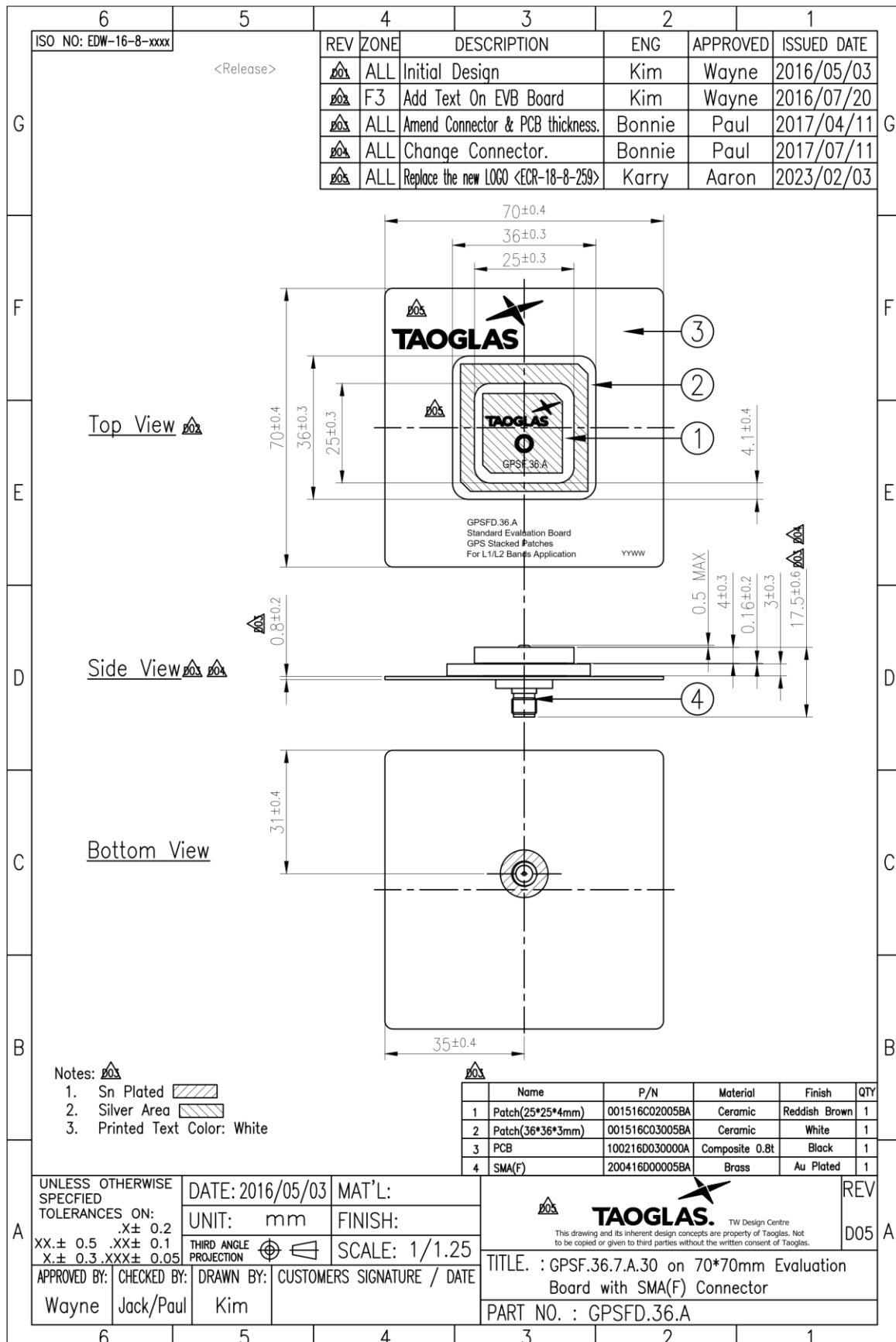

8. Packaging

Packaging Specifications

25 pcs GPSF.36.7.A.30 per tray
 Each tray in vacumed PE bag
 Tray Dimensions - 340*340*27mm
 Weight - .7Kg per tray

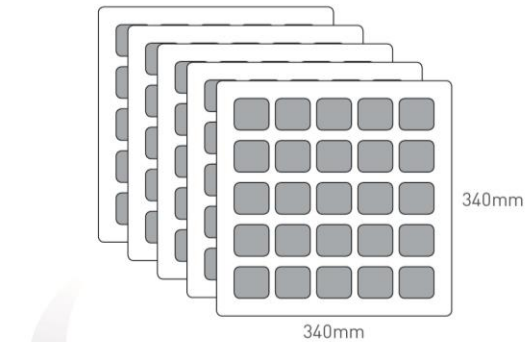

8 Trays per Carton - 200 pcs
 Carton Dimensions - 250*250*120mm
 Weight - 5.5Kg

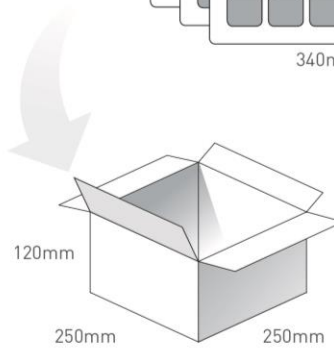

400 pcs - Carton Dimensions - 500*260*125mm
 Weight - 12Kg

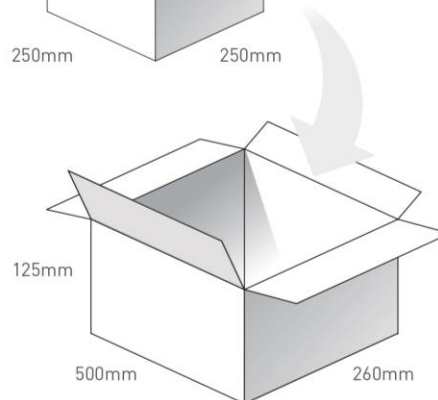

Pallet Dimensions 1200*1000*1500mm
 80 Cartons per Pallet
 10 Cartons per layer
 8Layers

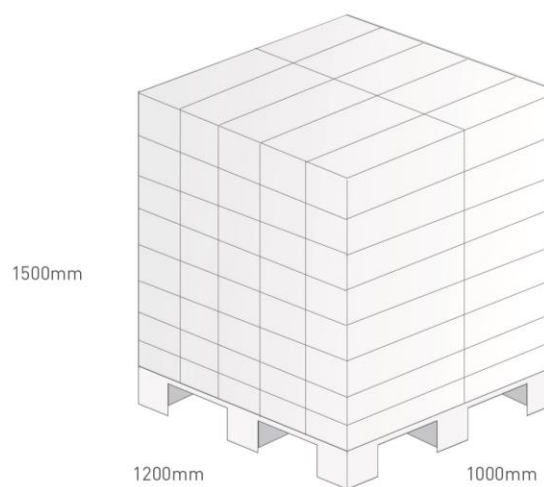

Changelog for the datasheet

SPE-17-8-027 - GPSF.36.7.A.30

Revision: F (Current Version)

Date:	2021-07-08
Changes:	Updated cover page and spec table (band coverage)
Changes Made by:	Gary West

Previous Revisions

Revision: E

Date:	2021-07-08
Changes:	Updated cover page and spec table (band coverage)
Changes Made by:	Gary West

Revision: D

Date:	2021-06-19
Changes:	Updated Pin Length to 2.4mm Updated Drawing
Changes Made by:	Dan Cantwell

Revision: C

Date:	2019-12-08
Changes:	Amended GNSS data and drawing
Changes Made by:	Jack Conroy

Revision: B

Date:	2019-12-08
Changes:	Added GNSS Frequency Bands Matrix and RTK Test Data
Changes Made by:	Yu Kai Yeung

Revision: A (Original First Release)

Date:	2017-03-05
Notes:	Initial Release
Author:	Wayne Yang



TAOGLAS®

www.taoglas.com

