

Device Features

- OIP3 = 44.0 dBm @ 70 MHz
- Gain = 15.2 dB @ 70 MHz
- Output P1 dB = 20.0 dBm @ 70 MHz
- Patented temperature compensation
- Patented over voltage protection
- RoHS2-compliant SOT-89 SMT package



Product Description

BeRex's BIF1 is a high performance InGaP/ GaAs HBT MMIC amplifier, internally matched to 50 Ohms and uses a patented **temperature compensation** circuit to provide stable current over the operating temperature range without the need for external components and a patented **over voltage protection** circuit to protect a internal device. The BIF1 is designed for high linearity IF amplifier that requires excellent gain, high OIP3 and flatness. It is packaged in a RoHS2-compliant with SOT-89 surface mount package.

Applications

- Base station Infrastructure/RFID
- Commercial/Industrial/Military wireless system

Applications Circuit

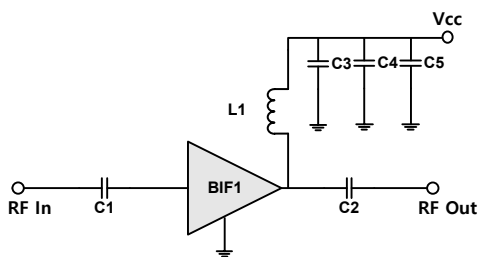

*C1, C2=8200pF ± 5%; C3 = 100 pF ± 5%; C4 = 1000pF ±5%

*C5 = 10uF; L1 = 1200nH ±5%

Electrical Specifications

Device performance _ measured on a BeRex evaluation board at 25°C, Vc=5V, 50 Ω system.

Parameter	Conditions	Min	Typ	Max	Unit
Operational Frequency Range		5		800	MHz
Test Frequency			70		MHz
Gain		13.7	15.2		dB
Input Return Loss			-18.0		dB
Output Return Loss			-16.0		dB
Output IP3	10 dBm / tone , Δf=1 MHz	41.0	44.0		dBm
Output P1dB		19.0	20.0		dBm
Noise Figure			4.2		dB

Recommended Operating Conditions

Parameter	Min	Typ	Max	Unit
Bandwidth	5		800	MHz
I _c @ (V _c = 5V)	84	105	126	mA
V _c	3.5	5.0	5.25	V
dG/dT		-0.001		dB/°C
R _{TH}		50		°C/W
Operating Case Temperature	-40		+85	°C

Electrical specifications are measured at specified test conditions.

Specifications are not guaranteed over all recommended operating conditions.

Absolute Maximum Ratings

Parameter	Rating	Unit
Storage Temperature	-55 to +155	°C
Junction Temperature	+180	°C
Supply Voltage	+6.0	V
Supply Current	180	mA
Input RF Power	23	dBm

Operation of this device above any of these parameters may result in permanent damage.

Above 7V, a device goes to protection mode.

5-800 MHz Internally Matched IF Amplifier

Typical Performance (Vd = 5V, Ic = 105mA, T = 25°C)

Freq	MHz	70	140	250	500	800
S21	dB	15.2	15.2	15.1	15.0	14.7
S11	dB	-18.0	-18.0	-18.0	-18.0	-19.0
S22	dB	-16.0	-17.0	-16.0	-15.0	-13.0
P1	dBm	20.0	20.8	20.9	21.0	20.7
OIP3	dBm	44.0	42.0	40.5	40.0	37.5
NF	dB	4.2	4.3	4.3	4.4	4.5

Typical Performance (Vd = 4.7V, Ic = 87mA, T = 25°C)

Freq	MHz	70	140	250	500	800
S21	dB	15.2	15.2	15.1	15.0	14.8
S11	dB	-18.6	-20.4	-21.6	-23.3	-25.6
S22	dB	-11.9	-14.6	-15.6	-14.1	-10.9
P1	dBm	18.9	19.5	19.4	19.8	19.3
OIP3	dBm	42.5	38.5	41.0	38.0	34.9
NF	dB	4.2	4.3	4.3	4.4	4.5

Typical Performance (Vd = 4.5V, Ic = 79mA, T = 25°C)

Freq	MHz	70	140	250	500	800
S21	dB	15.1	15.1	15.0	14.9	14.9
S11	dB	-18.7	-20.7	-22.0	-23.8	-26.1
S22	dB	-11.8	-14.5	-15.4	-14.0	-10.8
P1	dBm	18.6	19.3	19.4	19.3	19.4
OIP3	dBm	42.4	42.0	38.0	38.0	36.0
NF	dB	4.2	4.3	4.3	4.4	4.5

Typical Performance (Vd = 4V, Ic = 60mA, T = 25°C)

Freq	MHz	70	140	250	500	800
S21	dB	15.0	15.1	15.0	14.8	14.6
S11	dB	-19.4	-21.8	-23.4	-25.5	-28.0
S22	dB	-11.7	-14.2	-15.1	-13.7	-10.6
P1	dBm	16.4	16.9	17.0	16.9	16.7
OIP3	dBm	37.5	35.5	36.5	34.5	32.2
NF	dB	4.2	4.3	4.3	4.4	4.5

Typical Performance (Vd = 3.5V, Ic = 40mA, T = 25°C)

Freq	MHz	70	140	250	500	800
S21	dB	14.8	14.9	14.8	14.6	14.4
S11	dB	-20.7	-24.4	-26.9	-30	-32.1
S22	dB	-11.4	-13.6	-14.4	-13.1	-10.2
P1	dBm	13.4	14.1	14.2	13.6	13.3
OIP3	dBm	34	31.5	30.5	29.5	28.6
NF	dB	4.2	4.3	4.3	4.4	4.5

V-I Characteristics

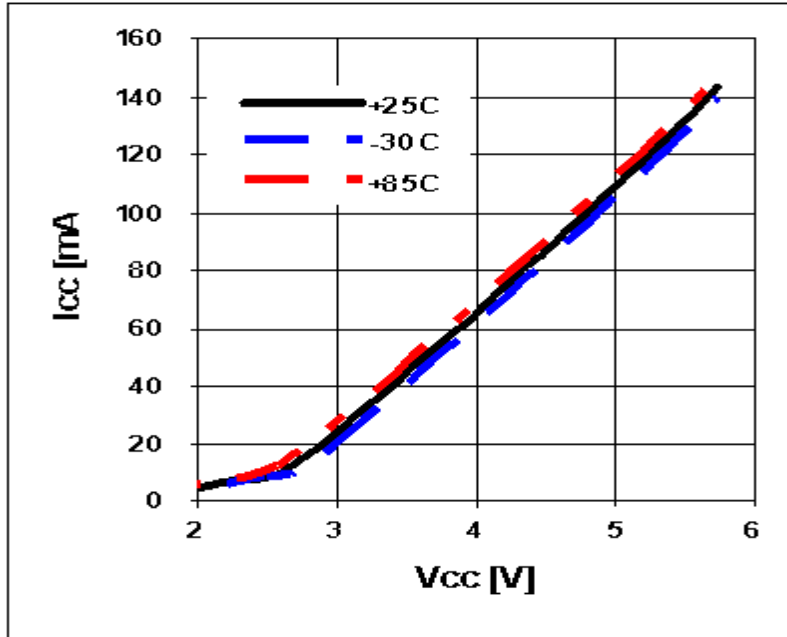

BeRex SOT89 Evaluation Board

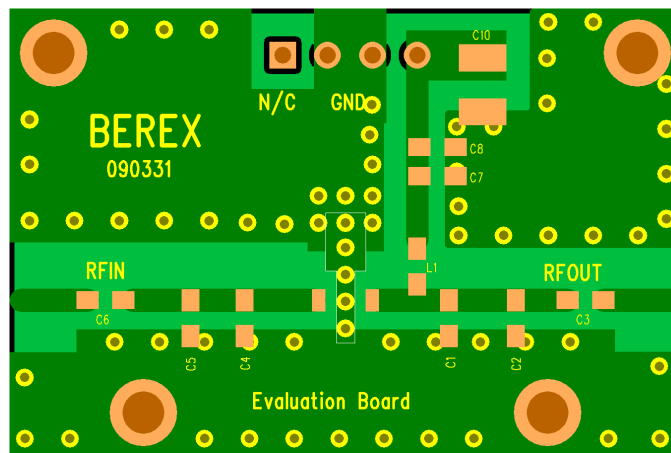

*Dielectric constant_ 4.2 *RF pattern width 52mil *31mil thick FR4 PCB

Typical Device Data

S-parameters (Vc=5V, Ic=105mA, T=25°C)

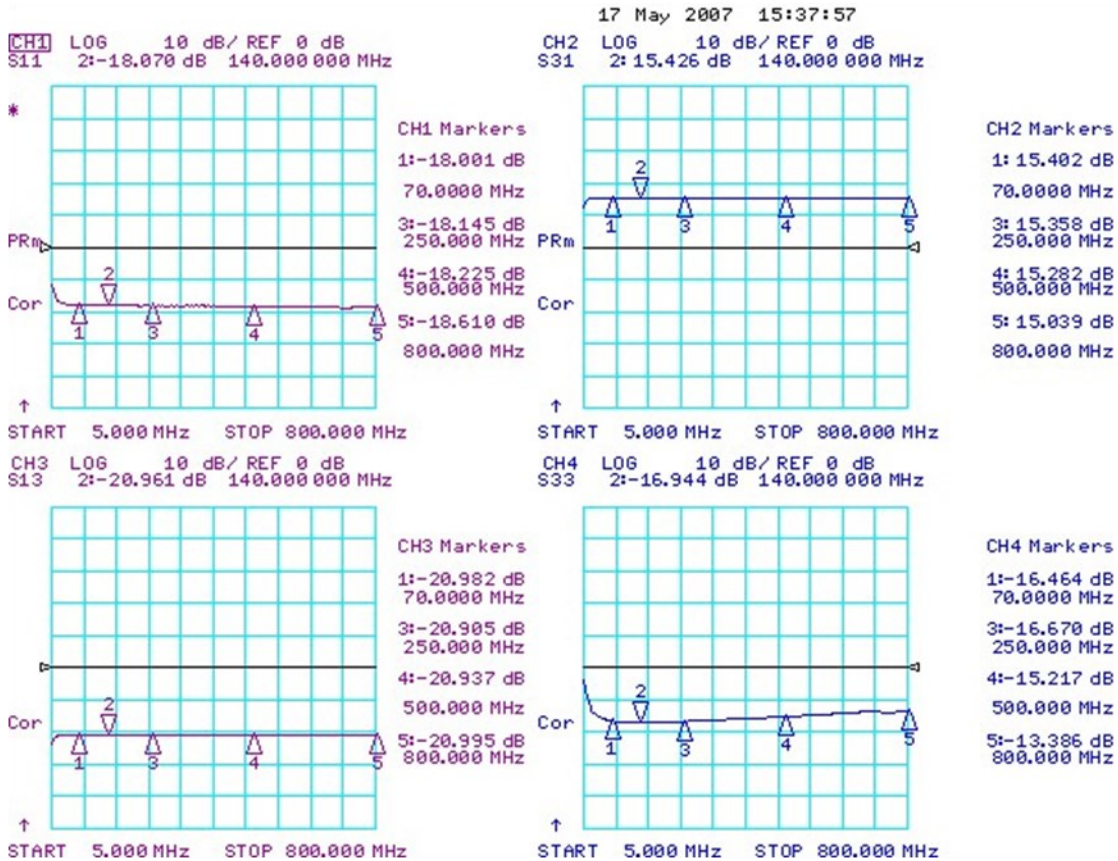

S-Parameter

(Vdevice = 5.0V, Icc = 105mA, T = 25 °C, calibrated to device leads)

Freq [MHz]	S11 [Mag]	S11 [Ang]	S21 [Mag]	S21 [Ang]	S12 [Mag]	S12 [Ang]	S22 [Mag]	S22 [Ang]
100	0.617	175.8	6.221	176.0	0.086	0.1	0.136	-11.0
500	0.610	158.6	5.549	161.5	0.094	-2.4	0.152	-58.7
1000	0.585	139.9	5.456	147.9	0.086	-4.0	0.194	-101.8
1500	0.567	121.9	5.193	134.2	0.093	-1.6	0.252	-138.3
2000	0.477	103.1	5.197	121.3	0.089	-10.2	0.294	-168.7
2500	0.450	87.8	5.296	111.9	0.089	-5.6	0.354	163.7
3000	0.408	69.5	6.415	94.6	0.094	-11.4	0.429	134.2
3500	0.368	59.9	6.356	71.1	0.091	-11.4	0.495	112.2
4000	0.381	44.8	6.220	50.3	0.101	-17.7	0.554	82.2

Typical Performance
 (Vd = 5V, Ic = 105mA, T = 25°C)

OIP3

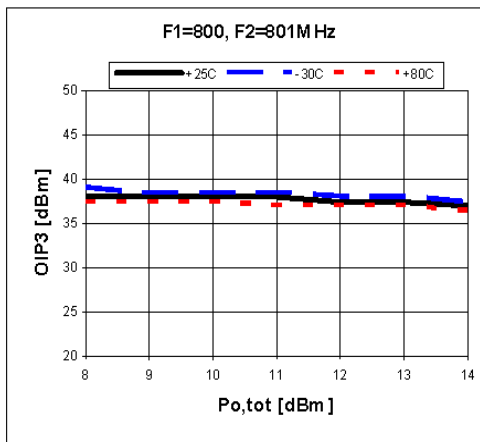
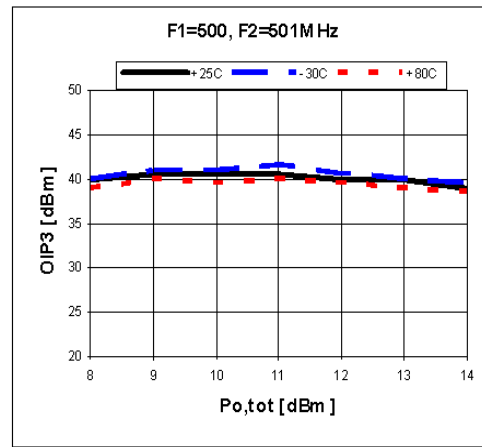
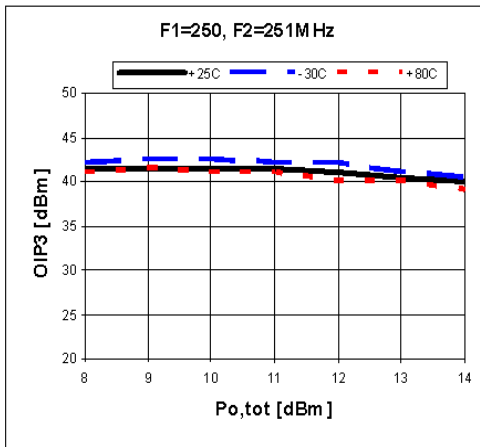
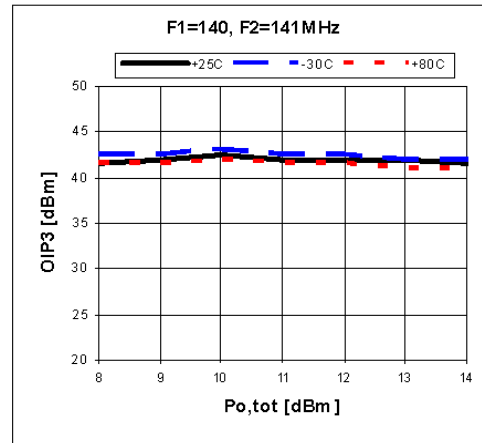
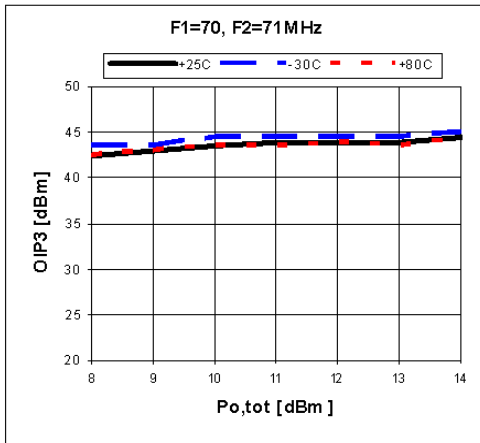

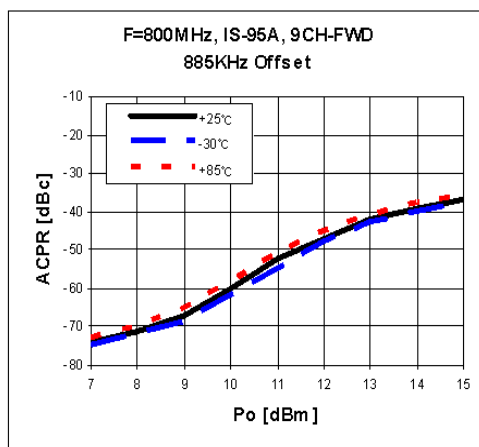
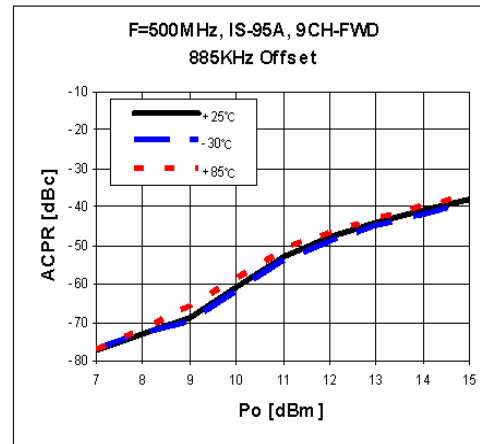
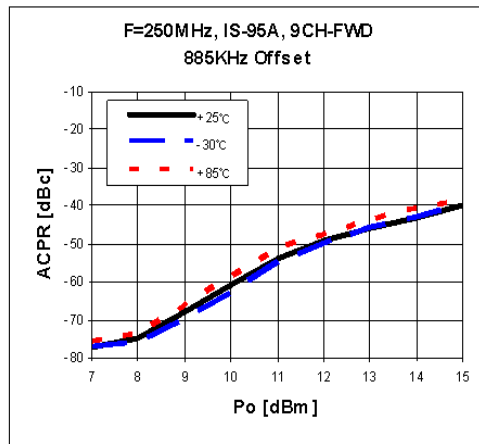
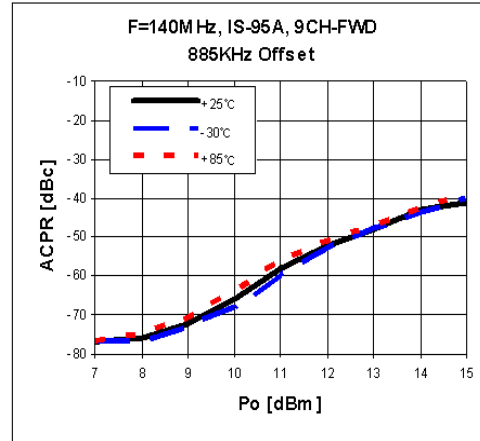
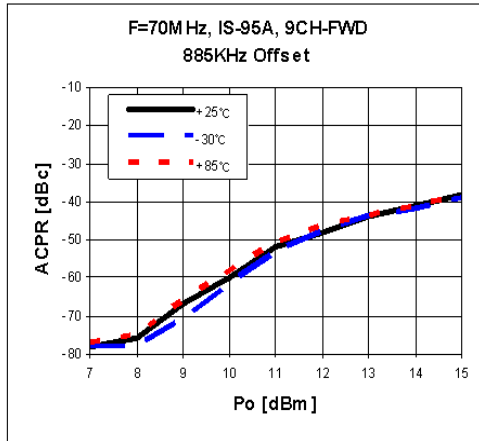
ACPR

ACLR

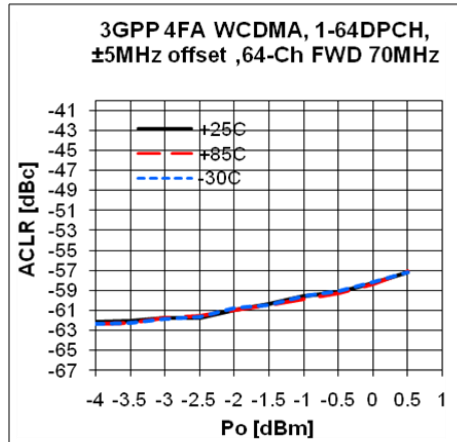

S-Parameters(S11/S22)

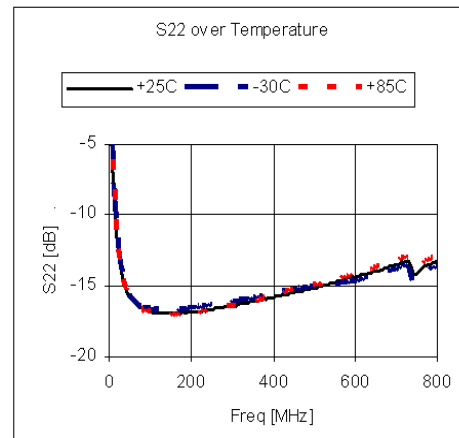
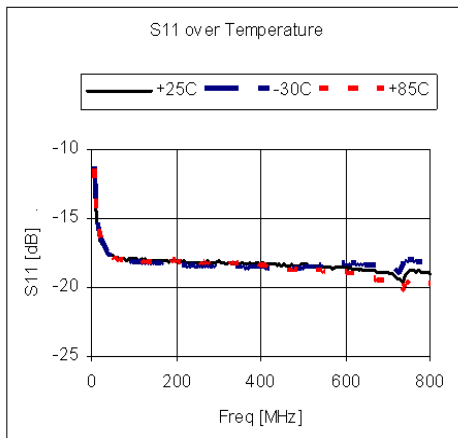

Gain Flatness

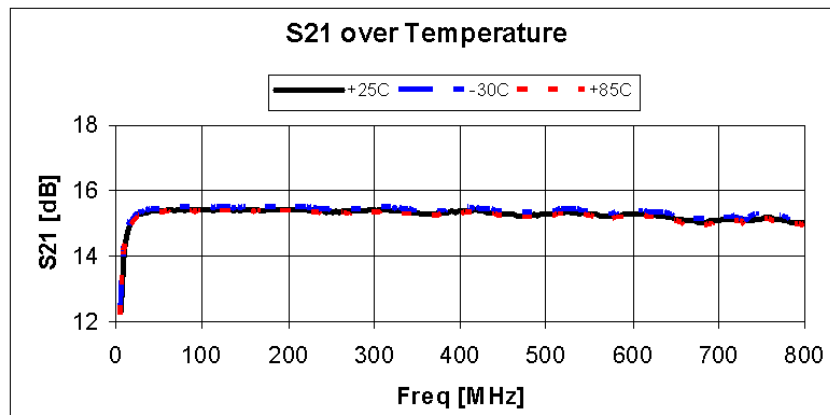

Package Outline Dimension

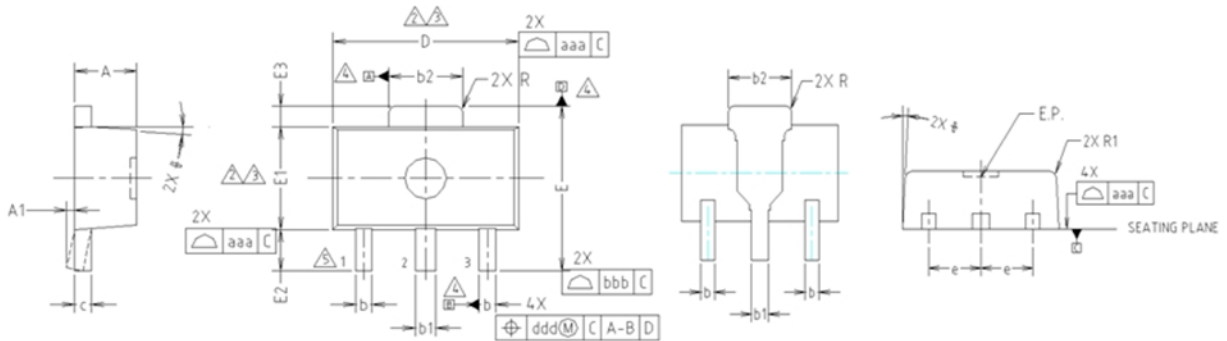

- NOTE:**
 1. DIMENSIONS IN MILLIMETERS.
- ⚠ DIMENSION D DOES NOT INCLUDE MOLD FLASH, PROTRUSIONS OR GATE BURRS. MOLD FLASH, PROTRUSIONS OR GATE BURRS SHALL NOT EXCEED 0.5mm PER END. DIMENSION E1 DOES NOT INCLUDE INTERLEAD FLASH OR PROTRUSION. INTERLEAD FLASH OR PROTRUSION SHALL NOT EXCEED 0.5mm PER SIDE.
 - ⚠ DIMENSIONS D AND E1 ARE DETERMINED AT THE OUTMOST EXTREMES OF THE PLASTIC BODY EXCLUSIVE OF MOLD FLASH, TIE BAR BURRS, GATE BURRS AND INTERLEAD FLASH, BUT INCLUDING ANY MISMATCH BETWEEN THE TOP AND BOTTOM OF THE PLASTIC BODY.
 - ⚠ DATUMS A, B AND D TO BE DETERMINED 0.18mm FROM THE LEAD TIP.
 - ⚠ TERMINAL NUMBERS ARE SHOWN FOR REFERENCE ONLY.

SYMBOL	MILLIMETERS			NOTE
	MINIMUM	NOMINAL	MAXIMUM	
A	1.40	1.50	1.60	
A1	0.00	—	0.10	
b	0.38	0.42	0.48	
b1	0.48	0.52	0.58	
b2	1.79	1.82	1.87	
c	0.40	0.42	0.46	
D	4.40	4.50	4.70	2,3
E	3.70	4.00	4.30	
E1	2.40	2.50	2.70	2,3
E2	0.80	1.00	1.20	
E3	0.40	0.50	0.60	
e	1.50 TYP.			
φ	4° TYP.			
R	0.15 TYP.			
R1	—	—	0.20	
SYMBOL	TOLERANCES OF FORM AND POSITION		NOTE	
aaa	0.15			
bbb	0.20			
ccc	0.10			
ddd	0.10			

Suggested PCB Land Pattern and PAD Layout

PCB Land Pattern

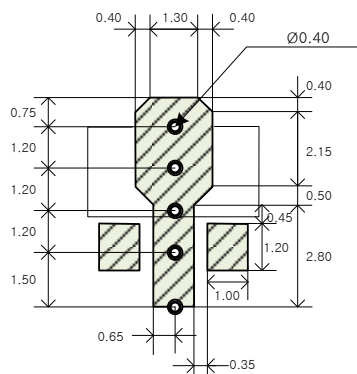

Note : All dimension _ millimeters

PCB lay out _ on BeRex website

PCB Mounting

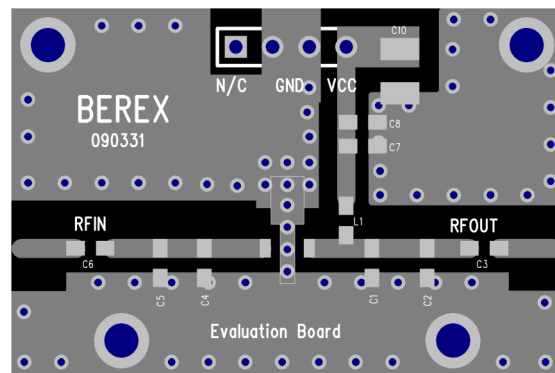

Package Marking

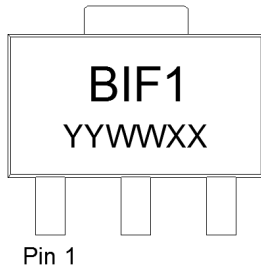

YY = Year, WW = Working Week,
XX = Wafer No.

Tape & Reel

SOT89

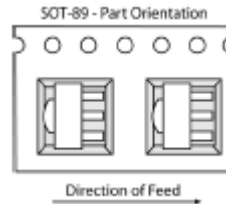

Packaging information:

Tape Width (mm): 12
Reel Size (inches): 7
Device Cavity Pitch (mm): 8
Devices Per Reel: 1000

Lead plating finish

100% Tin Matte finish

(All BeRex products undergoes a 1 hour, 150 degree C, Anneal bake to eliminate thin whisker growth concerns.)

MSL / ESD Rating

ESD Rating:	Class 1C
Value:	Passes <2000V
Test:	Human Body Model (HBM)
Standard:	JEDEC Standard JESD22-A114
MSL Rating:	Level 1 at +260°C convection reflow
Standard:	JEDEC Standard J-STD-020



Proper ESD procedures should be followed when handling this device.

RoHS Compliance

This part is compliant with Restrictions on the Use of Certain Hazardous Substances in Electrical and Electronic Equipment (RoHS) Directive 2011/65/EU as amended by Directive 2015/863/EU.

This product also is compliant with a concentration of the Substances of Very High Concern (SVHC) candidate list which are contained in a quantity of less than 0.1%(w/w) in each components of a product and/or its packaging placed on the European Community market by the BeRex and Suppliers.

NATO CAGE code:

2	N	9	6	F
---	---	---	---	---