

Revision Level			Revision Record	Changed	Date	Approved	Date
Drawing	State	Part					
01.2	DESIGN RELEASE		SEE ECN# 014407	FDS	4/20/18	EJH	4/20/18

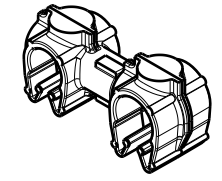

ISOMETRIC VIEW

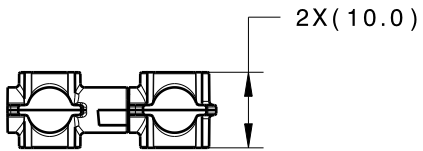
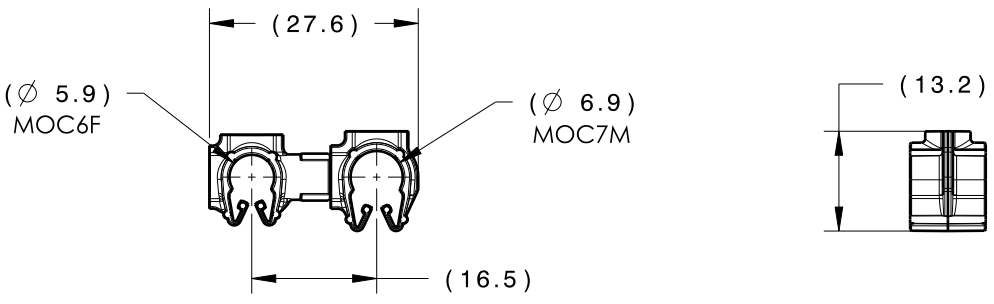

CLIPS ROTATE 360 DEGREES

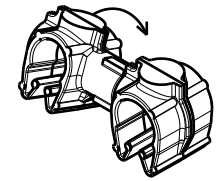

ISOMETRIC VIEW ROTATED

TYPE	MOC6F	MOC7M
HARNESS	5.5MM-6.5MM	6.5MM-7.5MM
HOSE	5.5MM-6.5MM	6.0MM-7.5MM
HARD PIPE/TUBE	6.0MM-6.8MM	7.0MM-8.0MM

\*RECOMMENDED SIZES MAY DIFFER DEPENDING ON THE APPLICATION, PRODUCT REQUIREMENTS AND MATERIALS USED

GLOBAL PART DESCRIPTION 	MOC6F			MOC7M		
	DRAWING	MATERIAL	COLOR	DRAWING	MATERIAL	COLOR
MOC6FMOC7M-PA66HIRHS-BK	16-0314-000-CSU	PA66HIRHS	BLACK	16-0315-000-CSU	PA66HIRHS	BLACK

Material SEE CHART COLOR: SEE CHART	Units <b>millimeters</b>	The copyright of this drawing is reserved by HellermannTyton. It is issued on condition that it is not reproduced, copied or disclosed to a third party, either wholly or in part, without the consent of HellermannTyton.	Drawn	TAT	2/21/17	Article/Type-No	MOC6FMOC7M	Scale	1:1
	Tolerance defined on each dimension		Approved	EJH	2/28/17	Title	 6MM MOC COUPLED TO A 7MM MOC	Project Number	16-0326
			<b>HellermannTyton</b>			North America Email: corp@htamericas.com Web: www.hellermann.tyton.com		Drawing-No	PRODUCTION : Phase
<b>16-0326-127-CSU</b> 								Sheet	1/1