

8

7

6

5

4

3

2

1

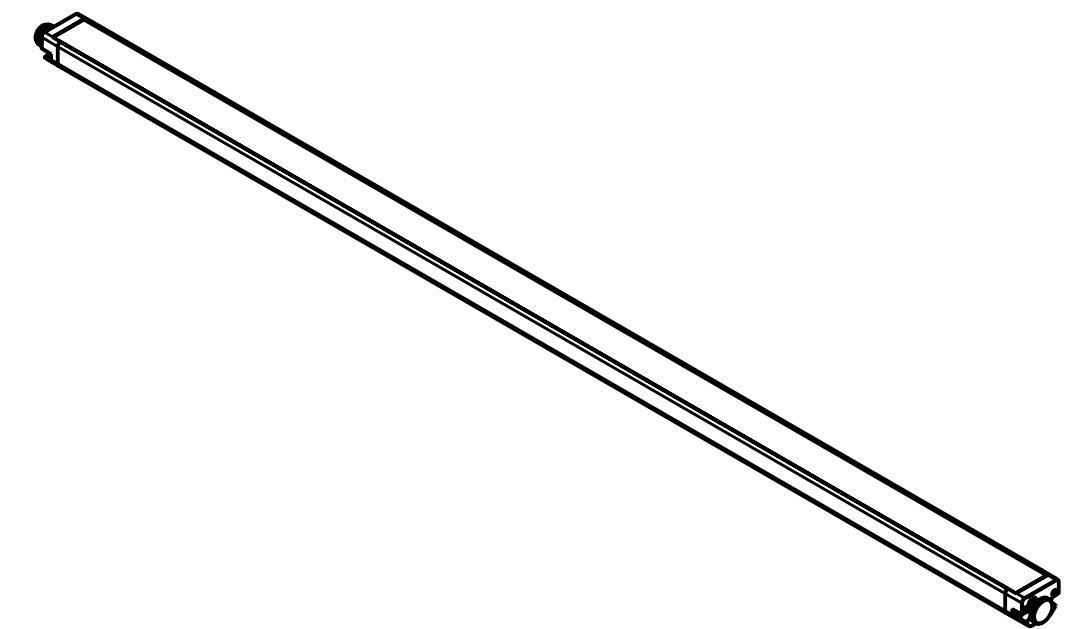
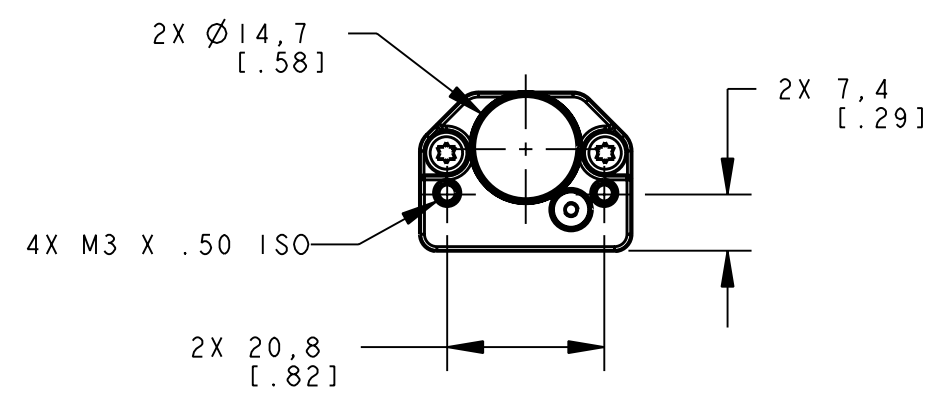

ISOMETRIC VIEW
SCALE 1:4

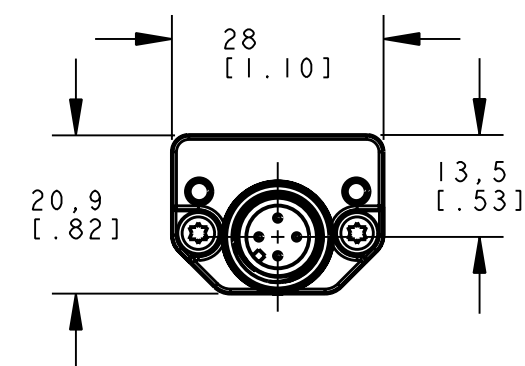
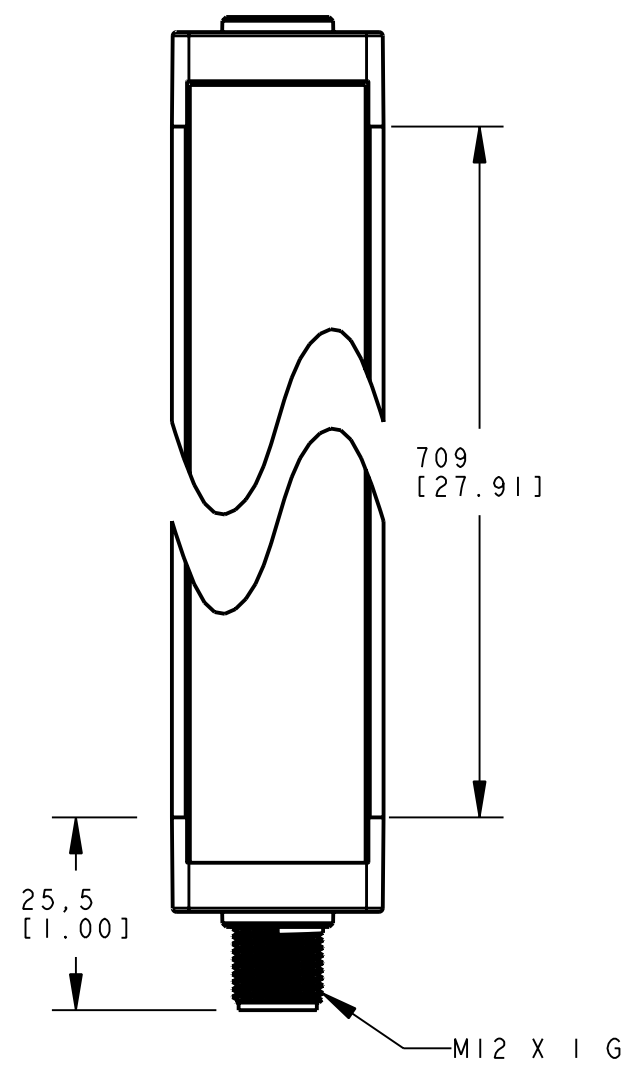
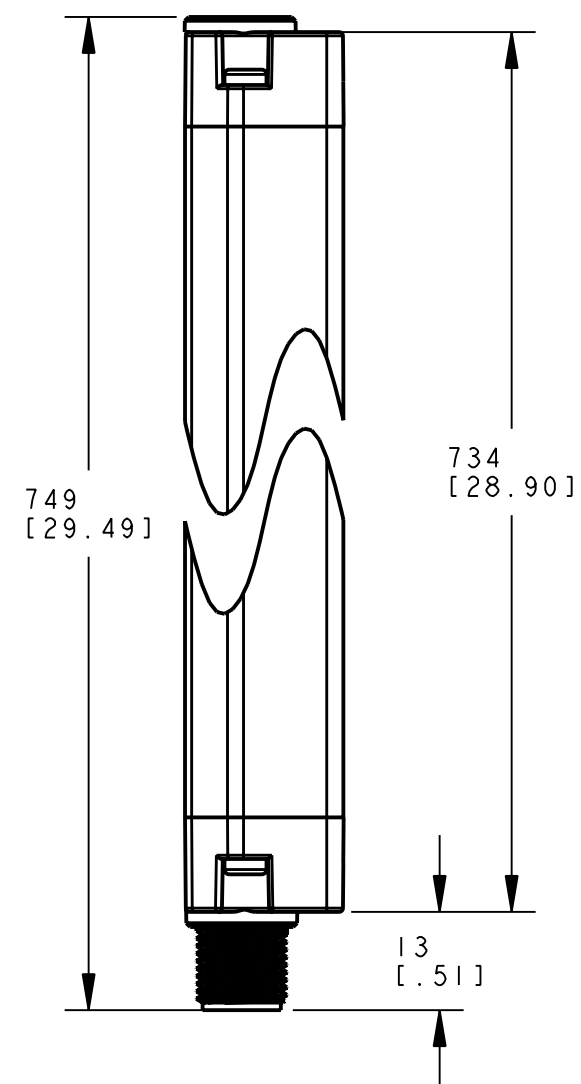

NOTES:
1. ALL DIMENSIONS ARE MILLIMETERS [INCHES] UNLESS OTHERWISE NOTED.

This drawing is the property of BANNER ENGINEERING CORP. and is proprietary in general and in detail. Its contents shall not be revealed to outside parties without written consent of BANNER.



BANNER ENGINEERING CORP.
P.O. BOX 9414
MINNEAPOLIS, MN 55440

THIRD ANGLE PROJECTION

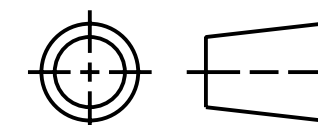

TITLE		WLS28X710SO WEB CAD DRAWINGS 2D/3D	
SIZE C	DRAWING NO. 157901	REV. A	
SCALE 1:1		SHEET 1 OF 1	

8

7

6

5

4

3

2

1

PRO/E