

## TINA2-M

~30° medium beam optimized for Nichia NCSxx19. Assembly with holder, installation tape and location pins.

### SPECIFICATION:

Dimensions	Ø 16.1 mm
Height	9.3 mm
Fastening	tape, pin
ROHS compliant	yes ⓘ



### MATERIALS:

Component	Type	Material	Colour	Finish
TINA2-XP-M	Single lens	PMMA	clear	
TINA2-HLD-NCS19-BLK	Holder	PC	black	
TINA-TAPE3	Tape	Acrylic foam	black	

### ORDERING INFORMATION:

Component		Qty in box	MOQ	MPQ	Box weight (kg)
CA11021_TINA2-M	Single lens	4140	0	230	0.0
» Box size: 451 x 241 x 298 mm					

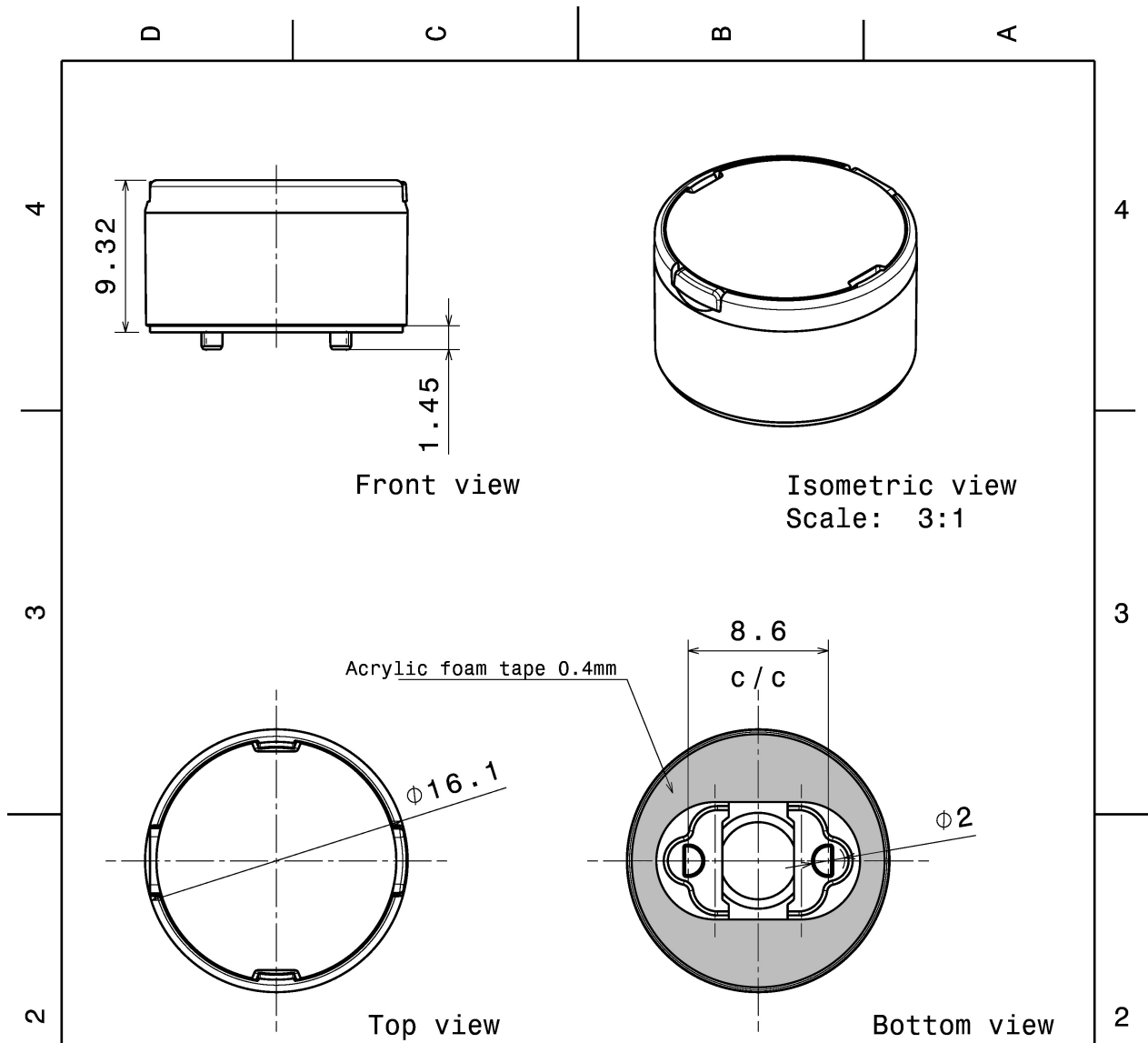

INDEX	PART NO	DESCRIPTION	MATERIAL	COLOUR
1	-	TINA2-lens	PMMA	clear
2	C11010	TINA2-HLD-NCS19-BLK	PC	black

Tolerances if not otherwise shown  
According to DIN ISO 2768-1  
Linear measures:  
Up to 30mm class M, otherwise class C.  
According to DIN ISO 2768-2  
Form and position: class L

**LEDiL** Ledil Oy  
Salorankatu 10  
FIN 24240 SALO  
Finland

THIRD ANGLE PROJECTION:

DRAWING TITLE  
**TINA2-NCS19 series**

This drawing is the property of LEDiL Oy. It may not be reproduced, copied or communicated without a written agreement with LEDiL Oy.

SIZE	PART NUMBER
A4	-

SCALE	3:1	WEIGHT	1 g	SHEET	1/1
-------	-----	--------	-----	-------	-----

See also our general installation guide: [www.ledil.com/installation\\_guide](http://www.ledil.com/installation_guide)

### OPTICAL RESULTS (MEASURED):



LED NCSxx19A  
FWHM / FWTM 25.0° / 51.0°  
Efficiency 89 %  
Peak intensity 2.8 cd/lm  
LEDs/each optic 1  
Light colour White  
Required components:

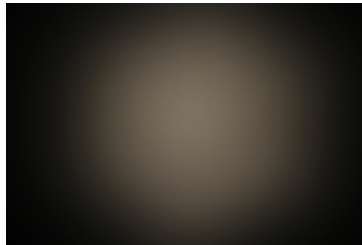

### SAMSUNG

LED LH181A  
FWHM / FWTM 28.0° / 54.0°  
Efficiency 80 %  
Peak intensity 2.6 cd/lm  
LEDs/each optic 1  
Light colour White  
Required components:

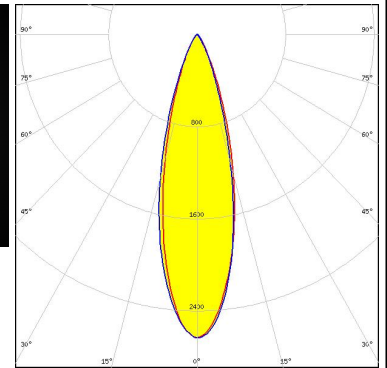
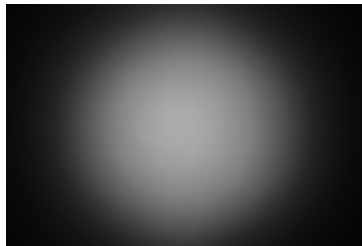

### SAMSUNG

LED LH181B  
FWHM / FWTM 28.0° / 52.0°  
Efficiency 86 %  
Peak intensity 3 cd/lm  
LEDs/each optic 1  
Light colour White  
Required components:

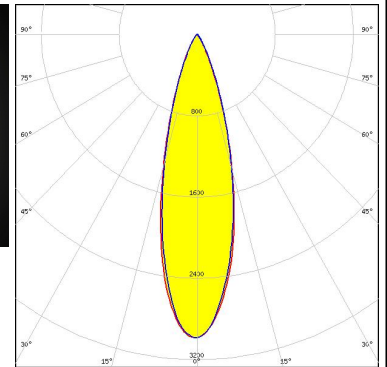
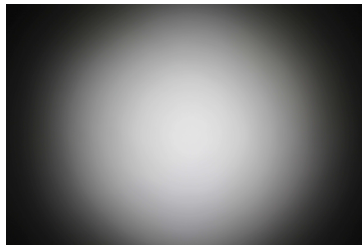

### OPTICAL RESULTS (SIMULATED):



LED XP-G3  
 FWHM / FWTM 32.0° / 59.0°  
 Efficiency 84 %  
 Peak intensity 2.3 cd/lm  
 LEDs/each optic 1  
 Light colour White  
 Required components:

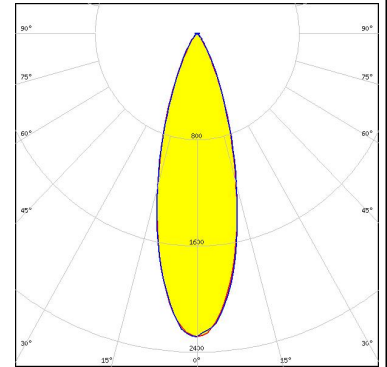

LED LUXEON HL1Z  
 FWHM / FWTM 28.0 + 29.0° / 48.0 + 52.0°  
 Efficiency 90 %  
 Peak intensity 3.3 cd/lm  
 LEDs/each optic 1  
 Light colour White  
 Required components:

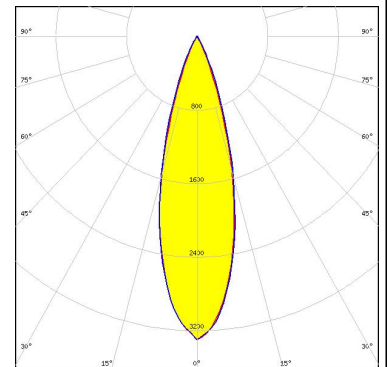

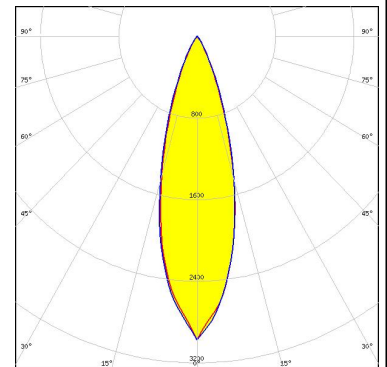

LED LUXEON SunPlus 20 Line (150 deg)  
 FWHM / FWTM 30.0° / 54.0°  
 Efficiency 88 %  
 Peak intensity 3 cd/lm  
 LEDs/each optic 1  
 Light colour White  
 Required components:

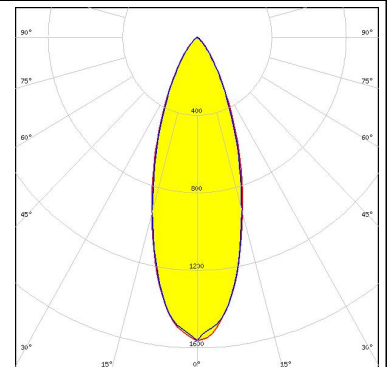

LED NCSxE17A  
 FWHM / FWTM 35.0° / 70.0°  
 Efficiency 79 %  
 Peak intensity 1.6 cd/lm  
 LEDs/each optic 4  
 Light colour White  
 Required components:

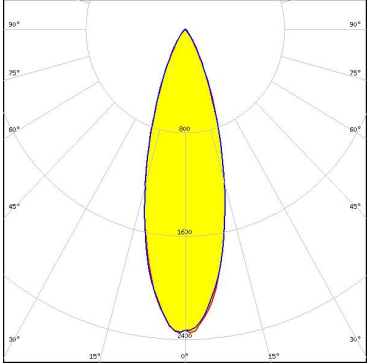

### OPTICAL RESULTS (SIMULATED):

		
LED	NVSxE21A	
FWHM / FWTM	28.0° / 53.0°	
Efficiency	88 %	
Peak intensity	3.1 cd/lm	
LEDs/each optic	1	
Light colour	White	
Required components:		
		
LED	NVSxx19A	
FWHM / FWTM	32.0° / 59.0°	
Efficiency	84 %	
Peak intensity	2.4 cd/lm	
LEDs/each optic	1	
Light colour	White	
Required components:		

### GENERAL INFORMATION:

NOTE: The typical beam angle will be changed by different color, chip size and chip position tolerance. The typical total beam angle is the full angle measured where the luminous intensity is half of the peak value.

### MATERIALS:

As part of our continuous research and improvement processes, and to ensure the best possible quality and availability of our products, LEDiL reserves the right to change material grades without notice.

### PRODUCT DATA USER AGREEMENT AND DISCLAIMER:

The measured data in the provided downloadable LEDiL Product Datasheets and Mechanical 2D-Drawings is rounded and provided as reference for planning. LEDiL Oy's optical specifications have been verified by conducting performance testing of the products in accordance with the company's quality system. The reported data are averaged results of multiple measurements with typical variation. LEDiL Oy reserves the right to without prior notification make changes and improvements to its products.

LEDiL Oy assumes neither warranty, nor guarantee nor any other liability of any kind for the contents and correctness of the provided data. The provided data has been generated with highest diligence but the provided data may in reality not represent the complete possible variation range of all intrinsic parameters. Therefore, in certain cases a deviation from the provided data could occur.

LEDiL Oy reserves the right to undertake technical changes of its products without further notification which could lead to changes in the provided data. LEDiL Oy assumes no liability of any kind for the possible deviation from any provided data or any other damage resulting from the usage of the provided data.

The user agrees to this disclaimer and user agreement with the download or usage of the provided files.

#### LEDiL Oy

Joensuunkatu 13  
FI-24240 SALO  
Finland

#### LEDiL Inc.

228 West Page Street  
Suite D  
Sycamore IL 60178  
USA

#### Ledil Optics Technology (Shenzhen) Co., Ltd.

# 405 , Block B  
Casic Motor Building  
Shenzhen 518057  
P.R.CHINA

#### Local sales and technical support

[www.ledil.com/  
where\\_to\\_buy](http://www.ledil.com/where_to_buy)

#### Shipping locations

Salo, Finland  
Hong Kong, China

#### Distribution Partners

[www.ledil.com/  
where\\_to\\_buy](http://www.ledil.com/where_to_buy)