

Main

Accessory / separate part category	Cabling accessory
Accessory / Separate Part Type	Jumper cable

Complementary

Jumper cable end 1	M12 male 5 pins straight screw-on
Jumper cable end 2	M12 female 5 pins elbowed screw-on
Cable composition	4 x 0.34 mm ² + 1 x 0.5 mm ²
Cable length	6.56 ft (2 m)
Wire insulation material	PUR
Cable outer diameter	0.23 in (5.9 mm)
[Ue] rated operational voltage	30 V AC 36 V DC
Line Rated Current	4 A
Insulation resistance	>= 1000 MOhm
Maximum resistance across terminals	5000 mOhm
Net Weight	0.29 lb(US) (0.13 kg)

Environment

IP Degree of Protection	IP65 IP67 IP69K
Product Certifications	cULus
Ambient air temperature for operation	-31...194 °F (-35...90 °C) static 23...194 °F (-5...90 °C) flexing
Ambient Air Temperature for Storage	-31...212 °F (-35...100 °C)

Ordering and shipping details

Category	22483-MACHINE CABLES
Discount Schedule	DS3
GTIN	3389110762464
Nbr. of units in pkg.	1
Package weight(Lbs)	3.53 oz (100.0 g)
Returnability	No
Country of origin	CZ

Packing Units

Unit Type of Package 1	PCE
Package 1 Height	0.79 in (2 cm)
Package 1 width	9.45 in (24 cm)
Package 1 Length	9.45 in (24 cm)
Unit Type of Package 2	S02
Number of Units in Package 2	40
Package 2 Weight	9.63 lb(US) (4.366 kg)
Package 2 Height	5.91 in (15 cm)
Package 2 width	11.81 in (30 cm)
Package 2 Length	15.75 in (40 cm)

Offer Sustainability

Sustainable offer status	Green Premium product
California proposition 65	WARNING: This product can expose you to chemicals including: Diisononyl phthalate (DINP), which is known to the State of California to cause cancer, and Di-isodecyl phthalate (DIDP), which is known to the State of California to cause birth defects or other reproductive harm. For more information go to www.P65Warnings.ca.gov
REACH Regulation	REACH Declaration
EU RoHS Directive	Pro-active compliance (Product out of EU RoHS legal scope) EU RoHS Declaration
Mercury free	Yes
RoHS exemption information	Yes
Environmental Disclosure	Product Environmental Profile
Circularity Profile	End Of Life Information

Contractual warranty

Warranty	18 months
----------	-----------

Dimensions

mm
in.

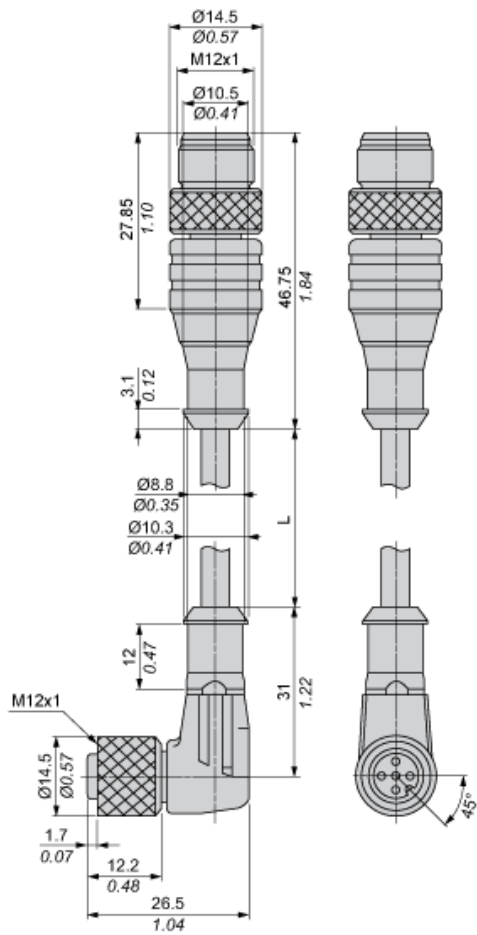

L : Length of cable

Connections and Schemes

