

10A, 600V - 1000V Standard Bridge Rectifier

FEATURES

- AEC-Q101 qualified available
- Thin Single-in-line low profile package ideal for compact required circuit
- Glass passivated chip junction
- High surge current capability
- UL Recognized File # E-326243
- RoHS Compliant
- Halogen-free according to IEC 61249-2-21

APPLICATIONS

- Switching mode power supply
- Adapters
- Lighting application

MECHANICAL DATA

- Case: KBJL
- Molding compound meets UL 94V-0 flammability rating
- Terminal: Matte tin plated leads, solderable per J-STD-002
- Meet JESD 201 class 2 whisker test
- Mounting torque: 0.56 N·m maximum
- Polarity: As marked
- Weight: 2.50g (approximately)

KEY PARAMETERS		
PARAMETER	VALUE	UNIT
I_F	10	A
V_{RRM}	600 - 1000	V
I_{FSM}	180	A
$T_{J\ MAX}$	150	°C
Package	KBJL	
Configuration	Quad	

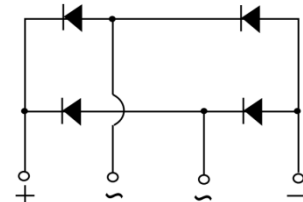
KBJL

ABSOLUTE MAXIMUM RATINGS ($T_A = 25^\circ\text{C}$ unless otherwise noted)

PARAMETER	SYMBOL	TS10KL60	TS10KL80	TS10KL100	UNIT
Marking code on the device		TS10KL60	TS10KL80	TS10KL100	
Repetitive peak reverse voltage	V_{RRM}	600	800	1000	V
Reverse voltage, total rms value	$V_{R(RMS)}$	420	560	700	V
Forward current	I_F	10			A
Surge peak forward current, 8.3ms single half sine-wave superimposed on rated load	I_{FSM}	180			A
Rating for fusing ($t < 8.3\text{ms}$)	I^2t	134.46			A^2s
Junction temperature	T_J	- 55 to +150			°C
Storage temperature	T_{STG}	- 55 to +150			°C

THERMAL PERFORMANCE			
PARAMETER	SYMBOL	TYP	UNIT
Junction-to-case thermal resistance	$R_{\theta JC}$	1.5	°C/W

Thermal Performance Note: Units mounted on 4" x 6" x 0.25" Al-plate

ELECTRICAL SPECIFICATIONS ($T_A = 25^\circ\text{C}$ unless otherwise noted)					
PARAMETER	CONDITIONS	SYMBOL	TYP	MAX	UNIT
Forward voltage per diode ⁽¹⁾	$I_F = 5\text{A}, T_J = 25^\circ\text{C}$	V_F	-	1	V
Reverse current @ rated V_R per diode ⁽²⁾	$T_J = 25^\circ\text{C}$	I_R	-	5	μA
	$T_J = 125^\circ\text{C}$		-	150	μA

Notes:

1. Pulse test with $PW = 0.3\text{ms}$
2. Pulse test with $PW = 30\text{ms}$

ORDERING INFORMATION		
ORDERING CODE ⁽¹⁾⁽²⁾	PACKAGE	PACKING
TS10KLx	KBJL	20 / Tube
TS10KLxH	KBJL	20 / Tube

Notes:

1. "x" defines voltage from 600V(TS10KL60) to 1000V(TS10KL100)
2. "H" means AEC-Q101 qualified

CHARACTERISTICS CURVES

($T_A = 25^\circ\text{C}$ unless otherwise noted)

Fig.1 Forward Current Derating Curve

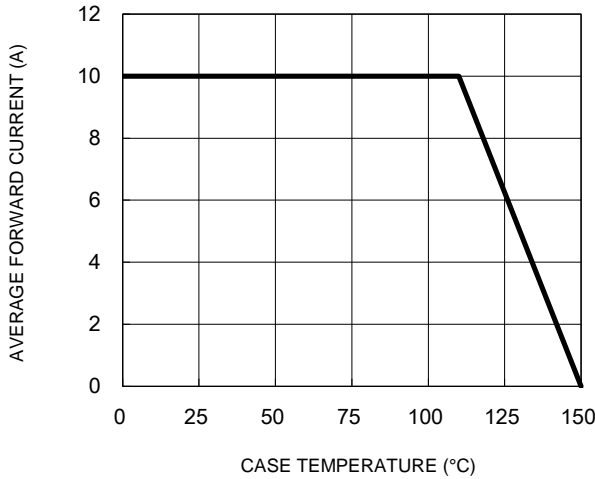

Fig.2 Typical Junction Capacitance

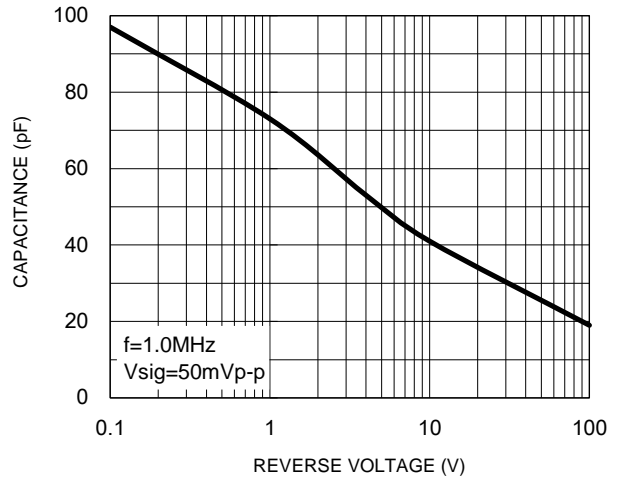

Fig.3 Typical Reverse Characteristics

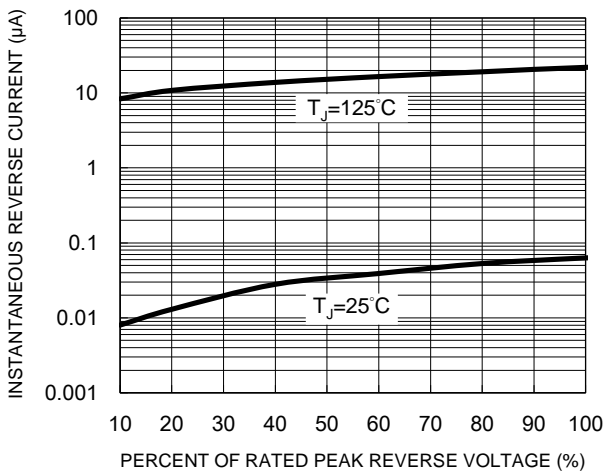

Fig.4 Typical Forward Characteristics

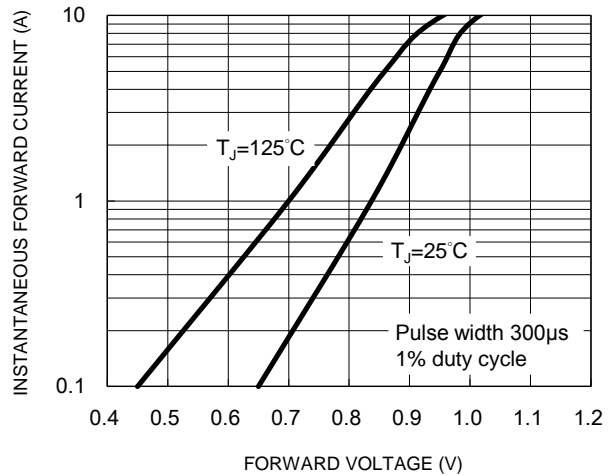
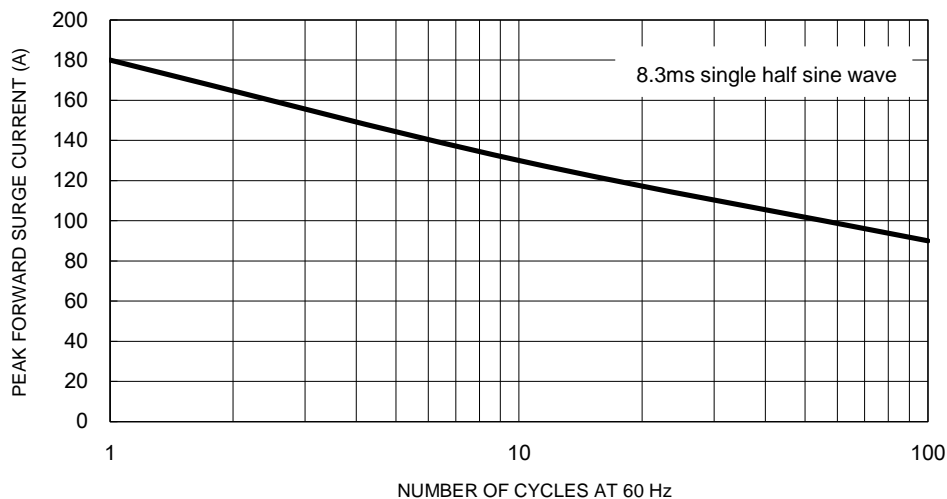
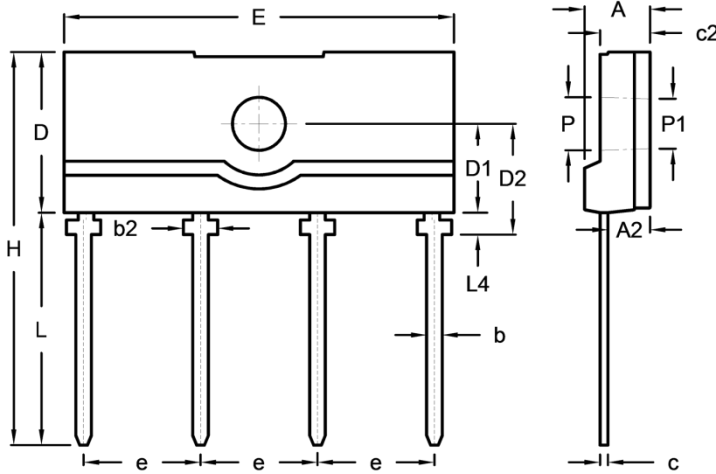

Fig.5 Maximum Non-Repetitive Forward Surge Current



PACKAGE OUTLINE DIMENSIONS

KBJL



DIM.	Unit (mm)		Unit (inch)	
	Min.	Max.	Min.	Max.
A	4.00	4.40	0.157	0.173
A2	2.50	2.90	0.098	0.114
b	0.90	1.10	0.035	0.043
b2	2.10	2.30	0.083	0.091
c	0.30	0.70	0.012	0.028
c2	3.00	3.40	0.118	0.134
D	10.00	10.60	0.394	0.417
D1	5.50	5.90	0.217	0.232
D2	6.90	7.30	0.272	0.287
E	24.70	25.30	0.972	0.996
e	7.30	7.70	0.287	0.303
H	24.90	25.50	0.980	1.004
L	14.40	15.40	0.567	0.606
L4	1.20	1.60	0.047	0.063
P	3.30	3.50	0.130	0.138
P1	3.10	3.30	0.122	0.130

MARKING DIAGRAM



- P/N = Marking Code
- G = Green Compound
- YWW = Date Code
- F = Factory Code

Notice

Specifications of the products displayed herein are subject to change without notice. TSC or anyone on its behalf, assumes no responsibility or liability for any errors or inaccuracies.

Purchasers are solely responsible for the choice, selection, and use of TSC products and TSC assumes no liability for application assistance or the design of Purchasers' products.

Information contained herein is intended to provide a product description only. No license, express or implied, to any intellectual property rights is granted by this document. Except as provided in TSC's terms and conditions of sale for such products, TSC assumes no liability whatsoever, and disclaims any express or implied warranty, relating to sale and/or use of TSC products including liability or warranties relating to fitness for a particular purpose, merchantability, or infringement of any patent, copyright, or other intellectual property right.

The products shown herein are not designed for use in medical, life-saving, or life-sustaining applications. Customers using or selling these products for use in such applications do so at their own risk and agree to fully indemnify TSC for any damages resulting from such improper use or sale.