

Data sheet | Item number: 757-185

M12 sensor/actuator box; 8-way; 5-pole; M23 connector

www.wago.com/757-185

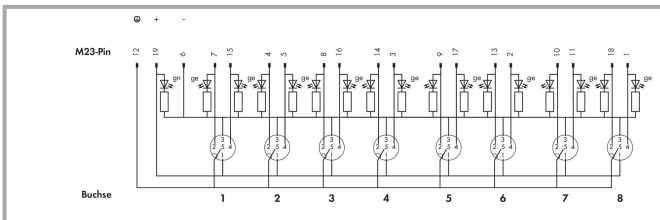
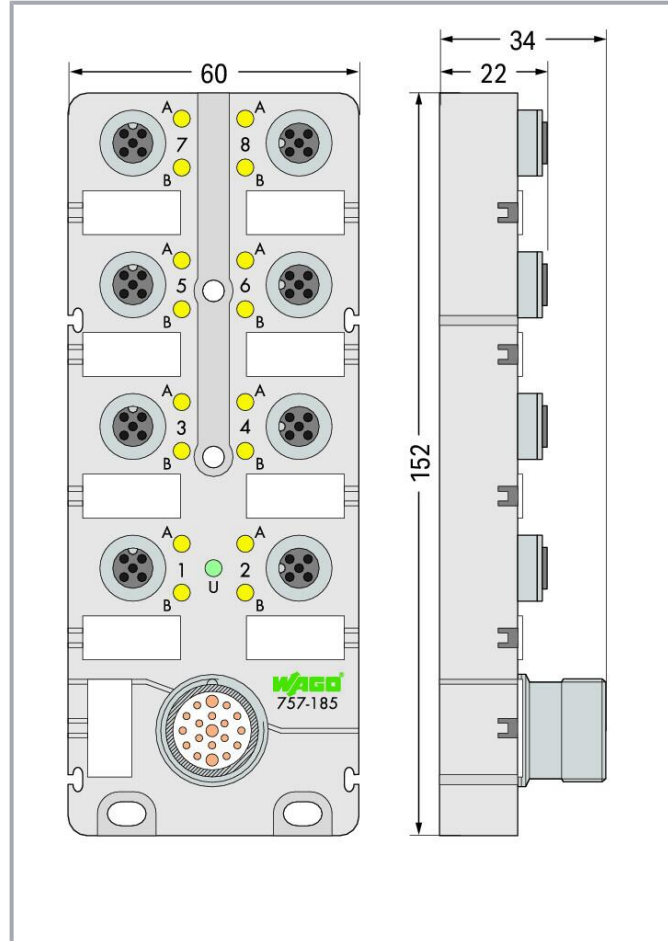

Subject to changes. Please also observe the further product documentation!

WAGO GmbH & Co. KG
Hansastr. 27
32423 Minden
Phone: +49571 887-0 | Fax: +49571 887-169
Email: info.de@wago.com | Web: www.wago.com

Do you have any questions about our products?
We are always happy to take your call at +49 (571) 887-44222.

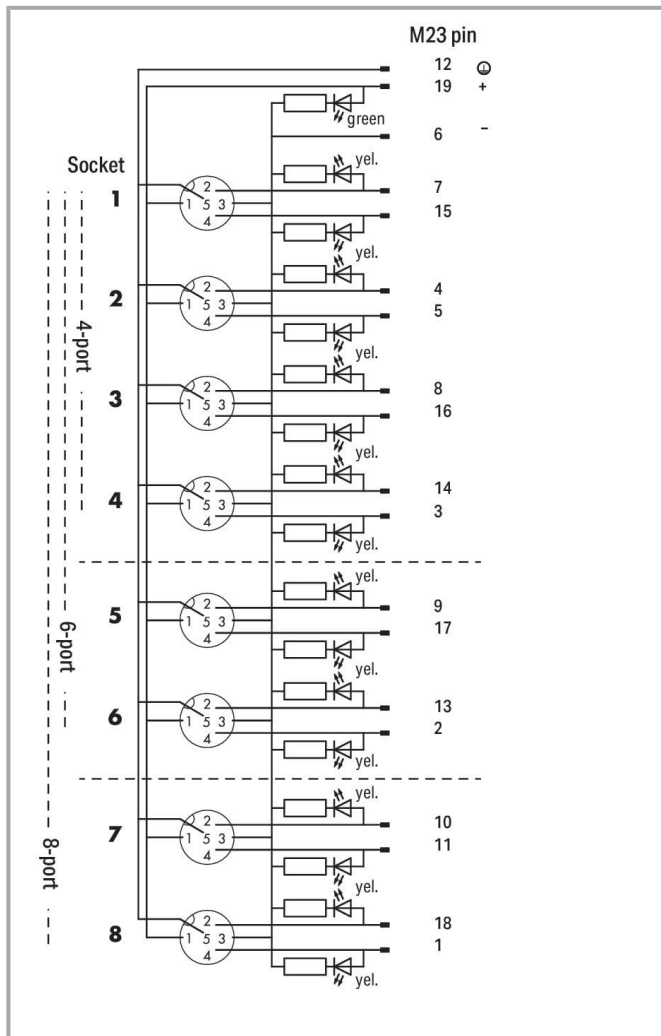

Item description

- M12 sensor/actuator box, 8-way
- 5-pole (2 signals per contact)
- M23 connector (19-pole)
- Green LED operating indicator
- Yellow LED status indicator
- incl. markers (10 pcs)
- incl. M12 protective caps (2 pcs)

Subject to changes. Please also observe the further product documentation!



Data

Technical data

Contact resistance (max.)	0.01 Ω
Supply voltage	10 ... 30 VDC; Rated voltage: 32 V ~ rms
Current carrying capacity (signal connections)	2 A
Current carrying capacity (supply connections)	9 A
Rated value of electrical isolation	500 V
Functionally separated potential groups	Kontakt/Kontakt
Insulation resistance	1000 M Ω
Signal characteristics	PNP
Indicators	LED (A, B) yellow: Signal status (2 x per contact); LED (U) green: Sensor/actuator box status

Connection data

Connection technology: inputs/outputs	8 x M12 socket; 5-pole; incl. ground
Connection technology: trunk cable	1 x M23 plug; 19-pole

Physical data

Width	60 mm / 2.362 inches
Height	34 mm / 1.339 inches
Depth	152 mm / 5.984 inches

Mechanical Data

Mounting type	Screw mounting
Weight	240 g

Material Data

Housing material	PA 66 (UL 94 V0); RAL 7035; silicon and halogen free
Material properties of the connections	Contact: CuSn, nickel base-coat plating and 0.8 μ m gold-plated; Threaded bush: die-cast Zn, nickel-plated; Seal: Viton; 50 mating cycles
Encapsulation	Fully encapsulated with conformal coating (UL 94 V0)

Environmental requirements

Ambient temperature (operation)	-25 ... +80 $^{\circ}$ C
---------------------------------	--------------------------

Subject to changes. Please also observe the further product documentation!

WAGO GmbH & Co. KG
 Hansastr. 27
 32423 Minden
 Phone: +49571 887-0 | Fax: +49571 887-169
 Email: info.de@wago.com | Web: www.wago.com

Do you have any questions about our products?
 We are always happy to take your call at +49 (571) 887-44222.



Protection type	IP67
Note on protection type	per EN 60529 (NEMA 6 & 6P) in fully locked position with its plugs or protective caps
Pollution degree	3 per VDE 0110
Vibration resistance	per IEC 60068-2-6
Shock resistance	per IEC 60068-2-27

Commercial data

eCl@ss 10.0	27-44-01-11
eCl@ss 9.0	27-44-01-08
ETIM 8.0	EC003558
ETIM 7.0	EC002585
PU (SPU)	1 pcs
Packaging type	box
Country of origin	DE
GTIN	4050821054344
Customs tariff number	85366990990

Environmental Product Compliance

CAS-No.	7439-92-1
REACH Candidate List Substance	Lead
RoHS Compliance Status	Compliant,With Exemption
RoHS Exemption	6(c)
SCIP notification number (Austria)	9c6afcaf-7a71-48cc-b0cc-ee1cf242a313
SCIP notification number (Belgium)	9eb131bb-74df-4725-9cef-88f7f5e6127a
SCIP notification number (Bulgaria)	83796fd7-8e46-41b5-81cf-23dbd95c6097
SCIP notification number (Czech Republic)	ed4d6d9d-6abf-4b9a-9415-54ca8bbcab97
SCIP notification number (Denmark)	e9d05182-5036-498e-9172-17a4c3c7cbd1
SCIP notification number (Finland)	6149b298-c416-4b2d-8ef5-bfa20b6c9221
SCIP notification number (France)	2de6f2fd-eb66-4547-b3e4-bfa837255a24
SCIP notification number (Germany)	59d7a124-a9f8-48c5-b997-161fa3fa43a8
SCIP notification number (Hungary)	8682635c-6939-4c7e-bba2-638a1171044b
SCIP notification number (Italy)	6a3e1bf3-72af-4d1a-a294-a5e6d16cb2a5
SCIP notification number (Netherlands)	7590237b-ac77-4835-a844-d6ebe4ff2869
SCIP notification number (Poland)	59b02230-7773-4d71-aad8-7dc03ea62db6
SCIP notification number (Romania)	1daaba4f-fe96-4076-95a4-a2168f3eefd7
SCIP notification number (Sweden)	0791c229-1fde-4cbb-97a3-19ca5e4336ab

Subject to changes. Please also observe the further product documentation!

WAGO GmbH & Co. KG
 Hansastr. 27
 32423 Minden
 Phone: +49571 887-0 | Fax: +49571 887-169
 Email: info.de@wago.com | Web: www.wago.com

Do you have any questions about our products?
 We are always happy to take your call at +49 (571) 887-44222.

Approvals / Certificates







General approvals

Logo	Approval	Additional Approval Text	Certificate name
	UL UL International Germany GmbH (ORDINARY LOCATIONS)	UL 508	E175199 Sec.5

Optional accessories

Cables and pluggable connectors

Interconnecting cable

	Item no.: 756-3203/190-050 Connecting cable; 19-pole; Length: 5 m	www.wago.com/756-3203/190-050
	Item no.: 756-3203/190-100 Connecting cable; 19-pole; Length: 10 m	www.wago.com/756-3203/190-100
	Item no.: 756-3203/190-150 Connecting cable; 19-pole; Length: 15 m	www.wago.com/756-3203/190-150
	Item no.: 756-3204/190-050 Connecting cable; 19-pole; Length: 5 m	www.wago.com/756-3204/190-050
	Item no.: 756-3204/190-150 Connecting cable; 19-pole; Length: 15 m	www.wago.com/756-3204/190-150
	Item no.: 756-3204/190-100 Connecting cable; 19-pole; Length: 10 m	www.wago.com/756-3204/190-100

Marking accessories

Marking strip

	Item no.: 757-011 Marker card; not stretchable; snap-on type	www.wago.com/757-011
--	--	--

Marking devices

	Item no.: 210-110 Fiber-tip pen	www.wago.com/210-110
--	---	--

Subject to changes. Please also observe the further product documentation!

Cover

Cover

	Item no.: 756-8102 M12 protective cap; for unused sockets	www.wago.com/756-8102
--	---	--

Mounting

Intermediate plate

	Item no.: 757-080 Spacer module for sensor/actuator box; 8-way	www.wago.com/757-080
--	--	--

Downloads

Documentation

System Description

Sensor/Actuator Boxes – General Product Information	pdf	Download
	438.6 kB	

Additional Information

Disposal and Recycling	V 1.1.0	pdf	Download
Electrical and electronic equipment, Batteries, Packaging	2022 Aug 18	2.2 MB	

CAD/CAE-Data

CAD data

2D/3D Models 757-185	URL	Download
----------------------	-----	----------

CAE data

EPLAN Data Portal 757-185	URL	Download
---------------------------	-----	----------

ZUKEN Portal 757-185	URL	Download
----------------------	-----	----------

WSCAD Universe 757-185	URL	Download
------------------------	-----	----------

Environmental Product Compliance

Compliance Search

Environmental Product Compliance 757-185	URL	Download
--	-----	----------

Subject to changes. Please also observe the further product documentation!



M12 sensor/actuator box; 8-way; 5-pole; M23 connector

Installation Notes

Subject to changes. Please also observe the further product documentation!

WAGO GmbH & Co. KG
Hansastr. 27
32423 Minden
Phone: +49571 887-0 | Fax: +49571 887-169
Email: info.de@wago.com | Web: www.wago.com

Do you have any questions about our products?
We are always happy to take your call at +49 (571) 887-44222.