

THIS DRAWING IS UNPUBLISHED. RELEASED FOR PUBLICATION 2012
 © COPYRIGHT 2012 BY TE CONNECTIVITY ALL RIGHTS RESERVED.

LOC		DIST		REVISIONS			
P	LTR	DESCRIPTION	DATE	DWN	APVD		
F2		REVISED PER ECO-18-013833	17DEC2018	RS	MD		
G		REVISED PER ECO-20-007992	11JUN2020	BKW	SW		

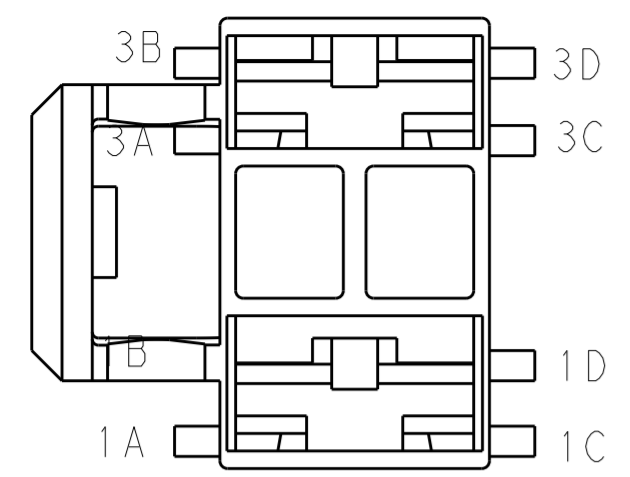

SPECIAL REAR VIEW THAT MATES WITH THE HEADER VIEWS BELOW SHOWING THE KEYING & POLARIZATION

2.79
[.110]

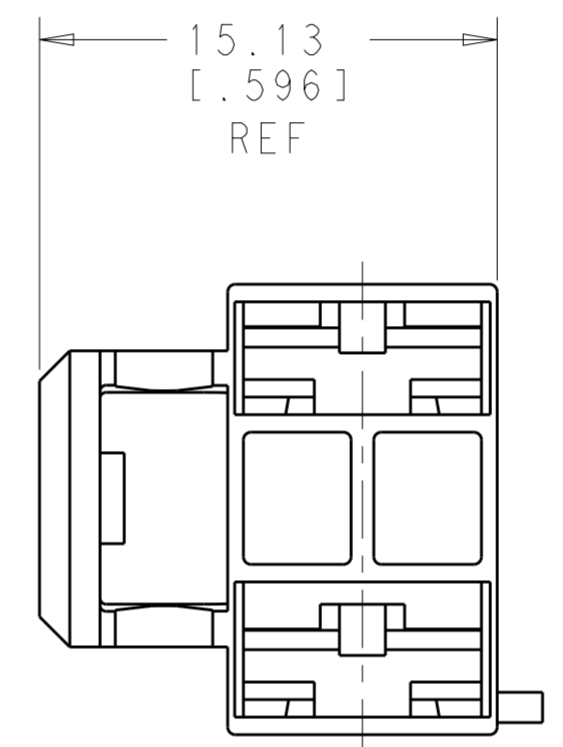
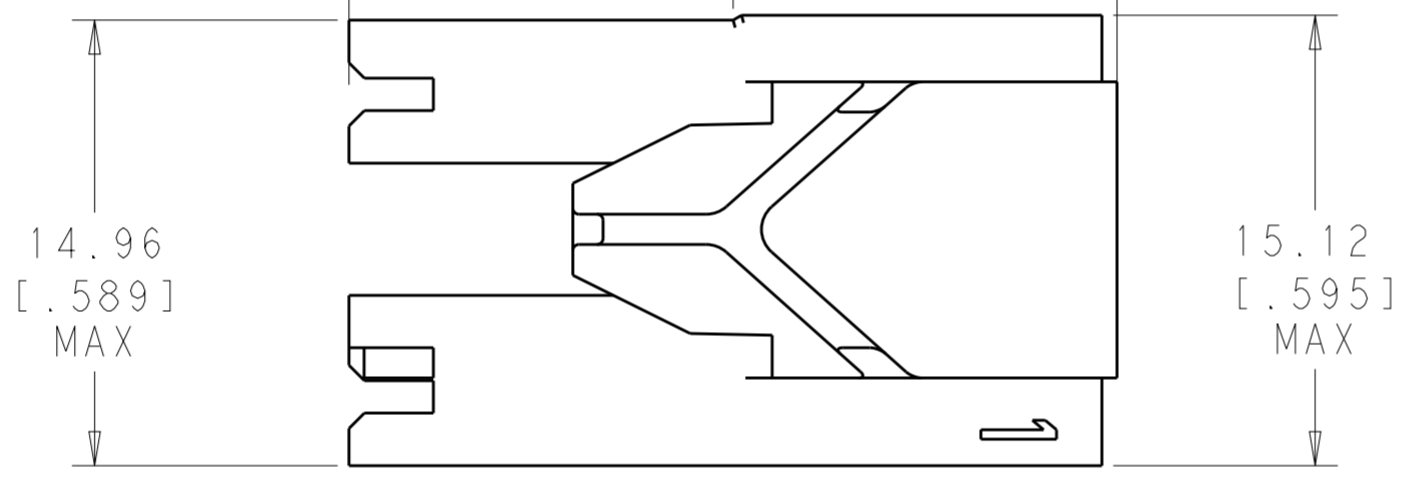
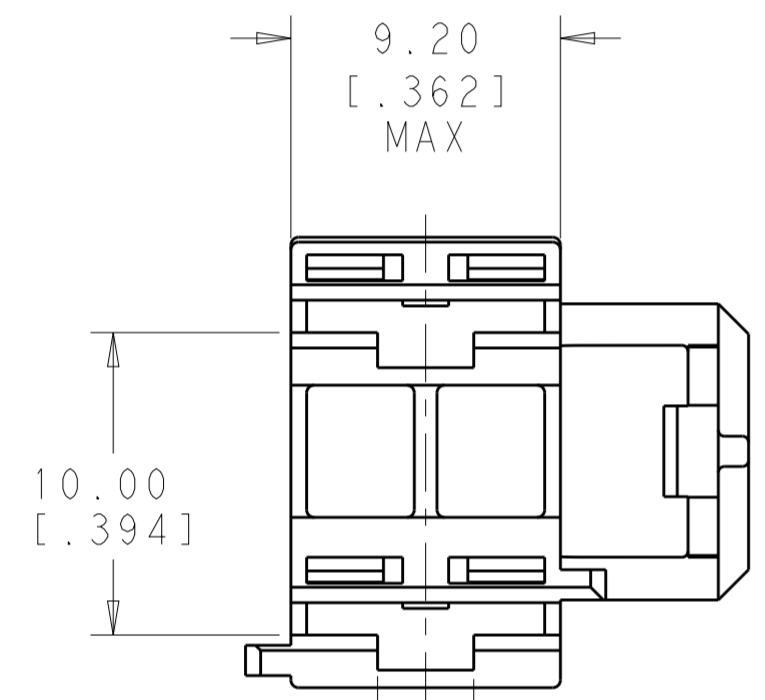
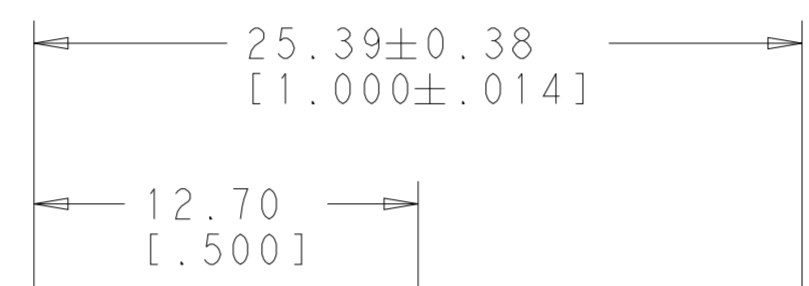
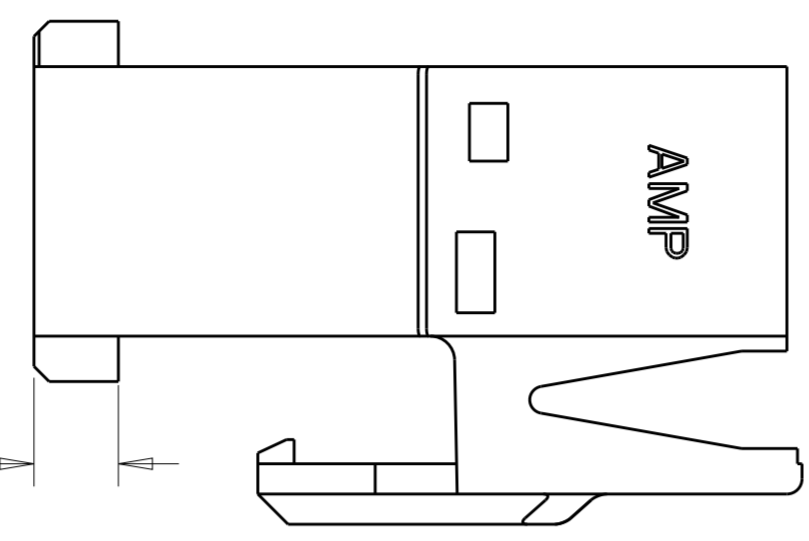

3.18±0.38
[.125±.014]

- 1 ACCORDING TO IEC 60335-1, GWPT 750°C WITHOUT FLAME
- 2 PRELIMINARY - NOT FOR PRODUCTION
- 3 DELETED NOTE
- 4 DELETED NOTE
- 5 ACCEPTS RECEPTACLES 2238135, 2238136, 1217378, 1217094 AND 1217095
- 6 OBSOLETE PARTS

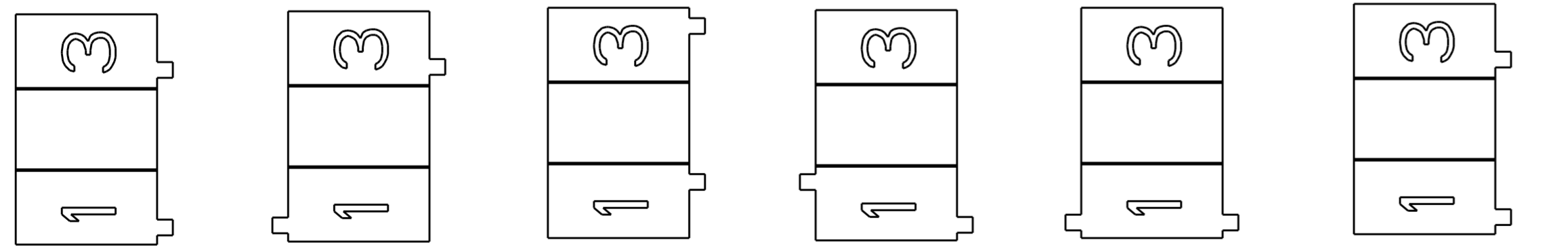

5-1969536-1 5-1969536-2 5-1969536-3 5-1969536-4 5-1969536-5 5-1969536-6

HEADER VIEWS

1	1C, 3C	NONE	GRAY	5-1969536-6
1	1C	1A	BLUE	5-1969536-5
1	1C	1B	BLACK	5-1969536-4
1	1D, 3D	NONE	NATURAL	5-1969536-3
1	3C	1A	YELLOW	5-1969536-2
1	1C, 3C	NONE	GREEN	5-1969536-1
6	1C, 3C	NONE	GRAY	5-1969536-6
6	1C	1A	BLUE	5-1969536-5
6	1C	1B	BLACK	5-1969536-4
6	1D, 3D	NONE	NATURAL	5-1969536-3
6	3C	1A	YELLOW	5-1969536-2
6	1C, 3C	NONE	GREEN	5-1969536-1
	KEYING FEATURE	POLARIZATION FEATURE	COLOR	PART NUMBER

THIS DRAWING IS A CONTROLLED DOCUMENT.

DWN: JR RUTH 19JUN2012
 CHK: F LUPO 15MAR2017
 APVD: R ROBONE 15MAR2017

STE TE Connectivity

NAME: HOUSING, RECEPT, POSI-LOCK MK III, 6.35 [.250] SERIES, 3 POSITION, 2 CIRCUIT

SIZE: A2 CAGE CODE: 00779 DRAWING NO: C-1969536 RESTRICTED TO: -

MATERIAL: NYLON TOLERANCES UNLESS OTHERWISE SPECIFIED: SEE TABLE

Customer Drawing SCALE: 4:1 SHEET 1 OF 1 REV G