

Mounting Option

.116 [2.95] I.D. Floating Eyelets

Contact Detail

90 Degree Bend (Code 527 Contacts)

.156 [3.96] Contact Spacing x .200 [5.08] Row Spacing

THIS IS A C.A.D. GENERATED DRAWING
DO NOT MAKE MANUAL REVISIONS TO MASTER.



ISSUE NUMBER

ORIGINAL

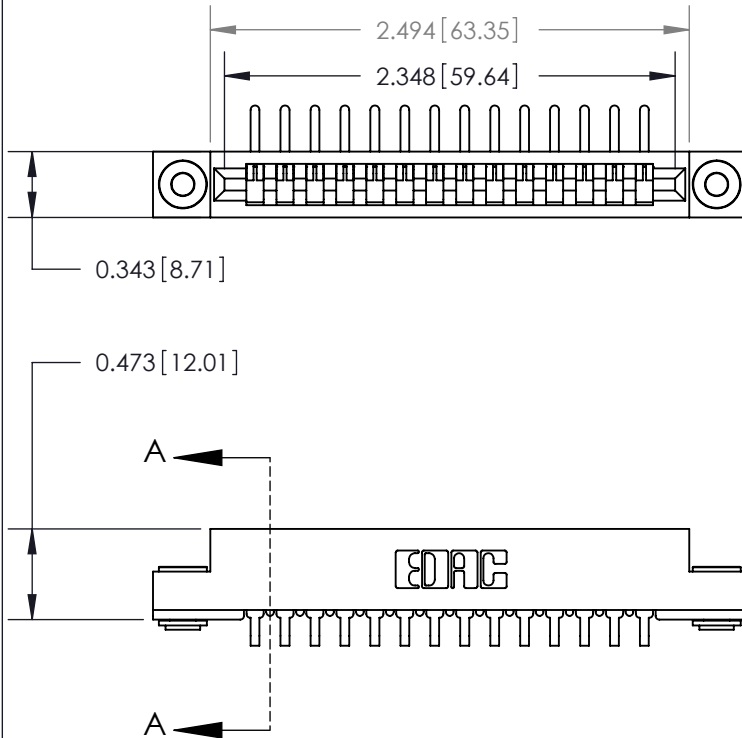

.095 [2.41] Point of Contact
(Measured from bottom of Card Slot)

SECTION A-A

Card Slot Accepts .054 [1.37]
to .070 [1.78] Thick P.C. Board

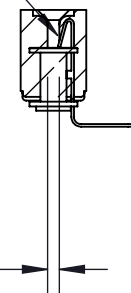

See Accompanying Page for:

- Contact Bend Details

807/857 Series High Temp Card Edge Connector

Part Number: 807-014-559-103

ACAD REFERENCE NO. 807 ENG MASTER

DRAWN: J.LEE DATE: AUG. 11/09

CHECKED: DATE:

SCALE: NTS SHEET 1 OF 2

DRAWING NUMBER ISSUE

807 Assembly

1



EDAC INC
TORONTO, ONTARIO
CANADA

YOUR CONNECTION TO QUALITY & SERVICE

THESE DRAWINGS AND SPECIFICATIONS
ARE THE PROPERTY OF EDAC INC. AND
SHALL NOT BE REPRODUCED, OR COPIED
OR USED AS THE BASIS FOR THE
MANUFACTURE OR SALE OF APPARATUS
WITHOUT WRITTEN PERMISSION.

Single Row Contacts - Read One Side of Daughter Board

THIS IS A C.A.D. GENERATED DRAWING
DO NOT MAKE MANUAL REVISIONS TO MASTER.



ISSUE NUMBER
ORIGINAL



558 Contact Code



559 Contact Code

Single Row Contacts - Read Both Sides of Daughter Board



553 Contact Code



554 Contact Code



557 Contact Code

Dual Row Contacts - Read Both Sides of Daughter Board



555 Contact Code



556 Contact Code

0.240 [6.10] Up to 27/54 Pin
0.162 [4.11] 28/56 and Over



558 Contact Code

0.240 [6.10] Up to 27/54 Pin
0.162 [4.11] 28/56 and Over
0.290 [7.37] Up to 27/54 Pin
.212 [5.38] 28/56 and Over



559 Contact Code



560 Contact Code

**807 Series High Temp Card Edge Connector
Contact Bend Detail**



EDAC INC
TORONTO, ONTARIO
CANADA

YOUR CONNECTION TO QUALITY & SERVICE

THESE DRAWINGS AND SPECIFICATIONS
ARE THE PROPERTY OF EDAC INC. AND
SHALL NOT BE REPRODUCED, OR COPIED
OR USED AS THE BASIS FOR THE
MANUFACTURE OR SALE OF APPARATUS
WITHOUT WRITTEN PERMISSION.

ACAD REFERENCE NO. 807 ENG MASTER

DRAWN: J.LEE DATE: AUG. 11/09

CHECKED: DATE:

SCALE: NTS SHEET 2 OF 2

DRAWING NUMBER ISSUE

807 Assembly

1