

Data sheet | Item number: 2202-1601

2-conductor through terminal block; with push-button; 2.5 mm²; with test option; same profile as 2-conductor disconnect terminal block; side and center marking; for DIN-rail 35 x 15 and 35 x 7.5; Push-in CAGE CLAMP®; 2,50 mm²; gray

www.wago.com/2202-1601

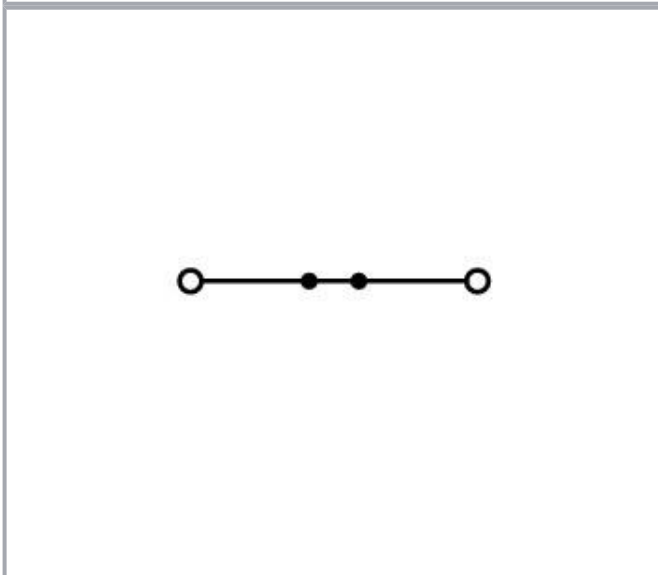
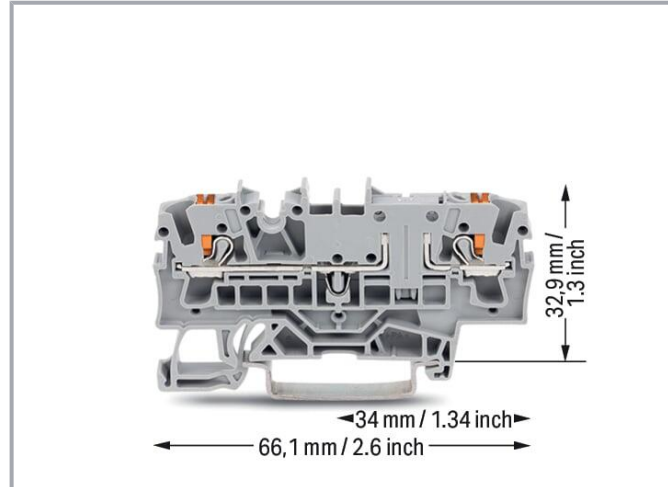
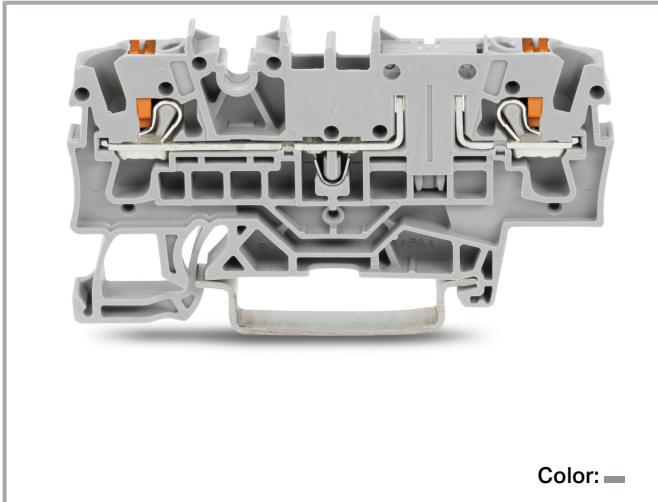

Data

Electrical data

Ratings per IEC/EN

Ratings per

IEC/EN 60947-7-1

Subject to changes. Please also observe the further product documentation!

WAGO GmbH & Co. KG
Hansastr. 27
32423 Minden
Phone: +49571 887-0 | Fax: +49571 887-169
Email: info.de@wago.com | Web: www.wago.com

Do you have any questions about our products?
We are always happy to take your call at +49 (571) 887-44222.



Nominal voltage (III/3)	400 V
Rated impulse voltage (III/3)	6 kV
Rated current	16 A
Legend (ratings)	(III / 3) \triangleq Overvoltage category III / Pollution degree 3

Ratings per UL 1059

Approvals per	UL 1059
Rated voltage UL (Use Group B)	300 V
Rated current UL (Use Group B)	15 A
Rated voltage UL (Use Group C)	300 V
Rated current UL (Use Group C)	15 A

Ratings per CSA

Approvals per	CSA 22.2 No 158
Rated voltage CSA (Use Group B)	300 V
Rated current CSA (Use Group B)	15 A
Rated voltage CSA (Use Group C)	300 V
Rated current CSA (Use Group C)	15 A

Ex information

Reference hazardous areas	See "Downloads – Documentation – Additional Information: Technical Section; Technical Explications"
Ratings per	ATEX: PTB 20 ATEX 1007 U / IECEx: PTB 20.0013U (Ex ec IIC Gc)
Rated voltage EN (Ex e II)	440 V
Rated current (Ex e II)	17 A

Power loss

Power loss, per pole (potential)	0.341 W
Rated current I_N for specified power loss	16 A
Resistance value for specified, current-dependent power loss	0.001 Ω

Connection data

Connection points	2
Total number of potentials	1
Number of levels	1
Number of jumper slots	2

Subject to changes. Please also observe the further product documentation!



Connection 1

Connection technology	Push-in CAGE CLAMP®
Actuation type	Push-button
Connectable conductor materials	Copper
Nominal cross-section	2.5 mm ²
Solid conductor	0.25 ... 4 mm ² / 22 ... 12 AWG
Solid conductor; push-in termination	0.75 ... 4 mm ² / 18 ... 12 AWG
Fine-stranded conductor	0.25 ... 4 mm ² / 22 ... 12 AWG
Fine-stranded conductor; with insulated ferrule	0.25 ... 2.5 mm ² / 22 ... 14 AWG
Fine-stranded conductor; with ferrule; push-in termination	1 ... 2.5 mm ² / 18 ... 14 AWG
Note (conductor cross-section)	Depending on the conductor characteristic, a conductor with a smaller cross-section can also be inserted via push-in termination.
Strip length	10 ... 12 mm / 0.39 ... 0.47 inches
Wiring direction	Front-entry wiring

Physical data

Width	5.2 mm / 0.205 inches
Height	66.1 mm / 2.602 inches
Depth from upper-edge of DIN-rail	32.9 mm / 1.295 inches

Mechanical Data

Mounting type	DIN-35 rail
Marking level	Center/side marking

Material Data

Note (material data)	Information on material specifications can be found here
Color	gray
Material group	I
Insulation material	Polyamide (PA66)
Flammability class per UL94	V0
Fire load	0.016 MJ
Weight	7.8 g

Subject to changes. Please also observe the further product documentation!

Environmental requirements

Processing temperature	-35 ... +85 °C
Continuous operating temperature	-60 ... +105 °C

Commercial data



ETIM 8.0	EC000897
ETIM 7.0	EC000897
PU (SPU)	50 pcs
Packaging type	box
Country of origin	DE
GTIN	4055143907576
Customs tariff number	85369010000

Environmental Product Compliance

RoHS Compliance Status	Compliant, No Exemption
------------------------	-------------------------

Approvals / Certificates

General approvals

Logo	Approval	Additional Approval Text	Certificate name
	CSA DEKRA Certification B.V.	C22.2	70173745
	UL Underwriters Laboratories Inc.	UL 1059	E45172
	UL Underwriters Laboratories Inc.	UL 1059	E45172

Declarations of conformity and manufacturer's declarations

Logo	Approval	Additional Approval Text	Certificate name
	EU-Declaration of Conformity WAGO GmbH & Co. KG	-	-



Subject to changes. Please also observe the further product documentation!



UK-Declaration of Conformity



WAGO GmbH & Co. KG

Approvals for hazardous areas

Logo	Approval	Additional Approval Text	Certificate name
	ATEX Physikalisch Technische Bundesanstalt	EN IEC 60079-0	PTB 20 ATEX 1007U (II 3 G Ex ec IIC Gc)
	CCC CNEX	-	2020312313000288 (Ex ec IIC Gc)
	IECEX Physikalisch Technische Bundesanstalt	IEC 60079	IECEX PTB 20.0013U (Ex ec IIC Gc)

Required accessories

End plate

End plate		
	Item no.: 209-191 Separator for Ex e/Ex i applications; 3 mm thick; 120 mm wide; orange	www.wago.com/209-191
	Item no.: 2002-1691 End and intermediate plate; 1 mm thick; gray	www.wago.com/2002-1691
	Item no.: 2002-1692 End and intermediate plate; 1 mm thick; orange	www.wago.com/2002-1692

Optional accessories

Jumpers

Jumper		
	Item no.: 210-123 Wire commoning chain; insulated; blue	www.wago.com/210-123
	Item no.: 2002-402	

Subject to changes. Please also observe the further product documentation!

WAGO GmbH & Co. KG

Hansastr. 27















32423 Minden

Phone: +49571 887-0 | Fax: +49571 887-169

Email: info.de@wago.com | Web: www.wago.com

Do you have any questions about our products?

We are always happy to take your call at +49 (571) 887-44222.

	Jumper; 2-way; insulated; light gray	www.wago.com/2002-402
	Item no.: 2002-402/000-005 Jumper; 2-way; insulated; red	www.wago.com/2002-402/000-005
	Item no.: 2002-400 Continuous jumper; 2-way; insulated; light gray	www.wago.com/2002-400
	Item no.: 2002-403 Jumper; 3-way; insulated; light gray	www.wago.com/2002-403
	Item no.: 2002-404/000-005 Jumper; 4-way; insulated; red	www.wago.com/2002-404/000-005
	Item no.: 2002-403/000-006 Jumper; 3-way; insulated; blue	www.wago.com/2002-403/000-006
	Item no.: 2002-404/000-006 Jumper; 4-way; insulated; blue	www.wago.com/2002-404/000-006
	Item no.: 2002-403/000-005 Jumper; 3-way; insulated; red	www.wago.com/2002-403/000-005
	Item no.: 2002-405/000-005 Jumper; 5-way; insulated; red	www.wago.com/2002-405/000-005
	Item no.: 2002-402/000-006 Jumper; 2-way; insulated; blue	www.wago.com/2002-402/000-006
	Item no.: 2002-405/000-006 Jumper; 5-way; insulated; blue	www.wago.com/2002-405/000-006
	Item no.: 2002-404 Jumper; 4-way; insulated; light gray	www.wago.com/2002-404
	Item no.: 2002-406/000-006 Jumper; 6-way; insulated; blue	www.wago.com/2002-406/000-006
	Item no.: 2002-406/000-005 Jumper; 6-way; insulated; red	www.wago.com/2002-406/000-005

Subject to changes. Please also observe the further product documentation!



Item no.: 2002-406/020-000
Delta jumper; insulated; light gray

www.wago.com/2002-406/020-000



Item no.: 2002-405
Jumper; 5-way; insulated; light gray

www.wago.com/2002-405



Item no.: 2002-407/000-005
Jumper; 7-way; insulated; red

www.wago.com/2002-407/000-005



Item no.: 2002-408
Jumper; 8-way; insulated; light gray

www.wago.com/2002-408



Item no.: 2002-408/000-006
Jumper; 8-way; insulated; blue

www.wago.com/2002-408/000-006



Item no.: 2002-405/011-000
Star point jumper; 3-way; insulated; light gray

www.wago.com/2002-405/011-000



Item no.: 2002-407/000-006
Jumper; 7-way; insulated; blue

www.wago.com/2002-407/000-006



Item no.: 2002-408/000-005
Jumper; 8-way; insulated; red

www.wago.com/2002-408/000-005



Item no.: 2002-407
Jumper; 7-way; insulated; light gray

www.wago.com/2002-407



Item no.: 2002-406
Jumper; 6-way; insulated; light gray

www.wago.com/2002-406



Item no.: 2002-410/000-005
Jumper; 10-way; insulated; red

















www.wago.com/2002-410/000-005



Item no.: 2002-410/000-006
Jumper; 10-way; insulated; blue

www.wago.com/2002-410/000-006

Subject to changes. Please also observe the further product documentation!

	Item no.: 2002-410 Jumper; 10-way; insulated; light gray	www.wago.com/2002-410
	Item no.: 2002-409/000-006 Jumper; 9-way; insulated; blue	www.wago.com/2002-409/000-006
	Item no.: 2002-409/000-005 Jumper; 9-way; insulated; red	www.wago.com/2002-409/000-005
	Item no.: 2002-409 Jumper; 9-way; insulated; light gray	www.wago.com/2002-409
	Item no.: 2002-423/000-006 Continuous jumper; from 1 to 3; insulated; blue	www.wago.com/2002-423/000-006
	Item no.: 2002-423 Continuous jumper; from 1 to 3; insulated; light gray	www.wago.com/2002-423
	Item no.: 2002-433 Jumper; from 1 to 3; insulated; light gray	www.wago.com/2002-433
	Item no.: 2002-434 Jumper; from 1 to 4; insulated; light gray	www.wago.com/2002-434
	Item no.: 2002-423/000-005 Continuous jumper; from 1 to 3; insulated; red	www.wago.com/2002-423/000-005
	Item no.: 2002-435 Jumper; from 1 to 5; insulated; light gray	www.wago.com/2002-435
	Item no.: 2002-436 Jumper; from 1 to 6; insulated; light gray	www.wago.com/2002-436
	Item no.: 2002-437 Jumper; from 1 to 7; insulated; light gray	www.wago.com/2002-437
	Item no.: 2002-438 Jumper; from 1 to 8; insulated; light gray	www.wago.com/2002-438
	Item no.: 2002-439 Jumper; from 1 to 9; insulated; light gray	www.wago.com/2002-439
	Item no.: 2002-440 Jumper; from 1 to 10; insulated; light gray	www.wago.com/2002-440
	Item no.: 2002-472	www.wago.com/2002-472

Subject to changes. Please also observe the further product documentation!

Staggered jumper; 2-way; insulated; light gray



Item no.: 2002-473

Staggered jumper; 3-way; insulated; light gray

www.wago.com/2002-473



Item no.: 2002-475/011-000

Staggered jumper; 3-way; insulated; light gray

www.wago.com/2002-475/011-000



Item no.: 2002-475

Staggered jumper; 5-way; insulated; light gray

www.wago.com/2002-475



Item no.: 2002-476

Staggered jumper; 6-way; insulated; light gray

www.wago.com/2002-476



Item no.: 2002-474

Staggered jumper; 4-way; insulated; light gray

www.wago.com/2002-474



Item no.: 2002-477

Staggered jumper; 7-way; insulated; light gray

www.wago.com/2002-477



Item no.: 2002-473/011-000

Staggered jumper; 2-way; from 1 to 3; insulated; light gray

www.wago.com/2002-473/011-000



Item no.: 2002-479

Staggered jumper; 9-way; insulated; light gray

www.wago.com/2002-479



Item no.: 2002-478

Staggered jumper; 8-way; insulated; light gray

www.wago.com/2002-478



Item no.: 2002-479/011-000

Staggered jumper; insulated; light gray

www.wago.com/2002-479/011-000



Item no.: 2002-480

Staggered jumper; 10-way; insulated; light gray

www.wago.com/2002-480



Item no.: 2002-477/011-000

Staggered jumper; insulated; light gray

www.wago.com/2002-477/011-000



Item no.: 2002-481/011-000

Staggered jumper; insulated; light gray

www.wago.com/2002-481/011-000



Item no.: 2002-481

Staggered jumper; 11-way; insulated; light gray

www.wago.com/2002-481



Item no.: 2002-482

Staggered jumper; 12-way; insulated; light gray

www.wago.com/2002-482

Subject to changes. Please also observe the further product documentation!

WAGO GmbH & Co. KG

Hansastr. 27

32423 Minden

Phone: +49571 887-0 | Fax: +49571 887-169

Email: info.de@wago.com | Web: www.wago.com

Do you have any questions about our products?

We are always happy to take your call at +49 (571) 887-44222.

**Item no.: 210-103**

Wire commoning chain; insulated; black

www.wago.com/210-103**Item no.: 2002-424/000-006**

Continuous jumper; from 1 to 4; insulated; blue

www.wago.com/2002-424/000-006**Tool**

Operating tool

**Item no.: 210-658**

Operating tool; Blade: 3.5 x 0.5 mm; with a partially insulated shaft; angled; short; multicoloured

www.wago.com/210-658**Item no.: 210-720**

Operating tool; Blade: 3.5 x 0.5 mm; with a partially insulated shaft; multicoloured

www.wago.com/210-720**Plugs**

Diode plug

**Item no.: 2002-880/1000-411**

Component plug; 2-pole; with diode 1N4007; 10.4 mm wide; Operating temperature 85°C max.; gray

www.wago.com/2002-880/1000-411

LED plug

**Item no.: 2002-880/1000-541**

Component plug; 2-pole; LED (red); 10.4 mm wide; Operating temperature 85°C max.; gray

www.wago.com/2002-880/1000-541**Item no.: 2002-880/1000-542**

Component plug; 2-pole; LED (red); 10.4 mm wide; Operating temperature 85°C max.; multicoloured

www.wago.com/2002-880/1000-542**Item no.: 2002-880/1000-836**

Component plug; 2-pole; LED (red); 10.4 mm wide; Operating temperature 85°C max.; gray

www.wago.com/2002-880/1000-836

Empty component plug housing

**Item no.: 2002-880**

Empty component plug housing; 10.4 mm wide; 2-pole; Type 4; gray

www.wago.com/2002-880**Carrier rail**

Mounting accessories

**Item no.: 210-197**

Steel carrier rail; 35 x 15 mm; 1.5 mm thick; 2 m long; slotted; similar to EN 60715; silver-colored

www.wago.com/210-197**Item no.: 210-198**

Copper carrier rail; 35 x 15 mm; 2.3 mm thick; 2 m long; unslotted; according to EN 60715; copper-colored

www.wago.com/210-198

Subject to changes. Please also observe the further product documentation!

WAGO GmbH & Co. KG

Hansastr. 27

32423 Minden

Phone: +49571 887-0 | Fax: +49571 887-169

Email: info.de@wago.com | Web: www.wago.com

Do you have any questions about our products?

We are always happy to take your call at +49 (571) 887-44222.

	Item no.: 210-504 Steel carrier rail; 35 x 7.5 mm; 1 mm thick; 2 m long; slotted; galvanized; according to EN 60715; silver-colored	www.wago.com/210-504
	Item no.: 210-505 Steel carrier rail; 35 x 7.5 mm; 1 mm thick; 2 m long; unslotted; galvanized; according to EN 60715; silver-colored	www.wago.com/210-505
	Item no.: 210-506 Steel carrier rail; 35 x 15 mm; 1.5 mm thick; 2 m long; unslotted; galvanized; similar to EN 60715; silver-colored	www.wago.com/210-506
	Item no.: 210-508 Steel carrier rail; 35 x 15 mm; 1.5 mm thick; 2 m long; slotted; galvanized; similar to EN 60715; silver-colored	www.wago.com/210-508
	Item no.: 210-113 Steel carrier rail; 35 x 7.5 mm; 1 mm thick; 2 m long; unslotted; according to EN 60715; silver-colored	www.wago.com/210-113
	Item no.: 210-118 Steel carrier rail; 35 x 15 mm; 2.3 mm thick; 2 m long; unslotted; according to EN 60715; silver-colored	www.wago.com/210-118
	Item no.: 210-112 Steel carrier rail; 35 x 7.5 mm; 1 mm thick; 2 m long; slotted; according to EN 60715; "Hole width 25 mm; silver-colored	www.wago.com/210-112
	Item no.: 210-114 Steel carrier rail; 35 x 15 mm; 1.5 mm thick; 2 m long; unslotted; similar to EN 60715; silver-colored	www.wago.com/210-114
	Item no.: 210-115 Steel carrier rail; 35 x 7.5 mm; 1 mm thick; 2 m long; slotted; according to EN 60715; "Hole width 18 mm; silver-colored	www.wago.com/210-115
	Item no.: 210-196 Aluminum carrier rail; 35 x 8.2 mm; 1.6 mm thick; 2 m long; unslotted; similar to EN 60715; silver-colored	www.wago.com/210-196

Mounting

Cover carrier

	Item no.: 709-169 Cover carrier; Type 3; gray	www.wago.com/709-169
--	---	--

Cover

	Item no.: 709-156 Cover; Type 3; suitable for cover carrier, type 3; 1 m long; transparent	www.wago.com/709-156
--	--	--

Insulation stop

Insulation stop

	Item no.: 2002-171 Insulation stop; 0.25 - 0.5 mm ² ; 5 pieces/strip; light gray	www.wago.com/2002-171
--	---	--

Subject to changes. Please also observe the further product documentation!



Item no.: 2002-172
Insulation stop; 0.75 - 1 mm²; 5 pieces/strip; dark gray

www.wago.com/2002-172

Testing and measuring

Testing accessories



Item no.: 2009-174
Test plug adapter; for 4 mm Ø test plugs; for testing TOPJOB®S rail-mounted terminal blocks; gray

www.wago.com/2009-174



Item no.: 2009-182
Testing tap; for max. 2.5 mm²; tool-free connection for individual test wires 0.08 - 2.5 mm; gray

www.wago.com/2009-182



Item no.: 2002-511
Modular TOPJOB®S connector; modular; for jumper contact slot; 1-pole; 2,50 mm²; gray

www.wago.com/2002-511



Item no.: 2002-549
Spacer module; modular; e.g., for bridging commoned terminal blocks; gray

www.wago.com/2002-549



Item no.: 2002-552
Modular TOPJOB®S connector; modular; for jumper contact slot; 2-pole; 2,50 mm²; gray

www.wago.com/2002-552



Item no.: 2002-558
Modular TOPJOB®S connector; modular; for jumper contact slot; 8-pole; 2,50 mm²; gray

www.wago.com/2002-558



Item no.: 2002-559
Modular TOPJOB®S connector; modular; for jumper contact slot; 9-pole; 2,50 mm²; gray

www.wago.com/2002-559



Item no.: 2002-556
Modular TOPJOB®S connector; modular; for jumper contact slot; 6-pole; 2,50 mm²; gray

www.wago.com/2002-556



Item no.: 2002-553
Modular TOPJOB®S connector; modular; for jumper contact slot; 3-pole; 2,50 mm²; gray

www.wago.com/2002-553



Item no.: 2002-560
Modular TOPJOB®S connector; modular; for jumper contact slot; 10-pole; 2,50 mm²; gray

www.wago.com/2002-560



Item no.: 2002-554
Modular TOPJOB®S connector; modular; for jumper contact slot; 4-pole; 2,50 mm²; gray

www.wago.com/2002-554



Item no.: 2002-555
Modular TOPJOB®S connector; modular; for jumper contact slot; 5-pole; 2,50 mm²; gray

www.wago.com/2002-555



Item no.: 2002-557
Modular TOPJOB®S connector; modular; for jumper contact slot; 7-pole; 2,50 mm²; gray

www.wago.com/2002-557



Item no.: 2002-649
TOPJOB®S L-type spacer module; modular; e.g., for bridging commoned terminal blocks; gray

www.wago.com/2002-649



Item no.: 210-136
Test plug; 2 mm Ø; with 500 mm cable; red

www.wago.com/210-136

Subject to changes. Please also observe the further product documentation!

Marking accessories

Marking strip

**Item no.: 2009-110**

Marking strips; for Smart Printer; on reel; not stretchable; plain; snap-on type; white

www.wago.com/2009-110

Marker carrier

**Item no.: 2009-198**

Adaptor; gray

www.wago.com/2009-198**Item no.: 2002-121**

Adaptor; gray

www.wago.com/2002-121**Item no.: 2002-161**

Adaptor; gray

www.wago.com/2002-161

Marker

**Item no.: 2009-115/000-002**

WMB-Inline; for Smart Printer; 1500 pieces on roll; stretchable 5 - 5.2 mm; plain; snap-on type; yellow

www.wago.com/2009-115/000-002**Item no.: 2009-115/000-007**

WMB-Inline; for Smart Printer; 1500 pieces on roll; stretchable 5 - 5.2 mm; plain; snap-on type; gray

www.wago.com/2009-115/000-007**Item no.: 2009-115/000-017**

WMB-Inline; for Smart Printer; 1500 pieces on roll; stretchable 5 - 5.2 mm; plain; snap-on type; light green

www.wago.com/2009-115/000-017**Item no.: 2009-115/000-023**

WMB-Inline; for Smart Printer; 1500 pieces on roll; stretchable 5 - 5.2 mm; plain; snap-on type; green

www.wago.com/2009-115/000-023**Item no.: 2009-115/000-024**

WMB-Inline; for Smart Printer; 1500 pieces on roll; stretchable 5 - 5.2 mm; plain; snap-on type; violet

www.wago.com/2009-115/000-024**Item no.: 2009-145/000-006**

Mini-WSB Inline; for Smart Printer; 1700 pieces on roll; stretchable 5 - 5.2 mm; plain; snap-on type; blue

www.wago.com/2009-145/000-006**Item no.: 2009-145**

Mini-WSB Inline; for Smart Printer; 1700 pieces on roll; stretchable 5 - 5.2 mm; plain; snap-on type; white

www.wago.com/2009-145**Item no.: 2009-145/000-002**

Mini-WSB Inline; for Smart Printer; 1700 pieces on roll; stretchable 5 - 5.2 mm; plain; snap-on type; yellow

www.wago.com/2009-145/000-002

Subject to changes. Please also observe the further product documentation!

WAGO GmbH & Co. KG

Hansastr. 27













32423 Minden

Phone: +49571 887-0 | Fax: +49571 887-169

Email: info.de@wago.com | Web: www.wago.com

Do you have any questions about our products?

We are always happy to take your call at +49 (571) 887-44222.

	<p>Item no.: 2009-145/000-007 Mini-WSB Inline; for Smart Printer; 1700 pieces on roll; stretchable 5 - 5.2 mm; plain; snap-on type; gray</p>	<p>www.wago.com/2009-145/000-007</p>
	<p>Item no.: 2009-145/000-005 Mini-WSB Inline; for Smart Printer; 1700 pieces on roll; stretchable 5 - 5.2 mm; plain; snap-on type; red</p>	<p>www.wago.com/2009-145/000-005</p>
	<p>Item no.: 2009-145/000-012 Mini-WSB Inline; for Smart Printer; 1700 pieces on roll; stretchable 5 - 5.2 mm; plain; snap-on type; orange</p>	<p>www.wago.com/2009-145/000-012</p>
	<p>Item no.: 2009-145/000-023 Mini-WSB Inline; for Smart Printer; 1700 pieces on roll; stretchable 5 - 5.2 mm; plain; snap-on type; green</p>	<p>www.wago.com/2009-145/000-023</p>
	<p>Item no.: 2009-145/000-024 Mini-WSB Inline; for Smart Printer; 1700 pieces on roll; stretchable 5 - 5.2 mm; plain; snap-on type; violet</p>	<p>www.wago.com/2009-145/000-024</p>
	<p>Item no.: 2009-115 WMB-Inline; for Smart Printer; 1500 pieces on roll; stretchable 5 - 5.2 mm; plain; snap-on type; white</p>	<p>www.wago.com/2009-115</p>
	<p>Item no.: 248-501/000-006 Mini-WSB marking card; as card; not stretchable; plain; snap-on type; blue</p>	<p>www.wago.com/248-501/000-006</p>
	<p>Item no.: 248-501/000-007 Mini-WSB marking card; as card; not stretchable; plain; snap-on type; gray</p>	<p>www.wago.com/248-501/000-007</p>
	<p>Item no.: 248-501/000-002 Mini-WSB marking card; as card; not stretchable; plain; snap-on type; yellow</p>	<p>www.wago.com/248-501/000-002</p>
	<p>Item no.: 248-501/000-012 Mini-WSB marking card; as card; not stretchable; plain; snap-on type; orange</p>	<p>www.wago.com/248-501/000-012</p>
	<p>Item no.: 248-501 Mini-WSB marking card; as card; not stretchable; plain; snap-on type; white</p>	<p>www.wago.com/248-501</p>
	<p>Item no.: 248-501/000-017 Mini-WSB marking card; as card; not stretchable; plain; snap-on type; light green</p>	<p>www.wago.com/248-501/000-017</p>

Subject to changes. Please also observe the further product documentation!



Item no.: 248-501/000-005
Mini-WSB marking card; as card; not stretchable; plain; snap-on type; red

www.wago.com/248-501/000-005



Item no.: 248-501/000-024
Mini-WSB marking card; as card; not stretchable; plain; snap-on type; violet

www.wago.com/248-501/000-024



Item no.: 248-501/000-023
Mini-WSB marking card; as card; not stretchable; plain; snap-on type; green

www.wago.com/248-501/000-023



Item no.: 793-5501/000-007
WMB marking card; as card; for terminal block width 5 - 17.5 mm; stretchable 5 - 5.2 mm; plain; snap-on type; gray

www.wago.com/793-5501/000-007



Item no.: 793-5501/000-012
WMB marking card; as card; for terminal block width 5 - 17.5 mm; stretchable 5 - 5.2 mm; plain; snap-on type; orange

www.wago.com/793-5501/000-012



Item no.: 793-5501/000-014
WMB marking card; as card; for terminal block width 5 - 17.5 mm; stretchable 5 - 5.2 mm; plain; snap-on type; brown

www.wago.com/793-5501/000-014



Item no.: 793-5501/000-017
WMB marking card; as card; for terminal block width 5 - 17.5 mm; stretchable 5 - 5.2 mm; plain; snap-on type; light green

www.wago.com/793-5501/000-017



Item no.: 793-5501/000-023
WMB marking card; as card; for terminal block width 5 - 17.5 mm; stretchable 5 - 5.2 mm; plain; snap-on type; green

www.wago.com/793-5501/000-023



Item no.: 793-5501/000-024
WMB marking card; as card; for terminal block width 5 - 17.5 mm; stretchable 5 - 5.2 mm; plain; snap-on type; violet

www.wago.com/793-5501/000-024



Item no.: 793-5501/000-005
WMB marking card; as card; for terminal block width 5 - 17.5 mm; stretchable 5 - 5.2 mm; plain; snap-on type; red

www.wago.com/793-5501/000-005

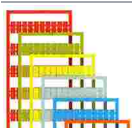

Item no.: 793-5501/000-002
WMB marking card; as card; for terminal block width 5 - 17.5 mm; stretchable 5 - 5.2 mm; plain; snap-on type; yellow

www.wago.com/793-5501/000-002

Subject to changes. Please also observe the further product documentation!



Item no.: 793-5501/000-006

WMB marking card; as card; for terminal block width 5 - 17.5 mm; stretchable 5 - 5.2 mm; plain; snap-on type; blue www.wago.com/793-5501/000-006



Item no.: 793-5501

WMB marking card; as card; for terminal block width 5 - 17.5 mm; stretchable 5 - 5.2 mm; plain; snap-on type; white www.wago.com/793-5501



Item no.: 2009-115/000-012

WMB-Inline; for Smart Printer; 1500 pieces on roll; stretchable 5 - 5.2 mm; plain; snap-on type; orange www.wago.com/2009-115/000-012



Item no.: 2009-115/000-006

WMB-Inline; for Smart Printer; 1500 pieces on roll; stretchable 5 - 5.2 mm; plain; snap-on type; blue www.wago.com/2009-115/000-006



Item no.: 2009-115/000-005

WMB-Inline; for Smart Printer; 1500 pieces on roll; stretchable 5 - 5.2 mm; plain; snap-on type; red www.wago.com/2009-115/000-005

Group marker carrier



Item no.: 2009-193

Group marker carrier; gray www.wago.com/2009-193



Item no.: 2009-192

Group marker carrier; gray www.wago.com/2009-192



Item no.: 2009-191

Group marker carrier; gray www.wago.com/2009-191

Push-in type wire jumper

Jumper



Item no.: 2009-412

Push-in type wire jumper; insulated; 60 mm long; black www.wago.com/2009-412



Item no.: 2009-414

Push-in type wire jumper; 1.5 mm²; insulated; 110 mm long; black www.wago.com/2009-414



Item no.: 2009-416

Push-in type wire jumper; 1.5 mm²; insulated; 250 mm long; black www.wago.com/2009-416



Item no.: 2009-414/000-005

Push-in type wire jumper; 1.5 mm²; insulated; 110 mm long; black www.wago.com/2009-414/000-005



Item no.: 2009-414/000-006

Push-in type wire jumper; insulated; 110 mm long; black www.wago.com/2009-414/000-006

Ferrule

Ferrule



Item no.: 216-241

Subject to changes. Please also observe the further product documentation!

WAGO GmbH & Co. KG

Hansastr. 27

32423 Minden

Phone: +49571 887-0 | Fax: +49571 887-169

Email: info.de@wago.com | Web: www.wago.com

Do you have any questions about our products?

We are always happy to take your call at +49 (571) 887-44222.



	Ferrule; Sleeve for 0.5 mm ² / 20 AWG; insulated; electro-tin plated; electrolytic copper; gastight crimped; acc. to DIN 46228, Part 4/09.90; white	www.wago.com/216-241
	Item no.: 216-242 Ferrule; Sleeve for 0.75 mm ² / 18 AWG; insulated; electro-tin plated; electrolytic copper; gastight crimped; acc. to DIN 46228, Part 4/09.90; gray	www.wago.com/216-242
	Item no.: 216-243 Ferrule; Sleeve for 1 mm ² / AWG 18; insulated; electro-tin plated; electrolytic copper; gastight crimped; acc. to DIN 46228, Part 4/09.90; red	www.wago.com/216-243
	Item no.: 216-244 Ferrule; Sleeve for 1.5 mm ² / AWG 16; insulated; electro-tin plated; electrolytic copper; gastight crimped; acc. to DIN 46228, Part 4/09.90; black	www.wago.com/216-244
	Item no.: 216-263 Ferrule; Sleeve for 1 mm ² / AWG 18; insulated; electro-tin plated; electrolytic copper; gastight crimped; acc. to DIN 46228, Part 4/09.90; red	www.wago.com/216-263
	Item no.: 216-246 Ferrule; Sleeve for 2.5 mm ² / AWG 14; insulated; electro-tin plated; electrolytic copper; gastight crimped; acc. to DIN 46228, Part 4/09.90; blue	www.wago.com/216-246
	Item no.: 216-266 Ferrule; Sleeve for 2.5 mm ² / AWG 14; insulated; electro-tin plated; electrolytic copper; gastight crimped; acc. to DIN 46228, Part 4/09.90; blue	www.wago.com/216-266
	Item no.: 216-264 Ferrule; Sleeve for 1.5 mm ² / AWG 16; insulated; electro-tin plated; electrolytic copper; gastight crimped; acc. to DIN 46228, Part 4/09.90; black	www.wago.com/216-264
	Item no.: 216-262 Ferrule; Sleeve for 0.75 mm ² / 18 AWG; insulated; electro-tin plated; electrolytic copper; gastight crimped; acc. to DIN 46228, Part 4/09.90; gray	www.wago.com/216-262

Downloads

Documentation

Bid Text

2202-1601 docx - Datei	2019 May 20	docx 15.2 kB	Download
---------------------------	-------------	-----------------	----------

2202-1601 X81 - Datei	2019 May 20	xml 4.2 kB	Download
--------------------------	-------------	---------------	----------

Additional Information

Technical Section Technical explanations		pdf 2.2 MB	Download
---	--	---------------	----------

Subject to changes. Please also observe the further product documentation!

WAGO GmbH & Co. KG
Hansastr. 27
32423 Minden
Phone: +49571 887-0 | Fax: +49571 887-169
Email: info.de@wago.com | Web: www.wago.com

Do you have any questions about our products?
We are always happy to take your call at +49 (571) 887-44222.

CAD/CAE-Data

CAD data

2D/3D Models 2202-1601

[URL](#)

[Download](#)

Environmental Product Compliance

Compliance Search

Environmental Product Compliance 2202-1601

[URL](#)

[Download](#)

2-conductor through terminal block; with push-button; 2.5 mm²; with test option; same profile as 2-conductor disconnect terminal block; side and center marking; for DIN-rail 35 x 15 and 35 x 7.5; Push-in CAGE CLAMP®; 2,50 mm²; gray

Installation Notes

Conductor termination

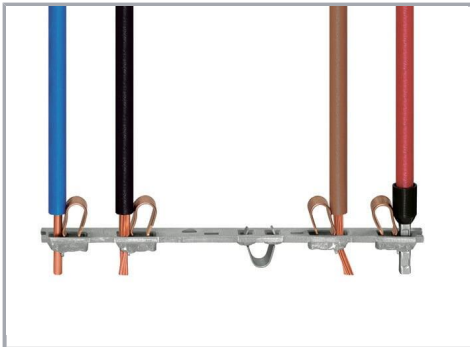

All conductor types at a glance



Push-in termination of solid and ferruled conductors

Subject to changes. Please also observe the further product documentation!

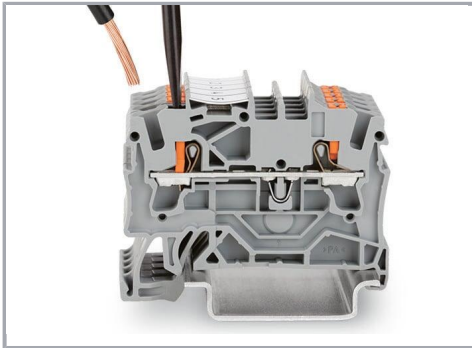

Insert fine-stranded conductors via operating tool.



Removing all conductors via operating tool.

Commoning



Insert a push-in type jumper bar and push down until it hits the backstop.

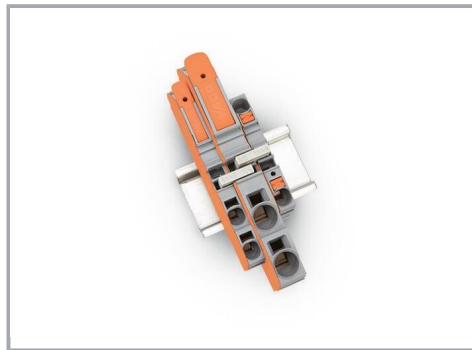

Commoning with step-down jumpers.

Testing

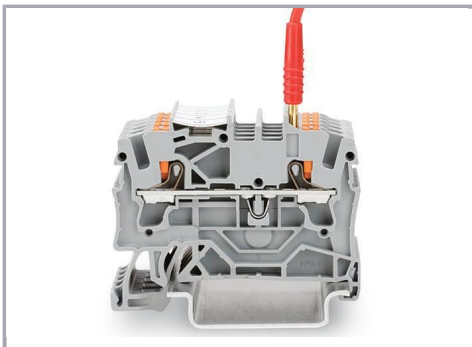

Testing with a 2 mm \varnothing test plug (max. 42 V).

Marking

Subject to changes. Please also observe the further product documentation!

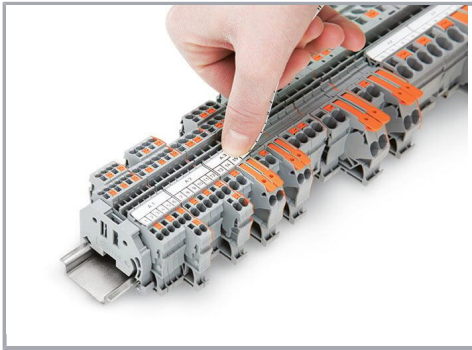

Snapping a marking strip into a marker slot.

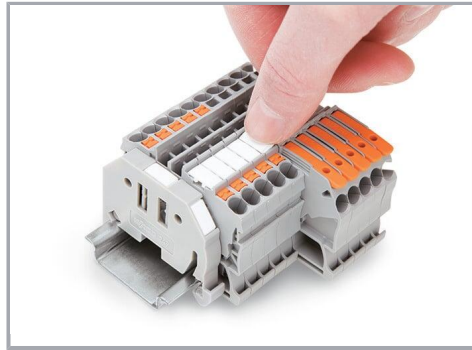

Snapping a marking strip into the marker slot.

Product family

TOPJOB® S

TOPJOB® S: In various industrial applications and modern building installations, WAGO's wide and versatile range of rail-mount terminal blocks provides more than just reliable electrical connections.

[Show all products from the family](#)

Subject to changes. Please also observe the further product documentation!