

Low Input / Output 1.5 A Low Dropout Regulator

No.EA-585-230118

OVERVIEW

The RP120 is a very low dropout regulator which operates from input voltage as low as 0.768 V (@ $V_{SET} = 0.6$ V, $V_{BIAS} = 3.3$ V, $I_{OUT} = 1.5$ A). The LDO uses an internal low on-resistance (67 m Ω @ $V_{SET} = 0.6$ V, $V_{BIAS} = 3.3$ V, $I_{OUT} = 1$ A) NMOS transistor as the driver. The VBIAS pin provides the higher supply necessary for the LDO circuitry while the output current comes directly from the VIN input for high efficiency regulation.

KEY BENEFITS

- High PSRR, high output current, and fast response characteristics.
- Suitable for sensitive sensors, high-quality audio, and RF devices.
- Very small WLCSP package (1.2 mm x 0.8 mm x 0.29 mm).

KEY SPECIFICATIONS

- Input Voltage Range :
 $V_{IN} = V_{SET} + V_{DIFF}$ to V_{BIAS}
 (Ex. Min. 0.768 V @ $V_{SET} = 0.6$ V, $V_{BIAS} = 3.3$ V, $I_{OUT} = 1.5$ A)
 $V_{BIAS} = 2.4$ V to 5.5 V
- Output Voltage Setting Range:
 Internal Fixed Type: 0.6 V to 2.0 V
 Adjustable Output Type: 0.6 V to 3.6 V
- Output Current: $I_{OUTMAX} = 1.5$ A
- Supply Current: Typ. 35 μ A
- Output Noise: Typ. 50 μ Vrms ($V_{SET} = 0.6$ V)
- Power Supply Ripple Rejection:
 Typ. 95 dB ($f = 1$ kHz, Ripple in V_{IN})
 Typ. 60 dB ($f = 100$ kHz, Ripple in V_{IN})
- Dropout Voltage: Typ. 102 mV
 ($I_{OUT} = 1.5$ A, $V_{SET} = 0.6$ V, $V_{BIAS} = 3.3$ V)
- Inrush Current Limit: Typ. 600 mA
- Short Circuit Current Protection: Typ. 600 mA
- Thermal Shutdown: Typ. 165 $^{\circ}$ C
- Ceramic Capacitor: C_{OUT} 4.7 μ F

TYPICAL APPLICATION

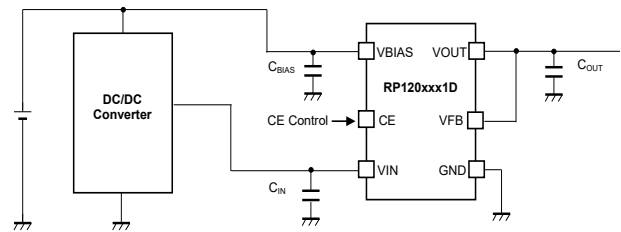

RP120 (Internal Fixed Type)
Typical Application Circuit

PACKAGE (unit: mm)

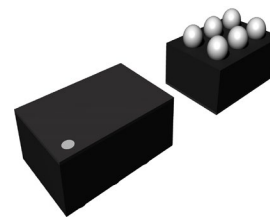

WLCSP-6-P11
1.2 x 0.8 x 0.29

APPLICATIONS

- Portable communication devices, battery-powered devices, camera, video, audio.
- Communication devices such as RF modules, clock generation devices such as VCOs and PLLs.
- Constant voltage source for analog circuits of FPGA and SoC.

SELECTION GUIDE

SELECTION GUIDE

Product Name	Package	Quantity per Reel	Pb Free	Halogen Free
RP120Zxx1Dy-E2-F	WLCSP-6-P11	5,000 pcs	YES	YES

xx: Specify the output voltage from 0.6 V (06) to 2.0 V (20) in 0.1 V increments.

Output voltage external setting type is fixed to (00).

y : Used when specifying in units of 10mv such as 0.75V

Example: RP120Z071D5

BLOCK DIAGRAM

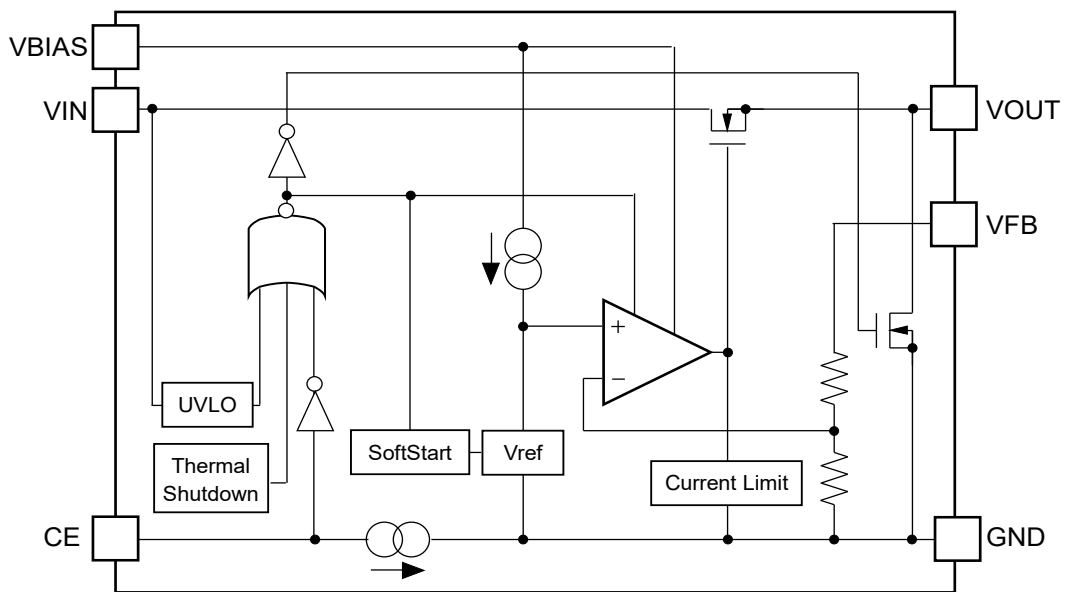

RP120xxx1D Block Diagram

PIN DESCRIPTIONS

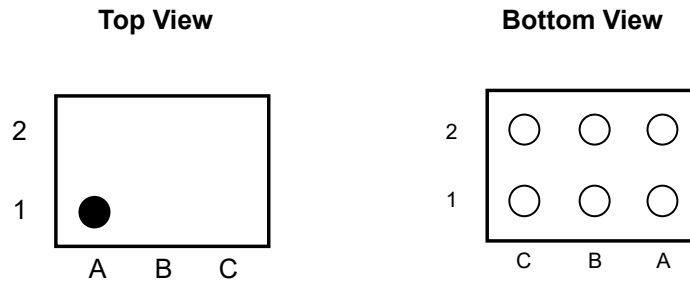

WLCSP-6-P11 Pin Configuration

RP120Z(WLCSP-6-P11) Pin Description

Symbol	Pin No.	I/O	Description
VOUT	A1	O	Output voltage pin. The VOUT pin supplies power to the load. A minimum output capacitance shown in “Phase Compensation” section is required to ensure stability. See the “Phase Compensation” section for more information on output capacitance.
VFB	B1	I	Output Feedback Pin For the type that fixes the output voltage internally, connect this pin to the VOUT pin. For the type that sets the output voltage externally, connect this pin to a resistor divider from VOUT pin to GND.
GND	C1	-	Ground pin of the internal circuit.
VIN	A2	I	Power supply pin of the NMOS driver. Input Supply Voltage. Output load current is supplied directly from VIN. The VIN pin should be locally bypassed to GND.
CE	B2	I	Chip Enable Pin. Logic "High" input : LDO is active, Logic "Low" input: the LDO into shutdown. This pin is pulled down internally.
VBIAS	C2	I	Analog Power Supply Pin Must be connected to an external supply voltage. The VBIAS pin should be locally bypassed to GND.

Please refer to “TYPICAL APPLICATION CIRCUITN” or “OPERATION” for details.

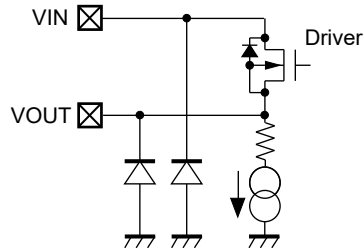
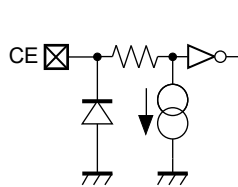
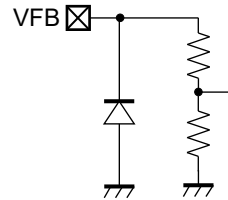
Internal Equivalent Circuit Diagram of Pin**Internal equivalent circuit diagram of VIN and VOUT pin****Internal equivalent circuit diagram of CE pin****Internal equivalent circuit diagram of VFB pin**

ABSOLUTE MAXIMUM RATINGS

ABSOLUTE MAXIMUM RATINGS

Symbol	Item	Ratings	Unit
V _{BIAS}	Analog Power Supply Voltage	-0.3 to 6.5	V
V _{IN}	NMOS driver power input voltage	-0.3 to V _{BIAS} + 0.3 ≤ 6.5	V
V _{CE}	Input Voltage (CE pin)	-0.3 to 6.5	V
V _{OUT}	Output Voltage	-0.3 to V _{IN} + 0.3 ≤ 6.5	V
V _{FB}	VFB pin Voltage	-0.3 to V _{OUT} + 0.3 ≤ 6.5	V
T _j	Junction Temperature Range ^{*1}	-40 to 125	°C
T _{stg}	Storage Temperature Range	-55 to 125	°C

ABSOLUTE MAXIMUM RATINGS

Electronic and mechanical stress momentarily exceeded absolute maximum ratings may cause permanent damage and may degrade the lifetime and safety for both device and system using the device in the field. The functional operation at or over these absolute maximum ratings are not assured.

^{*1} Calculate the power loss of the IC from the usage conditions, and calculate the junction temperature using it and the thermal resistance. Please refer to "Thermal characteristics" for thermal resistance and thermal parameters under our measurement board conditions.

ELECTROSTATIC DISCHARGE(ESD) RATINGS

Symbol	Conditions	Ratings	Unit
V_{HBM}	HBM C=100pF、R=1.5kΩ	±2000	V
V_{CDM}	CDM	±1000	

Electrostatic Discharge Ratings

The electrostatic discharge test is done based on JESD47.
 In the HBM method, ESD is applied using the power supply pin and GND pin as reference pins.

RECOMMENDED OPERATING CONDITIONS

RECOMMENDED OPERATING CONDITIONS

Symbol	Item	Ratings	Unit
V_{BIAS}	Input Voltage	2.4 to 5.5 ($V_{SET} < 0.9$)	V
		$V_{SET} + 1.5V$ to 5.5 ($V_{SET} \geq 0.9$)	
V_{IN}		$V_{SET} + V_{DIF}$ to V_{BIAS} (Max. 5.5)	V
T_a	Operating Temperature Range	-40 to 85	°C

RECOMMENDED OPERATING CONDITIONS

All of electronic equipment should be designed that the mounted semiconductor devices operate within the recommended operating conditions. The semiconductor devices cannot operate normally over the recommended operating conditions, even if they are used over such ratings by momentary electronic noise or surge. And the semiconductor devices may receive serious damage when they continue to operate over the recommended operating conditions.

ELECTRICAL CHARACTERISTICS

$V_{BIAS} = V_{CE} = 3.6\text{ V}$, $V_{IN} = V_{SET} + 0.5\text{ V}$, $I_{OUT} = 1\text{ mA}$, $C_{BIAS} = C_{IN} = 1.0\text{ }\mu\text{F}$, $C_{OUT} = 4.7\text{ }\mu\text{F}$
unless otherwise specified.

The specifications surrounded by are guaranteed by design engineering at $-40^{\circ}\text{C} \leq T_a \leq 85^{\circ}\text{C}$.

RP120xxx1D

($T_a = 25^{\circ}\text{C}$)

Symbol	Parameter	Conditions	Min.	Typ.	Max.	Unit	
V_{OUT}	Output Voltage	$T_a = 25^{\circ}\text{C}$	$V_{SET} > 1.2\text{V}$	x 0.993		x 1.007	V
			$V_{SET} \leq 1.2\text{V}$	- 0.009		+ 0.009	
		$-40^{\circ}\text{C} \leq T_a \leq 85^{\circ}\text{C}$	$V_{SET} > 1.2\text{V}$	x 0.985		x 1.015	
			$V_{SET} \leq 1.2\text{V}$	- 0.018		+ 0.018	
I_{BIAS}	VBIAS Pin Supply Current	$I_{OUT} = 0\text{mA}$		35	50	μA	
I_{IN}	VIN Pin Supply Current	$I_{OUT} = 0\text{mA}$		1.5	2.8	μA	
I_{STBB}	VBIAS pin Standby Current	$V_{BIAS} = 5.5\text{V}$, $V_{CE} = 0\text{V}$		0	0.2	μA	
I_{STBI}	VIN pin Standby Current	$V_{BIAS} = 5.5\text{V}$, $V_{CE} = 0\text{V}$		0	0.2	μA	
I_{CEH}	CE Pin Input Current "H"	$V_{BIAS} = V_{CE} = 5.5\text{ V}$	0.05	0.25	0.6	μA	
$\frac{\Delta V_{OUT}}{\Delta I_{OUT}}$	Load Regulation	$1\text{mA} \leq I_{OUT} \leq 1.5\text{A}$	-1.7	0.1	1.7	%	
$\frac{\Delta V_{OUT}}{\Delta V_{IN}}$	VIN Line Regulation	$V_{SET} + 0.1\text{V} \leq V_{IN} \leq 3.6\text{V}$	-0.25		0.25	%/V	
$\frac{\Delta V_{OUT}}{\Delta V_{BIAS}}$	VBIAS Line Regulation	$V_{SET} + 1.5\text{V} \leq V_{BIAS} \leq 5.5\text{V}$	-0.25		0.25	%/V	
R_{DISTR}	Auto-discharge NMOS On-resistance	$V_{BIAS} = 3.6\text{V}$, $V_{CE} = 0\text{V}$		50		Ω	
V_{CEH}	CE Pin Input Voltage "H"		0.9		5.5	V	
V_{CEL}	CE Pin Input Voltage "L"		0		0.4	V	
V_{DIF}	Dropout Voltage	$V_{BIAS} = 3.3\text{V}$ ($V_{SET} \leq 1.8\text{V}$) $V_{BIAS} = V_{SET} + 1.5\text{V}$ ($1.8\text{V} < V_{SET}$)	Refer to the "PRODUCT-SPECIFIC ELECTRICAL CHARACTERISTICS"			V	
t_{SS}	Soft Start Time ⁽¹⁾		100	185	320	μs	
I_{SC}	Short-circuit Current	$V_{OUT} = 0\text{V}$		0.6		A	
$I_{LIMRISE}$	Limit Current at Start-up	$V_{OUT} = 0\text{V}$		0.6		A	
V_{UVLOF}	UVLO Detection Voltage	$V_{BIAS} = V_{CE} = 3.6\text{V}$, V_{IN} Falling	0.26	0.3	0.34	V	
V_{UVLOR}	UVLO Release Voltage	$V_{BIAS} = V_{CE} = 3.6\text{V}$, V_{IN} Rising	0.36	0.4	0.44	V	

All products are tested under the condition of $T_j \approx T_a = 25^{\circ}\text{C}$.

⁽¹⁾ It is specified based on the measurement result of the time when the V_{OUT} pin voltage rises from 10% to 90%, and converted it to 100% time by calculation.

$V_{BIAS} = V_{CE} = 3.6V$, $V_{IN} = 1.1V$, $I_{OUT} = 1mA$, $C_{BIAS} = C_{IN} = 1.0\mu F$, $C_{OUT} = 4.7\mu F$ unless otherwise specified.

The specifications surrounded by are guaranteed by design engineering at $-40^{\circ}C \leq T_a \leq 85^{\circ}C$.

RP120x001D

(Ta = 25°C)

Symbol	Parameter	Conditions	Min.	Typ.	Max.	Unit
V_{FB}	Feedback pin Output Voltage	Ta = 25°C	0.591	0.6	0.609	V
		$-40^{\circ}C \leq T_a \leq 85^{\circ}C$	0.582	0.6	0.618	
I_{BIAS}	VBIAS Pin Supply Current	$I_{OUT} = 0mA$		35	50	μA
I_{IN}	VIN Pin Supply Current	$I_{OUT} = 0mA$		1.5	2.8	μA
I_{STBB}	VBIAS pin Standby Current	$V_{BIAS} = 5.5V$, $V_{CE} = 0V$		0	0.2	μA
I_{STBI}	VIN pin Standby Current	$V_{BIAS} = 5.5V$, $V_{CE} = 0V$		0	0.2	μA
I_{CEH}	CE Pin Input Current "H"	$V_{BIAS} = V_{CE} = 5.5V$	0.05	0.25	0.6	μA
$\Delta V_{OUT} / \Delta I_{OUT}$	Load Regulation	$1mA \leq I_{OUT} \leq 1.5A$	-1.7	0.1	1.7	%
$\Delta V_{OUT} / \Delta V_{IN}$	VIN Line Regulation	$V_{SET} + 0.1V \leq V_{IN} \leq 3.6V$	-0.25		0.25	%/V
$\Delta V_{OUT} / \Delta V_{BIAS}$	VBIAS Line Regulation	$V_{SET} + 1.5V \leq V_{BIAS} \leq 5.5V$	-0.25		0.25	%/V
R_{DISTR}	Auto-discharge NMOS On-resistance	$V_{CE} = 0V$		50		Ω
V_{CEH}	CE Pin Input Voltage "H"		0.9		5.5	V
V_{CEL}	CE Pin Input Voltage "L"		0		0.4	V
V_{DIF}	Dropout Voltage	$V_{SET} = 0.6V$, $V_{BIAS} = 3.3V$	$I_{OUT} = 1.0A$	0.067	0.115	V
			$I_{OUT} = 1.5A$	0.102	0.168	
t_{SS}	Soft Start Time ⁽¹⁾		100	185	320	μs
I_{SC}	Short-circuit Current	$V_{OUT} = 0V$		0.6		A
$I_{LIMRISE}$	Limit Current at Start-up	$V_{OUT} = 0V$		0.6		A
V_{UVLOF}	UVLO Detection Voltage	$V_{BIAS} = V_{CE} = 3.6V$, V_{IN} Falling	0.26	0.3	0.34	V
V_{UVLOR}	UVLO Release Voltage	$V_{BIAS} = V_{CE} = 3.6V$, V_{IN} Rising	0.36	0.4	0.44	V

All test items listed under Electrical Characteristics are done with short-circuiting VOUT pin and VFB pin, and under the pulse load condition ($T_j \approx T_a = 25^{\circ}C$).

⁽¹⁾ It is specified based on the measurement result of the time when the VOUT pin voltage rises from 10% to 90%, and converted it to 100% time by calculation.

The specifications surrounded by are guaranteed by design engineering at $-40^{\circ}\text{C} \leq T_a \leq 85^{\circ}\text{C}$

RP120Zxx1D Product-specific Electrical Characteristics

Product Name	V_{OUT} [V]					V_{DIF} [mV]			
	Typ.	$T_a = 25^{\circ}\text{C}$		$-40^{\circ}\text{C} \leq T_a \leq 85^{\circ}\text{C}$		$I_{\text{OUT}}=1.0\text{A}$		$I_{\text{OUT}}=1.5\text{A}$	
		Min.	Max.	Min.	Max.	Typ.	Max.	Typ.	Max.
RP120Z061D	0.6	0.591	0.609	0.582	0.618	67	115	102	168
RP120Z071D	0.7	0.691	0.709	0.682	0.718	68	117	104	171
RP120Z071D5	0.75	0.741	0.759	0.732	0.768	69	121	107	175
RP120Z081D	0.8	0.791	0.809	0.782	0.818	69	121	107	175
RP120Z091D	0.9	0.891	0.909	0.882	0.918	72	127	110	178
RP120Z101D	1.0	0.991	1.009	0.982	1.018	73	131	113	185
RP120Z111D	1.1	1.091	1.109	1.082	1.118	76	138	117	194
RP120Z121D	1.2	1.191	1.209	1.182	1.218	80	146	122	202
RP120Z131D	1.3	1.291	1.309	1.281	1.319	84	153	131	218
RP120Z141D	1.4	1.391	1.409	1.379	1.421	89	163	140	239
RP120Z151D	1.5	1.490	1.510	1.478	1.522	97	176	155	268
RP120Z161D	1.6	1.589	1.611	1.576	1.624	104	187	170	302
RP120Z171D	1.7	1.689	1.711	1.675	1.725	113	204	183	332
RP120Z181D	1.8	1.788	1.812	1.773	1.827	123	225	193	368
RP120Z191D	1.9	1.887	1.913	1.872	1.928	123	225	193	368
RP120Z201D	2.0	1.986	2.014	1.970	2.030	123	225	193	368

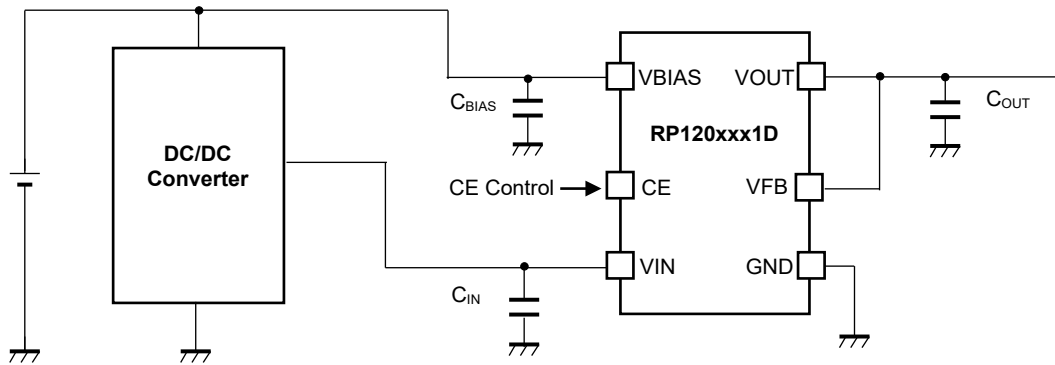
TYPICAL APPLICATION CIRCUIT

RP120xxx1D (Internal Fixed Type) Typical Application Circuit

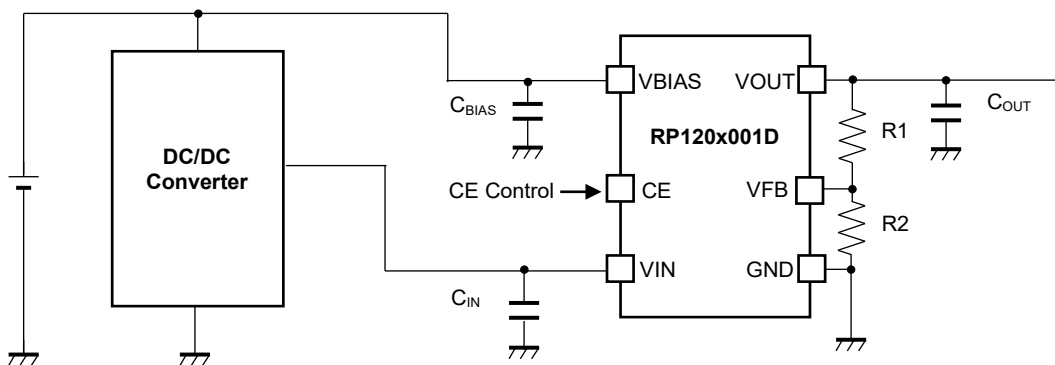

RP120x001D (Adjustable Output Type) Typical Application Circuit

External Components

VIN, VBIAS pins should be locally bypassed to GND to make their impedance low. If their impedance is high, making unexpected noise or unstable operation may result. A capacitor (C_{BIAS}) between VBIAS pin and GND and another capacitor (C_{IN}) between VIN pin and GND should be 1 μ F or more each.

It is desirable to choose X7R and X5R ceramic capacitors (voltage rating should be more than twice as much as input), which have good temperature characteristics of ESR, ESL, and capacitance.

Phase Compensation

The RP120 is designed to be stable with an output capacitor for phase compensation with whole range of the output load current. An output capacitor of minimum 4.7 μ F ($V_{SET} \leq 2.0V$), or minimum 10 μ F ($V_{SET} > 2.0V$) or greater value of C_{OUT} is recommended to ensure stability. Note that bypass capacitors used to decouple individual components powered by the more stable characteristics and are more suitable for use as the output capacitor.

It is desirable to choose X7R and X5R ceramic capacitor for output capacitor. The X7R type has better stability across temperature, while the X5R is less expensive and is available in higher values. Select so that the following effective capacitance can be secured.

Set Output Voltage (V_{SET})	Effective Capacitance
$0.6V \leq V_{SET} < 1.2V$	Min. 2.7 μ F
$1.2V \leq V_{SET} \leq 2.0V$	Min. 2.4 μ F
$2.0V < V_{SET} \leq 3.6V$	Min. 6.0 μ F

External Resistor for Setting Output Voltage

The output voltage is set by the ratio of two external resistors as shown above.

Output Voltage Setting Range : 0.6V to 3.6V
 $V_{FB} = 0.6V$ (Typ.)

The set output voltage (V_{SET}) is as follows.

$$V_{SET} = V_{FB} \times ((R1 + R2) / R2)$$

More precisely, the current in R1 is the current in R2 plus the internal current through the resistance (R_{IC}) between VFB pin and GND. The value of the R_{IC} is Typ.3.6M Ω , therefore, $V_{FB} \times R1/R_{IC}$ makes an error.

If $R1 \ll R_{IC}$, the error can be reduced.

Use a resistance value, R2 of 20k Ω or less for $V_{SET} < 1.3V$ and 10k Ω or less for $V_{SET} \geq 1.3V$.

OPERATION

Chip Enable Function

Input "High" to CE pin, the RP120 is active. Input "Low" to CE pin, the RP120 is into shutdown. Regardless of the state of V_{IN} and V_{BIAS} voltage, a voltage can be forced to CE pin. The CE pin is pulled down inside the IC with a constant current of Typ. $0.25\mu A$, therefore, when the CE pin is left floating, the RP120 goes into shutdown state. CE pin must be tied to a valid logic level (such as V_{BIAS}) if not used.

UVLO (Undervoltage Lock Out) Function

An undervoltage lockout comparator (UVLO) is activated while CE pin is "High". The UVLO comparator senses V_{IN} pin voltage to ensure that the V_{IN} supply for the LDO is greater than UVLO released voltage (V_{UVLOR} , Typ. 0.4V) before enabling the LDO. If V_{IN} is below the UVLO threshold (V_{UVLOF} , Typ. 0.3V), the UVLO shuts down the LDO, and V_{OUT} is pulled to GND through the external divider and internal auto discharge transistor for Off state. After UVLO is released, the LDO starts up with soft-start.

Thermal Shutdown Function

The RP120 has internal thermal limiting designed to protect the device during momentary overload conditions. For continuous normal conditions, the maximum junction temperature rating of $125^{\circ}C$ must not be exceeded. At higher temperatures, or in cases where internal power dissipation cause excessive self-heating on-chip, the thermal shutdown circuitry will shut down LDO when the junction temperature exceeds Typ. $165^{\circ}C$, the RP120 will reenables once the junction temperature drops back to thermal shutdown released threshold (Typ. $125^{\circ}C$), the IC will restart with the soft start operation.

Auto Discharge

When turning off, the V_{OUT} voltage quickly pulled down to near 0V by discharging electric charge stored in output capacitor through the MOSFET connected between the V_{OUT} pin and GND. The auto discharge function is enabled when CE pin = "Low", thermal shutdown detection, or UVLO detection. This function is effective when V_{BIAS} is the minimum operating voltage or higher. The on-resistance of the MOSFET is Typ. 50Ω .

Soft Start / Inrush Current Limit

The RP120 includes a soft-start feature to prevent excessive inrush current flow at V_{IN} during start-up. When the LDO is enabled, the soft-start circuitry gradually increases the internal reference voltage of LDO over a period of approximately 185 μ s.

In addition, the RP120 limits the inrush current up to Typ. 600mA during startup.

The inrush current depends on the capacitance value of C_{OUT} . Connecting a large load and the inrush current value may exceed the threshold of Typ. 600mA during startup, the slew rate is further limited and extended start-up time. If an effective capacitance value of the C_{OUT} is larger than about $110\mu\text{F} / V_{SET}$ is used, the output voltage ramp up time is determined by the inrush current limit value and C_{OUT} value.

The output turning on time (t_{ON}) can be calculated from the following equation:

$$t_{ON} = t_D + C_{OUT} \times V_{SET} / I_{LIMRISE}$$

t_D : Delay Time at Start-up 60 μ s

V_{SET} : Set Output Voltage

$I_{LIMRISE}$: Current Limit at Start-up Typ. 600mA

If the load current (I_{LOAD}) exists other than the charge current to C_{OUT} during start-up, the start-up time is extended. The load current over $I_{LIMRISE}$ may interfere charging of C_{OUT} and the output does not rise up.

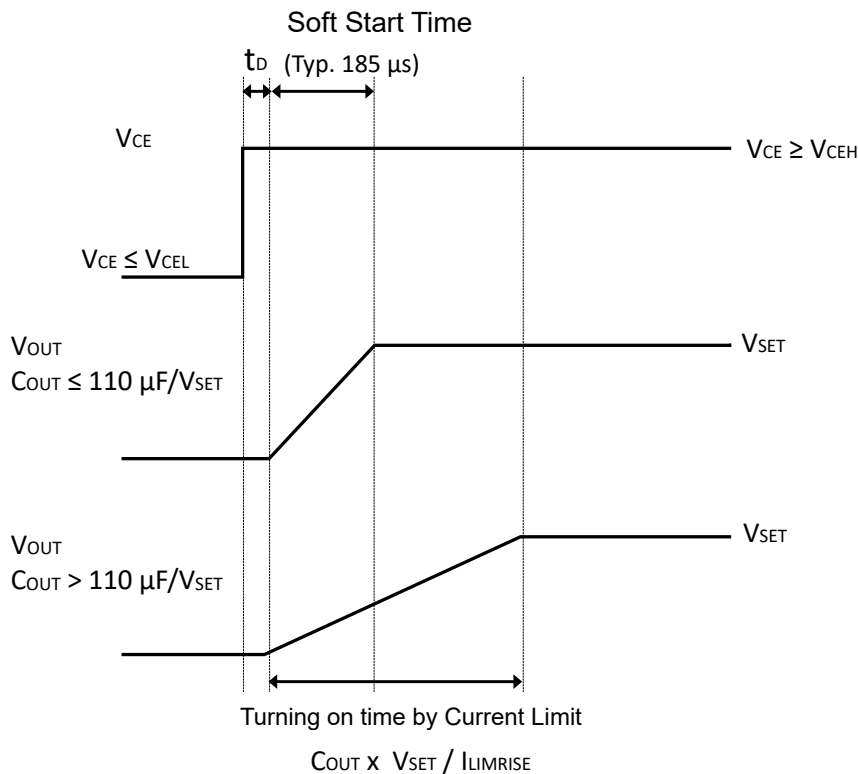

Thermal Characteristics 1

The power dissipation of the package is dependent on PCB material, layout, and environmental conditions. The following measurement conditions are based on JEDEC STD. 51

Item	Measurement Result
Thermal Resistance (θ_{ja})	$\theta_{ja} = 170^{\circ}\text{C/W}$
Thermal Parameters (ψ_{jt})	$\psi_{jt} = 41.7^{\circ}\text{C/W}$

θ_{ja} : Junction-to-Ambient Thermal Resistance.

ψ_{jt} : Thermal parameters between junction temperature and package mark surface center temperature.

Measurement Condition

Measurement Status	Board Mounting State (Wind speed = 0m/s)
Board Material	Glass Epoxy Resin (4-layer board)
Board Size	76.2mm x 114.3mm x 1.6mm
Wiring Rate	Outer Layer (1-Layer): 10% or less Inner Layers (2 and 3-Layers): 74.2 x 74.2mm 100% Outer Layer (4-Layer): 10% or less

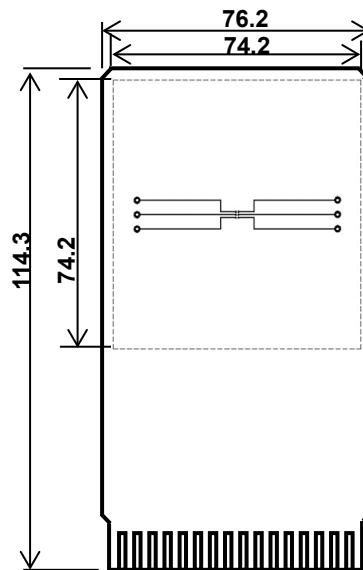

Measurement Board Pattern

Thermal Characteristics 2

Thermal characteristics depend on the mounting conditions.
The following thermal characteristics are measurement data using our evaluation board.

Item	Measurement Result
Thermal Resistance (θ_{ja})	$\theta_{ja} = 80^{\circ}\text{C/W}$
Thermal Parameters (ψ_{jt})	$\psi_{jt} = 17.1^{\circ}\text{C/W}$

θ_{ja} : Junction-to-Ambient Thermal Resistance.

ψ_{jt} : Thermal parameters between junction temperature and package mark surface center temperature.

Measurement Condition

Measurement Status	Board Mounting State (Wind Speed 0m/s)
Board Material	Glass Epoxy Resin (4-Layer Board)
Board Size	30mm × 30mm × 1.0mm
Wiring Rate	Outer Layer (1-Layer): 85% Inner Layers (2 and 3-Layers): 85% Outer Layer (4-Layer): 85%

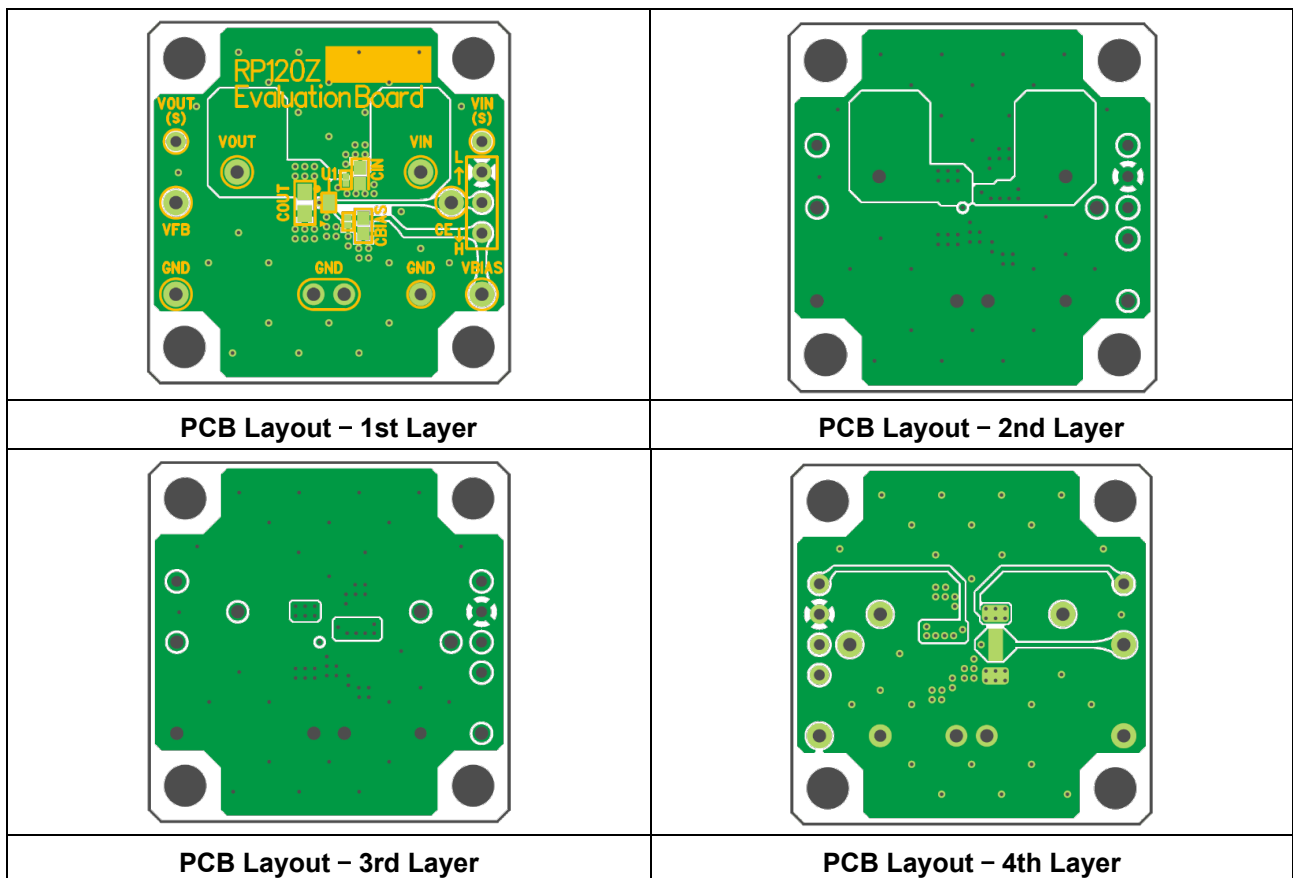

Calculation Method of Junction Temperature Using Thermal Characteristics

The junction temperature (T_j) inside the IC can be calculated from the thermal characteristics using the following formula.

$$T_j = T_a + \theta_{ja} \times P$$

$$T_j = T_c(\text{top}) + \psi_{jt} \times P$$

T_a : Ambient temperature

$T_c(\text{top})$: Package mark surface center temperature

P : $(V_{IN} - V_{OUT}) \times I_{OUT}$ (Power consumption under customer's usage conditions)

TECHNICAL NOTES

Constraints of the voltage value and the sequence of V_{BIAS} and V_{IN}

V_{IN} voltage must be applied below V_{BIAS} voltage since a forward current flows through the parasitic diode in the IC. $V_{BIAS} \geq V_{IN}$ should be true even when they turn on and off. At startup, supply V_{IN} and V_{BIAS} at the same time, or supply V_{IN} after V_{BIAS} . When turning off the supply voltage of V_{IN} and V_{BIAS} , turn them off at the same time, or turn off V_{IN} before V_{BIAS} .

Thermal Shutdown

The thermal shutdown function prevents the IC from fuming and firing but does not ensure the IC's reliability or keep the IC below the absolute maximum ratings. The thermal shutdown function does not operate against the heat generated by abnormal IC operation such as latch-up and overvoltage.

The thermal shutdown function operates in a state over the absolute maximum ratings, and should not be used for a system design.

APPLICATION INFORMATION

Adjustable Output Voltage

The output voltage is set by the ratio of two external resistors (R1, R2).

The device servos the output to maintain the VFB pin voltage at 0.6V(referenced to ground). The output voltage (V_{SET}) can be calculated using the formula below.

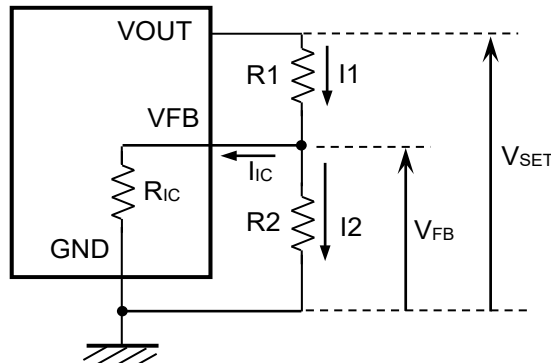

$$I1 = I_{IC} + I2 \dots\dots\dots (1)$$

$$I2 = V_{FB} / R2 \dots\dots\dots (2)$$

(1), (2)

$$I1 = I_{IC} + V_{FB} / R2 \dots\dots\dots (3)$$

$$V_{SET} = V_{FB} + R1 \times I1 \dots\dots\dots (4)$$

I1 can be substituted by formula (3)

$$\begin{aligned} V_{SET} &= V_{FB} + R1 \times (I_{IC} + V_{FB} / R2) \\ &= V_{FB} \times (1 + R1 / R2) + R1 \times I_{IC} \dots\dots\dots (5) \end{aligned}$$

R1 × I_{IC} in the above formula (5) is the error.

$$I_{IC} = V_{FB} / R_{IC} \dots\dots\dots (6)$$

Thus,

$$\begin{aligned} R1 \times I_{IC} &= R1 \times V_{FB} / R_{IC} \\ &= V_{FB} \times R1 / R_{IC} \dots\dots\dots (7) \end{aligned}$$

If R1 << R_{IC}, the error can be minimized.

If the error is ignored, the output voltage is calculated by the next formula.

$$V_{SET} = V_{FB} \times ((R1 + R2) / R2) \dots\dots\dots (8)$$

R_{IC} of RP120Z001D is Typ.3.6MΩ (Ta=25°C, guaranteed by design value).

The accuracy of the output voltage is determined by the V_{FB} accuracy and resistance accuracy.

The current calculated by V_{SET} / (R1 + R2) flows between the VOUT pin and GND.

V_{FB} of RP120Z001D is typically 0.6V.

Recommended output voltage setting range: $0.6V \leq V_{SET} \leq 3.6V$

V_{FB} accuracy: $0.6V \pm 18mV$ (guaranteed by design in all temperature range).

Use a resistance value, R2 of 20k Ω or less for $V_{SET} < 1.3V$ and 10k Ω or less for $V_{SET} \geq 1.3V$.

Reference Resistance Value Table

Set Output Voltage [V]	R1 [k Ω]	R2 [k Ω]
0.6	Short	Open
0.7	3.3	20
0.8	6.6	20
0.9	9.9	20
1.05	14.9	20
1.1	16.5	20
1.2	19.9	20
1.3	11.6	10
1.5	14.9	10
1.8	19.9	10
2.5	31.6	10
2.8	36.5	10
3.0	39.9	10
3.3	44.8	10
3.6	49.8	10

PCB Layout

Internal Fixed Type

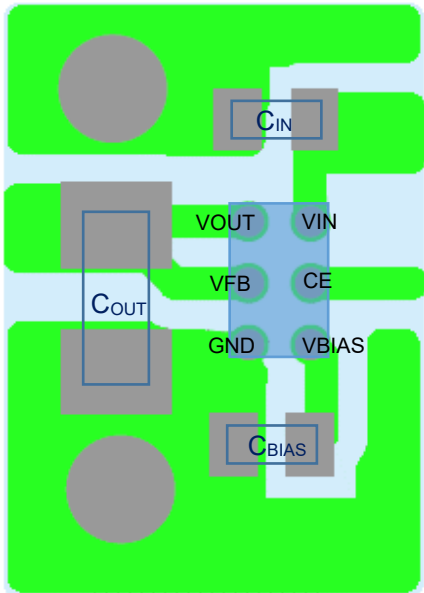

Adjustable Output Type

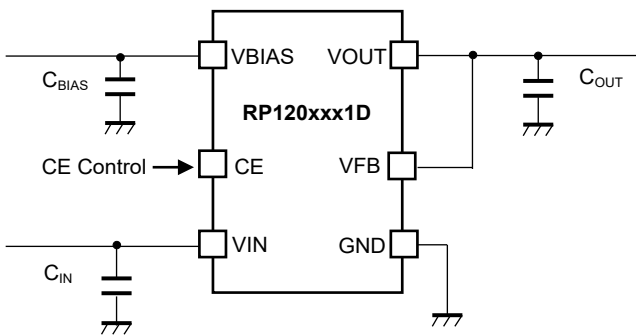
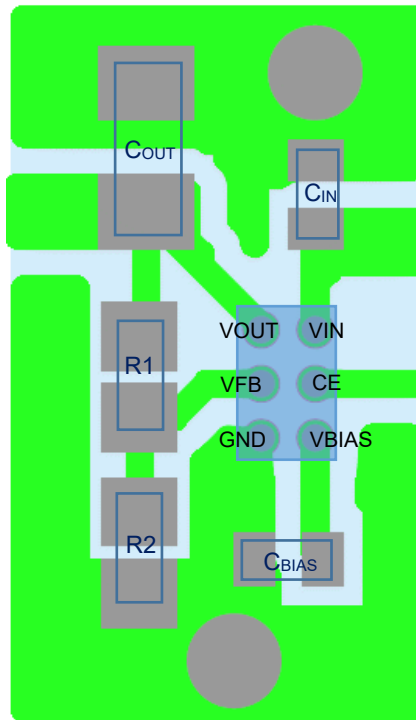

RP120xxx1D (Internal Fixed Type) Circuit

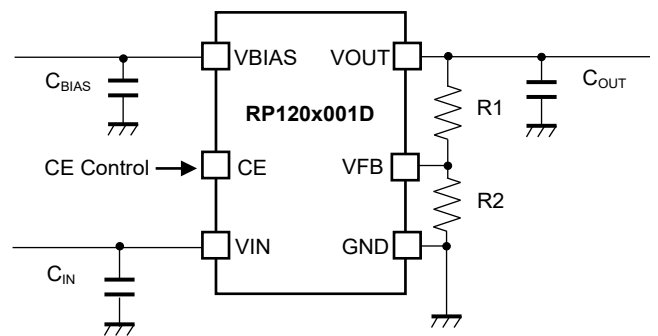

RP120x001D (Adjustable Output Type) Circuit

TYPICAL CHARACTERISTIC

The waveform under the condition $V_{BIAS} < V_{IN}$ describes the characteristics of $V_{IN} = V_{BIAS}$.

Typical Characteristics are intended to be used as reference data, they are not guaranteed.

1) Output Voltage vs. Temperature

$V_{BIAS} = 3.6\text{ V}$, $CE = V_{BIAS}$, $I_{OUT} = 1\text{ mA}$

RP120Z061D, $V_{IN} = 1.1\text{ V}$

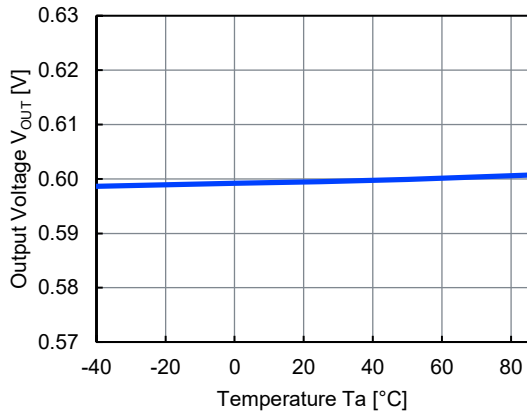

RP120Z121D, $V_{IN} = 1.7\text{ V}$

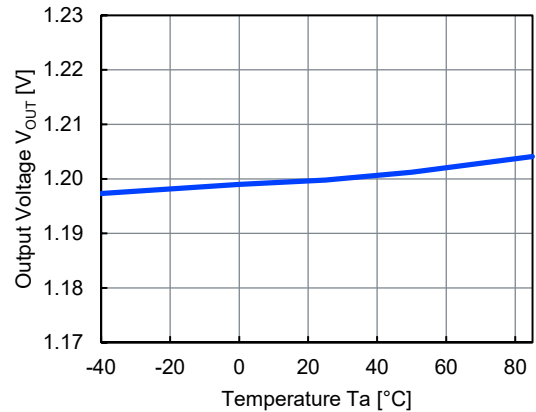

RP120Z201D, $V_{IN} = 2.5\text{ V}$

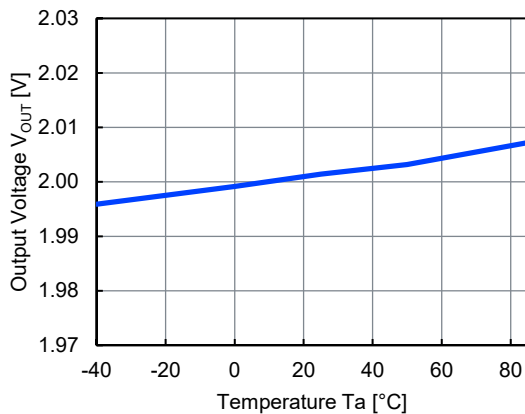

2) VBIAS Supply Current vs. Temperature

$V_{BIAS} = 3.6\text{ V}$, $CE = V_{BIAS}$

RP120Z061D, $V_{IN} = 1.1\text{ V}$

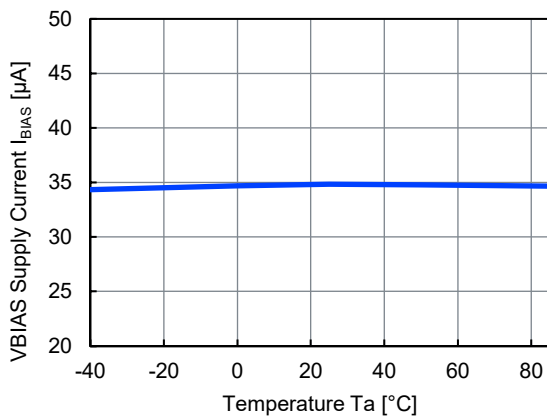

RP120Z121D, $V_{IN} = 1.7\text{ V}$

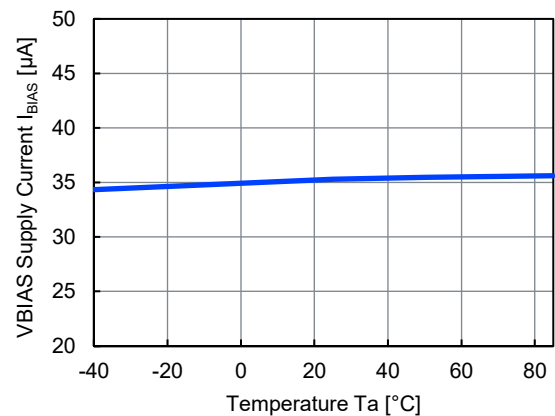

RP120Z201D , $V_{IN} = 2.5\text{ V}$

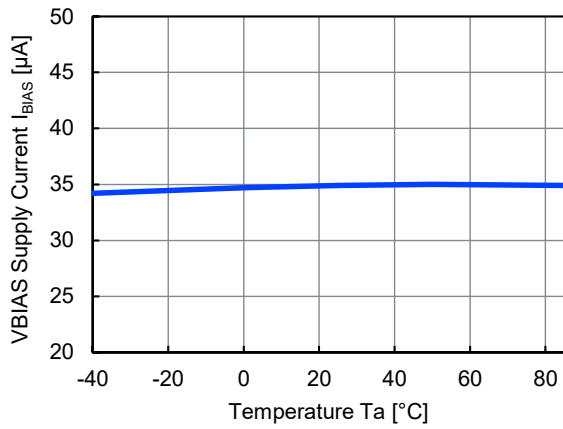

3) VIN pin Supply Current vs. Temperature

$V_{BIAS} = 3.6\text{ V}$, $CE = V_{BIAS}$

RP120Z061D , $V_{IN} = 1.1\text{ V}$

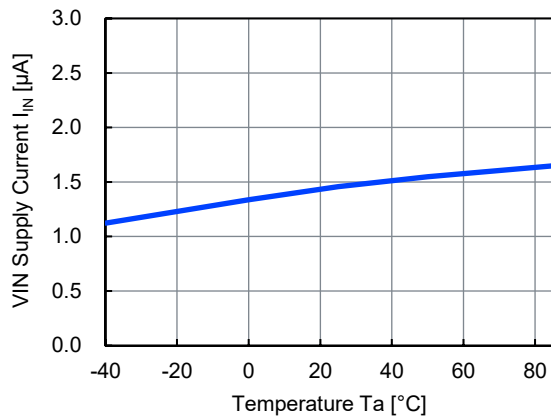

RP120Z121D , $V_{IN} = 1.7\text{ V}$

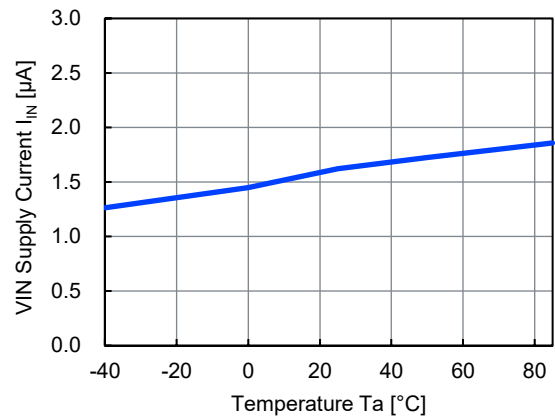

RP120Z201D , $V_{IN} = 2.5\text{ V}$

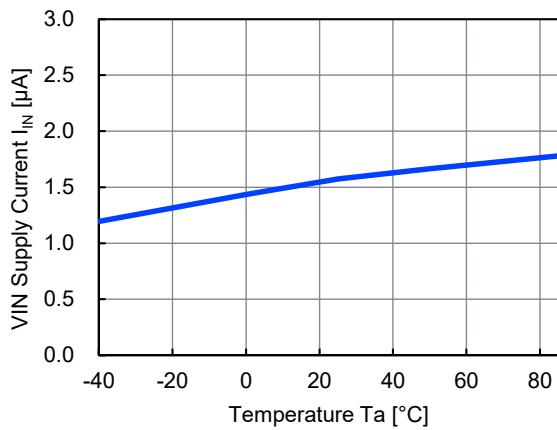

4) VBIAS pin Standby Current vs. Temperature

$V_{BIAS} = 5.5\text{ V}$, $CE = 0\text{ V}$
 RP120Z061D, $V_{IN} = 1.1\text{ V}$

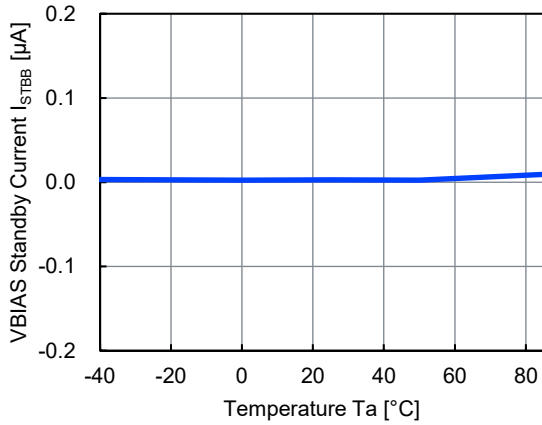

RP120Z121D, $V_{IN} = 1.7\text{ V}$

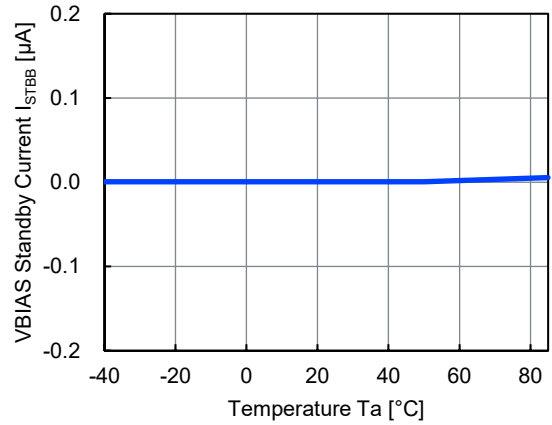

RP120Z201D, $V_{IN} = 2.5\text{ V}$

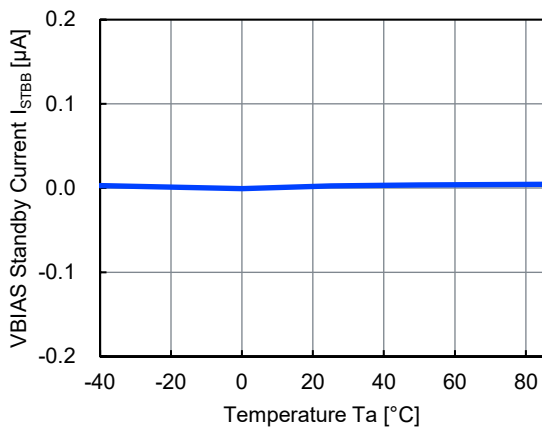

5) VIN pin Standby Current vs. Temperature

$V_{BIAS} = 5.5\text{ V}$, $CE = 0\text{ V}$
 RP120Z061D, $V_{IN} = 1.1\text{ V}$

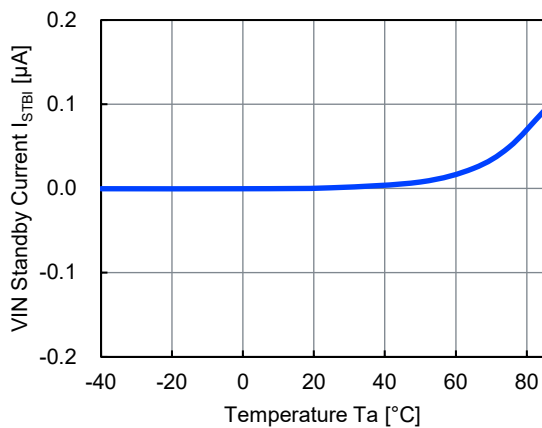

RP120Z121D, $V_{IN} = 1.7\text{ V}$

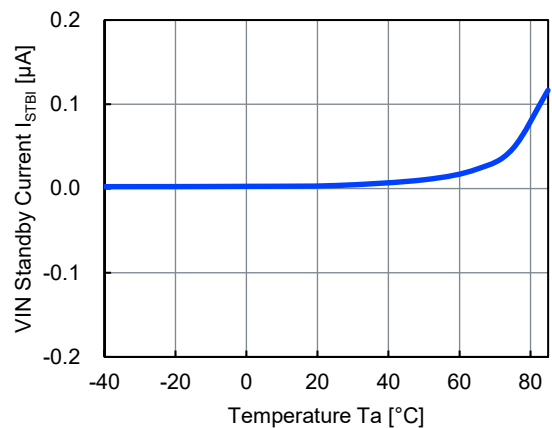

RP120Z201D , $V_{IN} = 2.5\text{ V}$

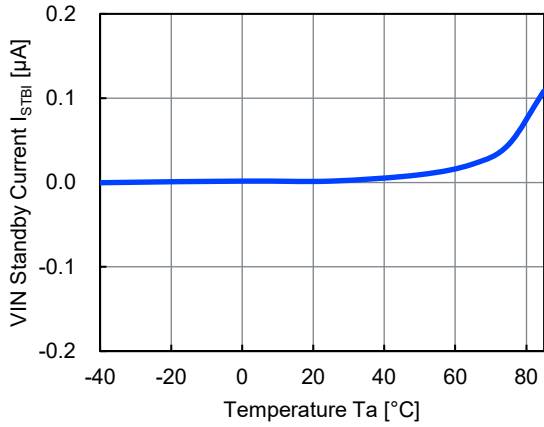

6) Dropout Voltage vs. Output Current

RP120Z121D , $CE = V_{BIAS}$

$V_{BIAS} = 2.7\text{ V}$

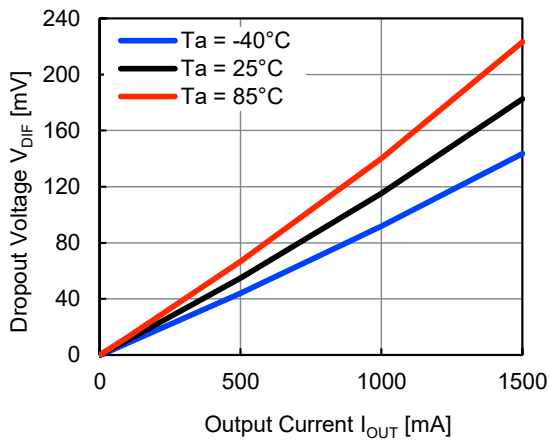

$V_{BIAS} = 3.0\text{ V}$

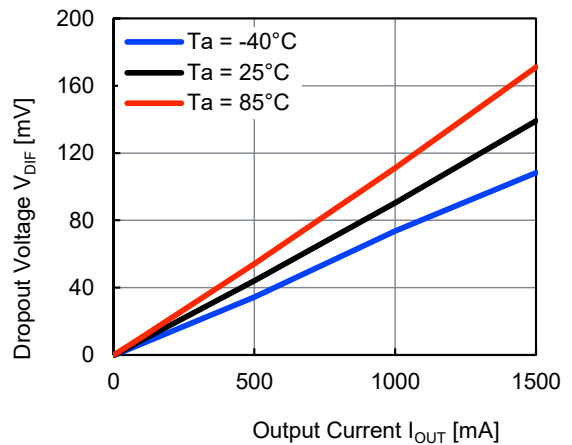

$V_{BIAS} = 3.6\text{ V}$

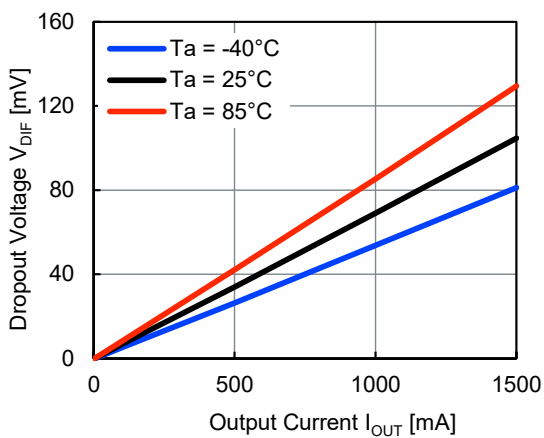

7) Dropout Voltage vs. Temperature

$V_{BIAS} = 3.0\text{ V}$, $CE = V_{BIAS}$
 RP120Z061D

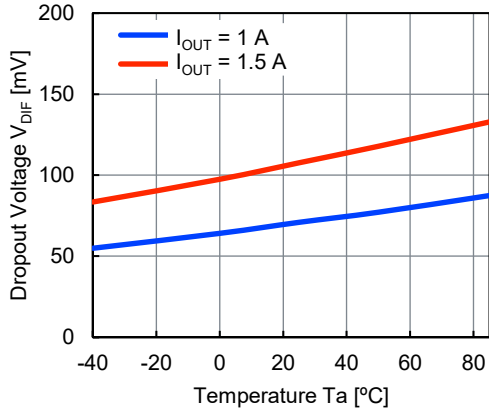

8) Dropout Voltage vs. Driver Drive Voltage ($V_{BIAS} - V_{SET}$)

RP120Z121D , $CE = V_{BIAS}$
 $I_{OUT} = 1.0\text{ A}$

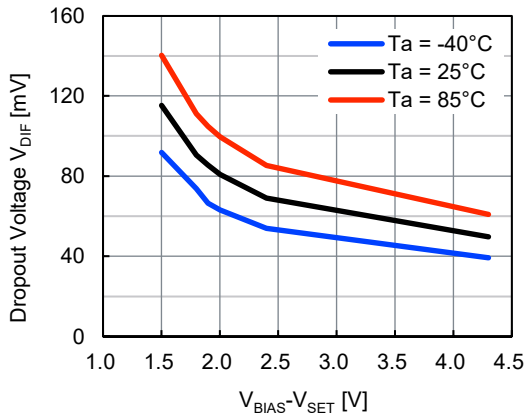

$I_{OUT} = 1.5\text{ A}$

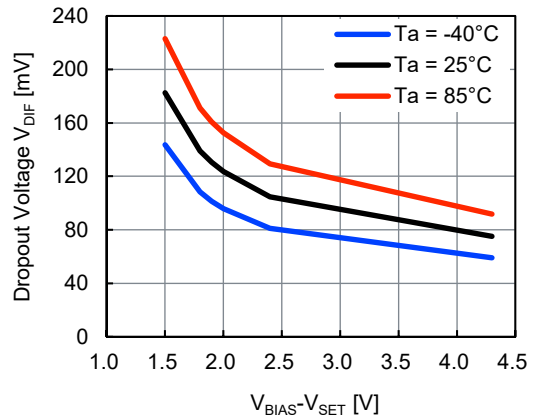

9) Output Voltage vs. VBIAS Input Voltage

$V_{BIAS} = 5.5\text{ to }0\text{ V Sweep}$, $CE = V_{BIAS}$
 RP120Z061D , $V_{IN} = 1.1\text{ V}$

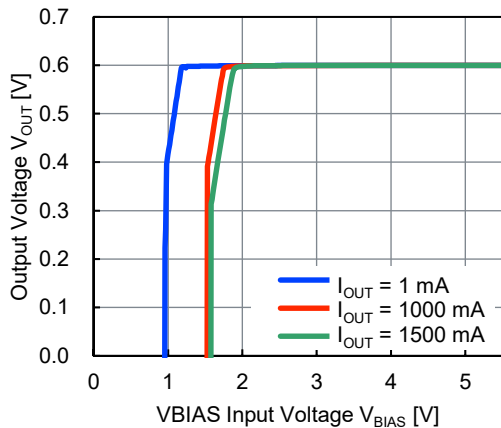

RP120Z121D , $V_{IN} = 1.7\text{ V}$

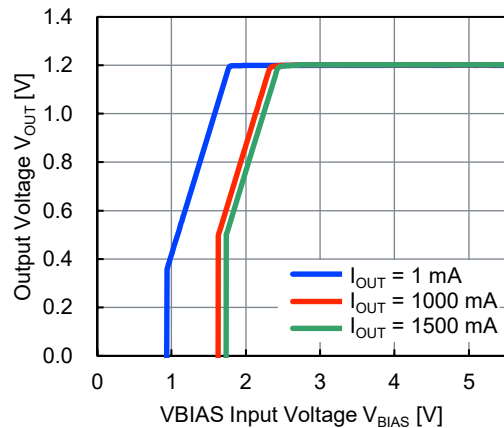

RP120Z201D , $V_{IN} = 2.5V$

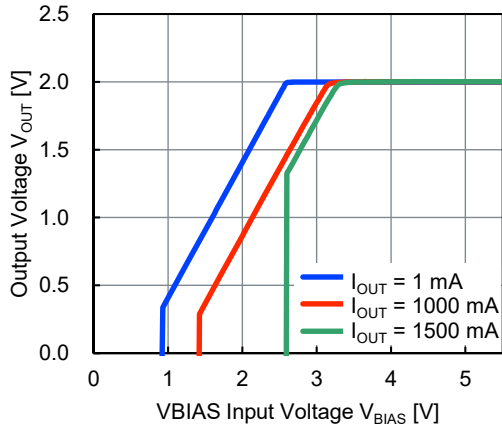

10) Output Voltage vs. V_{IN} Input Voltage

RP120Z061D , $V_{IN} = V_{BIAS}$ to 0 V Sweep , $CE = V_{BIAS}$
 $V_{BIAS} = 2.4 V$

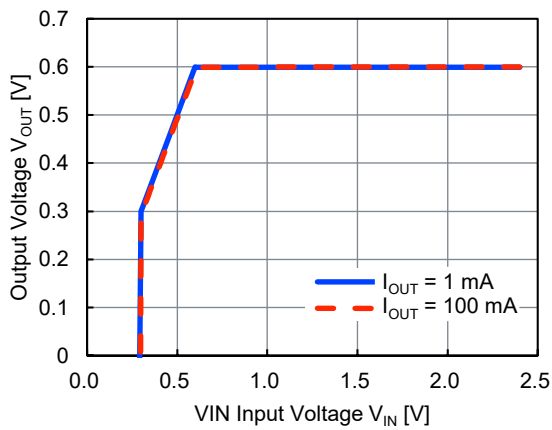

$V_{BIAS} = 3.6 V$

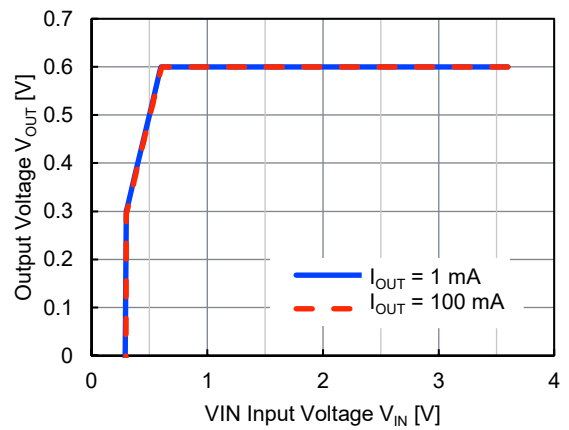

$V_{BIAS} = 5.5 V$

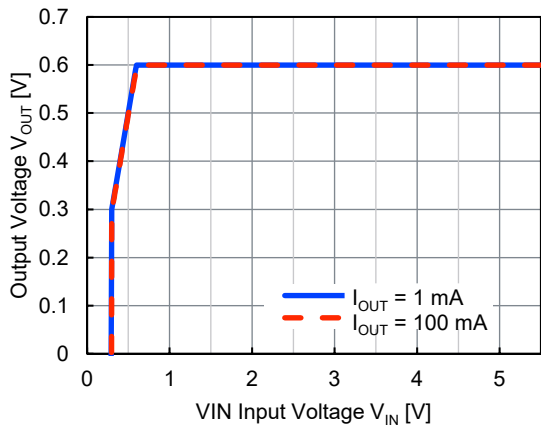

RP120Z121D, $V_{IN} = V_{BIAS}$ to 0 V Sweep, $CE = V_{BIAS}$
 $V_{BIAS} = 2.7$ V

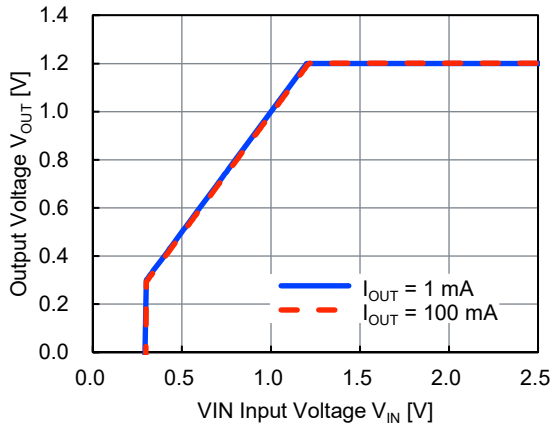

$V_{BIAS} = 3.6$ V

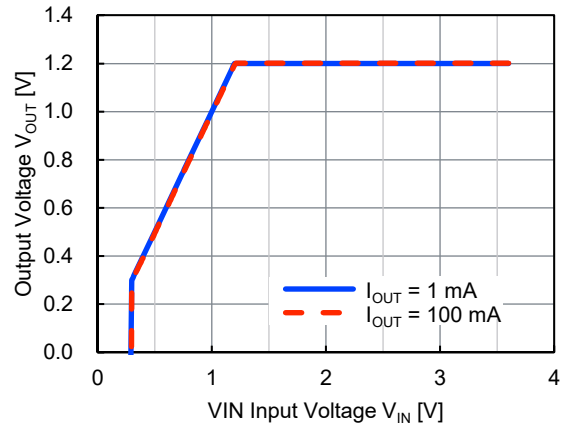

$V_{BIAS} = 5.5$ V

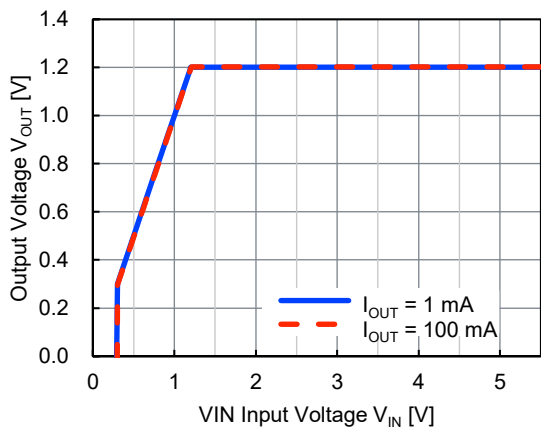

RP120Z201D, $V_{IN} = V_{BIAS}$ to 0 V Sweep, $CE = V_{BIAS}$
 $V_{BIAS} = 3.5$ V

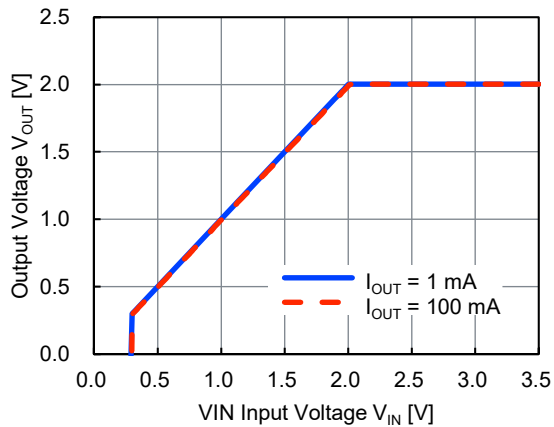

$V_{BIAS} = 5.5$ V

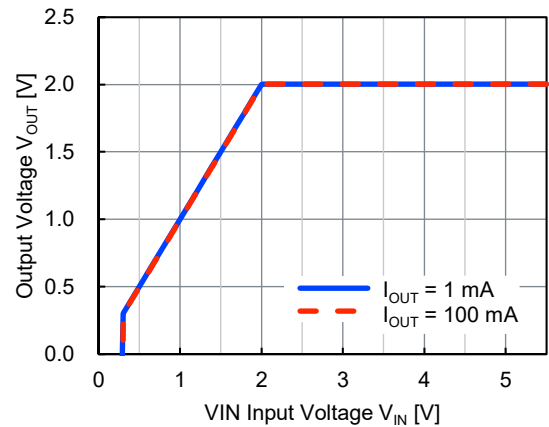

11) VBIAS pin Supply Current vs. VBIAS Input Voltage

$V_{BIAS} = 5.5$ to 0 V Sweep , $CE = V_{BIAS}$

RP120Z061D

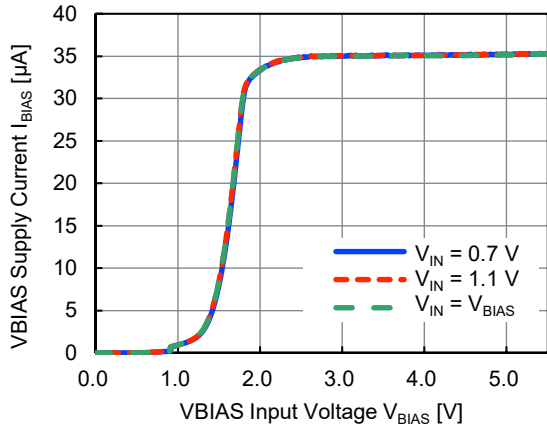

RP120Z121D

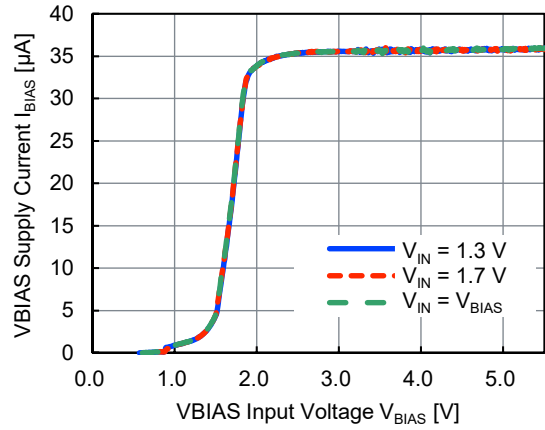

RP120Z201D

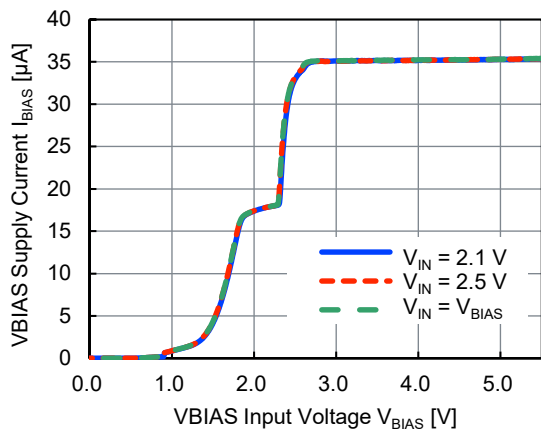

12) Supply Current vs. VIN Input Voltage

RP120Z061D , $V_{BIAS} = 5.5$ V , $V_{IN} = 5.5$ to 0 V Sweep , $CE = V_{BIAS}$

Overall View

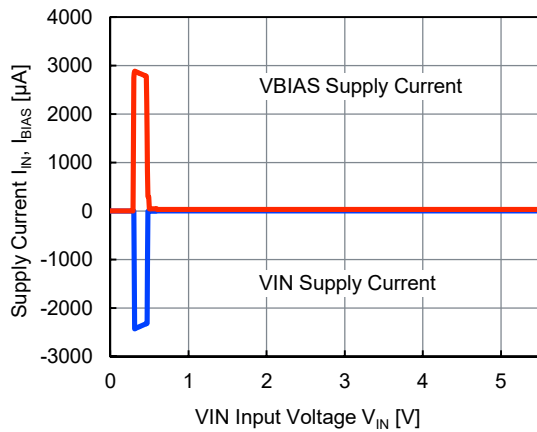

Zoom-in View

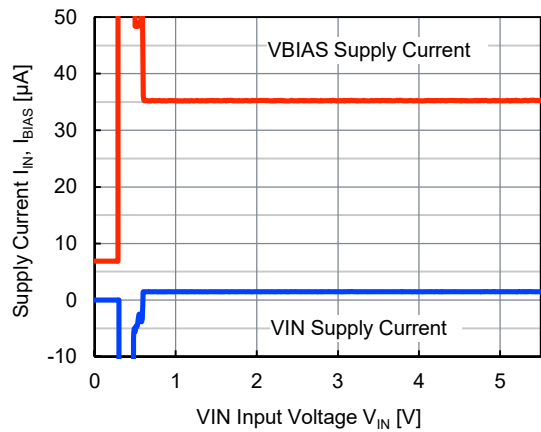

RP120Z121D

Overall View

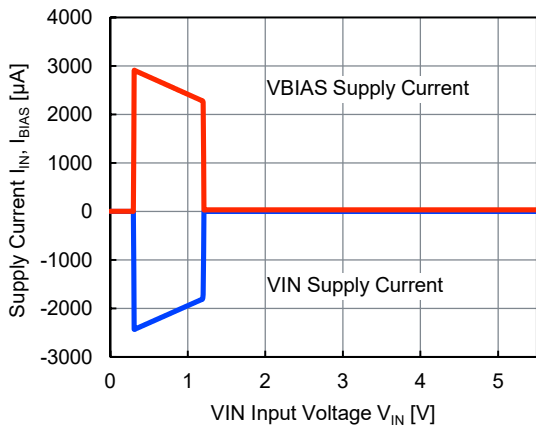

Zoom-in View

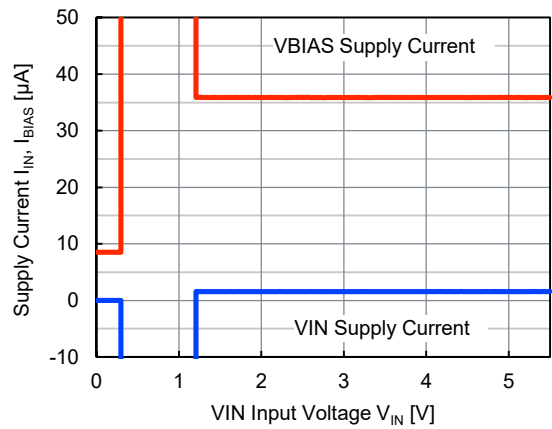

RP120Z201D

Overall View

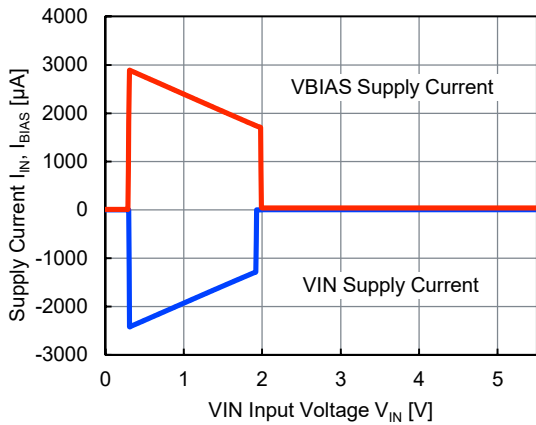

Zoom-in View

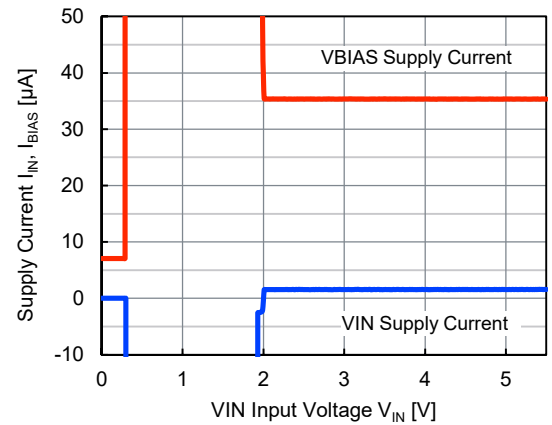

Note that if the input voltage V_{IN} drops below the output set voltage V_{SET} , current will flow from the V_{BIAS} pin to the V_{IN} pin via the inside of the IC. However, it does not flow under the condition that V_{BIAS} decreases at the with V_{IN} .

13) Chip Enable Threshold Voltage vs. Temperature

RP120Z121D, $V_{BIAS} = 3.6$ V, $V_{IN} = 1.7$ V

CE = "High"

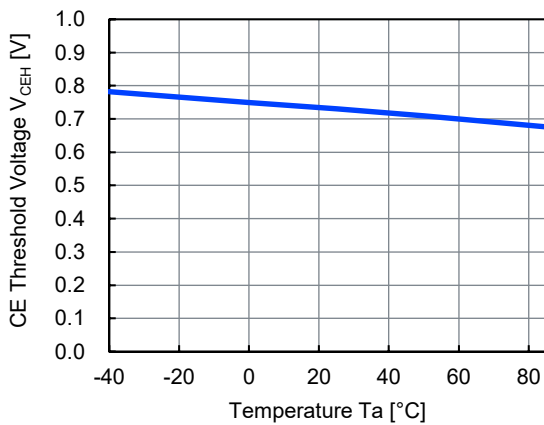

CE = "Low"

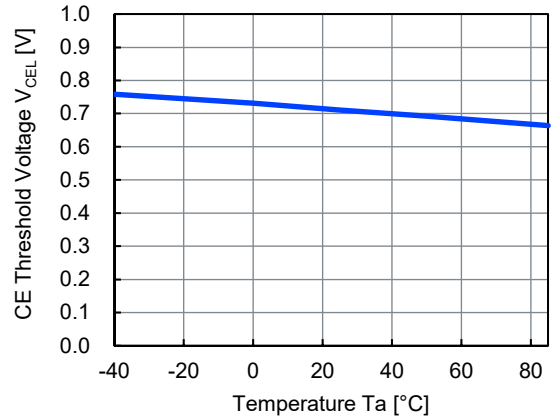

14) VIN Ripple Rejection vs. VIN Input Voltage

RP120Z061D, $V_{BIAS} = 3.6\text{ V}$, $V_{IN} = V_{BIAS}$ to 0.6 V , $V_{ripple} = 0.2\text{V p-p}$, $CE = V_{BIAS}$

$I_{OUT} = 1\text{ mA}$

$I_{OUT} = 100\text{ mA}$

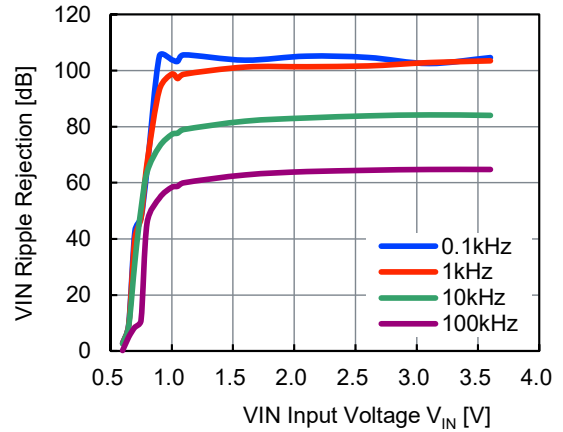
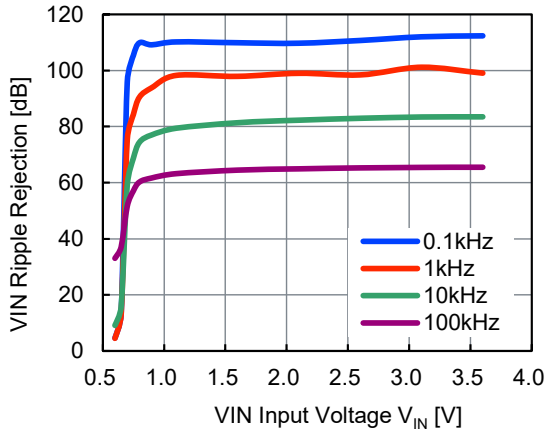

RP120Z121D, $V_{BIAS} = 3.6\text{ V}$, $V_{IN} = V_{BIAS}$ to 1.2 V , $V_{ripple} = 0.2\text{V p-p}$, $CE = V_{BIAS}$

$I_{OUT} = 1\text{ mA}$

$I_{OUT} = 100\text{ mA}$

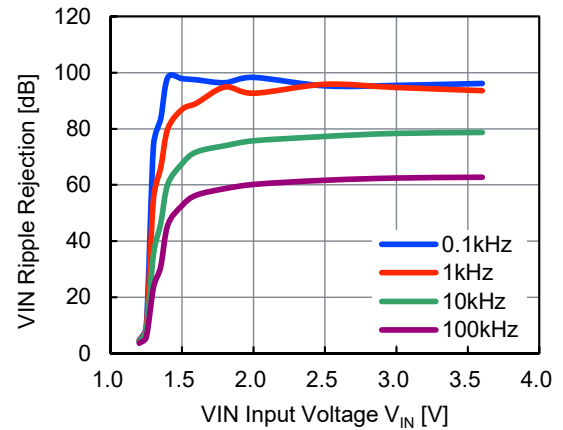
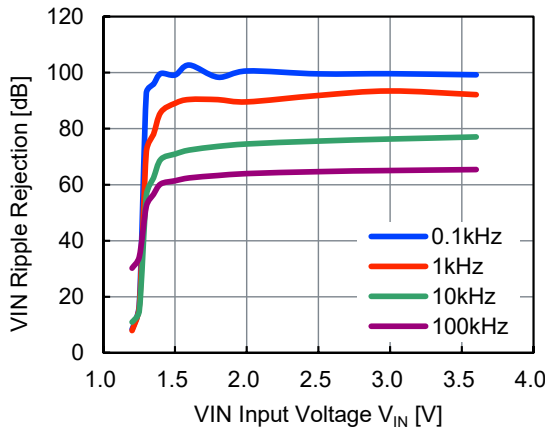

RP120Z201D, $V_{BIAS} = 3.6\text{ V}$, $V_{IN} = V_{BIAS}$ to 2.0 V , $V_{ripple} = 0.2\text{V p-p}$, $CE = V_{BIAS}$

$I_{OUT} = 1\text{ mA}$

$I_{OUT} = 100\text{ mA}$

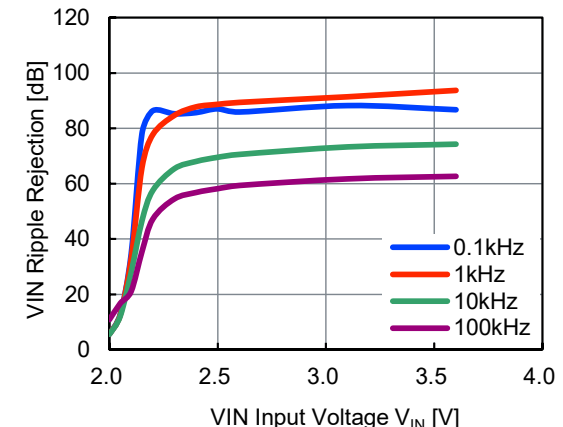
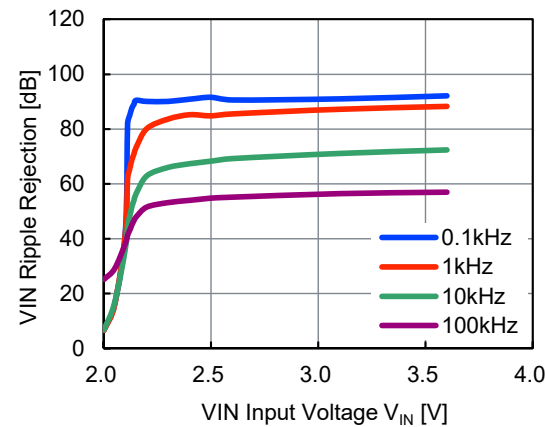

15) VIN Ripple Rejection vs. VBIAS Input Voltage

$V_{IN} = 1.1\text{ V}$, $V_{ripple} = 0.2\text{V p-p}$, $C_E = V_{BIAS}$, $I_{OUT} = 100\text{ mA}$

RP120Z061D

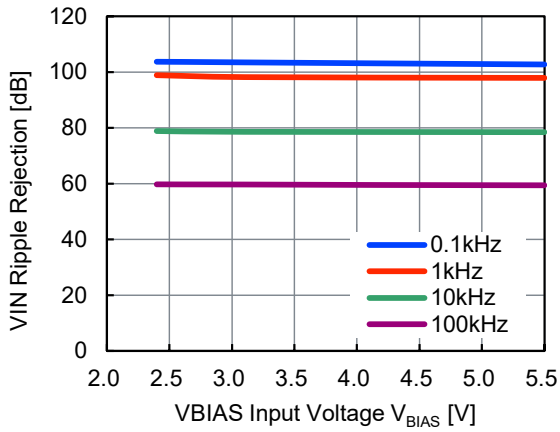

RP120Z121D

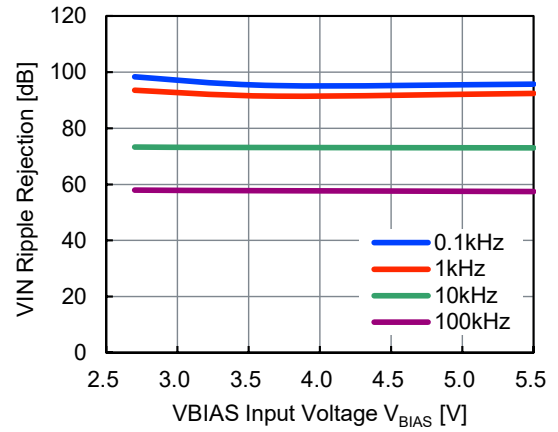

RP120Z201D

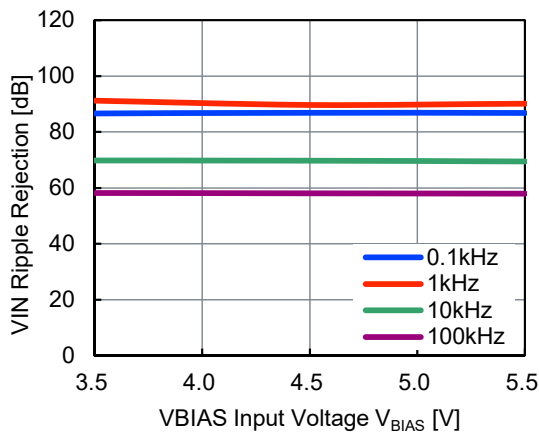

16) VBIAS Ripple Rejection vs. Frequency

$V_{BIAS} = 3.6\text{ V}$, $V_{ripple} = 0.2\text{V p-p}$, $C_E = V_{BIAS}$

RP120Z061D, $V_{IN} = 1.1\text{ V}$

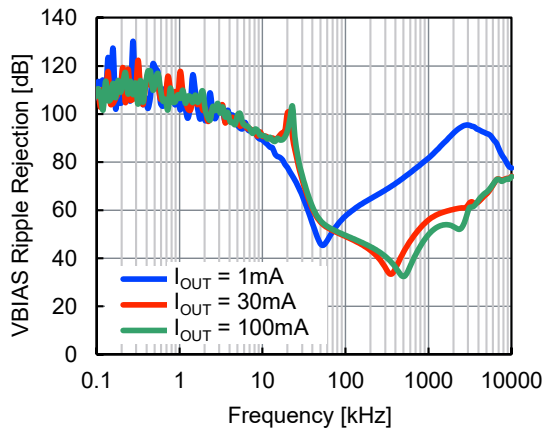

RP120Z121D, $V_{IN} = 1.7\text{ V}$

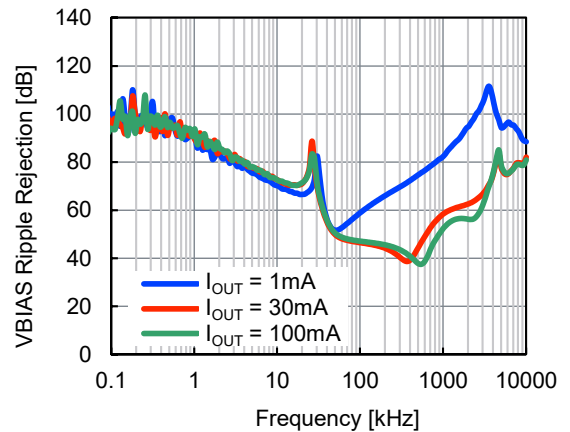

RP120Z201D , $V_{IN} = 2.5\text{ V}$

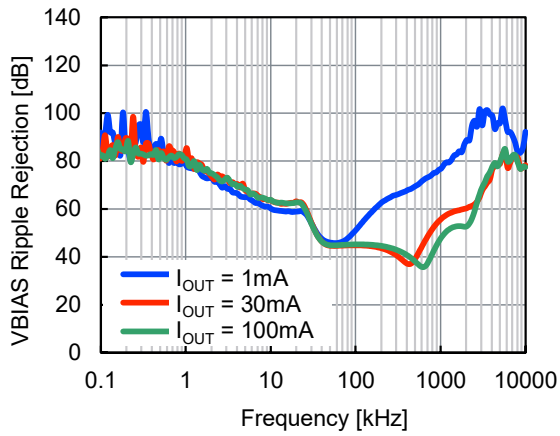

17) V_{IN} Ripple Rejection vs. Frequency

$V_{BIAS} = 3.6\text{ V}$

RP120Z061D , $V_{IN} = 1.1\text{ V}$, $V_{ripple} = 0.2\text{V p-p}$

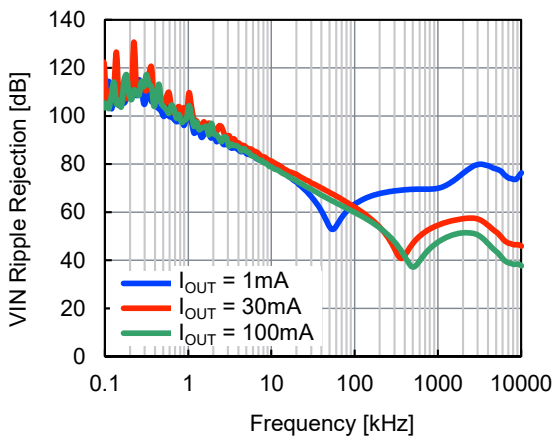

RP120Z121D , $V_{IN} = 1.7\text{ V}$, $V_{ripple} = 0.2\text{V p-p}$

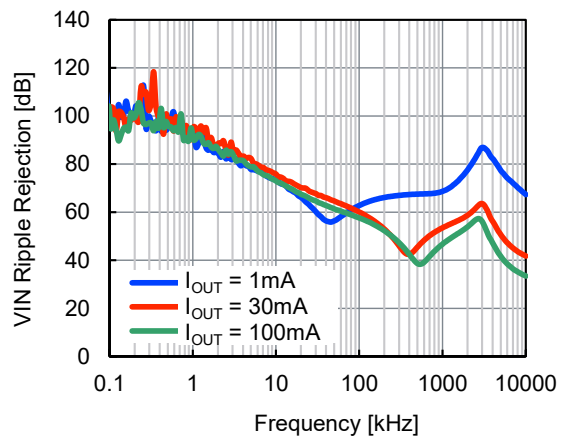

RP120Z201D , $V_{IN} = 2.5\text{ V}$, $V_{ripple} = 0.2\text{V p-p}$

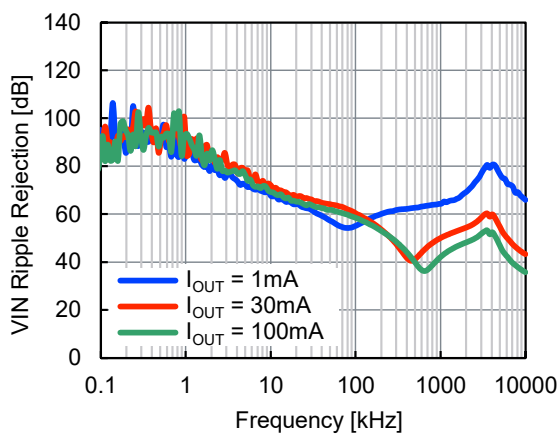

18) VBIAS Input Transient Response

$V_{BIAS} = 3.6 \leftrightarrow 4.6 \text{ V}$, $CE = V_{BIAS}$, $I_{OUT} = 10 \text{ mA}$
 RP120Z061D, $V_{IN} = 1.1 \text{ V}$

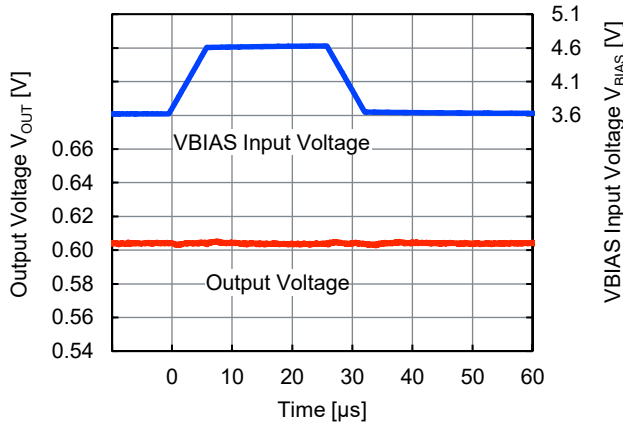

RP120Z121D, $V_{IN} = 1.7 \text{ V}$

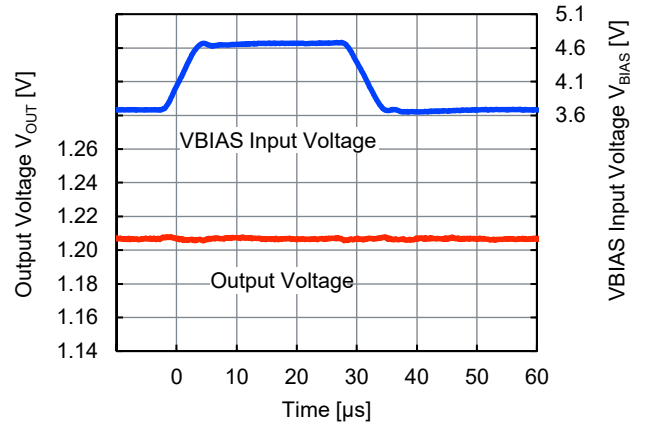

RP120Z201D, $V_{IN} = 2.5 \text{ V}$

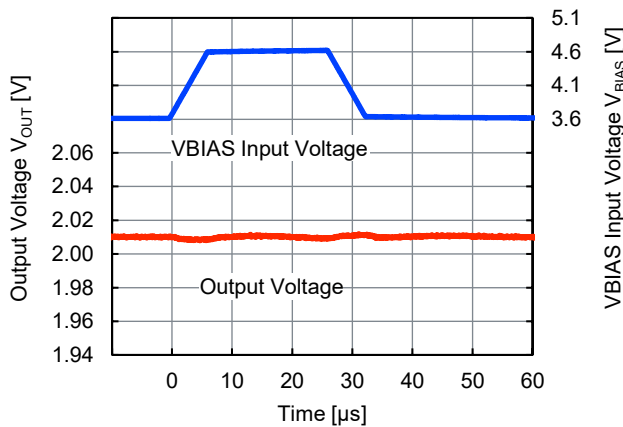

19) VIN Input Transient Response

$V_{BIAS} = 3.6 \text{ V}$, $CE = V_{BIAS}$, $I_{OUT} = 10 \text{ mA}$
 RP120Z061D, $V_{IN} = 1.1 \leftrightarrow 2.1 \text{ V}$

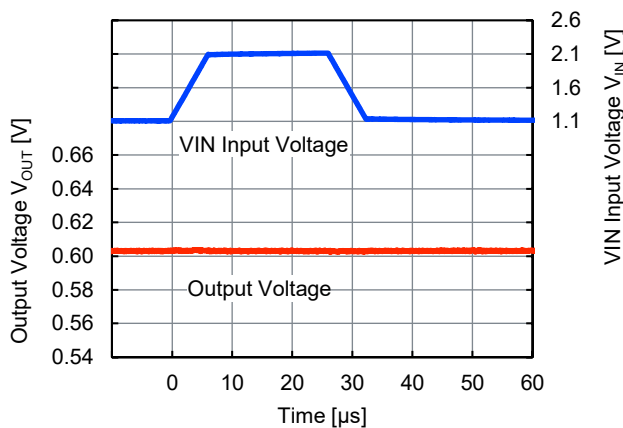

RP120Z121D, $V_{IN} = 1.7 \leftrightarrow 2.7 \text{ V}$

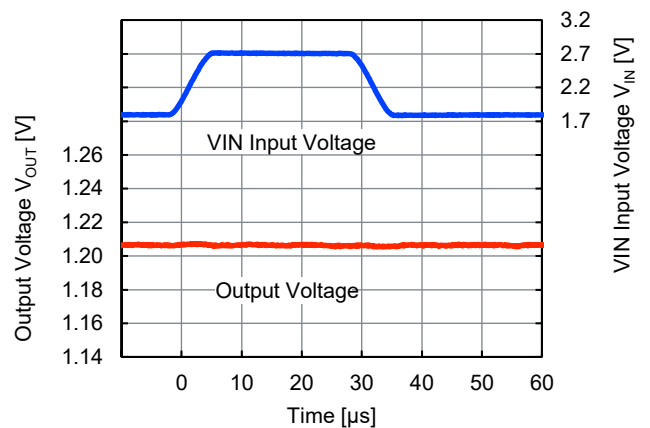

RP120Z201D , $V_{IN} = 2.5 \leftrightarrow 3.5$ V

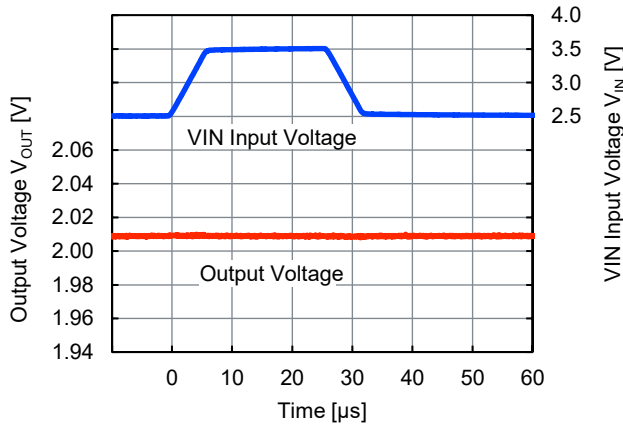

20) Load Transient Response

RP120Z061D , $V_{BIAS} = 3.6$ V , $V_{IN} = 1.1$ V , $CE = V_{BIAS}$
 $tr = tf = 5.0$ μs , $I_{OUT} = 30$ mA \leftrightarrow 1.5 A

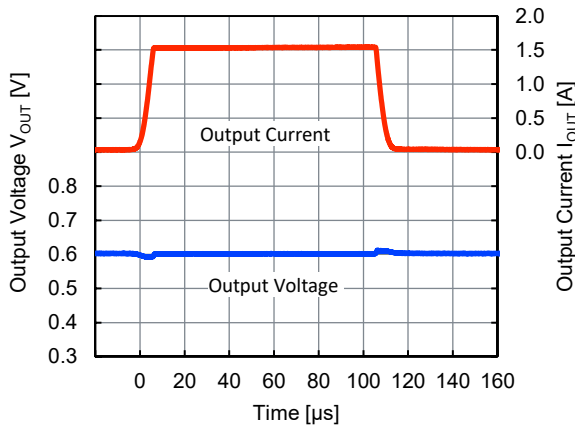

$tr = tf = 1.0$ μs , $I_{OUT} = 30$ mA \leftrightarrow 1.5 A

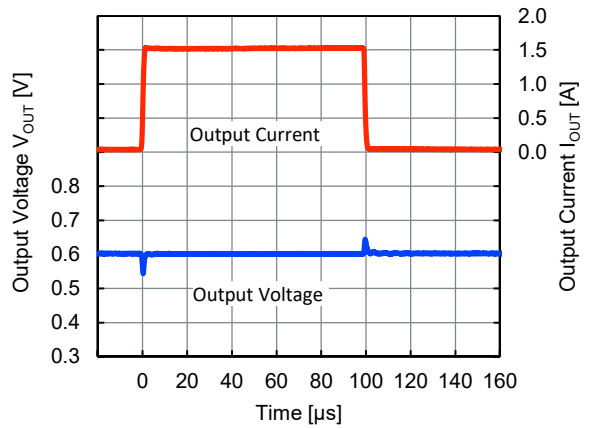

$tr = tf = 5.0$ μs , $I_{OUT} = 1$ mA \leftrightarrow 100 mA

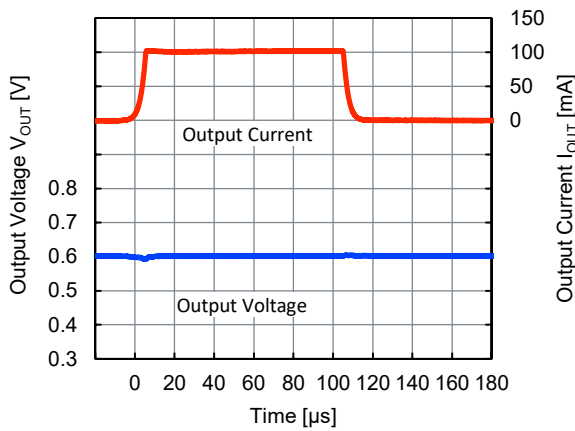

$tr = tf = 0.5$ μs , $I_{OUT} = 1$ mA \leftrightarrow 100 mA

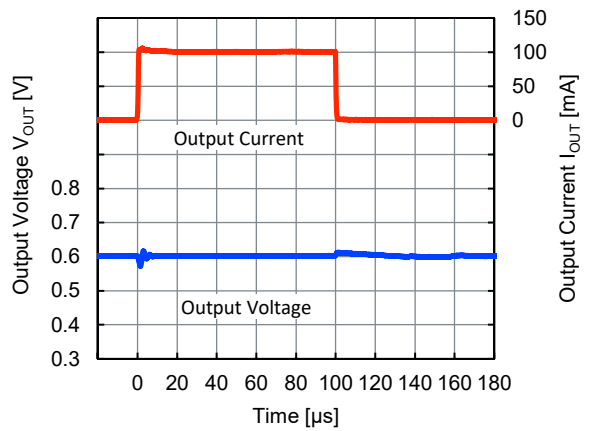

RP120Z121D, $V_{BIAS} = 3.6\text{ V}$, $V_{IN} = 1.7\text{ V}$, $CE = V_{BIAS}$
 $tr = tf = 5.0\ \mu\text{s}$, $I_{OUT} = 30\text{ mA} \Leftrightarrow 1.5\text{ A}$

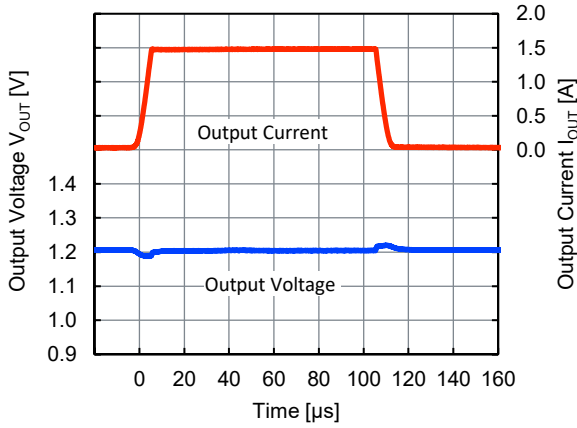

$tr = tf = 1.0\ \mu\text{s}$, $I_{OUT} = 30\text{ mA} \Leftrightarrow 1.5\text{ A}$

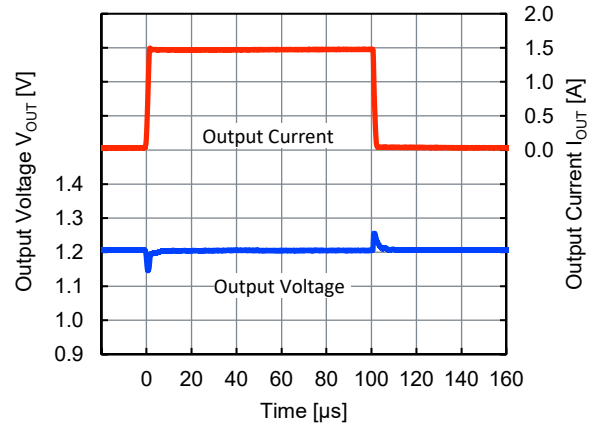

$tr = tf = 5.0\ \mu\text{s}$, $I_{OUT} = 1\text{ mA} \Leftrightarrow 100\text{ mA}$

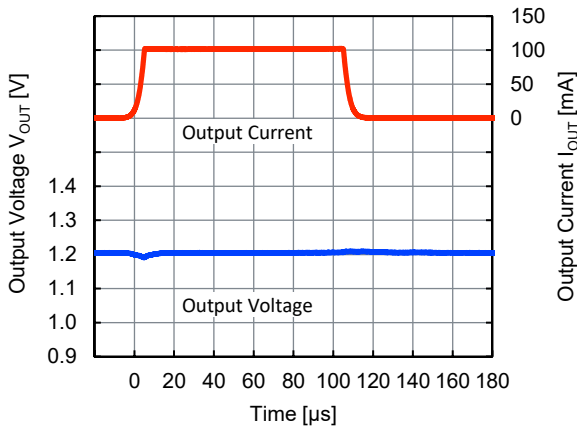

$tr = tf = 0.5\ \mu\text{s}$, $I_{OUT} = 1\text{ mA} \Leftrightarrow 100\text{ mA}$

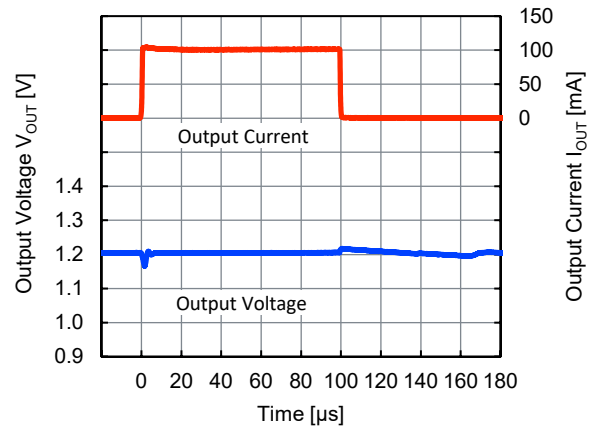

RP120Z201D, $V_{BIAS} = 3.6\text{ V}$, $V_{IN} = 2.5\text{ V}$, $CE = V_{BIAS}$
 $tr = tf = 5.0\ \mu\text{s}$, $I_{OUT} = 30\text{ mA} \Leftrightarrow 1.5\text{ A}$

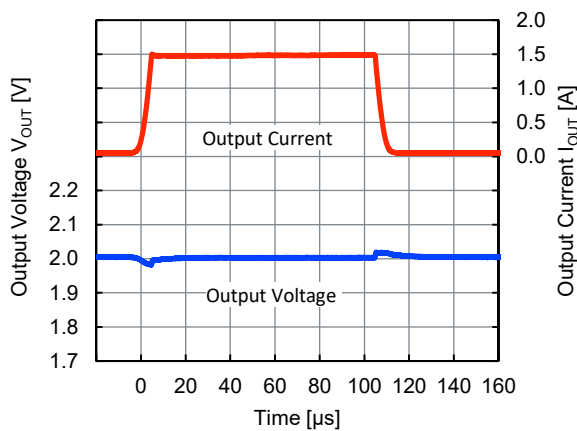

$tr = tf = 1.0\ \mu\text{s}$, $I_{OUT} = 30\text{ mA} \Leftrightarrow 1.5\text{ A}$

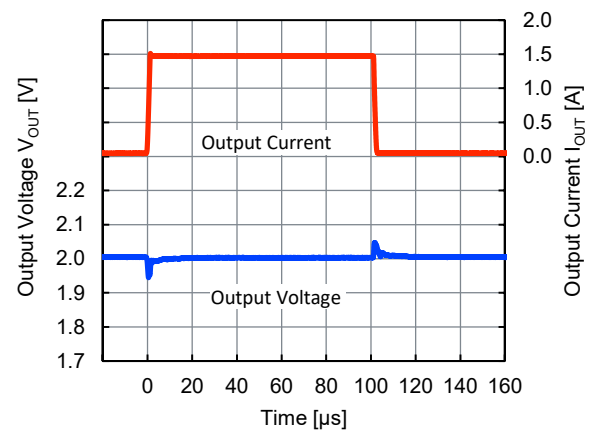

$t_r = t_f = 5.0 \mu s$, $I_{OUT} = 1 \text{ mA} \Leftrightarrow 100 \text{ mA}$

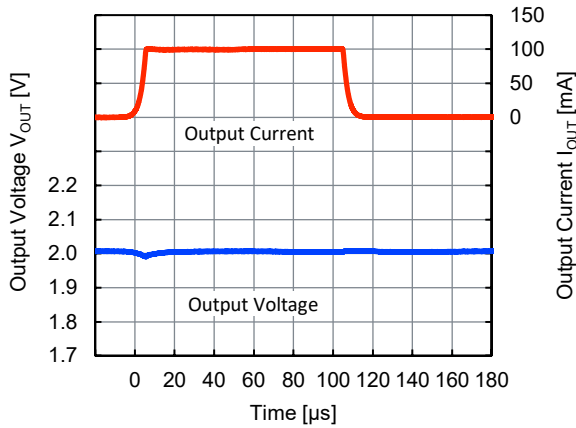

$t_r = t_f = 0.5 \mu s$, $I_{OUT} = 1 \text{ mA} \Leftrightarrow 100 \text{ mA}$

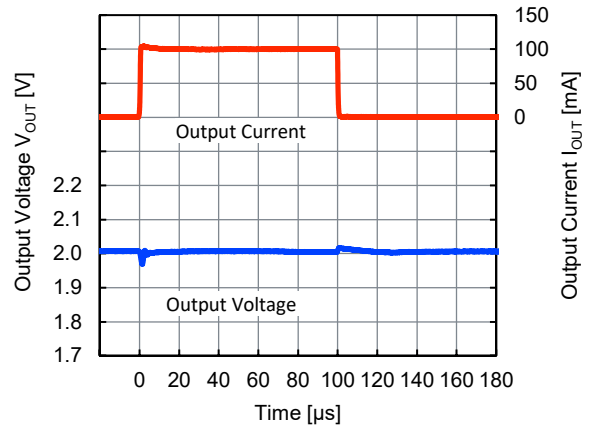

21) Characteristics of Turn On with CE Pin

$V_{BIAS} = 3.6 \text{ V}$, $CE = 0 \text{ V to } V_{BIAS}$, $C_{OUT} = 4.7 \mu F$
 RP120Z061D, $V_{IN} = 1.1 \text{ V}$

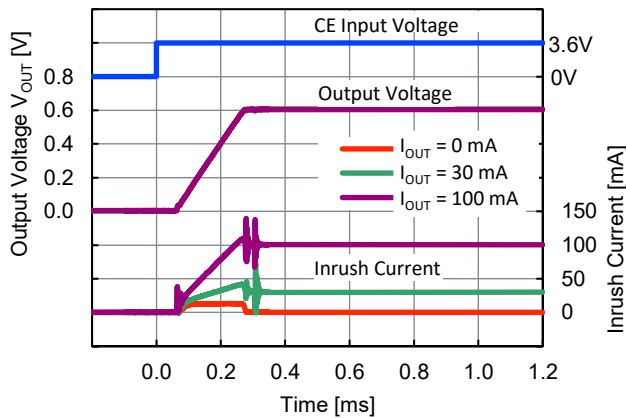

RP120Z121D, $V_{IN} = 1.7 \text{ V}$

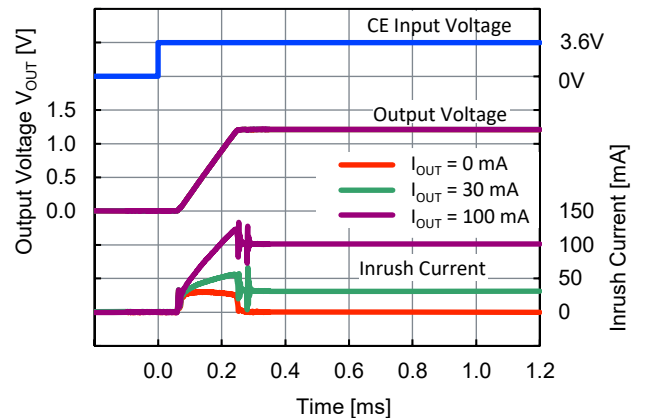

RP120Z201D, $V_{IN} = 2.5 \text{ V}$

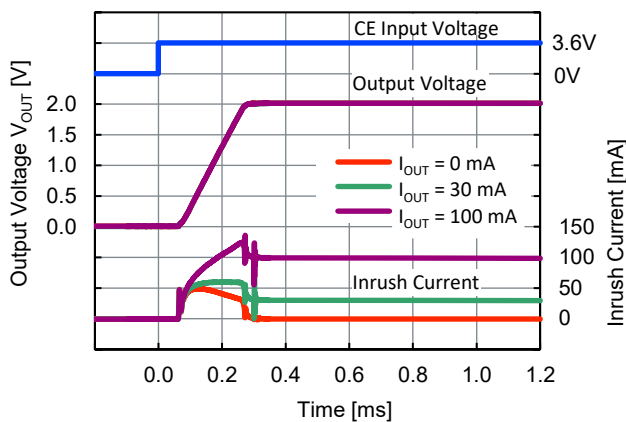

22) Inrush Current

$V_{BIAS} = 3.6\text{ V}$, $CE = 0\text{ V to }V_{BIAS}$, $I_{OUT} = 0\text{ mA}$
 RP120Z061D, $V_{IN} = 1.1\text{ V}$

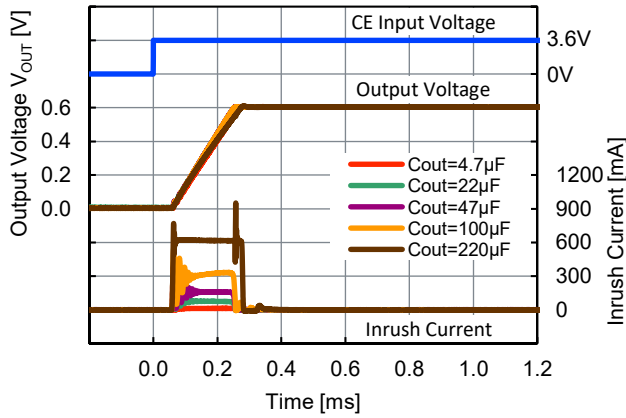

RP120Z121D, $V_{IN} = 1.7\text{ V}$

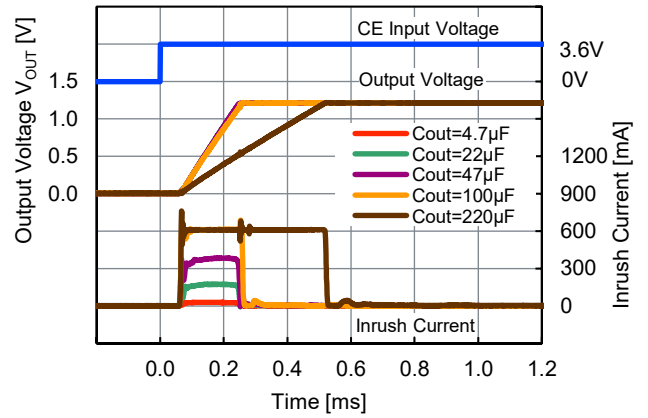

RP120Z201D, $V_{IN} = 2.5\text{ V}$

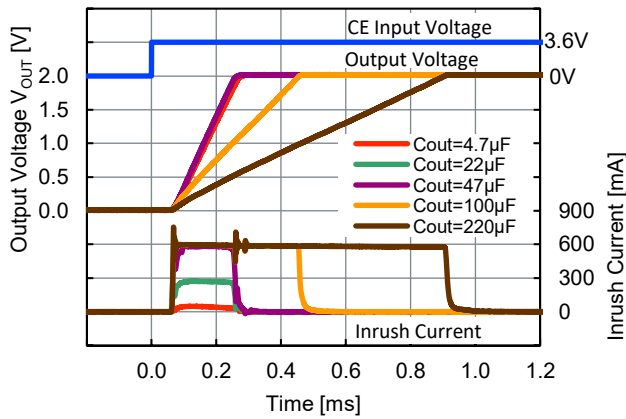

23) Characteristics of Turn Off with CE Pin

$V_{BIAS} = 3.6\text{ V}$, $CE = V_{BIAS}\text{ to }0\text{ V}$, $I_{OUT} = 0\text{ mA}$
 RP120Z061D, $V_{IN} = 1.1\text{ V}$

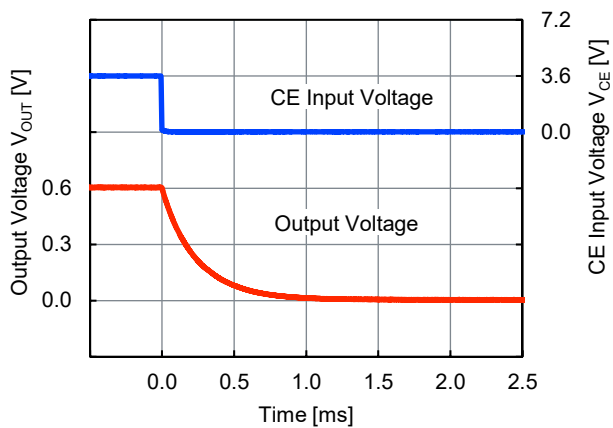

RP120Z121D, $V_{IN} = 1.7\text{ V}$

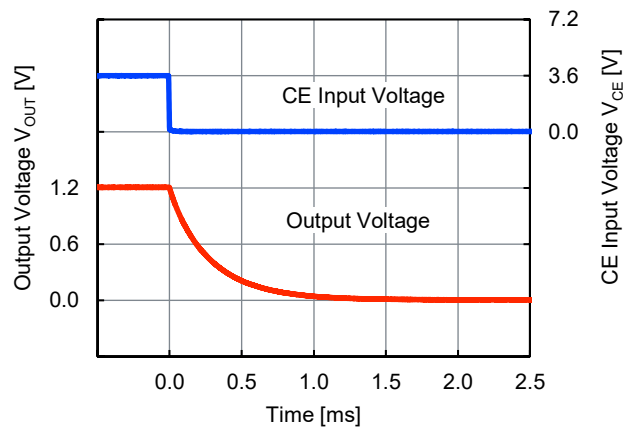

RP120Z201D , $V_{IN} = 2.5\text{ V}$

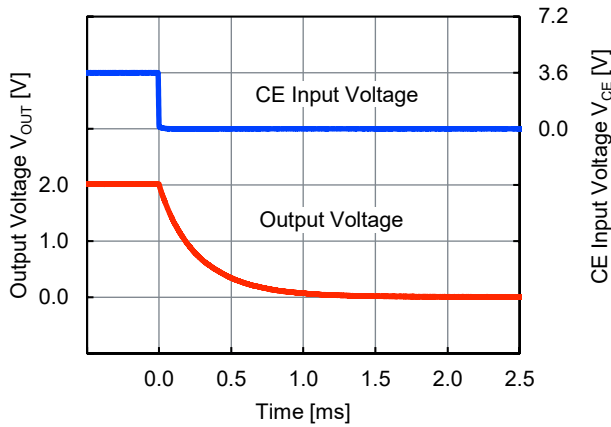

24) V_{IN} Power-on Transient Response

$V_{BIAS} = 3.6\text{ V}$, $CE = V_{BIAS}$, $I_{OUT} = 0\text{ mA}$

RP120Z061D , $V_{IN} = 0\text{ to }1.1\text{ V}$

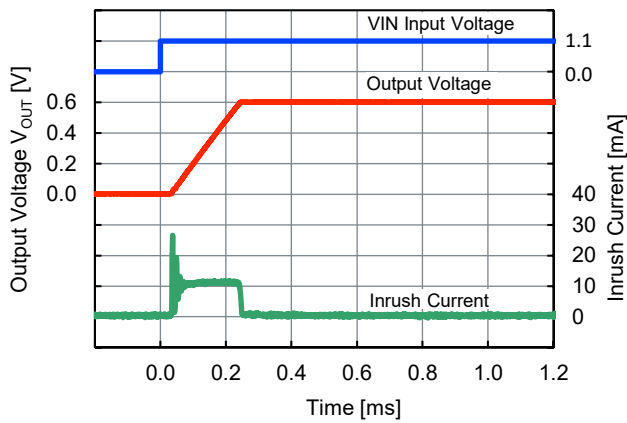

RP120Z121D , $V_{IN} = 0\text{ to }1.7\text{ V}$

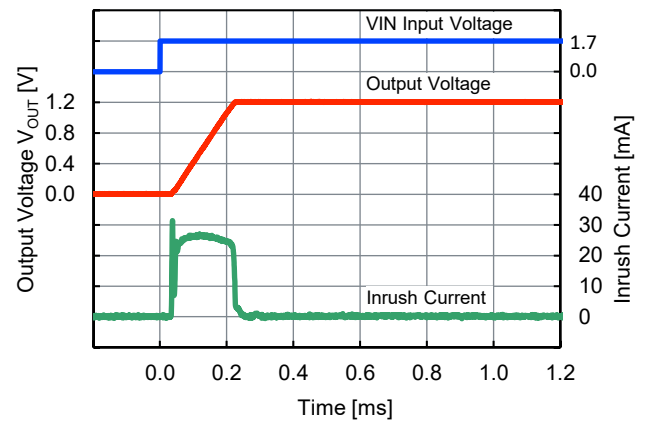

RP120Z201D , $V_{IN} = 0\text{ to }2.5\text{ V}$

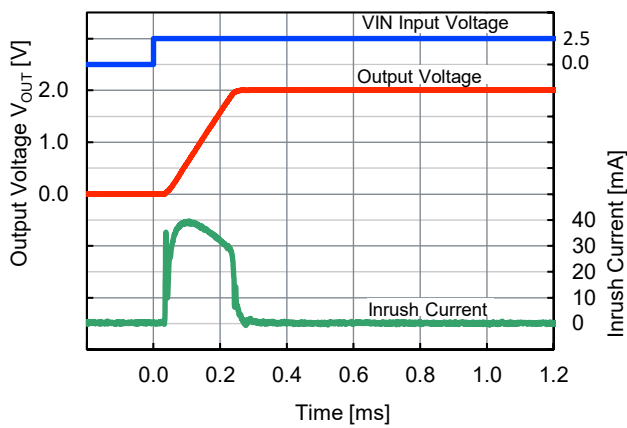

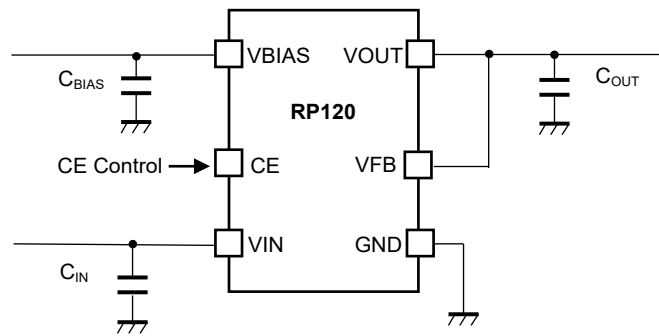
Test Circuit**Test Circuit****Components List for Our Evaluation**

Symbol	Capacitance	Maker	Parts Number
C _{IN}	1 μ F	Murata	GRM033R61A105ME15D
C _{BIAS}	1 μ F	Murata	GRM033R61A105ME15D
C _{OUT}	4.7 μ F	Murata	GRM155R60J475ME47D

PACKAGE DIMENSIONS

WLCSP-6-P11

DM-WLCSP-6-P11-JE-A

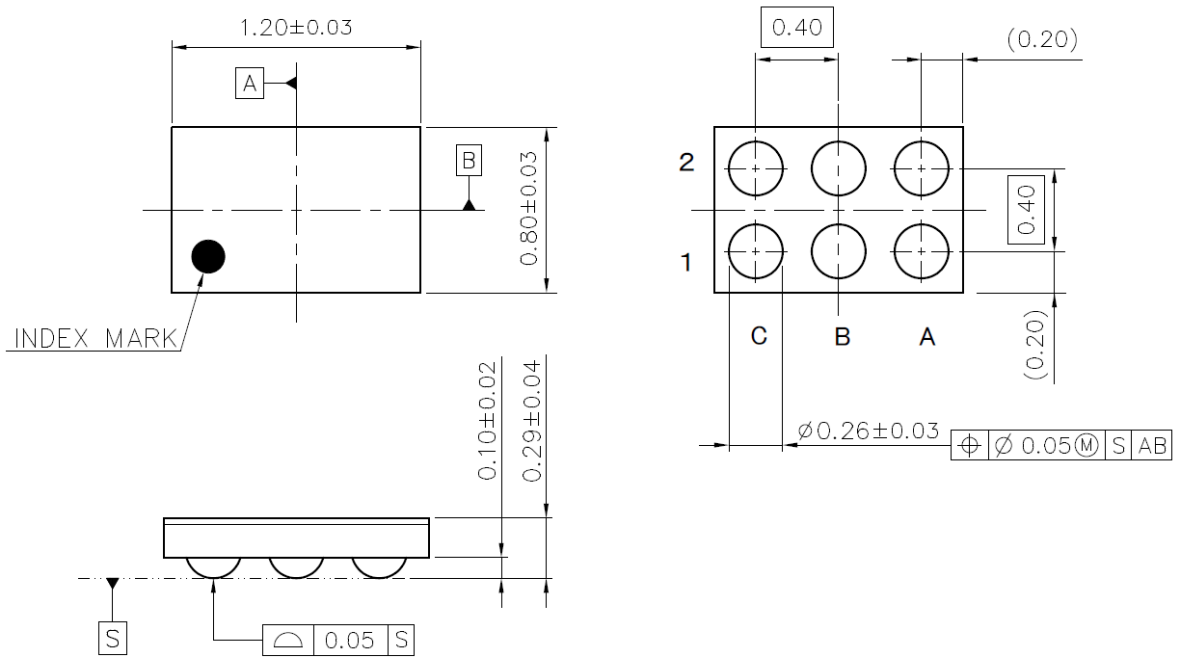

UNIT: mm

WLCSP-6-P11 Package Dimensions

①②: Product Code ... **Refer to the following table**

③④: Lot Number ... Alphanumeric Serial Number

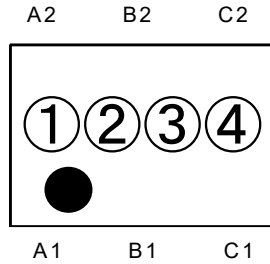

WLCSP-6-P11 Marking Specification

NOTICE

There can be variation in the marking when different AOI (Automated Optical Inspection) equipment is used. In the case of recognizing the marking characteristic with AOI, please contact our sales or distributor before attempting to use AOI.

RP120Z Marking List

Product Name	① ②
RP120Z001D	A A
RP120Z061D	A C
RP120Z071D	A E
RP120Z071D5	A Y
RP120Z081D	A F
RP120Z091D	A G
RP120Z101D	A H
RP120Z111D	A J
RP120Z121D	A K
RP120Z131D	A L
RP120Z141D	A N
RP120Z151D	A P
RP120Z161D	A R
RP120Z171D	A T
RP120Z181D	A U
RP120Z191D	A V
RP120Z201D	A X

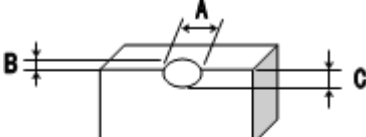
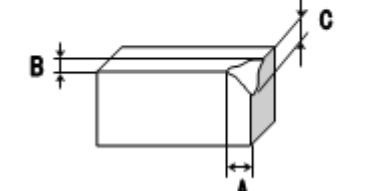
No.	Inspection Items	Inspection Criteria	Figure
1	Package chipping	$A \geq 0.2\text{mm}$ is rejected $B \geq 0.2\text{mm}$ is rejected $C \geq 0.2\text{mm}$ is rejected And, Package chipping to Si surface and to bump is rejected.	
2	Si surface chipping	$A \geq 0.2\text{mm}$ is rejected $B \geq 0.2\text{mm}$ is rejected $C \geq 0.2\text{mm}$ is rejected But, even if $A \geq 0.2\text{mm}$, $B \leq 0.1\text{mm}$ is acceptable.	
3	No bump	No bump is rejected.	
4	Marking miss	To reject incorrect marking, such as another product name marking or another lot No. marking.	
5	No marking	To reject no marking on the package.	
6	Reverse direction of marking	To reject reverse direction of marking character.	
7	Defective marking	To reject unreadable marking. (Microscope: X15/ White LED/ Viewed from vertical direction)	
8	Scratch	To reject unreadable marking character by scratch. (Microscope: X15/ White LED/ Viewed from vertical direction)	
9	Stain and Foreign material	To reject unreadable marking character by stain and foreign material. (Microscope: X15/ White LED/ Viewed from vertical direction)	

1. The products and the product specifications described in this document are subject to change or discontinuation of production without notice for reasons such as improvement. Therefore, before deciding to use the products, please refer to our sales representatives for the latest information thereon.
2. The materials in this document may not be copied or otherwise reproduced in whole or in part without the prior written consent of us.
3. This product and any technical information relating thereto are subject to complementary export controls (so-called KNOW controls) under the Foreign Exchange and Foreign Trade Law, and related politics ministerial ordinance of the law. (Note that the complementary export controls are inapplicable to any application-specific products, except rockets and pilotless aircraft, that are insusceptible to design or program changes.) Accordingly, when exporting or carrying abroad this product, follow the Foreign Exchange and Foreign Trade Control Law and its related regulations with respect to the complementary export controls.
4. The technical information described in this document shows typical characteristics and example application circuits for the products. The release of such information is not to be construed as a warranty of or a grant of license under our or any third party's intellectual property rights or any other rights.
5. The products listed in this document are intended and designed for use as general electronic components in standard applications (office equipment, telecommunication equipment, measuring instruments, consumer electronic products, amusement equipment etc.). Those customers intending to use a product in an application requiring extreme quality and reliability, for example, in a highly specific application where the failure or misoperation of the product could result in human injury or death should first contact us.
 - Aerospace Equipment
 - Equipment Used in the Deep Sea
 - Power Generator Control Equipment (nuclear, steam, hydraulic, etc.)
 - Life Maintenance Medical Equipment
 - Fire Alarms / Intruder Detectors
 - Vehicle Control Equipment (automotive, airplane, railroad, ship, etc.)
 - Various Safety Devices
 - Traffic control system
 - Combustion equipment

In case your company desires to use this product for any applications other than general electronic equipment mentioned above, make sure to contact our company in advance. Note that the important requirements mentioned in this section are not applicable to cases where operation requirements such as application conditions are confirmed by our company in writing after consultation with your company.

6. We are making our continuous effort to improve the quality and reliability of our products, but semiconductor products are likely to fail with certain probability. In order to prevent any injury to persons or damages to property resulting from such failure, customers should be careful enough to incorporate safety measures in their design, such as redundancy feature, fire containment feature and fail-safe feature. We do not assume any liability or responsibility for any loss or damage arising from misuse or inappropriate use of the products.
7. The products have been designed and tested to function within controlled environmental conditions. Do not use products under conditions that deviate from methods or applications specified in this datasheet. Failure to employ the products in the proper applications can lead to deterioration, destruction or failure of the products. We shall not be responsible for any bodily injury, fires or accident, property damage or any consequential damages resulting from misuse or misapplication of the products.
8. **Quality Warranty**
 - 8-1. **Quality Warranty Period**

In the case of a product purchased through an authorized distributor or directly from us, the warranty period for this product shall be one (1) year after delivery to your company. For defective products that occurred during this period, we will take the quality warranty measures described in section 8-2. However, if there is an agreement on the warranty period in the basic transaction agreement, quality assurance agreement, delivery specifications, etc., it shall be followed.
 - 8-2. **Quality Warranty Remedies**

When it has been proved defective due to manufacturing factors as a result of defect analysis by us, we will either deliver a substitute for the defective product or refund the purchase price of the defective product.

Note that such delivery or refund is sole and exclusive remedies to your company for the defective product.
 - 8-3. **Remedies after Quality Warranty Period**

With respect to any defect of this product found after the quality warranty period, the defect will be analyzed by us. On the basis of the defect analysis results, the scope and amounts of damage shall be determined by mutual agreement of both parties. Then we will deal with upper limit in Section 8-2. This provision is not intended to limit any legal rights of your company.
9. Anti-radiation design is not implemented in the products described in this document.
10. The X-ray exposure can influence functions and characteristics of the products. Confirm the product functions and characteristics in the evaluation stage.
11. WLCSP products should be used in light shielded environments. The light exposure can influence functions and characteristics of the products under operation or storage.
12. Warning for handling Gallium and Arsenic (GaAs) products (Applying to GaAs MMIC, Photo Reflector). These products use Gallium (Ga) and Arsenic (As) which are specified as poisonous chemicals by law. For the prevention of a hazard, do not burn, destroy, or process chemically to make them as gas or power. When the product is disposed of, please follow the related regulation and do not mix this with general industrial waste or household waste.
13. Please contact our sales representatives should you have any questions or comments concerning the products or the technical information.



Nisshinbo Micro Devices Inc.

Official website

<https://www.nisshinbo-microdevices.co.jp/en/>

Purchase information

<https://www.nisshinbo-microdevices.co.jp/en/buy/>