

## ALC80G222FP400

Aliases (A547JW222M400G)

ALC80, Aluminum Electrolytic, 2,200 uF, 20%, 400 VDC, -40/+105°C

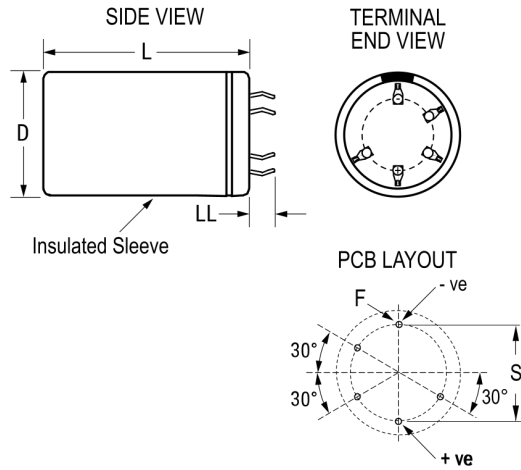

Click [here](#) for the 3D model.

### Dimensions

D	45mm +1mm
L	105mm +/-2mm
S	25mm +/-0.1mm
LL	6.3mm +/-1mm
F	2mm +/-0.1mm

### Packaging Specifications

Sleaving	Yes
Packaging	Bulk, Bag

### General Information

Series	ALC80
Dielectric	Aluminum Electrolytic
Description	Snap-In, Aluminum Electrolytic
RoHS	Yes
Lead	5 Pin
AEC-Q200	No
Halogen Free	Yes
Component Weight	225 g
Notes	Dimensions D And L Include Sleaving.
Shelf Life	156 Weeks

### Specifications

Capacitance	2,200 uF
Capacitance Tolerance	20%
Voltage DC	400 VDC, 440 VDC (Surge)
Temperature Range	-40/+105°C
Rated Temperature	105°C
Life	9000 Hrs (Rated Voltage and Ripple Current at 105C), 14000 Hrs (Rated Voltage at 105C)
Resistance	59.59 mOhms (100Hz 20C), 31.76 mOhms (10kHz 20C)
Ripple Current	7.241 Amps (100Hz 105C), 16.09 Amps (10kHz 105C)
Leakage Current	2640 uA (5min 20°C)