

Three Level NPC Q2Pack Module

NXH400N100L4Q2F2SG, NXH400N100L4Q2F2PG

The NXH400N100L4Q2 is a power module containing a I- type neutral point clamped three-level inverter. The integrated field stop trench IGBTs and FRDs provide lower conduction losses and switching losses, enabling designers to achieve high efficiency and superior reliability.

Features

- Neutral Point Clamped Three-level Inverter Module
- Extreme Efficient Trench with Field Stop Technology
- Low Inductive Layout
- Low Package Height
- Thermistor

Typical Applications

- Solar Inverters
- Energy Storage System
- Uninterruptable Power Supplies Systems

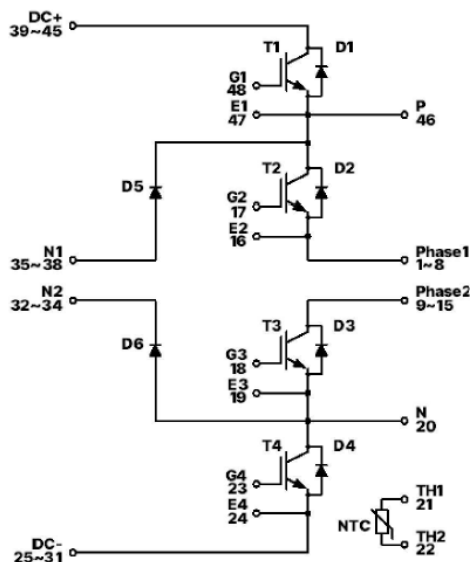
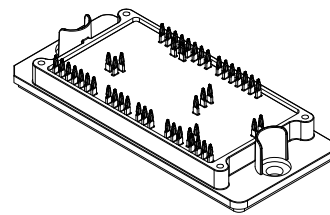
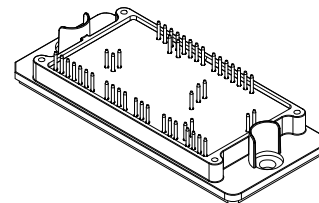

Figure 1. NXH400N100L4Q2F2 Schematic Diagram



Q2PACK PRESS FIT PINS
PIM48, 93x47
CASE 180CR



Q2PACK SOLDER PINS
PIM48, 93x47
CASE 180BL

MARKING DIAGRAM

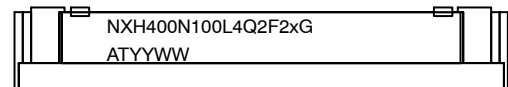

NXH400N100L4Q2F2xG = Specific Device Code
x = P or S
G = Pb-Free Package
AT = Assembly & Test Site Code
YYWW = Year and Work Week Code

PIN CONNECTIONS

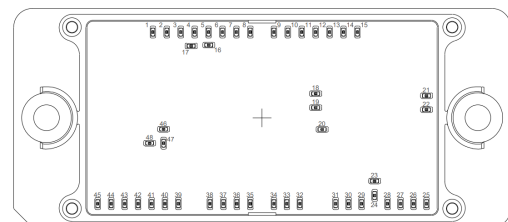

ORDERING INFORMATION

See detailed ordering and shipping information on page 5 of this data sheet.

NXH400N100L4Q2F2SG, NXH400N100L4Q2F2PG

Table 1. ABSOLUTE MAXIMUM RATINGS ($T_J = 25^\circ\text{C}$ unless otherwise noted) (Note 1)

Rating	Symbol	Value	Unit
IGBT (T1, T2, T3, T4)			
Collector-Emitter Voltage	V_{CES}	1000	V
Gate-Emitter Voltage Positive Transient Gate-Emitter Voltage ($T_{pulse} = 5 \mu\text{s}$, $D < 0.10$)	V_{GE}	± 20 30	V
Continuous Collector Current @ $T_C = 80^\circ\text{C}$	I_C	360	A
Pulsed Peak Collector Current @ $T_C = 80^\circ\text{C}$ ($T_J = 175^\circ\text{C}$)	$I_{C(Pulse)}$	1080	A
Maximum Power Dissipation ($T_J = 175^\circ\text{C}$)	P_{tot}	980	W
Minimum Operating Junction Temperature	T_{JMIN}	-40	$^\circ\text{C}$
Maximum Operating Junction Temperature (Note 2)	T_{JMAX}	175	$^\circ\text{C}$

IGBT INVERSE DIODE (D1, D2, D3, D4)

Peak Repetitive Reverse Voltage	V_{RRM}	1000	V
Continuous Forward Current @ $T_C = 80^\circ\text{C}$	I_F	276	A
Repetitive Peak Forward Current ($T_J = 175^\circ\text{C}$)	I_{FRM}	828	A
Maximum Power Dissipation ($T_J = 175^\circ\text{C}$)	P_{tot}	680	W
Minimum Operating Junction Temperature	T_{JMIN}	-40	$^\circ\text{C}$
Maximum Operating Junction Temperature	T_{JMAX}	175	$^\circ\text{C}$

NEUTRAL POINT DIODE (D5, D6)

Peak Repetitive Reverse Voltage	V_{RRM}	1000	V
Continuous Forward Current @ $T_C = 80^\circ\text{C}$	I_F	291	A
Repetitive Peak Forward Current ($T_J = 175^\circ\text{C}$)	I_{FRM}	873	A
Maximum Power Dissipation ($T_J = 175^\circ\text{C}$)	P_{tot}	734	W
Minimum Operating Junction Temperature	T_{JMIN}	-40	$^\circ\text{C}$
Maximum Operating Junction Temperature	T_{JMAX}	175	$^\circ\text{C}$

Stresses exceeding those listed in the Maximum Ratings table may damage the device. If any of these limits are exceeded, device functionality should not be assumed, damage may occur and reliability may be affected.

Table 2. THERMAL AND INSULATION PROPERTIES ($T_J = 25^\circ\text{C}$ unless otherwise noted) (Note 1)

Rating	Symbol	Value	Unit
THERMAL PROPERTIES			
Operating Temperature under Switching Condition	T_{VJOP}	-40 to 150	$^\circ\text{C}$
Storage Temperature Range	T_{stg}	-40 to 125	$^\circ\text{C}$
INSULATION PROPERTIES			
Isolation Test Voltage, $t = 1 \text{ s}$, 50 Hz (Note 2)	V_{is}	4000	V_{RMS}
Creepage Distance		12.7	mm
Comparative Tracking Index	CTI	>600	

Stresses exceeding those listed in the Maximum Ratings table may damage the device. If any of these limits are exceeded, device functionality should not be assumed, damage may occur and reliability may be affected.

1. Refer to [ELECTRICAL CHARACTERISTICS](#), RECOMMENDED OPERATING RANGES and/or APPLICATION INFORMATION for Safe Operating parameters.
2. 4000 V_{ACRMS} for 1 second duration is equivalent to 3333 V_{ACRMS} for 1 minute duration.

NXH400N100L4Q2F2SG, NXH400N100L4Q2F2PG

ELECTRICAL CHARACTERISTICS (T_J = 25°C unless otherwise noted)

Characteristic	Symbol	Test Conditions	Min	Typ	Max	Unit	
OUTER IGBT (T1, T4) CHARACTERISTICS							
Collector-Emitter Cutoff Current	I _{CES}	V _{GE} = 0 V, V _{CE} = 1000 V	–	–	25	μA	
Collector-Emitter Saturation Voltage	V _{CE(sat)}	V _{GE} = 15 V, I _C = 400 A, T _J = 25°C	–	1.65	2.2	V	
		V _{GE} = 15 V, I _C = 400 A, T _J = 150°C	–	1.9	–		
Gate-Emitter Threshold Voltage	V _{GE(TH)}	V _{GE} = V _{CE} , I _C = 400 mA	3.6	4.9	6.2	V	
Gate Leakage Current	I _{GES}	V _{GE} = ±20 V, V _{CE} = 0 V	–	–	±1.0	μA	
Turn-on Delay Time	t _{d(on)}	T _J = 25°C V _{CE} = 600 V, I _C = 200 A V _{GE} = -9 V, 15 V, R _{Gon} = 9 Ω, R _{Goff} = 19 Ω	–	170.46	–	ns	
Rise Time	t _r		–	54.38	–		
Turn-off Delay Time	t _{d(off)}		–	696.63	–		
Fall Time	t _f		–	12.91	–		
Turn-on Switching Loss per Pulse	E _{on}		–	8.96	–		mJ
Turn-off Switching Loss per Pulse	E _{off}		–	7.24	–		
Turn-on Delay Time	t _{d(on)}	T _J = 125°C V _{CE} = 600 V, I _C = 200 A V _{GE} = -9 V, 15 V, R _{Gon} = 9 Ω, R _{Goff} = 19 Ω	–	163.09	–	ns	
Rise Time	t _r		–	61.38	–		
Turn-off Delay Time	t _{d(off)}		–	771.31	–		
Fall Time	t _f		–	18.23	–		
Turn-on Switching Loss per Pulse	E _{on}		–	14.54	–		mJ
Turn-off Switching Loss per Pulse	E _{off}		–	10.73	–		
Input Capacitance	C _{ies}	V _{CE} = 20 V, V _{GE} = 0 V, f = 1 MHz	–	26060	–	pF	
Output Capacitance	C _{oes}		–	1182	–		
Reverse Transfer Capacitance	C _{res}		–	146	–		
Total Gate Charge	Q _g	V _{CE} = 600 V, I _C = 300 A, V _{GE} = -15 V~15 V	–	1410	–	nC	
Thermal Resistance – Chip-to-Heatsink	R _{thJH}	Thermal grease, Thickness = 100 μm ±2% λ = 2.9 W/mK	–	0.17	–	K/W	
Thermal Resistance – Chip-to-Case	R _{thJC}		–	0.0969	–	K/W	

NEUTRAL POINT DIODE (D5, D6) CHARACTERISTICS

Diode Forward Voltage	V _F	I _F = 225 A, T _J = 25°C	–	2.1	2.7	V
		I _F = 225 A, T _J = 150°C	–	1.9	–	
Reverse Recovery Time	t _{rr}	T _J = 25°C V _{CE} = 600 V, I _C = 200 A V _{GE} = -9 V, 15 V, R _G = 9 Ω	–	91.65	–	ns
Reverse Recovery Charge	Q _{rr}		–	5109	–	nC
Peak Reverse Recovery Current	I _{RPM}		–	117.19	–	A
Peak Rate of Fall of Recovery Current	di/dt		–	3.02	–	A/ns
Reverse Recovery Energy	E _{rr}		–	1504	–	μJ
Reverse Recovery Time	t _{rr}		T _J = 125°C V _{CE} = 600 V, I _C = 200 A V _{GE} = -9 V, 15 V, R _G = 9 Ω	–	168.8	–
Reverse Recovery Charge	Q _{rr}	–		15979	–	nC
Peak Reverse Recovery Current	I _{RPM}	–		183.14	–	A
Peak Rate of Fall of Recovery Current	di/dt	–		2.64	–	A/ns
Reverse Recovery Energy	E _{rr}	–		5463	–	μJ
Thermal Resistance – Chip-to-Heatsink	R _{thJH}	Thermal grease, Thickness = 100 μm ±2% λ = 2.9 W/mK		–	0.21	–
Thermal Resistance – Chip-to-Case	R _{thJC}		–	0.1295	–	K/W

NXH400N100L4Q2F2SG, NXH400N100L4Q2F2PG

ELECTRICAL CHARACTERISTICS ($T_J = 25^\circ\text{C}$ unless otherwise noted) (continued)

Characteristic	Symbol	Test Conditions	Min	Typ	Max	Unit	
INNER IGBT (T2, T3) CHARACTERISTICS							
Collector–Emitter Cutoff Current	I_{CES}	$V_{GE} = 0\text{ V}, V_{CE} = 1000\text{ V}$	–	–	25	μA	
Collector–Emitter Saturation Voltage	$V_{CE(sat)}$	$V_{GE} = 15\text{ V}, I_C = 400\text{ A}, T_J = 25^\circ\text{C}$	–	1.65	2.2	V	
		$V_{GE} = 15\text{ V}, I_C = 400\text{ A}, T_J = 150^\circ\text{C}$	–	1.9	–		
Gate–Emitter Threshold Voltage	$V_{GE(TH)}$	$V_{GE} = V_{CE}, I_C = 400\text{ mA}$	3.9	4.6	5.8	V	
Gate Leakage Current	I_{GES}	$V_{GE} = \pm 20\text{ V}, V_{CE} = 0\text{ V}$	–	–	± 1.0	μA	
Turn–on Delay Time	$t_{d(on)}$	$T_J = 25^\circ\text{C}$ $V_{CE} = 600\text{ V}, I_C = 200\text{ A},$ $V_{GE} = -9\text{ V}, 15\text{ V},$ $R_{Gon} = 9\ \Omega, R_{Goff} = 28\ \Omega$	–	171.27	–	ns	
Rise Time	t_r		–	52.54	–		
Turn–off Delay Time	$t_{d(off)}$		–	1153.7	–		
Fall Time	t_f		–	34.88	–		
Turn–on Switching Loss per Pulse	E_{on}		–	8.16	–		mJ
Turn off Switching Loss per Pulse	E_{off}		–	10.25	–		
Turn–on Delay Time	$t_{d(on)}$	$T_J = 125^\circ\text{C}$ $V_{CE} = 600\text{ V}, I_C = 200\text{ A},$ $V_{GE} = -9\text{ V}, 15\text{ V},$ $R_{Gon} = 9\ \Omega, R_{Goff} = 28\ \Omega$	–	160.21	–	ns	
Rise Time	t_r		–	59.83	–		
Turn–off Delay Time	$t_{d(off)}$		–	1274.8	–		
Fall Time	t_f		–	26.46	–		
Turn–on Switching Loss per Pulse	E_{on}		–	12.37	–		mJ
Turn off Switching Loss per Pulse	E_{off}		–	13.42	–		
Input Capacitance	C_{ies}	$V_{CE} = 20\text{ V}, V_{GE} = 0\text{ V}, f = 1\text{ MHz}$	–	26060	–	μF	
Output Capacitance	C_{oes}		–	1182	–		
Reverse Transfer Capacitance	C_{res}		–	146	–		
Total Gate Charge	Q_g	$V_{CE} = 600\text{ V}, I_C = 300\text{ A},$ $V_{GE} = -15\text{ V} \sim 15\text{ V}$	–	1410	–	nC	
Thermal Resistance – Chip–to–heatsink	R_{thJH}	Thermal grease, Thickness = $100\ \mu\text{m} \pm 2\%$ $\lambda = 2.9\text{ W/mK}$	–	0.17	–	K/W	
Thermal Resistance – Chip–to–case	R_{thJC}		–	0.0969	–	K/W	

IGBT INVERSE DIODE (D1, D2, D3, D4) CHARACTERISTICS

Diode Forward Voltage	V_F	$I_F = 225\text{ A}, T_J = 25^\circ\text{C}$	–	2.1	2.7	V				
		$I_F = 225\text{ A}, T_J = 150^\circ\text{C}$	–	1.9	–					
Reverse Recovery Time	t_{rr}	$T_J = 25^\circ\text{C}$ $V_{CE} = 600\text{ V}, I_C = 200\text{ A}$ $V_{GE} = -9\text{ V}, 15\text{ V}, R_G = 9\ \Omega$	–	90.31	–	ns				
Reverse Recovery Charge	Q_{rr}		–	5653	–		nC			
Peak Reverse Recovery Current	I_{RRM}		–	123.4	–			A		
Peak Rate of Fall of Recovery Current	di/dt		–	3.178	–				A/ns	
Reverse Recovery Energy	E_{rr}		–	1860	–					μJ
Reverse Recovery Time	t_{rr}		$T_J = 125^\circ\text{C}$ $V_{CE} = 600\text{ V}, I_C = 200\text{ A}$ $V_{GE} = -9\text{ V}, 15\text{ V}, R_G = 9\ \Omega$	–	167.18					
Reverse Recovery Charge	Q_{rr}	–		16627	–	nC				
Peak Reverse Recovery Current	I_{RRM}	–		182.8	–		A			
Peak Rate of Fall of Recovery Current	di/dt	–		2.734	–			A/ns		
Reverse Recovery Energy	E_{rr}	–		6512	–				μJ	
Thermal Resistance – Chip-to-Heatsink	R_{thJH}	Thermal grease, Thickness = $100\ \mu\text{m} \pm 2\%$ $\lambda = 2.9\text{ W/mK}$		–	0.22					–
Thermal Resistance – Chip-to-Case	R_{thJC}		–	0.1397	–					K/W

THERMISTOR CHARACTERISTICS

Nominal Resistance	R_{25}	$T = 25^\circ\text{C}$	–	5	–	k Ω
Nominal Resistance	R_{100}	$T = 100^\circ\text{C}$	–	492.2	–	Ω

NXH400N100L4Q2F2SG, NXH400N100L4Q2F2PG

ELECTRICAL CHARACTERISTICS ($T_J = 25^\circ\text{C}$ unless otherwise noted) (continued)

Characteristic	Symbol	Test Conditions	Min	Typ	Max	Unit
THERMISTOR CHARACTERISTICS						
Deviation of R25	$\Delta R/R$		-1	-	1	%
Power Dissipation	P_D		-	5	-	mW
Power Dissipation Constant			-	2	-	mW/K
B-value		B (25/50), tolerance $\pm 3\%$	-	1.3	-	K
B-value		B (25/100), tolerance $\pm 3\%$	-	3430	-	K

Product parametric performance is indicated in the Electrical Characteristics for the listed test conditions, unless otherwise noted. Product performance may not be indicated by the Electrical Characteristics if operated under different conditions.

ORDERING INFORMATION

Part Number	Marking	Package	Shipping
NXH400N100L4Q2F2PG	NXH400N100L4Q2F2PG	Q2PACK PRESS FIT PINS PIM48, 93x47 (Pb-Free and Halide-Free)	12 Units / Blister Tray
NXH400N100L4Q2F2SG	NXH400N100L4Q2F2SG	Q2PACK SOLDER PIN PIM48, 93x47 (Pb-Free and Halide-Free)	12 Units / Blister Tray

NXH400N100L4Q2F2SG, NXH400N100L4Q2F2PG

TYPICAL CHARACTERISTICS – IGBT, INVERSE DIODE AND NEUTRAL POINT DIODE

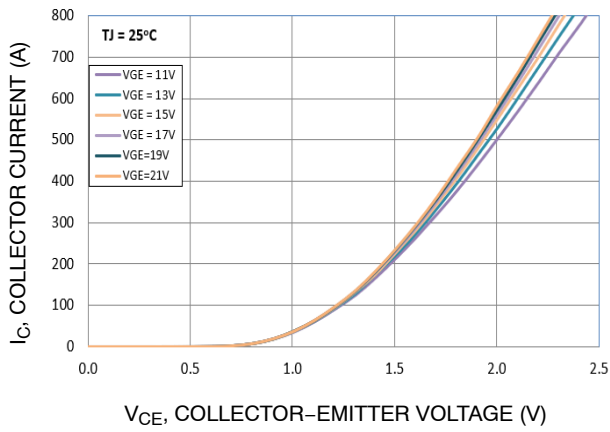

Figure 2. Typical Output Characteristics – IGBT

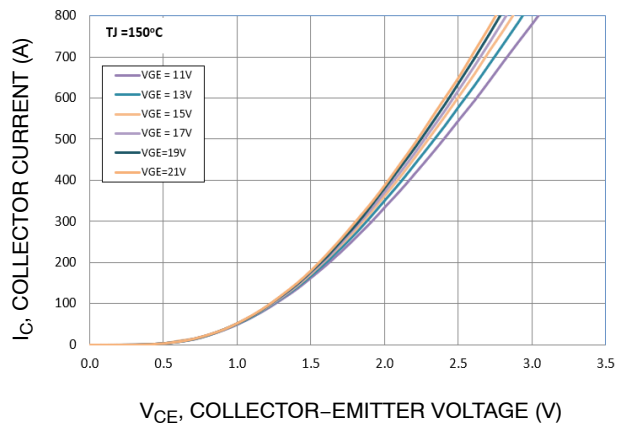

Figure 3. Typical Output Characteristics – IGBT

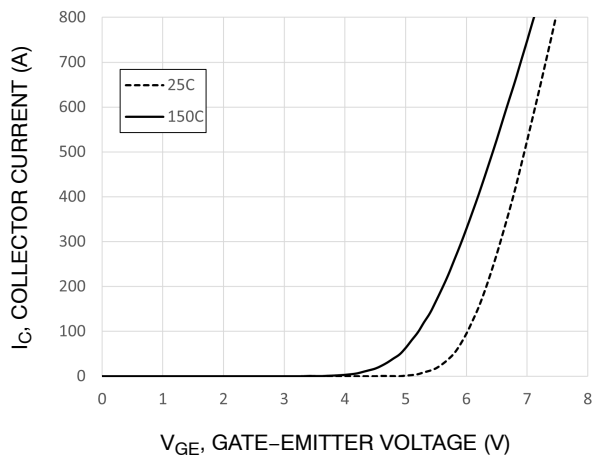

Figure 4. Transfer Characteristics – IGBT

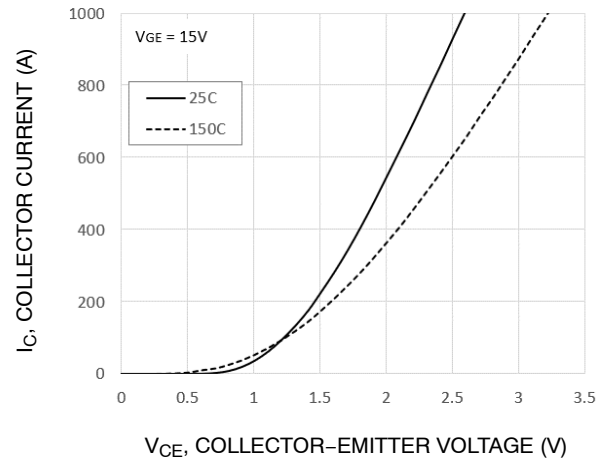

Figure 5. Saturation Voltage Characteristics

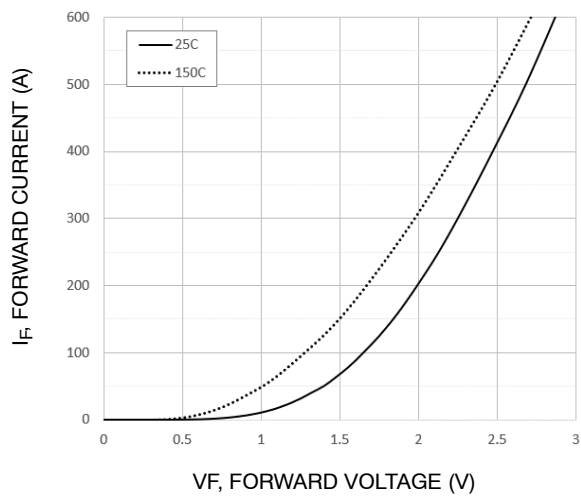

Figure 6. Inverse Diode Forward Characteristics

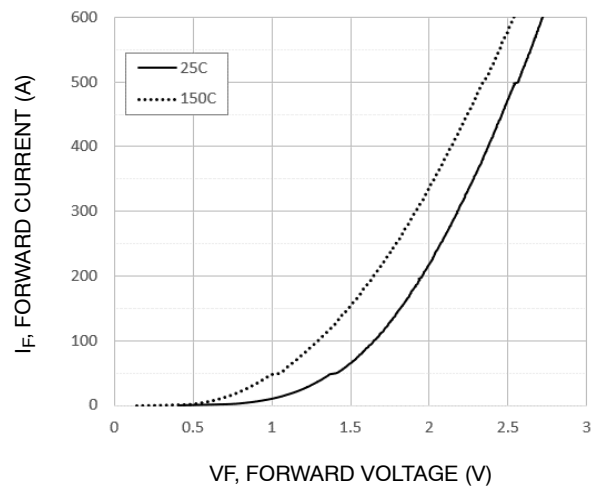

Figure 7. Buck Diode Forward Characteristics

NXH400N100L4Q2F2SG, NXH400N100L4Q2F2PG

TYPICAL CHARACTERISTICS – OUTER IGBT (T1, T4)

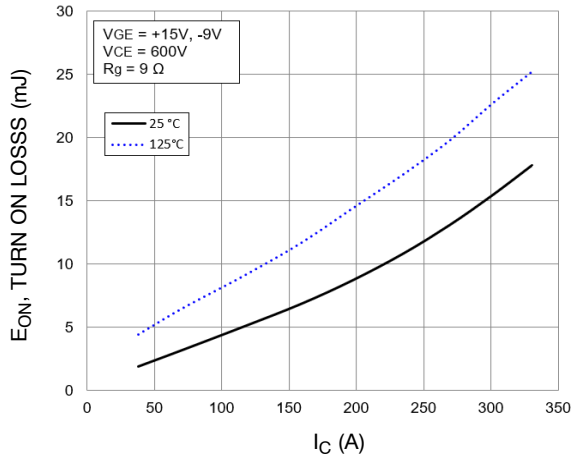

Figure 8. Typical Turn ON Loss vs. IC

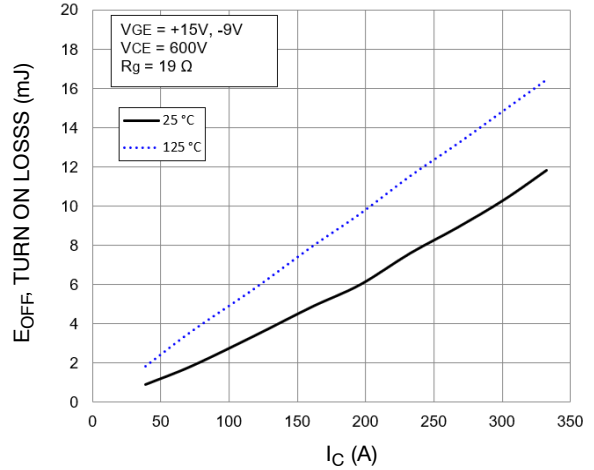

Figure 9. Typical Turn OFF Loss vs. IC

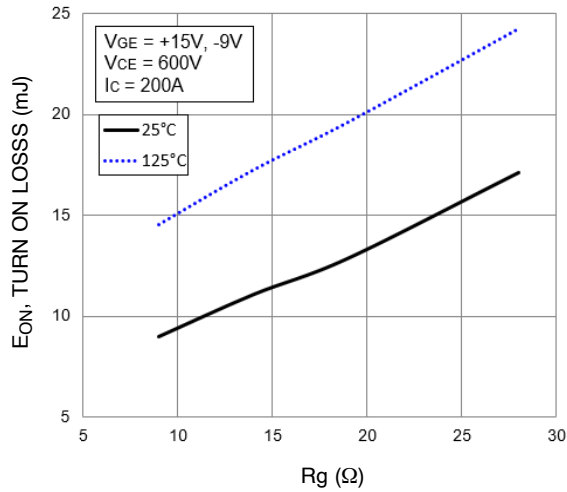

Figure 10. Typical Turn ON Loss vs. Rg

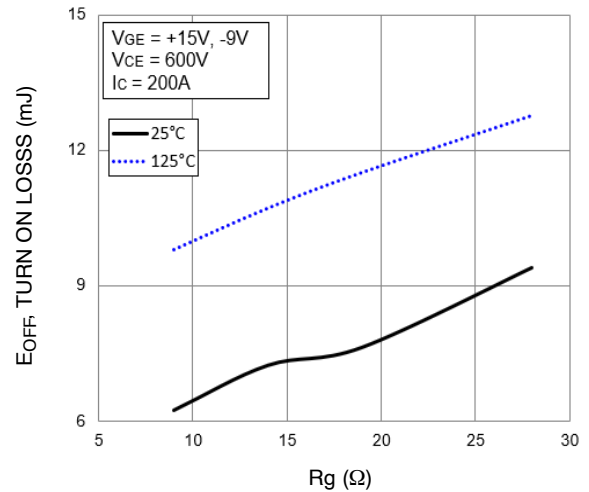

Figure 11. Typical Turn OFF Loss vs. Rg

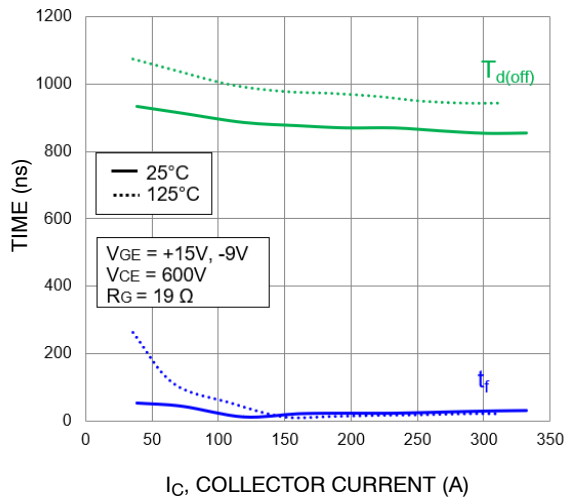

Figure 12. Typical Turn-Off Switching Time vs. IC

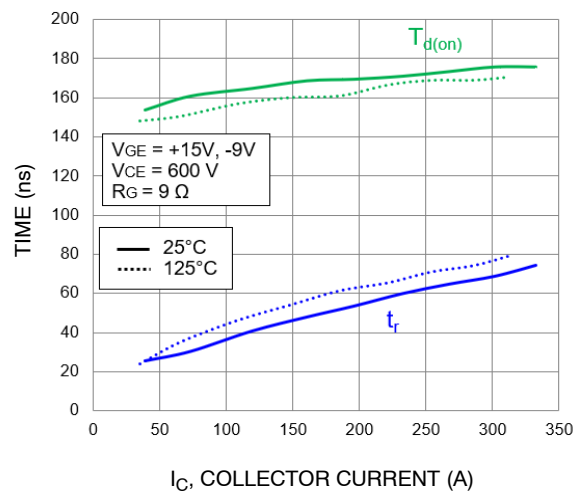

Figure 13. Typical Turn-On Switching Time vs. IC

NXH400N100L4Q2F2SG, NXH400N100L4Q2F2PG

TYPICAL CHARACTERISTICS – OUTER IGBT (T1,T4) (continued)

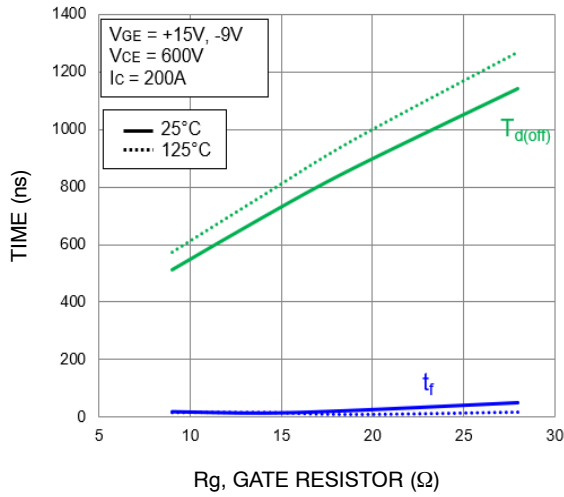

Figure 14. Typical Turn-Off Switching Time vs. RG

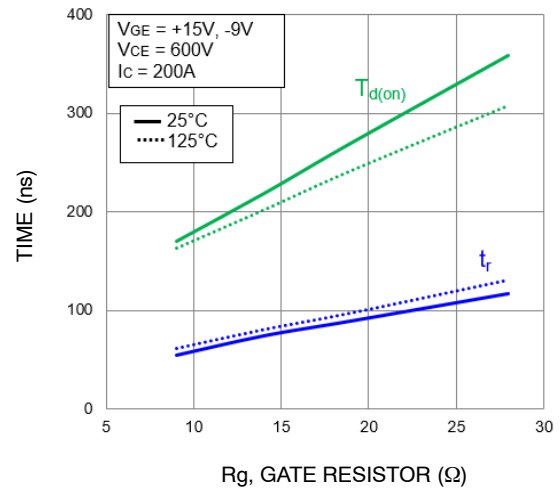

Figure 15. Typical Turn-On Switching Time vs. RG

NXH400N100L4Q2F2SG, NXH400N100L4Q2F2PG

TYPICAL CHARACTERISTICS – INNER IGBT (T2, T3)

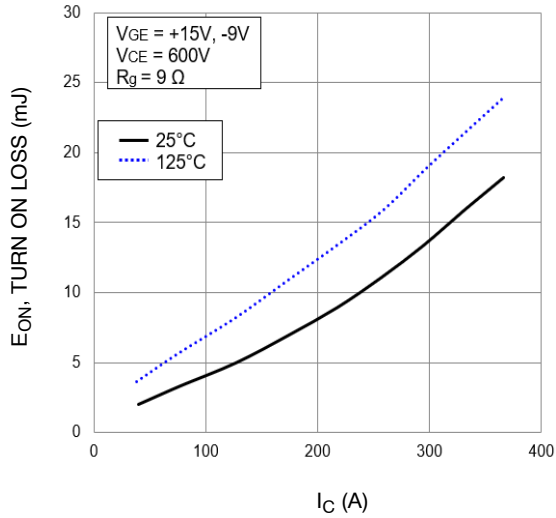

Figure 16. Typical Turn ON Loss vs. IC

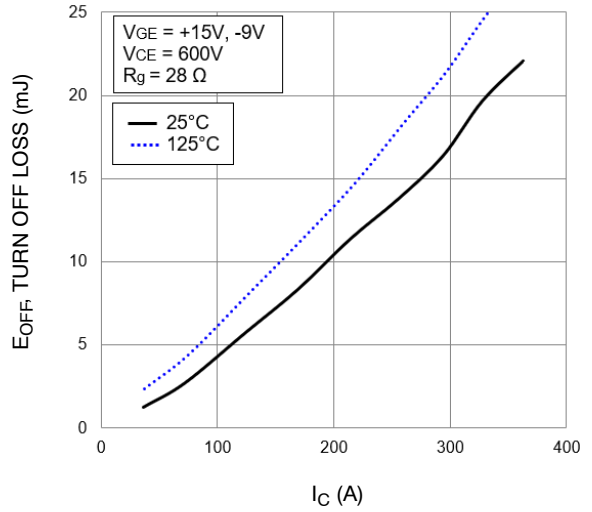

Figure 17. Typical Turn OFF Loss vs. IC

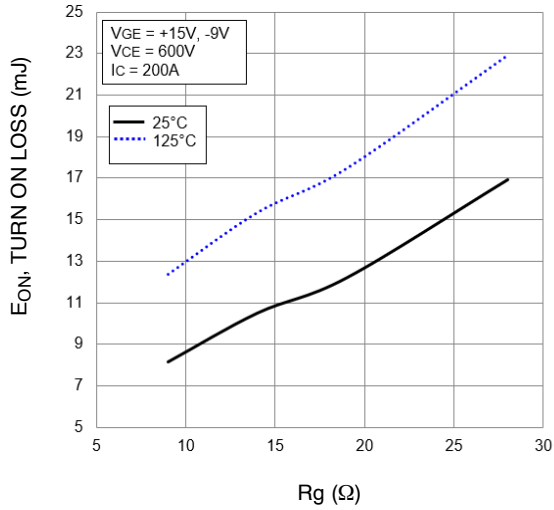

Figure 18. Typical Turn ON Loss vs. Rg

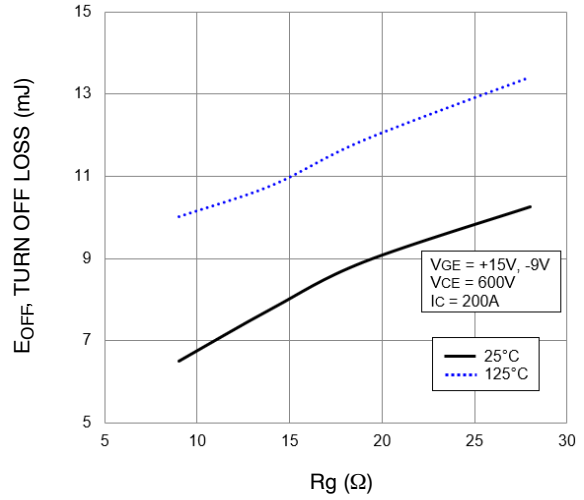

Figure 19. Typical Turn OFF Loss vs. Rg

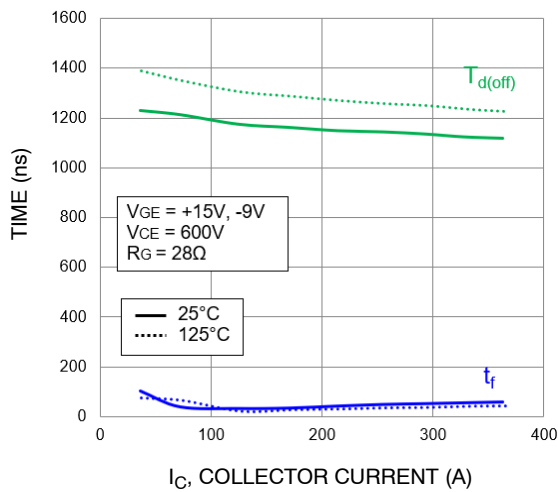

Figure 20. Typical Turn-Off Switching Time vs. IC

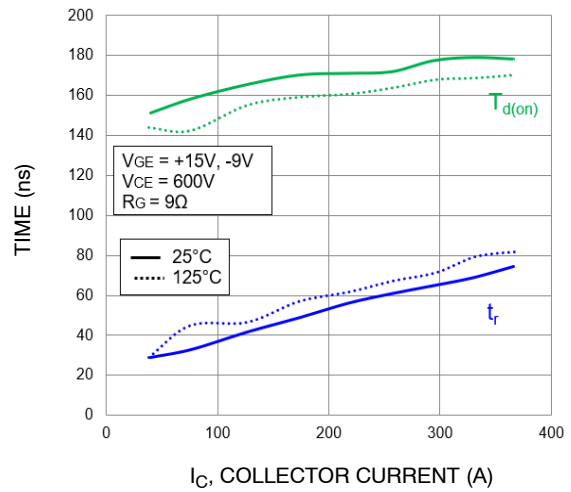

Figure 21. Typical Turn-On Switching Time vs. IC

NXH400N100L4Q2F2SG, NXH400N100L4Q2F2PG

TYPICAL CHARACTERISTICS – INNER IGBT (T2, T3) (continued)

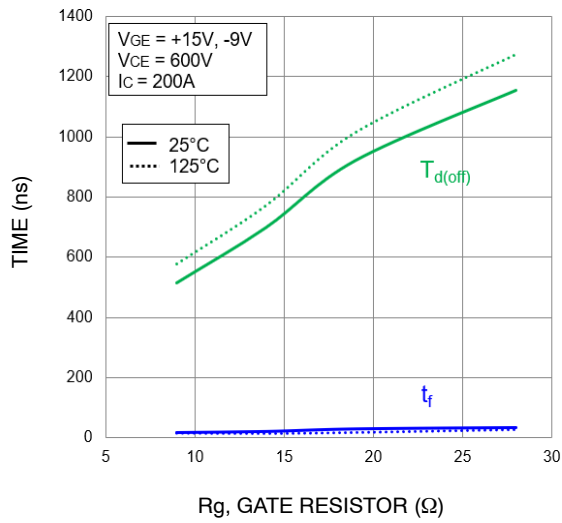

Figure 22. Typical Turn-Off Switching Time vs. RG

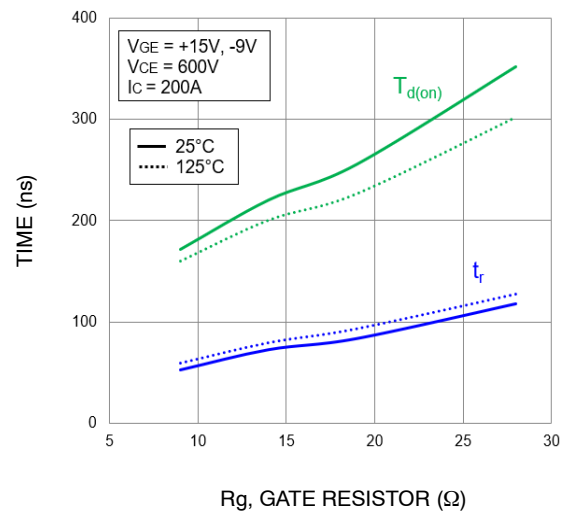

Figure 23. Typical Turn-On Switching Time vs. RG

TYPICAL SWITCHING CHARACTERISTICS – NEUTRAL POINT DIODE

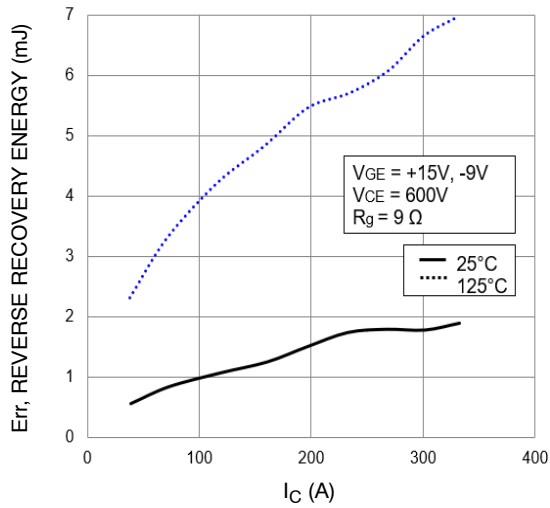

Figure 24. Typical Reverse Recovery Energy Loss vs. IC

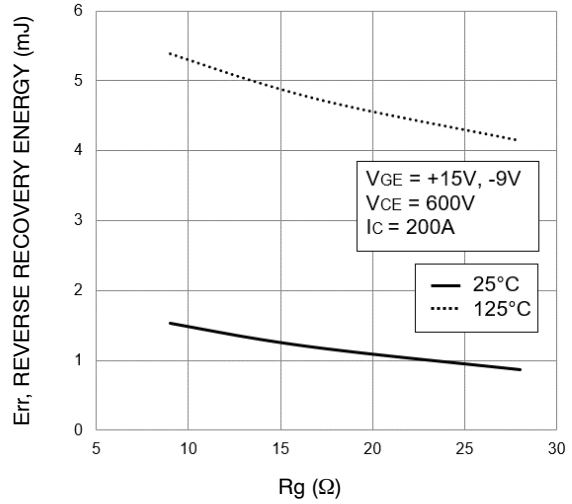

Figure 25. Typical Reverse Recovery Energy Loss vs. Rg

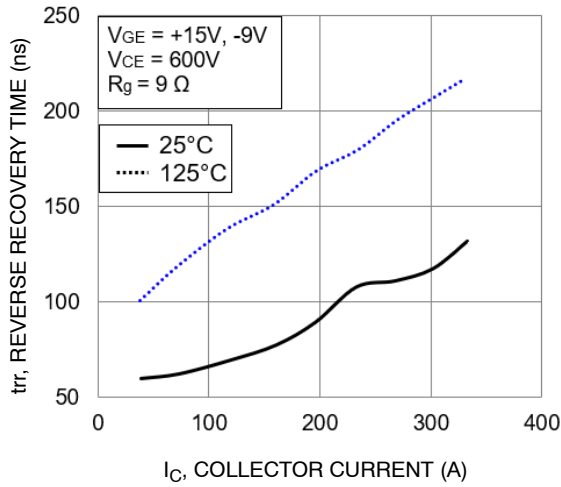

Figure 26. Typical Reverse Recovery Time vs. IC

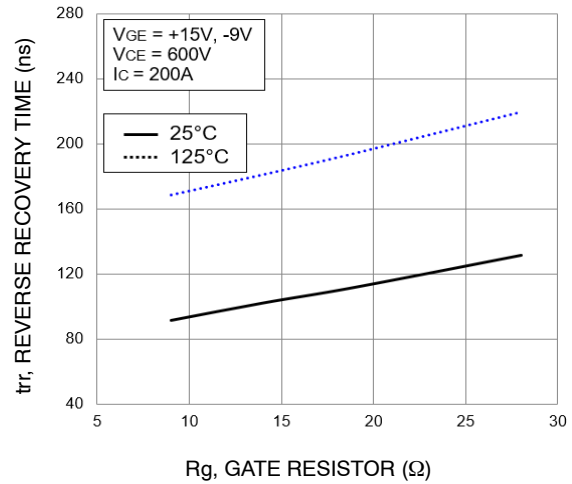

Figure 27. Typical Reverse Recovery Time vs. Rg

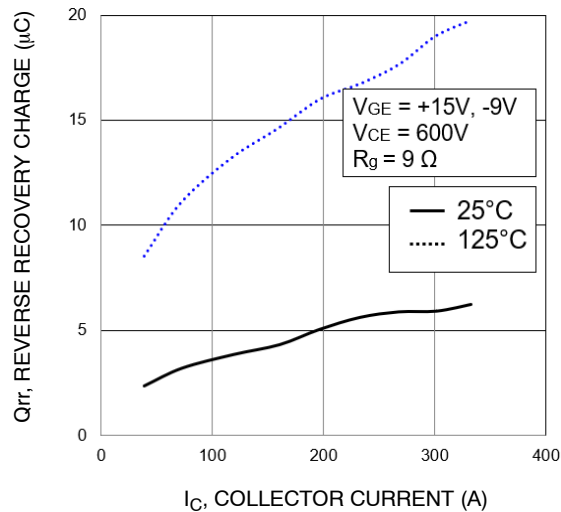

Figure 28. Typical Reverse Recovery Charge vs. IC

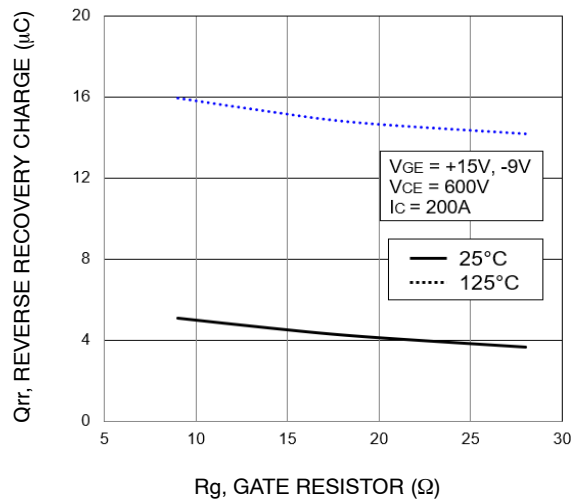

Figure 29. Typical Reverse Recovery Charge vs. Rg

NXH400N100L4Q2F2SG, NXH400N100L4Q2F2PG

TYPICAL SWITCHING CHARACTERISTICS – NEUTRAL POINT DIODE (continued)

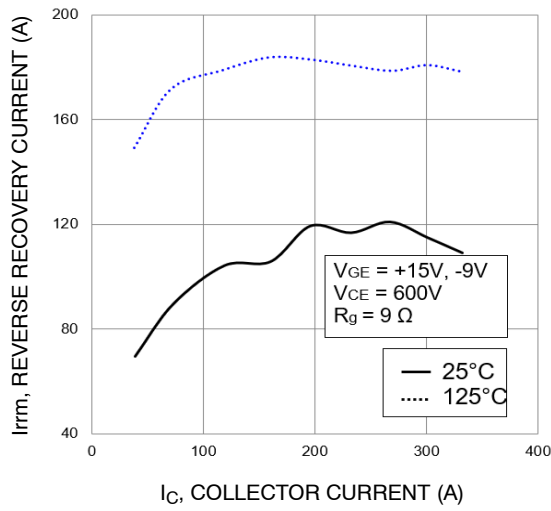

Figure 30. Typical Reverse Recovery Peak Current vs. IC

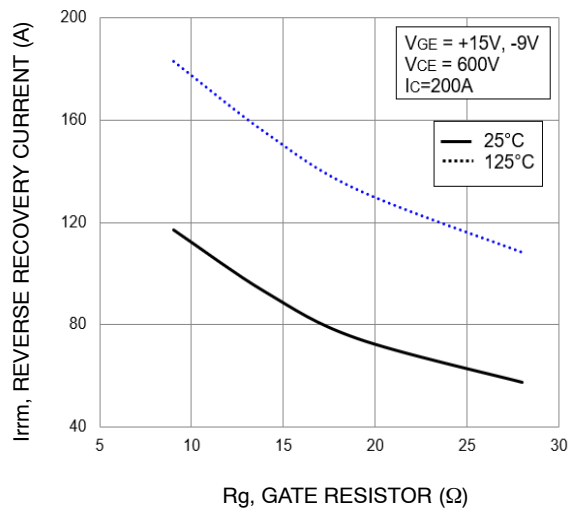

Figure 31. Typical Reverse Recovery Peak Current vs. Rg

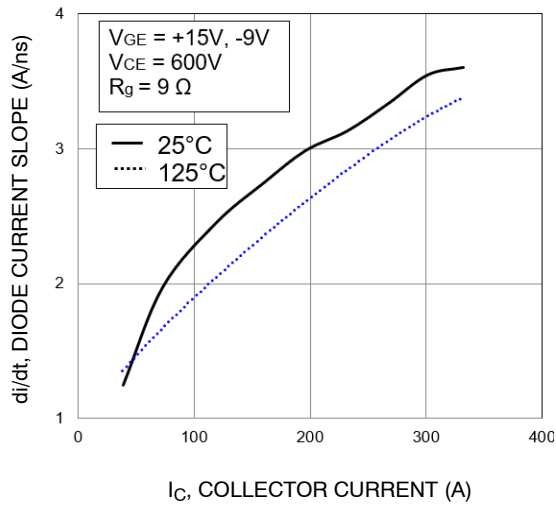

Figure 32. Typical di/dt vs. IC

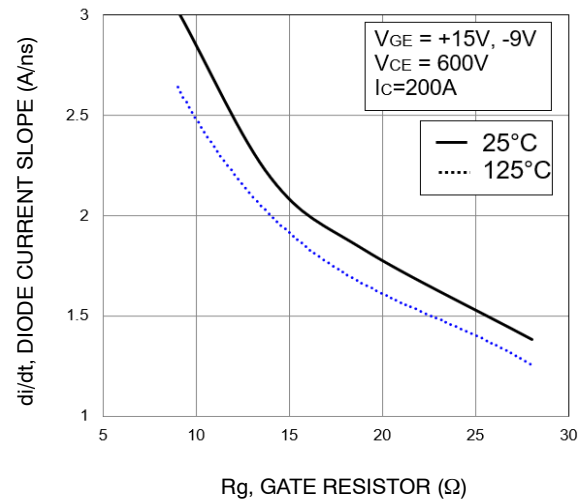

Figure 33. Typical di/dt vs. Rg

TYPICAL CHARACTERISTICS – INVERSE DIODE

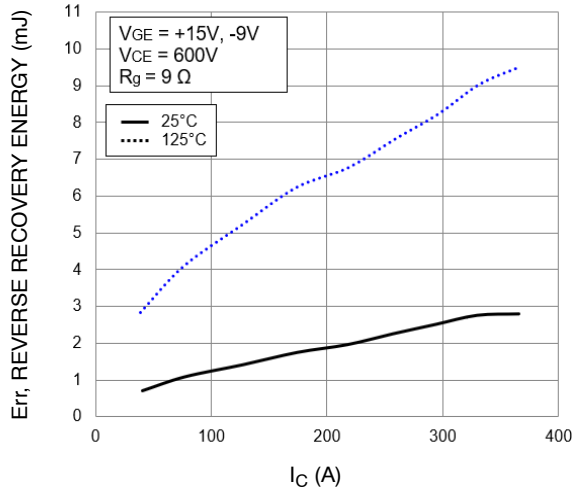

Figure 34. Typical Reverse Recovery Energy Loss vs. IC

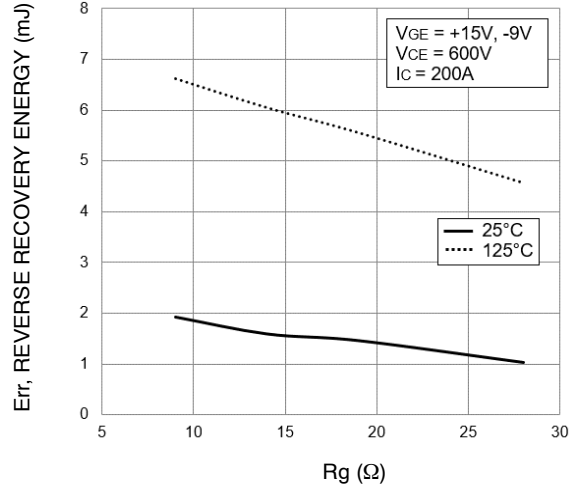

Figure 35. Typical Reverse Recovery Energy Loss vs. Rg

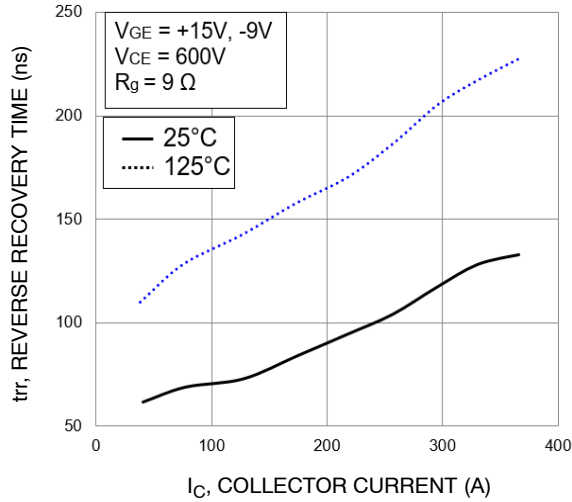

Figure 36. Typical Reverse Recovery Time vs. IC

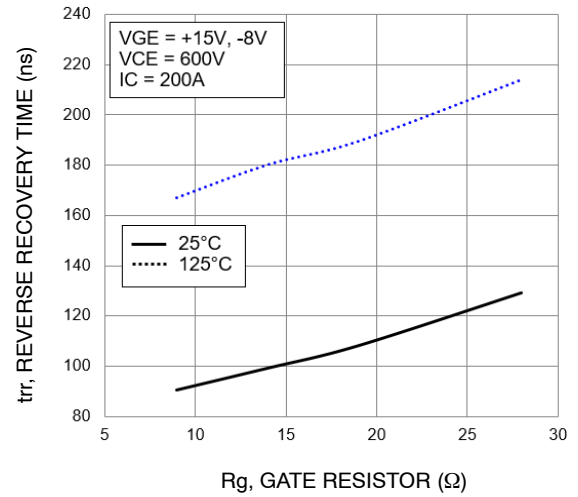

Figure 37. Typical Reverse Recovery Time vs. Rg

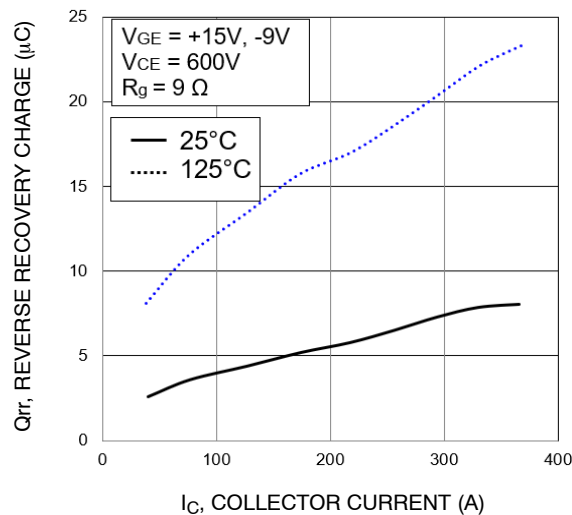

Figure 38. Typical Reverse Recovery Charge vs. IC

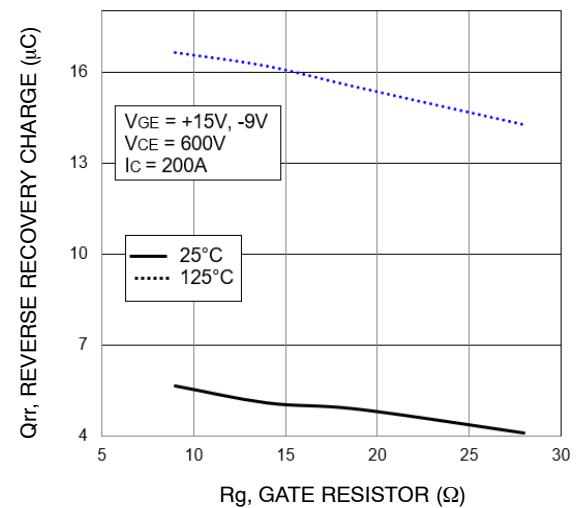

Figure 39. Typical Reverse Recovery Charge vs. Rg

NXH400N100L4Q2F2SG, NXH400N100L4Q2F2PG

TYPICAL CHARACTERISTICS – INVERSE DIODE (continued)

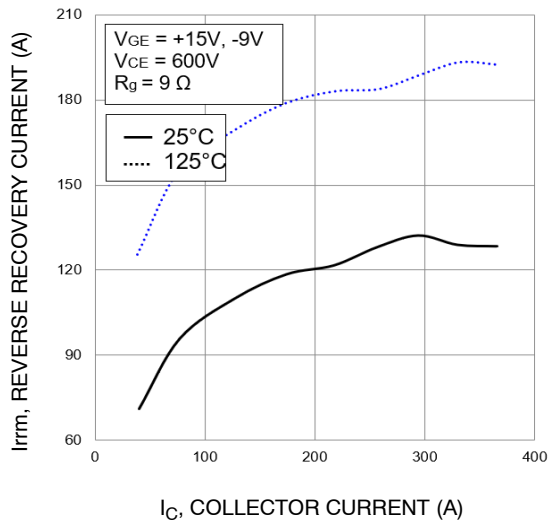

Figure 40. Typical Reverse Recovery Peak Current vs. IC

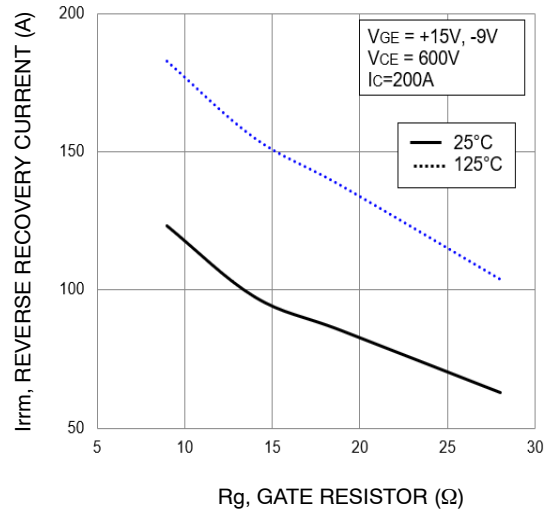

Figure 41. Typical Reverse Recovery Peak Current vs. Rg

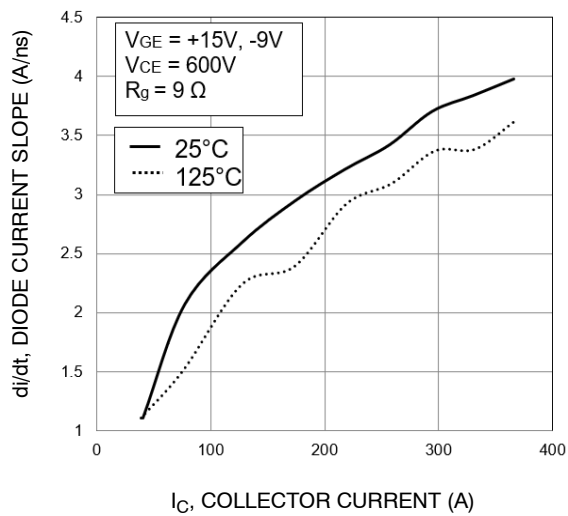

Figure 42. Typical di/dt vs. IC

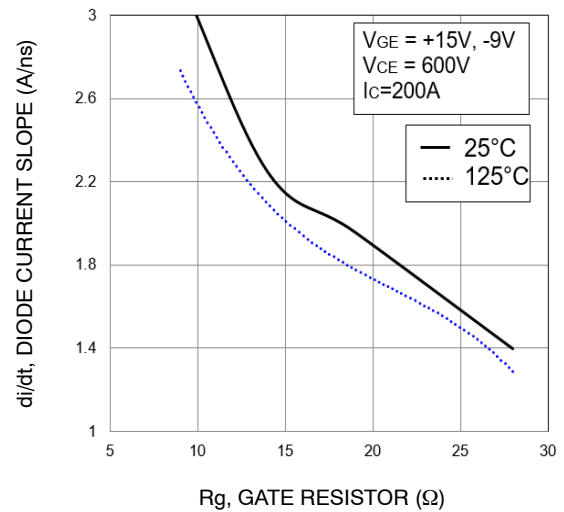

Figure 43. Typical di/dt vs. Rg

TYPICAL CHARACTERISTICS – IGBT, INVERSE DIODE AND NEUTRAL POINT DIODE

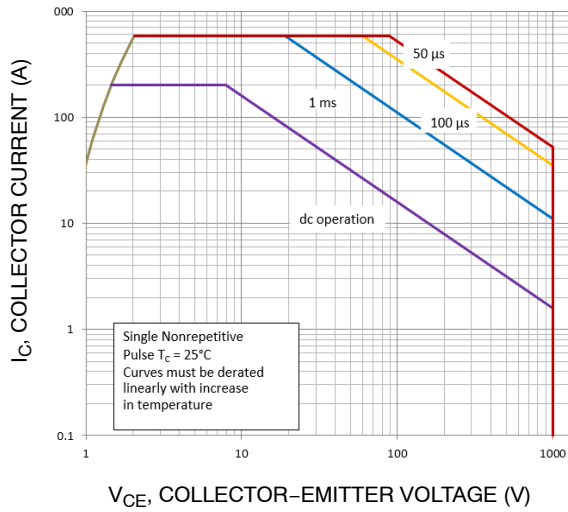

Figure 44. FBSOA – Outer IGBT

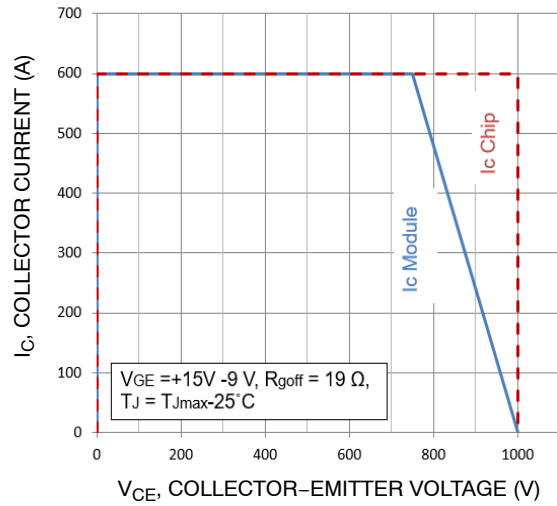

Figure 45. RBSOA – Outer IGBT

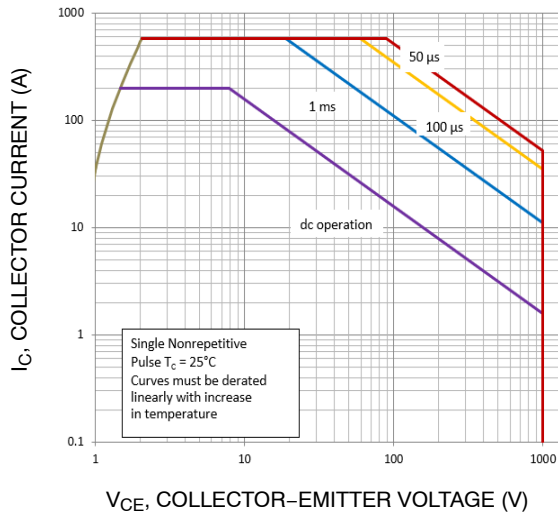

Figure 46. FBSOA – Inner IGBT

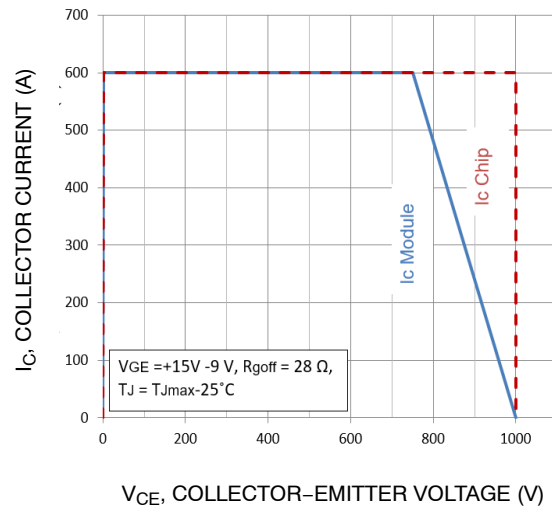

Figure 47. RBSOA – Inner IGBT

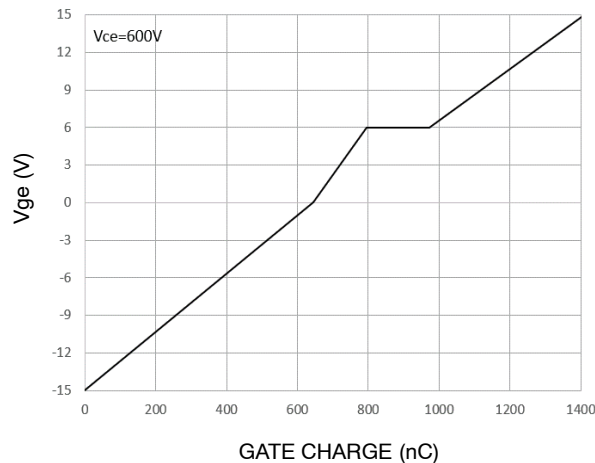

Figure 48. Gate Voltage vs. Gate Charge

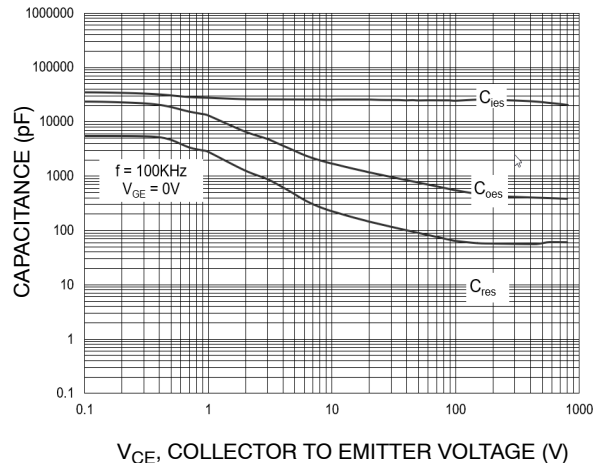

Figure 49. Capacitance Charge

NXH400N100L4Q2F2SG, NXH400N100L4Q2F2PG

TYPICAL CHARACTERISTICS – IGBT, INVERSE DIODE AND NEUTRAL POINT DIODE (continued)

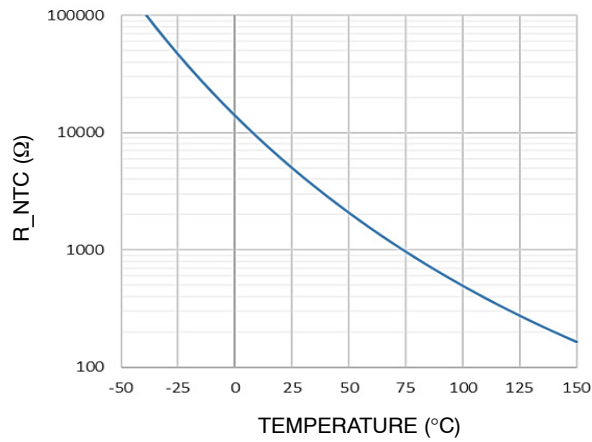

Figure 50. Thermistor Characteristics

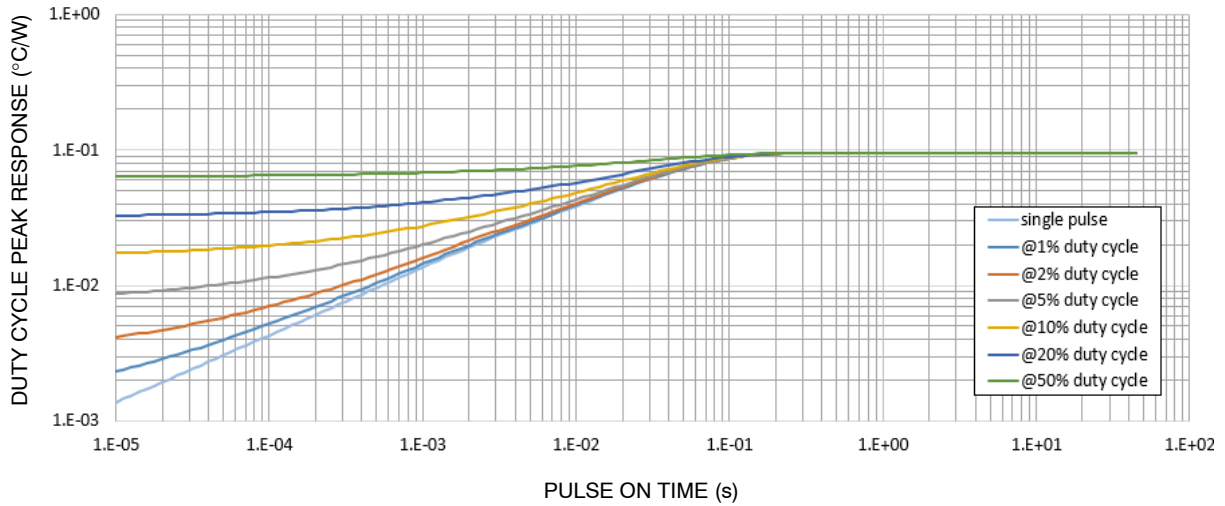

Figure 51. Transient Thermal Impedance – IGBT

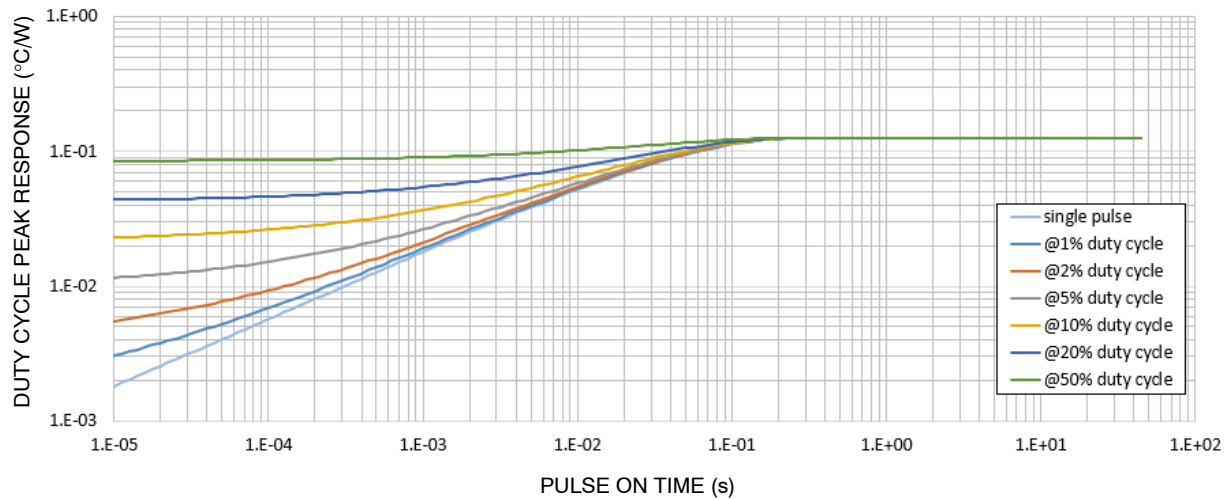

Figure 52. Transient Thermal Impedance – Inverse Diode

NXH400N100L4Q2F2SG, NXH400N100L4Q2F2PG

TYPICAL CHARACTERISTICS – IGBT, INVERSE DIODE AND NEUTRAL POINT DIODE (continued)

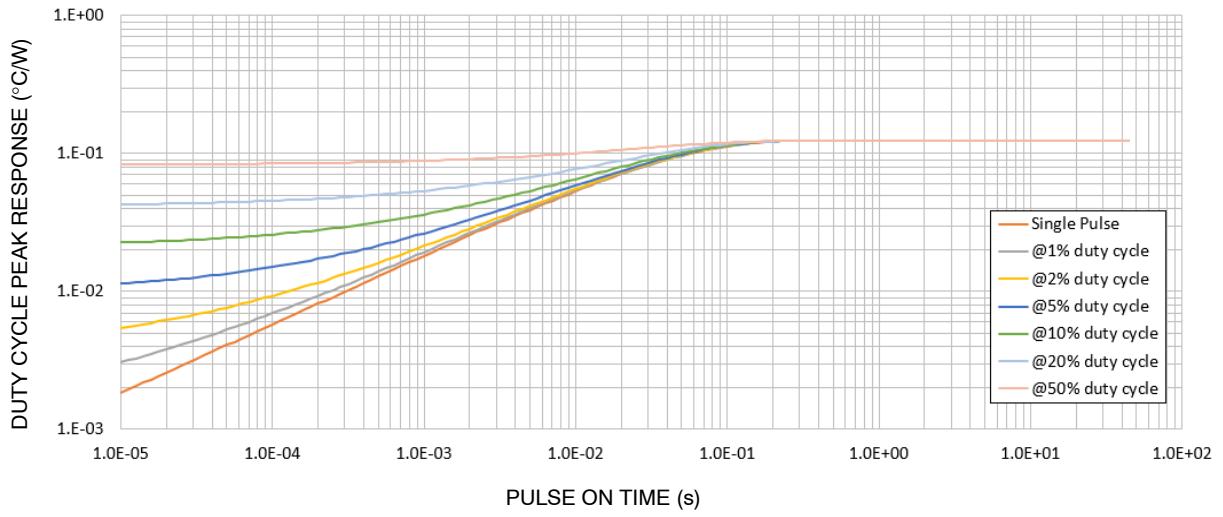
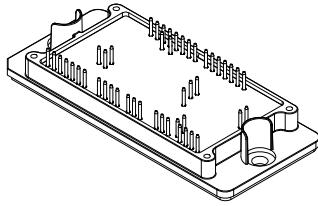

Figure 53. Transient Thermal Impedance – Neutral Point Diode

MECHANICAL CASE OUTLINE

PACKAGE DIMENSIONS



PIM48, 93x47 (SOLDER PIN)
CASE 180BL
ISSUE A

DATE 08 DEC 2022

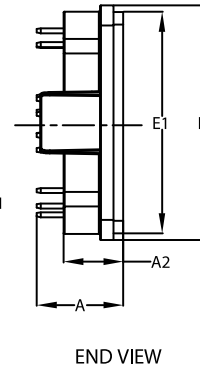
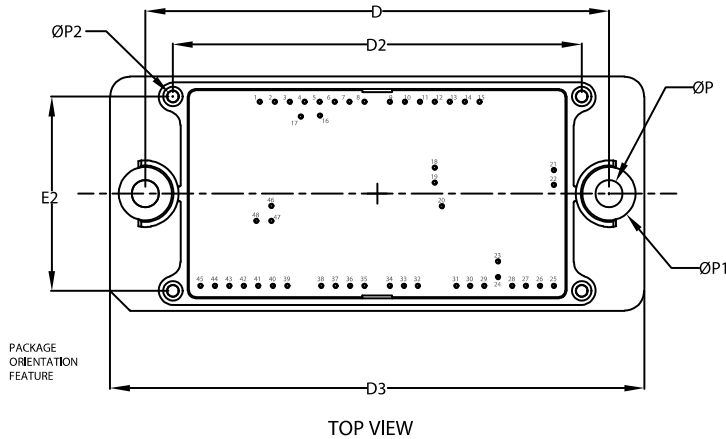
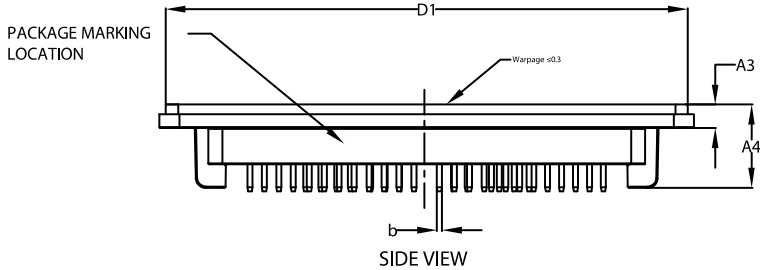

NOTES:

1. DIMENSIONING AND TOLERANCING PER ASME Y14.5M, 2009
2. CONTROLLING DIMENSION : MILLIMETERS
3. DIMENSIONS b AND b1 APPLY TO THE PLATED TERMINALS AND ARE MEASURED AT DIMENSION A1
4. PIN POSITION TOLERANCE IS $\pm 0.4\text{mm}$
5. PACKAGE MARKING IS LOCATED AS SHOWN ON THE SIDE OPPOSITE THE PACKAGE ORIENTATION FEATURES

DIM	MILLIMETERS		
	MIN.	NOM.	MAX.
A	16.80	17.20	17.60
A2	11.70	12.00	12.30
A3	4.40	4.70	5.00
A4	16.40	16.70	17.00
b	0.95	1.00	1.05
D	92.90	93.00	93.10
D1	104.45	104.75	105.05
D2	81.80	82.00	82.20
D3	106.90	107.20	107.50
E	46.70	47.00	47.30
E1	44.10	44.40	44.70
E2	38.80	39.00	39.20
P	5.40	5.50	5.60
P1	10.60	10.70	10.80
P2	1.80	2.00	2.20

S Pin position

Pin table				Pin table			
Pin	X	Y	Function	Pin	X	Y	Function
1	11.9	36.9	Phase1	25	70.9	0	DC-
2	14.9	36.9	Phase1	26	68.1	0	DC-
3	17.9	36.9	Phase1	27	65.3	0	DC-
4	20.9	36.9	Phase1	28	62.5	0	DC-
5	23.9	36.9	Phase1	29	59.7	0	DC-
6	26.9	36.9	Phase1	30	56.9	0	DC-
7	29.9	36.9	Phase1	31	54.1	0	DC-
8	32.9	36.9	Phase1	32	51.3	0	DC-
9	38	36.9	Phase2	33	48.5	0	N2
10	41	36.9	Phase2	34	45.7	0	N2
11	44	36.9	Phase2	35	42.9	0	N1
12	47	36.9	Phase2	36	40.1	0	N1
13	50	36.9	Phase2	37	37.3	0	N1
14	53	36.9	Phase2	38	34.5	0	N1
15	56	36.9	Phase2	39	31.7	0	DC+
16	23.95	34.1	E2	40	28.9	0	DC+
17	20.15	33.9	G2	41	26.1	0	DC+
18	47	23.65	G3	42	23.3	0	DC+
19	47	20.65	E3	43	20.5	0	DC+
20	48.4	15.95	N	44	17.7	0	DC+
21	70.9	23.2	TH1	45	14.9	0	DC+
22	70.9	20.2	TH2	46	12.1	16	P
23	59.7	4.85	G4	47	9.3	13	E1
24	59.7	1.75	E4	48	6.5	13	G1

DOCUMENT NUMBER:	98AON47737H	Electronic versions are uncontrolled except when accessed directly from the Document Repository. Printed versions are uncontrolled except when stamped "CONTROLLED COPY" in red.
DESCRIPTION:	PIM48, 93x47 (SOLDER PIN)	PAGE 1 OF 2

onsemi and ONSEMI are trademarks of Semiconductor Components Industries, LLC dba onsemi or its subsidiaries in the United States and/or other countries. onsemi reserves the right to make changes without further notice to any products herein. onsemi makes no warranty, representation or guarantee regarding the suitability of its products for any particular purpose, nor does onsemi assume any liability arising out of the application or use of any product or circuit, and specifically disclaims any and all liability, including without limitation special, consequential or incidental damages. onsemi does not convey any license under its patent rights nor the rights of others.

PIM48, 93x47 (SOLDER PIN)
CASE 180BL
ISSUE A

DATE 08 DEC 2022

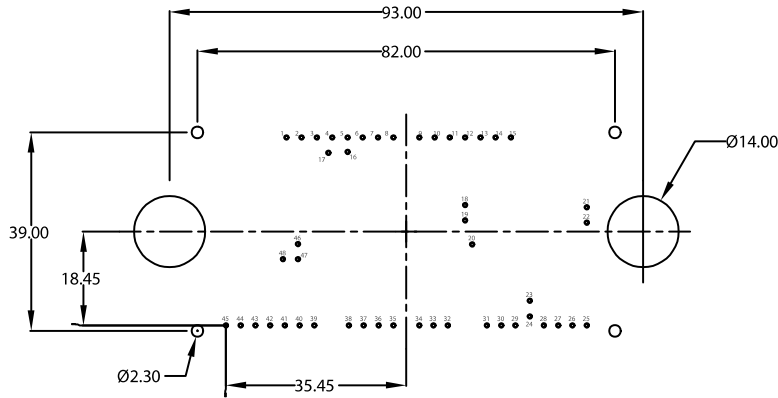

RECOMMENDED
MOUNTING PATTERN

* For additional information on our Pb-Free strategy and soldering details, please download the ON Semiconductor Soldering and Mounting Techniques Reference Manual, SOLDERRM/D.

**GENERIC
MARKING DIAGRAM***

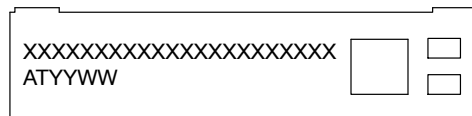

FRONTSIDE MARKING

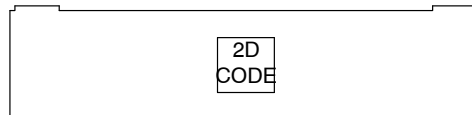

BACKSIDE MARKING

XXXXX = Specific Device Code
AT = Assembly & Test Site Code
YYWW = Year and Work Week Code

*This information is generic. Please refer to device data sheet for actual part marking. Pb-Free indicator, "G" or microdot "▪", may or may not be present. Some products may not follow the Generic Marking.

DOCUMENT NUMBER:	98AON47737H	Electronic versions are uncontrolled except when accessed directly from the Document Repository. Printed versions are uncontrolled except when stamped "CONTROLLED COPY" in red.
DESCRIPTION:	PIM48, 93x47 (SOLDER PIN)	PAGE 2 OF 2

onsemi and ONSEMI are trademarks of Semiconductor Components Industries, LLC dba onsemi or its subsidiaries in the United States and/or other countries. onsemi reserves the right to make changes without further notice to any products herein. onsemi makes no warranty, representation or guarantee regarding the suitability of its products for any particular purpose, nor does onsemi assume any liability arising out of the application or use of any product or circuit, and specifically disclaims any and all liability, including without limitation special, consequential or incidental damages. onsemi does not convey any license under its patent rights nor the rights of others.

MECHANICAL CASE OUTLINE

PACKAGE DIMENSIONS

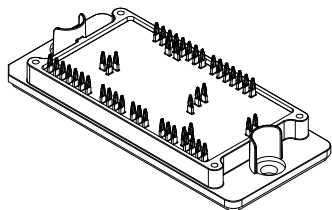

PIM48, 93x47 (PRESS-FIT PIN) CASE 180CR ISSUE A

DATE 08 DEC 2022

PACKAGE MARKING LOCATION

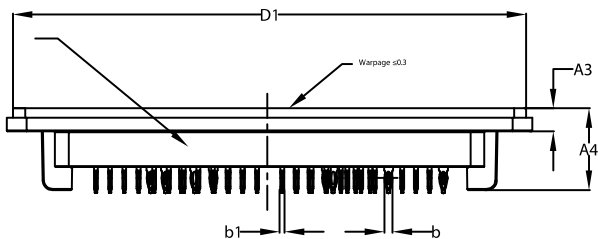

SIDE VIEW

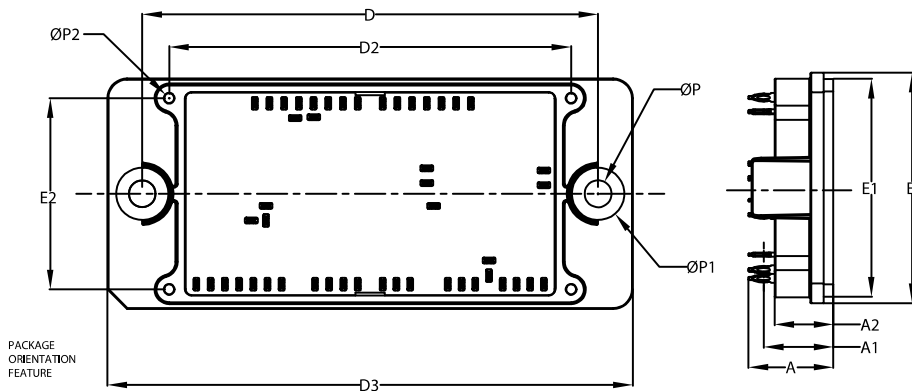

TOP VIEW

END VIEW

S Pin position

Pin table				Pin table			
Pin	X	Y	Function	Pin	X	Y	Function
1	11.9	36.9	Phase1	25	70.9	0	DC-
2	14.9	36.9	Phase1	26	68.1	0	DC-
3	17.9	36.9	Phase1	27	65.3	0	DC-
4	20.9	36.9	Phase1	28	62.5	0	DC-
5	23.9	36.9	Phase1	29	59.7	0	DC-
6	26.9	36.9	Phase1	30	56.9	0	DC-
7	29.9	36.9	Phase1	31	54.1	0	DC-
8	32.9	36.9	Phase1	32	51.3	0	DC-
9	38	36.9	Phase2	33	48.5	0	N2
10	41	36.9	Phase2	34	45.7	0	N2
11	44	36.9	Phase2	35	42.9	0	N1
12	47	36.9	Phase2	36	40.1	0	N1
13	50	36.9	Phase2	37	37.3	0	N1
14	53	36.9	Phase2	38	34.5	0	N1
15	56	36.9	Phase2	39	31.7	0	DC+
16	23.95	34.1	E2	40	28.9	0	DC+
17	20.15	33.9	G2	41	26.1	0	DC+
18	47	23.65	G3	42	23.3	0	DC+
19	47	20.65	E3	43	20.5	0	DC+
20	48.4	15.95	N	44	17.7	0	DC+
21	70.9	23.2	TH1	45	14.9	0	DC+
22	70.9	20.2	TH2	46	12.1	16	P
23	59.7	4.85	G4	47	9.3	13	E1
24	59.7	1.75	E4	48	6.5	13	G1

NOTES:

1. DIMENSIONING AND TOLERANCING PER ASME Y14.5M, 2009
2. CONTROLLING DIMENSION: MILLIMETERS
3. DIMENSIONS b AND b1 APPLY TO THE PLATED TERMINALS AND ARE MEASURED AT DIMENSION A1
4. PIN POSITION TOLERANCE IS ± 0.4mm
5. PACKAGE MARKING IS LOCATED AS SHOWN ON THE SIDE OPPOSITE THE PACKAGE ORIENTATION FEATURES

DIM	MILLIMETERS		
	MIN.	NOM.	MAX.
A	16.90	17.30	17.70
A1	13.97	14.18	14.39
A2	11.70	12.00	12.30
A3	4.40	4.70	5.00
A4	16.40	16.70	17.00
b	1.61	1.66	1.71
b1	0.75	0.80	0.85
D	92.90	93.00	93.10
D1	104.45	104.75	105.05
D2	81.80	82.00	82.20
D3	106.90	107.20	107.50
E	46.70	47.00	47.30
E1	44.10	44.40	44.70
E2	38.80	39.00	39.20
P	5.40	5.50	5.60
P1	10.60	10.70	10.80
P2	1.80	2.00	2.20

DOCUMENT NUMBER:	98AON47745H	Electronic versions are uncontrolled except when accessed directly from the Document Repository. Printed versions are uncontrolled except when stamped "CONTROLLED COPY" in red.
DESCRIPTION:	PIM48, 93x47 (PRESS-FIT PIN)	PAGE 1 OF 2

onsemi and **ONSEMI** are trademarks of Semiconductor Components Industries, LLC dba **onsemi** or its subsidiaries in the United States and/or other countries. **onsemi** reserves the right to make changes without further notice to any products herein. **onsemi** makes no warranty, representation or guarantee regarding the suitability of its products for any particular purpose, nor does **onsemi** assume any liability arising out of the application or use of any product or circuit, and specifically disclaims any and all liability, including without limitation special, consequential or incidental damages. **onsemi** does not convey any license under its patent rights nor the rights of others.

PIM48, 93x47 (PRESS-FIT PIN)
CASE 180CR
ISSUE A

DATE 08 DEC 2022

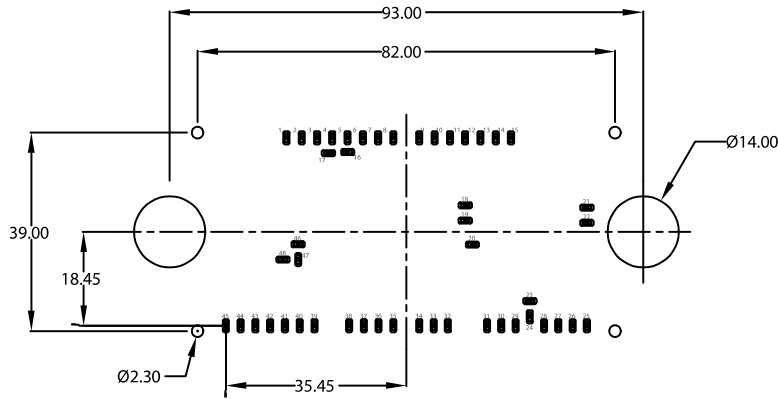

RECOMMENDED
MOUNTING PATTERN

* For additional information on our Pb-Free strategy and soldering details, please download the ON Semiconductor Soldering and Mounting Techniques Reference Manual, SOLDERRM/D.

**GENERIC
MARKING DIAGRAM***

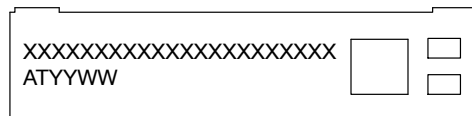

FRONTSIDE MARKING

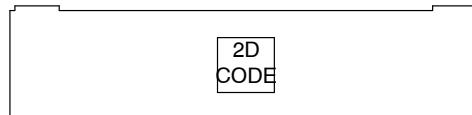

BACKSIDE MARKING

XXXXX = Specific Device Code
AT = Assembly & Test Site Code
YYWW = Year and Work Week Code

*This information is generic. Please refer to device data sheet for actual part marking. Pb-Free indicator, "G" or microdot "▪", may or may not be present. Some products may not follow the Generic Marking.

DOCUMENT NUMBER:	98AON47745H	Electronic versions are uncontrolled except when accessed directly from the Document Repository. Printed versions are uncontrolled except when stamped "CONTROLLED COPY" in red.
DESCRIPTION:	PIM48, 93x47 (PRESS-FIT PIN)	PAGE 2 OF 2

onsemi and ONSEMI are trademarks of Semiconductor Components Industries, LLC dba onsemi or its subsidiaries in the United States and/or other countries. onsemi reserves the right to make changes without further notice to any products herein. onsemi makes no warranty, representation or guarantee regarding the suitability of its products for any particular purpose, nor does onsemi assume any liability arising out of the application or use of any product or circuit, and specifically disclaims any and all liability, including without limitation special, consequential or incidental damages. onsemi does not convey any license under its patent rights nor the rights of others.

onsemi, **Onsemi**, and other names, marks, and brands are registered and/or common law trademarks of Semiconductor Components Industries, LLC dba "**onsemi**" or its affiliates and/or subsidiaries in the United States and/or other countries. **onsemi** owns the rights to a number of patents, trademarks, copyrights, trade secrets, and other intellectual property. A listing of **onsemi**'s product/patent coverage may be accessed at www.onsemi.com/site/pdf/Patent-Marking.pdf. **onsemi** reserves the right to make changes at any time to any products or information herein, without notice. The information herein is provided "as-is" and **onsemi** makes no warranty, representation or guarantee regarding the accuracy of the information, product features, availability, functionality, or suitability of its products for any particular purpose, nor does **onsemi** assume any liability arising out of the application or use of any product or circuit, and specifically disclaims any and all liability, including without limitation special, consequential or incidental damages. Buyer is responsible for its products and applications using **onsemi** products, including compliance with all laws, regulations and safety requirements or standards, regardless of any support or applications information provided by **onsemi**. "Typical" parameters which may be provided in **onsemi** data sheets and/or specifications can and do vary in different applications and actual performance may vary over time. All operating parameters, including "Typicals" must be validated for each customer application by customer's technical experts. **onsemi** does not convey any license under any of its intellectual property rights nor the rights of others. **onsemi** products are not designed, intended, or authorized for use as a critical component in life support systems or any FDA Class 3 medical devices or medical devices with a same or similar classification in a foreign jurisdiction or any devices intended for implantation in the human body. Should Buyer purchase or use **onsemi** products for any such unintended or unauthorized application, Buyer shall indemnify and hold **onsemi** and its officers, employees, subsidiaries, affiliates, and distributors harmless against all claims, costs, damages, and expenses, and reasonable attorney fees arising out of, directly or indirectly, any claim of personal injury or death associated with such unintended or unauthorized use, even if such claim alleges that **onsemi** was negligent regarding the design or manufacture of the part. **onsemi** is an Equal Opportunity/Affirmative Action Employer. This literature is subject to all applicable copyright laws and is not for resale in any manner.

ADDITIONAL INFORMATION

TECHNICAL PUBLICATIONS:

Technical Library: www.onsemi.com/design/resources/technical-documentation
onsemi Website: www.onsemi.com

ONLINE SUPPORT: www.onsemi.com/support

For additional information, please contact your local Sales Representative at www.onsemi.com/support/sales