

STELLA-A

Type II and III beam for street lighting.
Compatible with up to 23 mm LES size COBs.
Variant with black frame.

SPECIFICATION:

Dimensions	Ø 90.0 mm
Height	22 mm
Fastening	screw
Ingress protection classes	IP67
ROHS compliant	yes ⓘ



MATERIALS:

Component	Type	Material	Colour	Finish
STELLA-A	Single lens	Silicone	clear	
STELLA-FRAME	Holder	PA66	black	





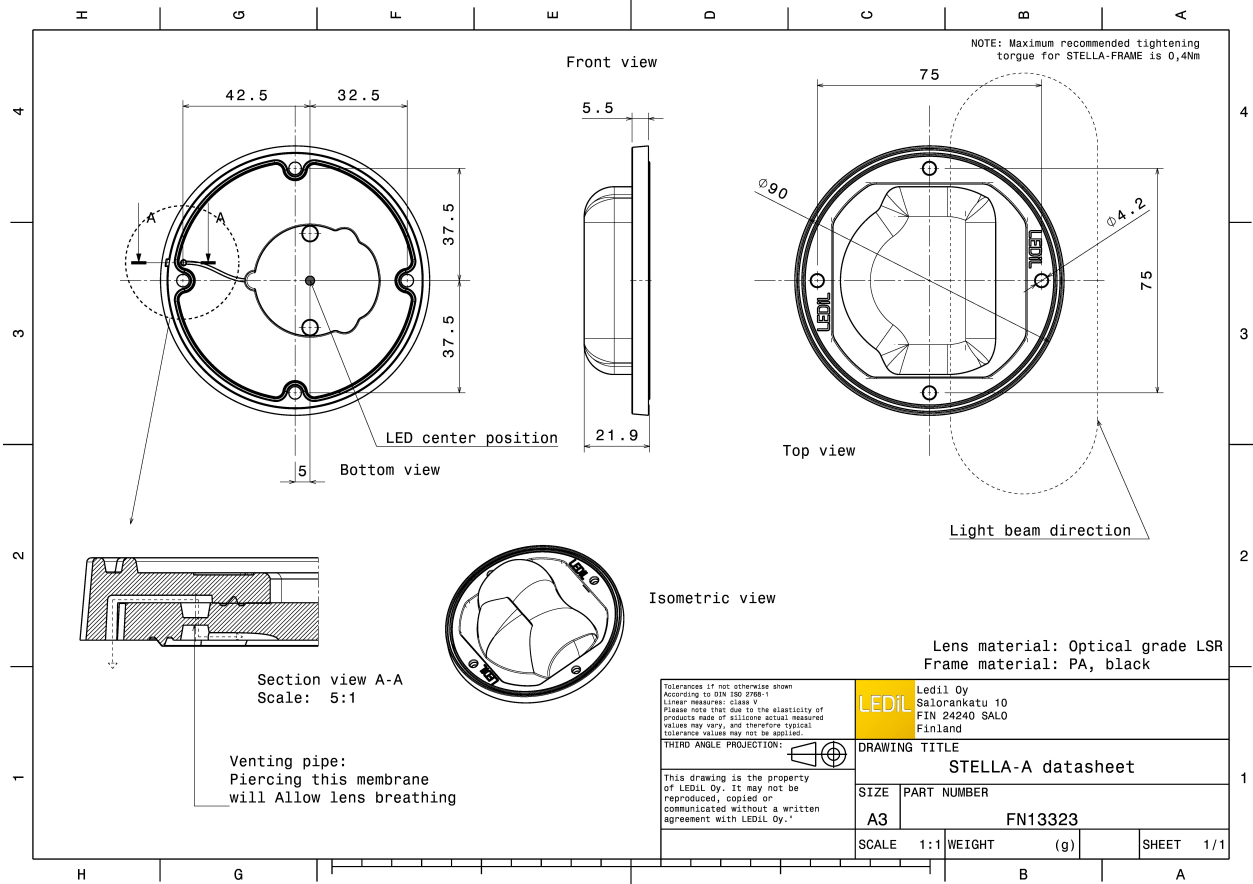

ORDERING INFORMATION:

Component		Qty in box	MOQ	MPQ	Box weight (kg)
FN13323_STELLA-A	Single lens	100	50	10	6.6
» Box size:					

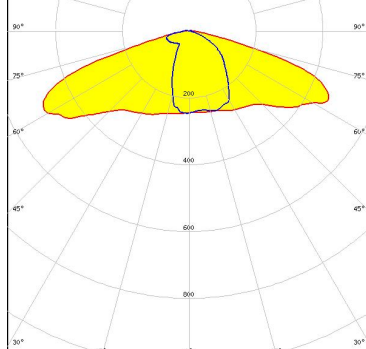

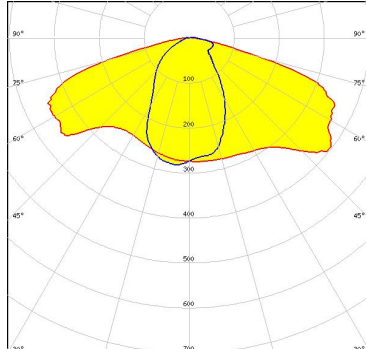
See also our general installation guide: www.ledil.com/installation_guide

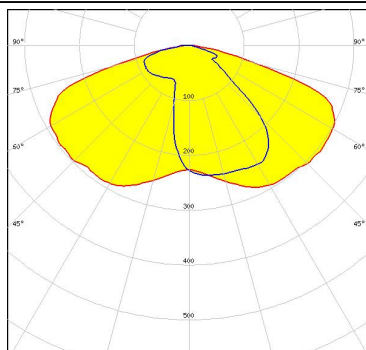
OPTICAL RESULTS (MEASURED):

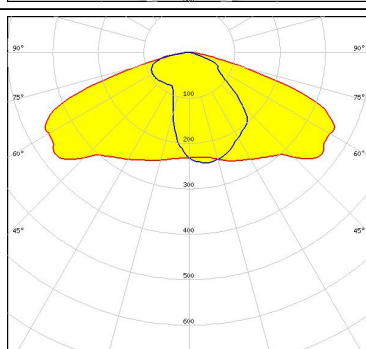
<p></p> <p>LED V15 Gen6 FWHM / FWTM Asymmetric Efficiency 91 % Peak intensity 0.6 cd/lm LEDs/each optic 1 Light colour White Required components:</p>	
<p></p> <p>LED V18 Gen7 FWHM / FWTM Asymmetric Efficiency 85 % Peak intensity 0.4 cd/lm LEDs/each optic 1 Light colour White Required components:</p>	
<p></p> <p>LED VERO13 FWHM / FWTM Asymmetric Efficiency 92 % Peak intensity 0.7 cd/lm LEDs/each optic 1 Light colour White Required components:</p>	
<p></p> <p>LED VERO18 FWHM / FWTM Asymmetric Efficiency 92 % Peak intensity 0.5 cd/lm LEDs/each optic 1 Light colour White Required components:</p>	

OPTICAL RESULTS (MEASURED):

CITIZEN

LED CLL03x/CLU03x
 FWHM / FWTM Asymmetric
 Efficiency 92 %
 Peak intensity 0.6 cd/lm
 LEDs/each optic 1
 Light colour White
 Required components:
 Bender Wirth: 433 Typ L1

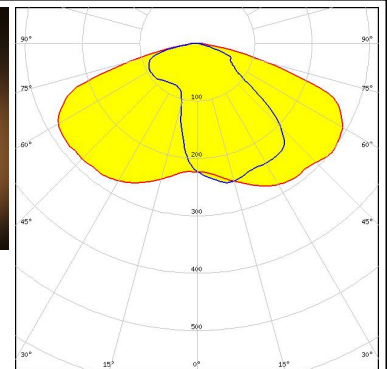
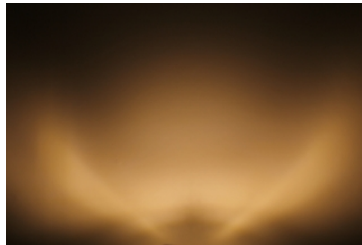

CITIZEN

LED CLU700/701/702/703
 FWHM / FWTM Asymmetric
 Efficiency 89 %
 Peak intensity 1.4 cd/lm
 LEDs/each optic 1
 Light colour White
 Required components:
 Bender Wirth: 434 Typ L1

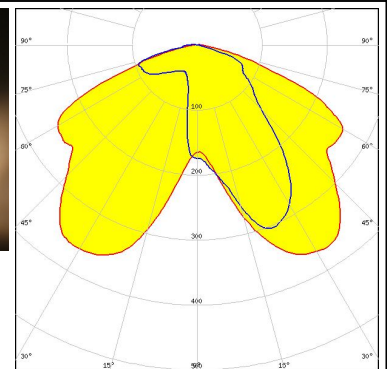
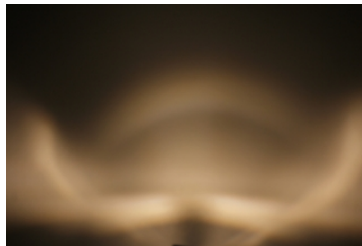

CITIZEN

LED CLU710/711
 FWHM / FWTM Asymmetric
 Efficiency 89 %
 Peak intensity 1 cd/lm
 LEDs/each optic 1
 Light colour White
 Required components:

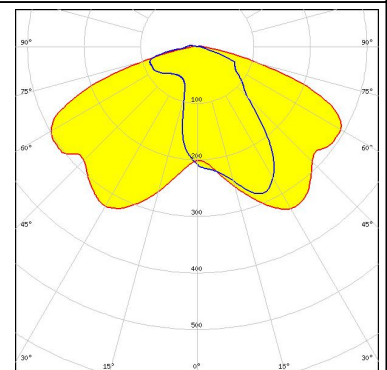

CITIZEN

LED CLU720/721/723
 FWHM / FWTM Asymmetric
 Efficiency %
 Peak intensity 0.7 cd/lm
 LEDs/each optic 1
 Light colour White
 Required components:

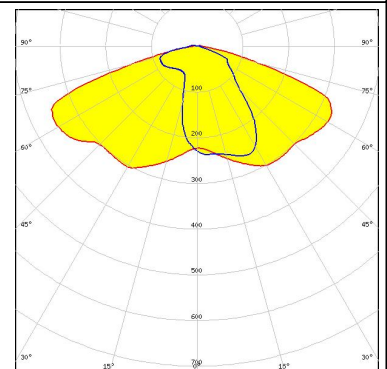

OPTICAL RESULTS (MEASURED):

CITIZEN

LED CLU720/721/723
 FWHM / FWTM Asymmetric
 Efficiency 91 %
 Peak intensity 0.8 cd/lm
 LEDs/each optic 1
 Light colour White
 Required components:
 Bender Wirth: 433 Typ L1

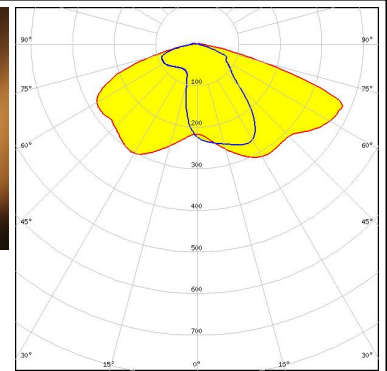
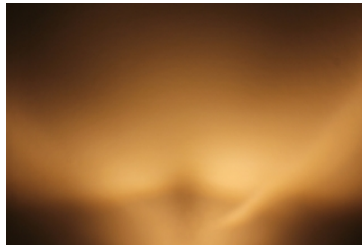

CREE LED

LED CXA/B 15xx
 FWHM / FWTM Asymmetric
 Efficiency 92 %
 Peak intensity 0.9 cd/lm
 LEDs/each optic 1
 Light colour White
 Required components:
 Bender Wirth: 441 Typ L1

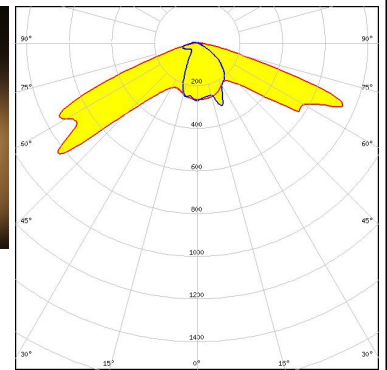
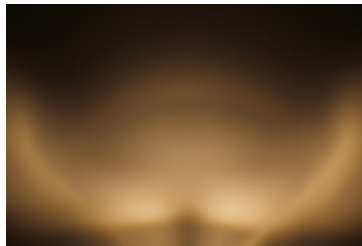

CREE LED

LED CXA/B 15xx
 FWHM / FWTM Asymmetric
 Efficiency 92 %
 Peak intensity 1.1 cd/lm
 LEDs/each optic 1
 Light colour White
 Required components:

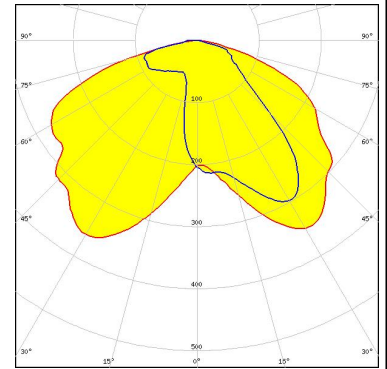

CREE LED

LED CXA/B 15xx
 FWHM / FWTM Asymmetric
 Efficiency 89 %
 Peak intensity 1 cd/lm
 LEDs/each optic 1
 Light colour White
 Required components:
 C14305_STELLA-CLAMP-CXA15-18

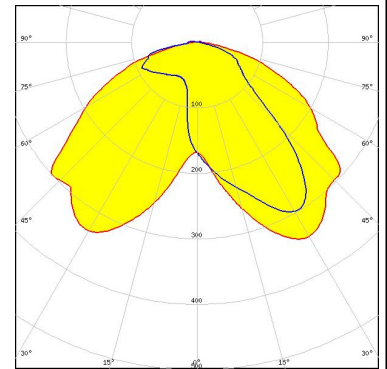

OPTICAL RESULTS (MEASURED):

CREE LED

LED CXA/B 1816 & CXA/B 1820 & CXA 1850
 FWHM / FWTM Asymmetric
 Efficiency 89 %
 Peak intensity 0.7 cd/lm
 LEDs/each optic 1
 Light colour White
 Required components:
 Bender Wirth: 437 Typ L1

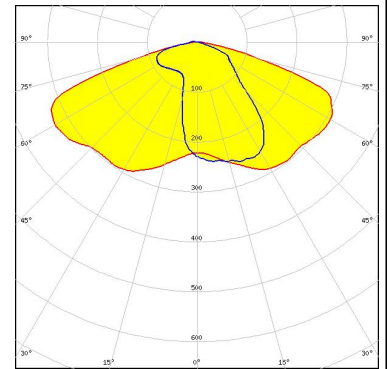

CREE LED

LED CXA/B 1816 & CXA/B 1820 & CXA 1850
 FWHM / FWTM Asymmetric
 Efficiency 92 %
 Peak intensity 0.7 cd/lm
 LEDs/each optic 1
 Light colour White
 Required components:
 C14305_STELLA-CLAMP-CXA15-18

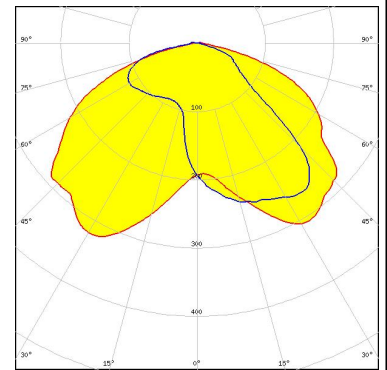

CREE LED

LED CXA/B 1816 & CXA/B 1820 & CXA 1850
 FWHM / FWTM Asymmetric
 Efficiency 87 %
 Peak intensity 0.7 cd/lm
 LEDs/each optic 1
 Light colour White
 Required components:

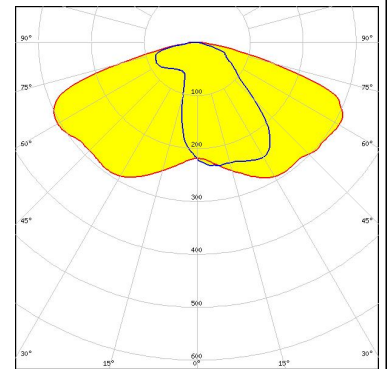

CREE LED

LED CXA/B 1816 & CXA/B 1820 & CXA 1850
 FWHM / FWTM Asymmetric
 Efficiency 87 %
 Peak intensity 0.6 cd/lm
 LEDs/each optic 1
 Light colour White
 Required components:

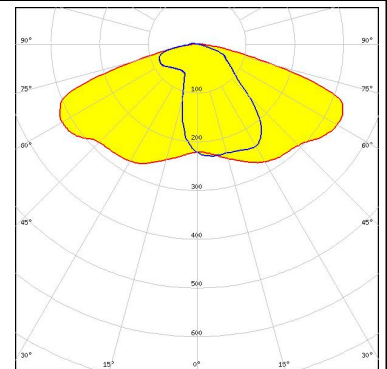

OPTICAL RESULTS (MEASURED):



LED CXA/B 25xx
 FWHM / FWTM Asymmetric
 Efficiency 93 %
 Peak intensity 0.5 cd/lm
 LEDs/each optic 1
 Light colour White
 Required components:

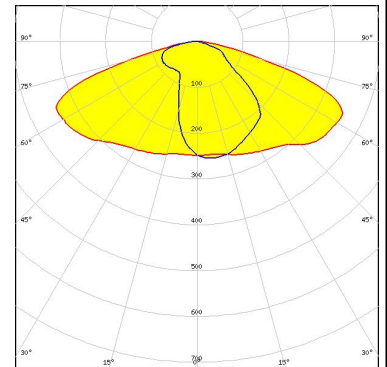

LED LUXEON CoB 1202/1203
 FWHM / FWTM Asymmetric
 Efficiency 88 %
 Peak intensity 0.9 cd/lm
 LEDs/each optic 1
 Light colour White
 Required components:
 Bender Wirth: 438 Typ L1

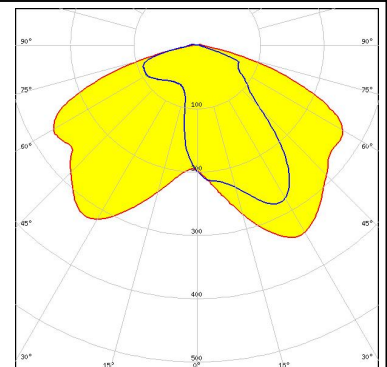

LED LUXEON CoB 1208
 FWHM / FWTM Asymmetric
 Efficiency %
 Peak intensity 0.3 cd/lm
 LEDs/each optic 1
 Light colour White
 Required components:

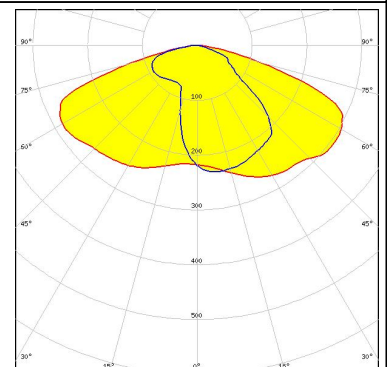

LED CxM-14 (19x19)
 FWHM / FWTM Asymmetric
 Efficiency 90 %
 Peak intensity 0.6 cd/lm
 LEDs/each optic 1
 Light colour White
 Required components:

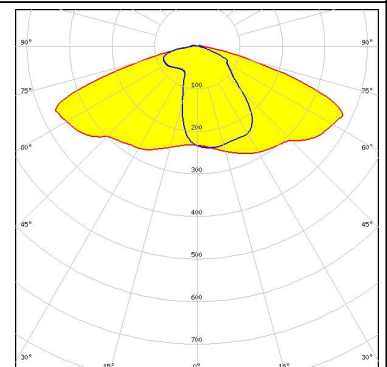

OPTICAL RESULTS (MEASURED):



LED CxM-18 (21.5x21.5)
 FWHM / FWTM Asymmetric
 Efficiency 89 %
 Peak intensity 0.5 cd/lm
 LEDs/each optic 1
 Light colour White
 Required components:

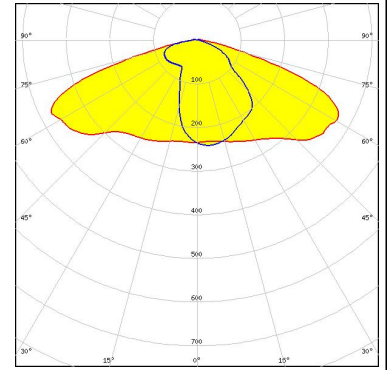

LED COB J-Type
 FWHM / FWTM Asymmetric
 Efficiency 87 %
 Peak intensity 0.5 cd/lm
 LEDs/each optic 1
 Light colour White
 Required components:

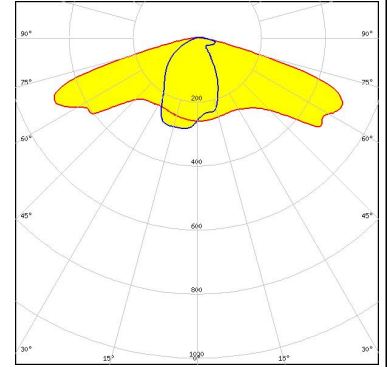

LED COB L-Type (LES 11)
 FWHM / FWTM Asymmetric
 Efficiency 89 %
 Peak intensity 0.7 cd/lm
 LEDs/each optic 1
 Light colour White
 Required components:
 Bender Wirth: 438 Typ L1

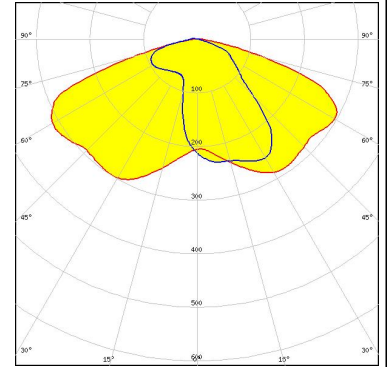

LED COB L-Type (LES 9)
 FWHM / FWTM Asymmetric
 Efficiency 90 %
 Peak intensity 0.9 cd/lm
 LEDs/each optic 1
 Light colour White
 Required components:
 Bender Wirth: 438 Typ L1

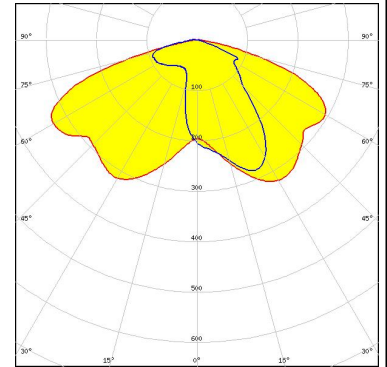

OPTICAL RESULTS (MEASURED):

OSRAM

Opto Semiconductors

LED Soleriq S13
 FWHM / FWTM Asymmetric
 Efficiency 91 %
 Peak intensity 0.7 cd/lm
 LEDs/each optic 1
 Light colour White
 Required components:

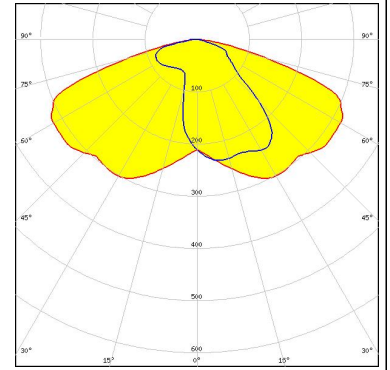

OSRAM

Opto Semiconductors

LED Soleriq S13
 FWHM / FWTM Asymmetric
 Efficiency 92 %
 Peak intensity 0.7 cd/lm
 LEDs/each optic 1
 Light colour White
 Required components:
 Bender Wirth: 437 Typ L1

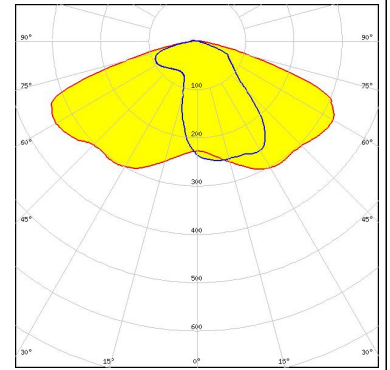

OSRAM

Opto Semiconductors

LED Soleriq S19
 FWHM / FWTM Asymmetric
 Efficiency 90 %
 Peak intensity 0.5 cd/lm
 LEDs/each optic 1
 Light colour White
 Required components:

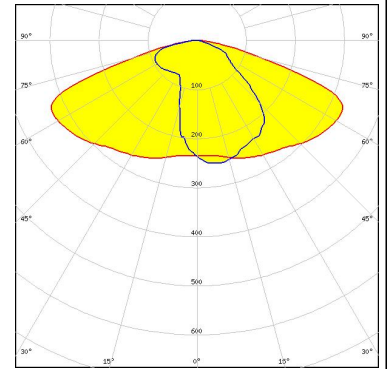

SAMSUNG

LED LC016D / LC019D / LC026D / LC033D
 FWHM / FWTM Asymmetric
 Efficiency 87 %
 Peak intensity 0.5 cd/lm
 LEDs/each optic 1
 Light colour White
 Required components:

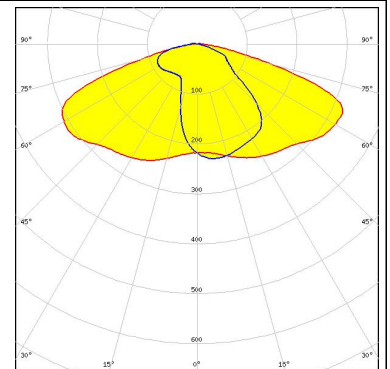

OPTICAL RESULTS (MEASURED):

SHARP

LED Mega Zenigata (GW6DME)
FWHM / FWTM Asymmetric
Efficiency 90 %
Peak intensity 0.6 cd/lm
LEDs/each optic 1
Light colour White
Required components:

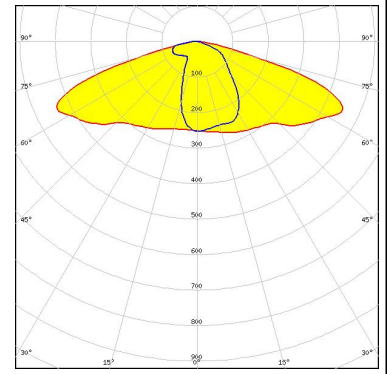

OPTICAL RESULTS (SIMULATED):

bridgelux.

LED V10 Gen7
 FWHM / FWTM Asymmetric
 Efficiency 89 %
 Peak intensity 0.6 cd/lm
 LEDs/each optic 1
 Light colour White
 Required components:
 Bender Wirth: 486 Typ L1

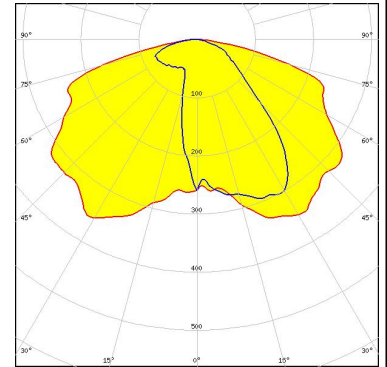

bridgelux.

LED V13 Gen7
 FWHM / FWTM Asymmetric
 Efficiency 89 %
 Peak intensity 0.6 cd/lm
 LEDs/each optic 1
 Light colour White
 Required components:
 Bender Wirth: 477 Typ L1

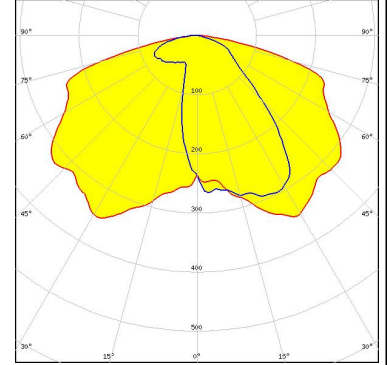

CITIZEN

LED CLL02x/CLU02x (LES10)
 FWHM / FWTM Asymmetric
 Efficiency 85 %
 Peak intensity 0.6 cd/lm
 LEDs/each optic 1
 Light colour White
 Required components:

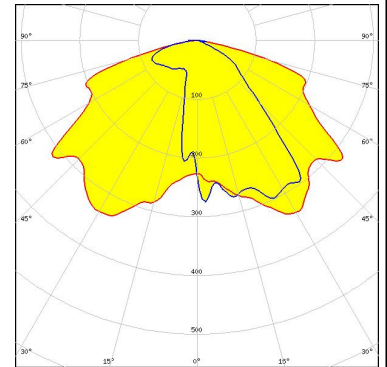

CITIZEN

LED CLL04x/CLU04x
 FWHM / FWTM Asymmetric
 Efficiency 83 %
 Peak intensity 0.3 cd/lm
 LEDs/each optic 1
 Light colour White
 Required components:

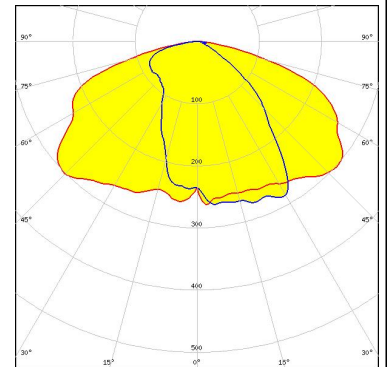

GENERAL INFORMATION:

NOTE: The typical beam angle will be changed by different color, chip size and chip position tolerance. The typical total beam angle is the full angle measured where the luminous intensity is half of the peak value.

Due to use of high power COB's with this product, special attention to proper thermal design is highly recommended. LEDiL has no liability for direct, indirect or consecutive damages arising from the LEDiL products being used outside of the recommended temperature range.

MATERIALS:

As part of our continuous research and improvement processes, and to ensure the best possible quality and availability of our products, LEDiL reserves the right to change material grades without notice.

PRODUCT DATA USER AGREEMENT AND DISCLAIMER:

The measured data in the provided downloadable LEDiL Product Datasheets and Mechanical 2D-Drawings is rounded and provided as reference for planning. LEDiL Oy's optical specifications have been verified by conducting performance testing of the products in accordance with the company's quality system. The reported data are averaged results of multiple measurements with typical variation. LEDiL Oy reserves the right to without prior notification make changes and improvements to its products.

LEDiL Oy assumes neither warranty, nor guarantee nor any other liability of any kind for the contents and correctness of the provided data. The provided data has been generated with highest diligence but the provided data may in reality not represent the complete possible variation range of all intrinsic parameters. Therefore, in certain cases a deviation from the provided data could occur.

LEDiL Oy reserves the right to undertake technical changes of its products without further notification which could lead to changes in the provided data. LEDiL Oy assumes no liability of any kind for the possible deviation from any provided data or any other damage resulting from the usage of the provided data.

The user agrees to this disclaimer and user agreement with the download or usage of the provided files.

LEDiL Oy

Joensuunkatu 13
FI-24240 SALO
Finland

LEDiL Inc.

228 West Page Street
Suite D
Sycamore IL 60178
USA

Ledil Optics Technology (Shenzhen) Co., Ltd.

405 , Block B
Casic Motor Building
Shenzhen 518057
P.R.CHINA

Local sales and technical support

[www.ledil.com/
where_to_buy](http://www.ledil.com/where_to_buy)

Shipping locations

Salo, Finland
Hong Kong, China

Distribution Partners

[www.ledil.com/
where_to_buy](http://www.ledil.com/where_to_buy)