



Part Number: D4C1213

Electrical Specifications

Frequency Range (GHz):	11.7 – 12.7
Isolation (dB):	23 MIN (per junction)
Insertion Loss (dB):	0.3 MAX (per junction)
VSWR:	1.2:1 MIN
Forward Power (W):	10 AVG 30 PK

Mechanical/Environmental Specifications

Connector Type:	SMA
Connector Body:	Passivated stainless steel
Connector Pin:	Gold plated copper
Load Body:	Brass
Magnetic Shunt:	Nickel plated CRS
Operational Temp:	-30°C to +65°C
Weight (oz)	2.0 MAX

D4C1213 Dimensions

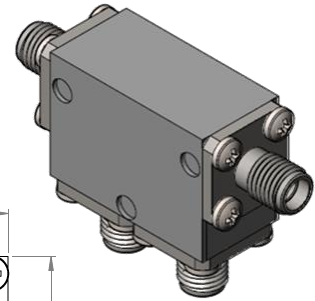
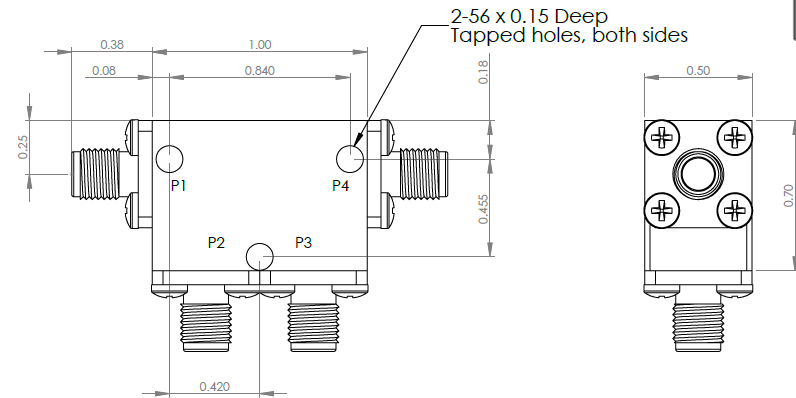

D4C1213-3 Dimensions

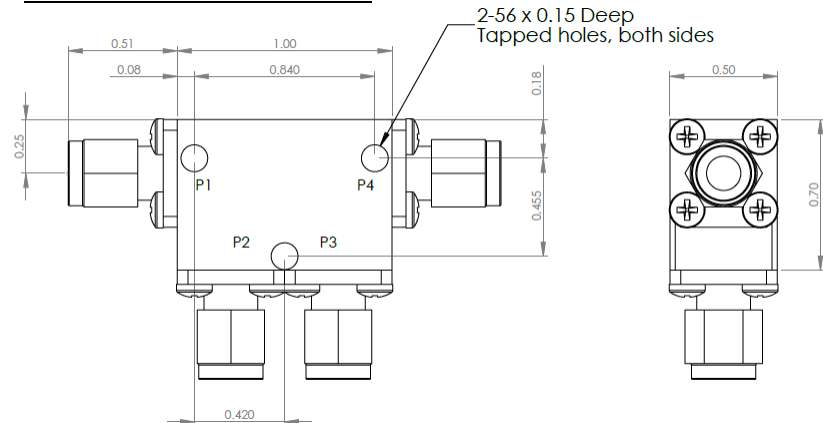

Dimensions are in inches
Tolerance

XX	±0.03
XXX	±0.010

Type of Device	PN Suffix	Connector Configuration Input / Output	PN Example
Dual Junction Circulator 4-Port Device Port 1 / Port 2 / Port 3 / Port 4	No Dash	Female / Female / Female / Female	D4C1213
	-1	Male / Female / Female / Female	D4C1213-1
	-2	Female / Male / Female / Female	D4C1213-2
	-3	Male / Male / Male / Male	D4C1213-3
	-4	Female / Female / Male / Female	D4C1213-4
	-5	Female / Female / Female / Male	D4C1213-5



MEASURED DATA

Part Number: D4C1213, P4→P1, P2 & P3 Terminated with 50Ω, +25°C

