

CYUSB3KIT-001 EZ-USB® FX3

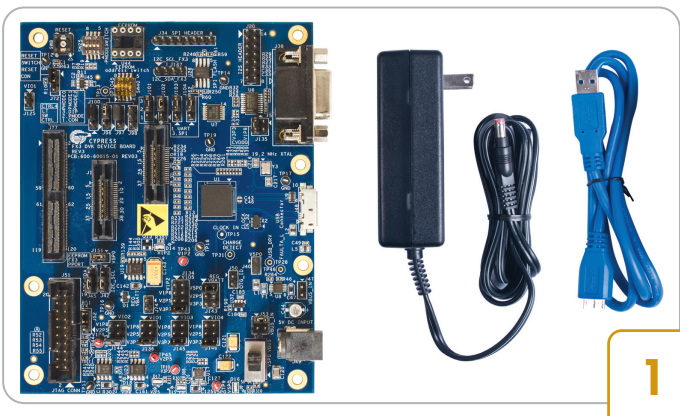

1

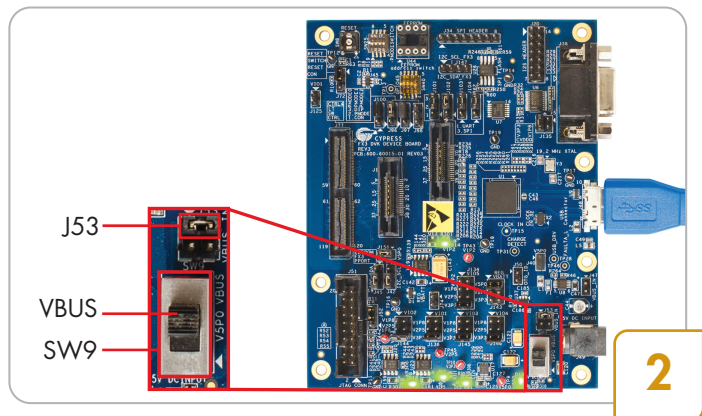

2

Step 1: Software Installation

- Download and install the FX3 DVK (FX3DVKSetup.exe) from <http://www.cypress.com/?rID=58321>
- Download and install the FX3 SDK (FX3SDKSetup.exe) from <http://www.cypress.com/?rID=57990>

Note: For first time users, Cypress recommends accepting the default options at each stage of the setup

Step 2: Powering the FX3 Board

- Ensure that J53 (VBUS_IN) jumper is installed, and the power switch (SW9) is in the VBUS position to select bus-powered mode as shown above
- Connect the micro-B end of the USB cable to the board and connect the other end to the USB 3.0 receptacle on a PC / laptop
- LEDs D14, D15, D16, D17 and D18 glow to indicate that the respective on-board power supplies, 1.2V, 3.3V, 5V, 2.5V and 1.8V are functioning normally

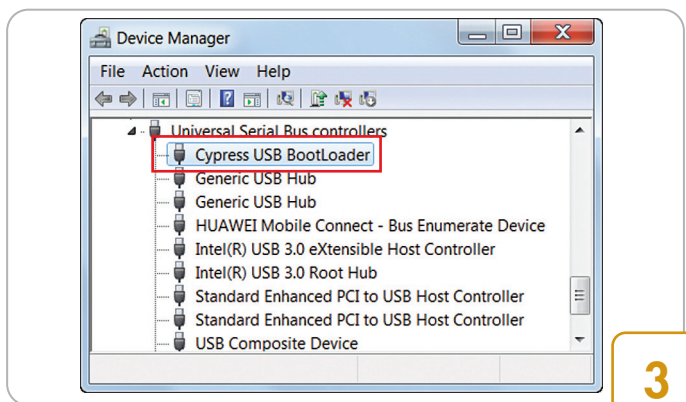

3

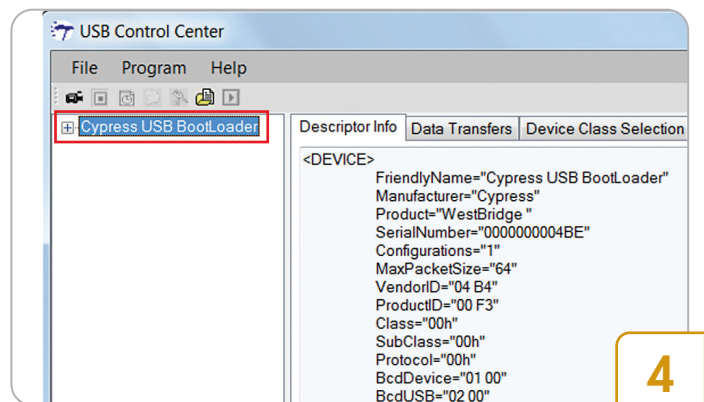

4

Step 3: Installing Driver

- In the Windows Device Manager, the board appears as a **Cypress USB Bootloader** under Universal Bus Controllers. This step confirms the successful enumeration of the FX3 board. If automatic enumeration of FX3 board fails, follow the note below

Note: To manually bind the driver, open **Windows Device Manger**, locate the **Westbridge** device under **other devices**, and right-click on the device to select **Update Driver**. The drivers are located in **C:\Program Files (x86)\Cypress\EZUSB FX3 SDK\1.3*\driver\bin**. Select a driver based on the operating system

Step 4: Starting the Cypress USB Control Center

- Run the Cypress USB Control Center by clicking **Start>All Programs>Cypress>Cypress USBSuite >Control Center**. The board appears as the **Cypress USB Bootloader** in the left panel of the USB Control Center. The USB Control Center helps in loading the FX3 firmware images into the board and to schedule the **Data Transfers** to FX3

* The version number mentioned may vary depending on the latest SDK version

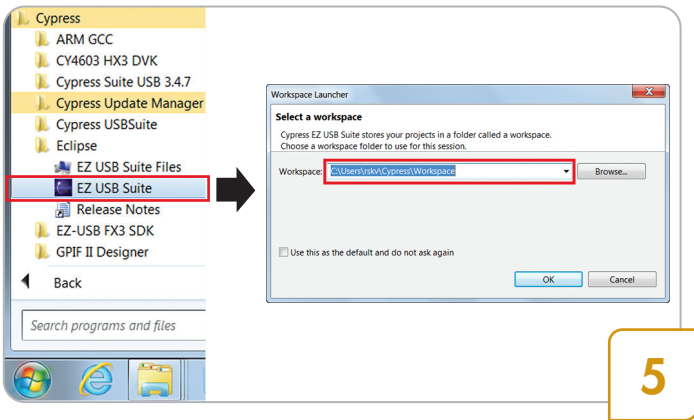

Step 5: Opening the Eclipse IDE

- Open the Eclipse IDE by clicking **Start>All Programs>Cypress>Eclipse>EZ USB Suite**. This launches a first-time startup screen that sets up a Workspace folder for all your Cypress Eclipse work
- Accept the default path of **C:\Users\<(username) \Cypress\Workspace**. An empty Eclipse workbench will be opened

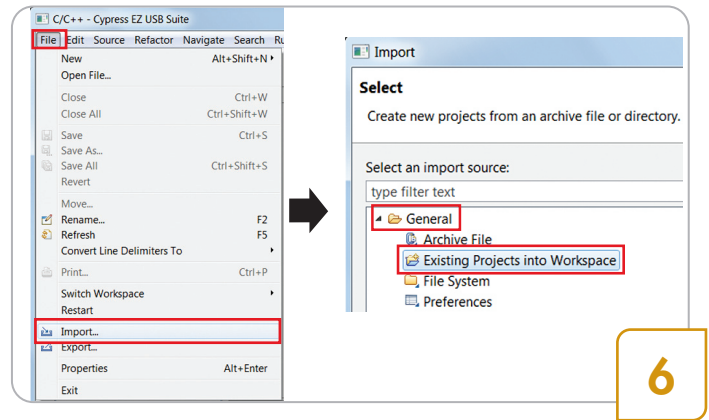

Step 6: Importing FX3 Firmware project

- To import a FX3 firmware project, Select **File>Import**. Import window pops up as a result of this step
- Select **General>Existing Projects into Workspace**
- Click **Next**

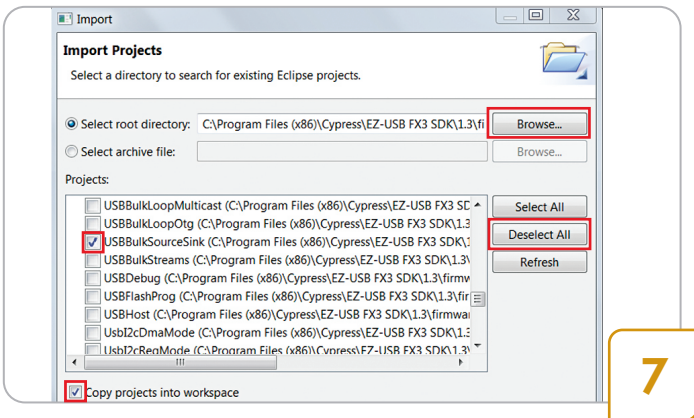

Step 7: Selecting the FX3 Firmware Project

- Select the **Browse...** button next to **Select root directory:**, browse to **C:\Program Files (x86)\Cypress\EZ-USB FX3 SDK\1.3\firmware** folder and click OK. All the firmware projects get listed in the **Projects:** window
- As shown above, **Deselect All** and select only the **USBBulkSourceSink** project in the **Projects:** window
- Check the **Copy projects into workspace** and the project will be copied to your Workspace folder
- Click the **Finish** button

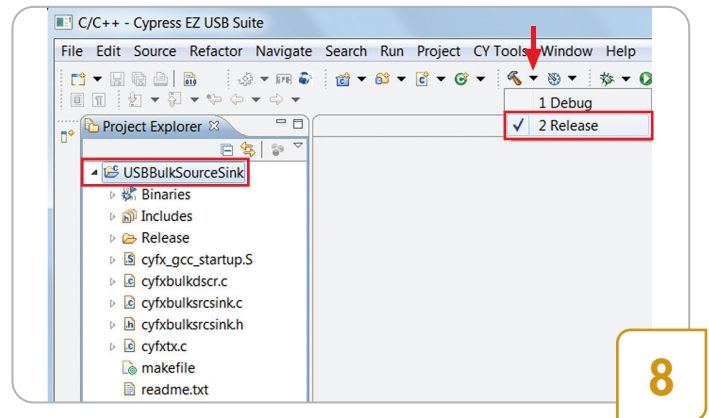

Step 8: Building the FX3 Firmware project

- Select the **USBBulkSourceSink** project in the **Project Explorer** window
- Click the drop-down list next to the debug tool icon and select **Release** to build the release version of the firmware. This generates the Firmware image **USBBulkSourceSink.img**

Note: If you cannot see the debug tool icon at your end, click **Window>Open Perspective>C/C++** to see the missing icons

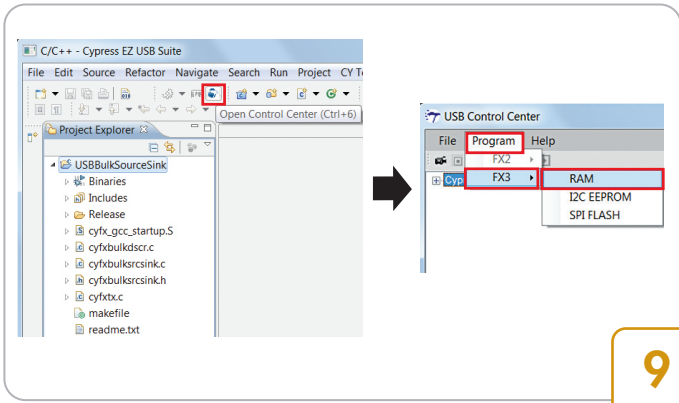

9

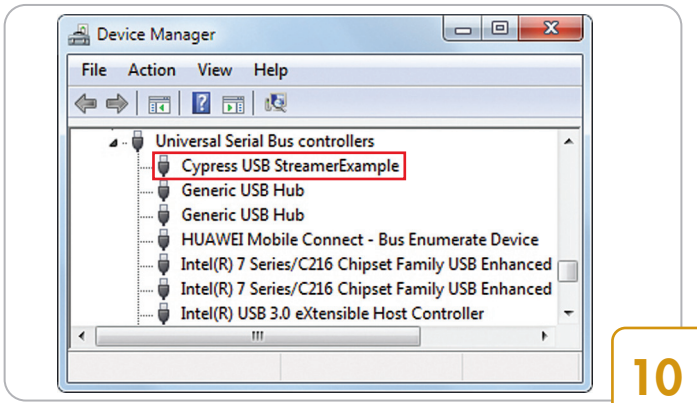

10

Step 9: Downloading the Firmware Image

- Open the USB Control Center application by clicking the **Open Control Center** icon available on the Cypress EZ USB Suite
- Select **Cypress Bootloader** in the left panel of the USB Control Center and click **Program>FX3>RAM**. A pop up window appears asking for the firmware image file. Select **USBBulkSourceSink.img** file located at **C:\Users\{username}\Cypress\Workspace\USBBulkSourceSink\Release** and click **Open**. Once the firmware download is successful, the left bottom corner of the Control Center application displays the status as **Programming Succeeded**

Step 10: Opening Streamer Application

- In the Windows Device Manager the board appears as **Cypress USB StreamerExample** under Universal Bus Controllers. If the board is not listed, bind the driver manually as per the Note given in Step 3
- Run Streamer.exe from the location **C:\Program Files (x86)\Cypress\EZ-USB FX3 SDK\1.3\application\cpp\streamer\x86\Release**

Note: For the best data transfer results always use the C++ streamer application described above

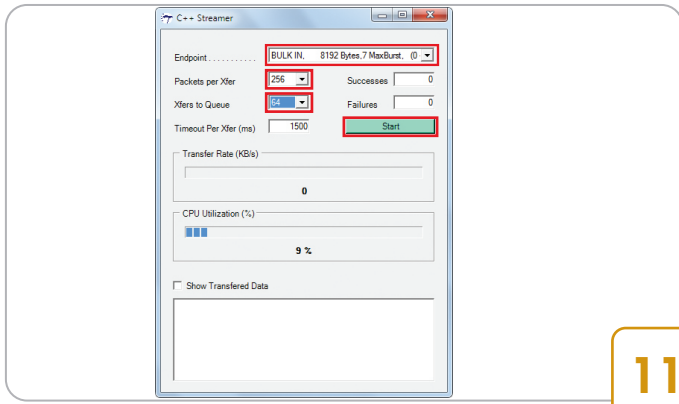

11

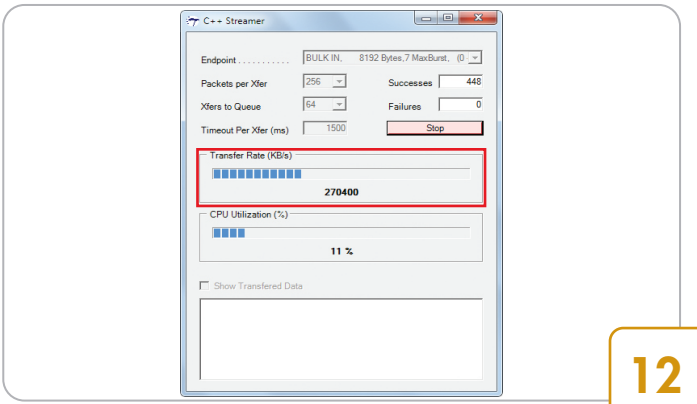

12

Step 11: Configuring Streamer Application

- In the Streamer application, select the following parameters from the drop down list
 - **Endpoint.....** - Bulk in endpoint (0x81)
 - **Packets per Xfer** - 256
 - **Xfers to Queue** - 64
 Configuring the **Packets per Xfer** and **Xfers to Queue** is required to achieve optimum throughput
- Click **start** button

Step 12: Demonstrating USB 3.0 Throughput

- Streamer application displays the USB 3.0 throughput in KB/s as shown above

Note: To achieve higher throughput, refer **Example 3** in **CYUSB3KIT-001 Kit Guide.pdf** located at **C:\Program Files (x86)\Cypress\EZ-USB FX3 Development Kit\1.0**\Documentation**

** The version number mentioned may vary depending on the latest DVK version

CYUSB3KIT-001 EZ-USB® FX3

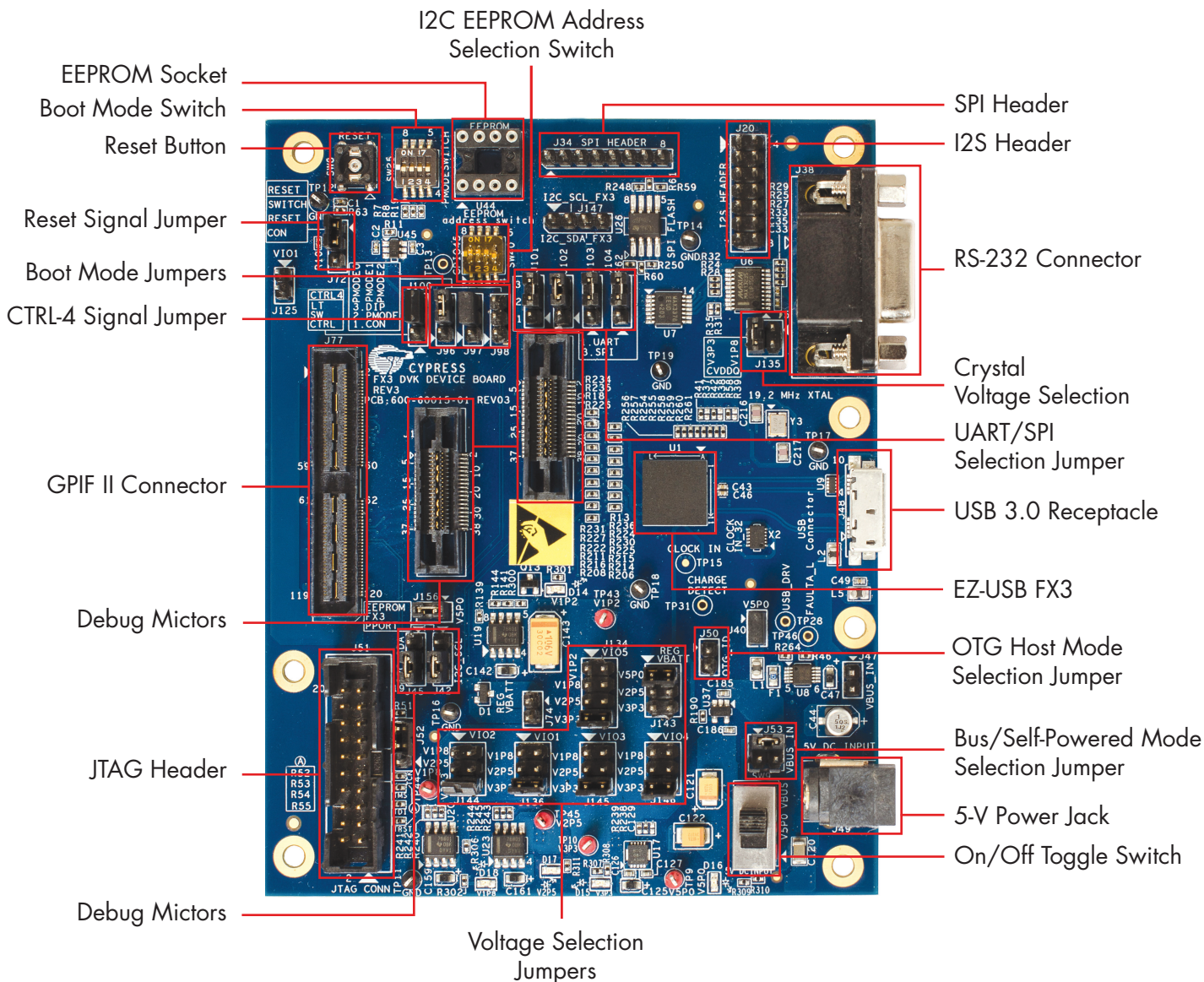

CYUSB3KIT-001 is the development kit (DK) for Cypress's EZ-USB FX3. EZ-USB FX3 is the industry's only programmable USB 3.0 peripheral controller. EZ-USB FX3 provides SuperSpeed connectivity to virtually any system. It is equipped with a highly configurable General Programmable Interface (GPIF™ II), which can be programmed in 8-, 16- and 32-bit configurations with data rates as high as 400 megabytes per second. GPIF II enables FX3 to interface directly to nearly any processor, ASIC or FPGA. The on-chip ARM9 CPU core with 512 KB RAM delivers 200 MIPS of computational power and is available for applications that require local data processing. Additionally, FX3 provides interfaces to connect to serial peripherals such as SPI, UART, I2C and I2S. In short, FX3 provides highly flexible and integrated features that enable developers to add USB 3.0 connectivity to any system. EZ-USB FX3 is in volume production now and is available in two packages: a 121-ball BGA (10 mm x 10 mm) and a space saving 131-ball Wafer-Level Chip Scale Package (WL CSP) with dimensions of 4.1 mm x 5.1 mm.

For the latest information about this kit, visit www.cypress.com/go/CYUSB3KIT-001