

# Data sheet | Item number: 765-1502/100-000

16-channel digital input/output; EtherNet/IP; DC 24 V / 2.0 A; 8xM12 connection; WideLine



[www.wago.com/765-1502/100-000](http://www.wago.com/765-1502/100-000)



*i* Picture differs from the item.

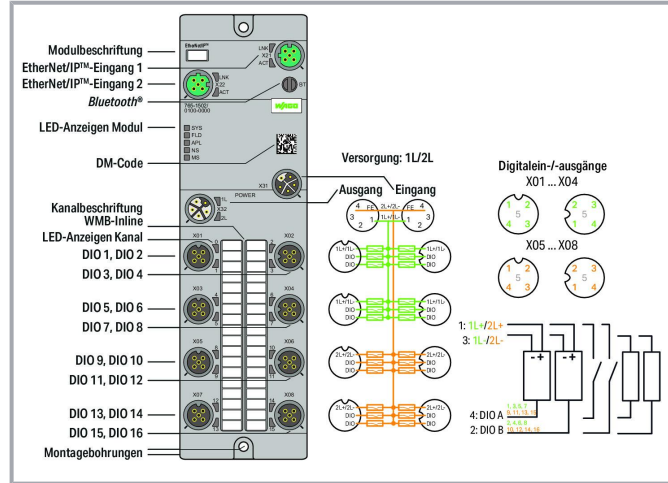

## Data

### Technical data

### Fieldbus

Communication

EtherNet/IP™  
BOOTP, DHCP, DLR

Connection technology: communication/fieldbus

2 x D-coded M12; 4-pole

Interface standard

10BASE-T/100BASE-TX; potential-free

Autonegotiation; autocrossover

yes

### Device functions

Parameter

Input filter  
Output current

Subject to changes. Please also observe the further product documentation!

WAGO GmbH & Co. KG

Hansastr. 27

32423 Minden

Phone: +49571 887-0 | Fax: +49571 887-169

Email: [info.de@wago.com](mailto:info.de@wago.com) | Web: [www.wago.com](http://www.wago.com)

Do you have any questions about our products?

We are always happy to take your call at +49 (571) 887-44222.



	Temperature
Diagnostics	Undervoltage; Overcurrent; Overload; Overtemperature
Device functions	Bluetooth® Bluetooth® OPC UA Server
Visualization	Web server Android/iOS app Webserver

### Digital inputs/outputs

Number of digital inputs	16
Number of digital outputs	16
Connection technology: inputs/outputs	8 x A-coded M12; 5-pole
Signal type (voltage)	24 VDC
Input characteristic	High-side switching
Input filter	0.2 ... 20 ms
Input characteristic	Type 3, per IEC 61131-2
Output current (per channel)	2 A (typ.) for DO
Supply current per port	1L/2L: 4 A (max.)

### Supply (module)

Connection technology: supply	2 x L-coded M12; 5-pole
Supply voltage	24 VDC (18 ... 31.2 V); 1L/2L
Current consumption (max.)	16000 mA
Current consumption (note)	per supply line; overload- and short-circuit-protected
Reverse voltage protection	Yes

### Physical data

Width	60 mm / 2.362 inches
Height	30 mm / 1.181 inches
Depth	210 mm / 8.268 inches

### Mechanical Data

Weight	610 g
Conformity marking	CE

Subject to changes. Please also observe the further product documentation!

## Environmental requirements

Ambient temperature (operation)	-25 ... +70 °C
Ambient temperature (storage)	-40 ... +80 °C
Protection type	IP67
Protection class	III per EN 61140, IEC 61140, VDE 0140-1
Operating altitude	0 ... 2000 m / 0 ... 6562 ft
Pollution degree	3 (EN 60664-1)
Overvoltage category	II (EN 60664-1)
Relative humidity (without condensation)	95 %
Vibration resistance	5g per IEC 60068-2-6
Shock resistance	Short-term: 50g/11 ms/half-sine per IEC 60068-2-27; Long-term: 30g/6 ms/half-sine per IEC 60068-2-29
EMC immunity to interference	per EN 61000-6-2
EMC emission of interference	per EN 61000-6-4

## Commercial data



ETIM 8.0	EC001599
ETIM 7.0	EC001599
PU (SPU)	1 pcs
Packaging type	BOX
Country of origin	DE
GTIN	4066966063080
Customs tariff number	85371098990

## Environmental Product Compliance

RoHS Compliance Status	Compliant, No Exemption
------------------------	-------------------------

## Required accessories

### Cover

Cover		
	<b>Item no.: 756-8102</b> M12 protective cap; for unused sockets	<a href="http://www.wago.com/756-8102">www.wago.com/756-8102</a>
	<b>Item no.: 756-8103</b> M12 protective cap; for unused plugs	<a href="http://www.wago.com/756-8103">www.wago.com/756-8103</a>



### Tool

Assembly tool	
---------------	--

Subject to changes. Please also observe the further product documentation!









	<b>Item no.: 206-701</b> Torque wrench M8 and M12; Assembly kit	<a href="http://www.wago.com/206-701">www.wago.com/206-701</a>
---	--	--

**Marking accessories**













Marking strip		
	<b>Item no.: 2009-110</b> Marking strips; for Smart Printer; on reel; not stretchable; plain; snap-on type; white	<a href="http://www.wago.com/2009-110">www.wago.com/2009-110</a>
Marker		
	<b>Item no.: 2009-115</b> WMB-Inline; for Smart Printer; 1500 pieces on roll; stretchable 5 - 5.2 mm; plain; snap-on type; white	<a href="http://www.wago.com/2009-115">www.wago.com/2009-115</a>

**Optional accessories**

**Cables and pluggable connectors**

Sensor/actuator cable		
	<b>Item no.: 756-5402/040-010</b> Sensor/Actuator cable; M12A socket; straight; M12A plug; angled; 4-pole; Length: 1 m	<a href="http://www.wago.com/756-5402/040-010">www.wago.com/756-5402/040-010</a>
	<b>Item no.: 756-5402/040-020</b> Sensor/Actuator cable; M12A socket; straight; M12A plug; angled; 4-pole; Length: 2 m	<a href="http://www.wago.com/756-5402/040-020">www.wago.com/756-5402/040-020</a>
	<b>Item no.: 756-5311/040-050</b> Sensor/Actuator cable; M12A plug; straight; 4-pole; Length: 5 m	<a href="http://www.wago.com/756-5311/040-050">www.wago.com/756-5311/040-050</a>
	<b>Item no.: 756-5311/040-015</b> Sensor/Actuator cable; M12A plug; straight; 4-pole; Length: 1.5 m	<a href="http://www.wago.com/756-5311/040-015">www.wago.com/756-5311/040-015</a>
	<b>Item no.: 756-5311/040-100</b> Sensor/Actuator cable; M12A plug; straight; 4-pole; Length: 10 m	<a href="http://www.wago.com/756-5311/040-100">www.wago.com/756-5311/040-100</a>
	<b>Item no.: 756-5404/040-020</b> Sensor/Actuator cable; M12A socket; angled; M12A plug; angled; 4-pole; Length: 2 m	<a href="http://www.wago.com/756-5404/040-020">www.wago.com/756-5404/040-020</a>
	<b>Item no.: 756-5510/040-010</b> Sensor/Actuator cable; M8 socket; angled; M12A plug; angled; 4-pole; Length: 1 m	<a href="http://www.wago.com/756-5510/040-010">www.wago.com/756-5510/040-010</a>
	<b>Item no.: 756-5510/040-020</b> Sensor/Actuator cable; M8 socket; angled; M12A plug; angled; 4-pole; Length: 2 m	<a href="http://www.wago.com/756-5510/040-020">www.wago.com/756-5510/040-020</a>

Subject to changes. Please also observe the further product documentation!

	<b>Item no.: 756-5401/040-020</b> Sensor/Actuator cable; M12A socket; straight; M12A plug; straight; 4-pole; Length: 2 m	<a href="http://www.wago.com/756-5401/040-020">www.wago.com/756-5401/040-020</a>
	<b>Item no.: 756-5401/040-010</b> Sensor/Actuator cable; M12A socket; straight; M12A plug; straight; 4-pole; Length: 1 m	<a href="http://www.wago.com/756-5401/040-010">www.wago.com/756-5401/040-010</a>
	<b>Item no.: 756-5507/040-010</b> Sensor/Actuator cable; M8 socket; straight; M12A plug; straight; 4-pole; Length: 1 m	<a href="http://www.wago.com/756-5507/040-010">www.wago.com/756-5507/040-010</a>
	<b>Item no.: 756-5507/040-020</b> Sensor/Actuator cable; M8 socket; straight; M12A plug; straight; 4-pole; Length: 2 m	<a href="http://www.wago.com/756-5507/040-020">www.wago.com/756-5507/040-020</a>
	<b>Item no.: 756-5404/040-010</b> Sensor/Actuator cable; M12A socket; angled; M12A plug; angled; 4-pole; Length: 1 m	<a href="http://www.wago.com/756-5404/040-010">www.wago.com/756-5404/040-010</a>
	<b>Item no.: 756-5312/040-015</b> Sensor/Actuator cable; M12A plug; angled; 4-pole; Length: 1.5 m	<a href="http://www.wago.com/756-5312/040-015">www.wago.com/756-5312/040-015</a>
	<b>Item no.: 756-5312/040-050</b> Sensor/Actuator cable; M12A plug; angled; 4-pole; Length: 5 m	<a href="http://www.wago.com/756-5312/040-050">www.wago.com/756-5312/040-050</a>
	<b>Item no.: 756-5509/040-010</b> Sensor/Actuator cable; M8 socket; angled; M12A plug; straight; 4-pole; Length: 1 m	<a href="http://www.wago.com/756-5509/040-010">www.wago.com/756-5509/040-010</a>
	<b>Item no.: 756-5509/040-020</b> Sensor/Actuator cable; M8 socket; angled; M12A plug; straight; 4-pole; Length: 2 m	<a href="http://www.wago.com/756-5509/040-020">www.wago.com/756-5509/040-020</a>
	<b>Item no.: 756-5403/040-010</b> Sensor/Actuator cable; M12A socket; angled; M12A plug; straight; 4-pole; Length: 1 m	<a href="http://www.wago.com/756-5403/040-010">www.wago.com/756-5403/040-010</a>
	<b>Item no.: 756-5312/040-100</b> Sensor/Actuator cable; M12A plug; angled; 4-pole; Length: 10 m	<a href="http://www.wago.com/756-5312/040-100">www.wago.com/756-5312/040-100</a>
	<b>Item no.: 756-5403/040-020</b> Sensor/Actuator cable; M12A socket; angled; M12A plug; straight; 4-pole; Length: 2 m	<a href="http://www.wago.com/756-5403/040-020">www.wago.com/756-5403/040-020</a>
	<b>Item no.: 756-5508/040-010</b> Sensor/Actuator cable; M8 socket; straight; M12A plug; angled; 4-pole; Length: 1 m	<a href="http://www.wago.com/756-5508/040-010">www.wago.com/756-5508/040-010</a>

Subject to changes. Please also observe the further product documentation!



**Item no.: 756-5508/040-020**  
Sensor/Actuator cable; M8 socket; straight; M12A plug; angled; 4-pole; Length: 2 m

[www.wago.com/756-5508/040-020](http://www.wago.com/756-5508/040-020)

---

Configurable connectors



**Item no.: 756-9202/040-000**  
Fitted pluggable connector; 4-pole; M12 plug, straight, A-coded; Spring

[www.wago.com/756-9202/040-000](http://www.wago.com/756-9202/040-000)



**Item no.: 756-9205/040-000**  
Fitted pluggable connector; 4-pole; M12 plug, right angle; Spring

[www.wago.com/756-9205/040-000](http://www.wago.com/756-9205/040-000)



**Item no.: 756-9711/050-000**  
Fitted pluggable connector; 5-pole, shielded; M12 socket, straight; IDC technology

[www.wago.com/756-9711/050-000](http://www.wago.com/756-9711/050-000)



**Item no.: 756-9701/050-000**  
Fitted pluggable connector; 5-pole, shielded; M12 plug, straight; IDC technology

[www.wago.com/756-9701/050-000](http://www.wago.com/756-9701/050-000)

---

Configurable shielded connectors



**Item no.: 756-9501/060-000**  
Fitted pluggable connector; 4-pole, shielded; M12 plug, straight, D-coded; Spring

[www.wago.com/756-9501/060-000](http://www.wago.com/756-9501/060-000)



**Item no.: 756-9501/040-000**  
Accessories; M12 plug, right angle; 4-pole

[www.wago.com/756-9501/040-000](http://www.wago.com/756-9501/040-000)

---

Power cable



**Item no.: 756-3501/050-075**  
Power cable; M12L socket; straight; 5-pole; Length: 7.5 m

[www.wago.com/756-3501/050-075](http://www.wago.com/756-3501/050-075)



**Item no.: 756-3501/050-100**  
Power cable; M12L socket; straight; 5-pole; Length: 10 m

[www.wago.com/756-3501/050-100](http://www.wago.com/756-3501/050-100)



**Item no.: 756-3501/050-150**  
Power cable; M12L socket; straight; 5-pole; Length: 15 m

[www.wago.com/756-3501/050-150](http://www.wago.com/756-3501/050-150)













**Item no.: 756-3501/050-050**  
Power cable; M12L socket; straight; 5-pole; Length: 5 m







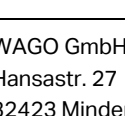





[www.wago.com/756-3501/050-050](http://www.wago.com/756-3501/050-050)

---

Subject to changes. Please also observe the further product documentation!













	<b>Item no.: 756-3502/050-050</b> Power cable; M12L socket; angled; 5-pole; Length: 5 m	<a href="http://www.wago.com/756-3502/050-050">www.wago.com/756-3502/050-050</a>
	<b>Item no.: 756-3502/050-150</b> Power cable; M12L socket; angled; 5-pole; Length: 15 m	<a href="http://www.wago.com/756-3502/050-150">www.wago.com/756-3502/050-150</a>
	<b>Item no.: 756-3502/050-075</b> Power cable; M12L socket; angled; 5-pole; Length: 7.5 m	<a href="http://www.wago.com/756-3502/050-075">www.wago.com/756-3502/050-075</a>
	<b>Item no.: 756-3502/050-100</b> Power cable; M12L socket; angled; 5-pole; Length: 10 m	<a href="http://www.wago.com/756-3502/050-100">www.wago.com/756-3502/050-100</a>
	<b>Item no.: 756-3503/050-075</b> Power cable; M12L plug; straight; 5-pole; Length: 7.5 m	<a href="http://www.wago.com/756-3503/050-075">www.wago.com/756-3503/050-075</a>
	<b>Item no.: 756-3503/050-150</b> Power cable; M12L plug; straight; 5-pole; Length: 15 m	<a href="http://www.wago.com/756-3503/050-150">www.wago.com/756-3503/050-150</a>
	<b>Item no.: 756-3503/050-100</b> Power cable; M12L plug; straight; 5-pole; Length: 10 m	<a href="http://www.wago.com/756-3503/050-100">www.wago.com/756-3503/050-100</a>
	<b>Item no.: 756-3505/050-003</b> Power cable; M12L socket; straight; M12L plug; straight; 5-pole; Length: 0.3 m	<a href="http://www.wago.com/756-3505/050-003">www.wago.com/756-3505/050-003</a>
	<b>Item no.: 756-3505/050-005</b> Power cable; M12L socket; straight; M12L plug; straight; 5-pole; Length: 0.5 m	<a href="http://www.wago.com/756-3505/050-005">www.wago.com/756-3505/050-005</a>
	<b>Item no.: 756-3505/050-020</b> Power cable; M12L socket; straight; M12L plug; straight; 5-pole; Length: 2 m	<a href="http://www.wago.com/756-3505/050-020">www.wago.com/756-3505/050-020</a>
	<b>Item no.: 756-3505/050-010</b> Power cable; M12L socket; straight; M12L plug; straight; 5-pole; Length: 1 m	<a href="http://www.wago.com/756-3505/050-010">www.wago.com/756-3505/050-010</a>
	<b>Item no.: 756-3505/050-050</b> Power cable; M12L socket; straight; M12L plug; straight; 5-pole; Length: 5 m	<a href="http://www.wago.com/756-3505/050-050">www.wago.com/756-3505/050-050</a>

Subject to changes. Please also observe the further product documentation!

	<b>Item no.: 756-3505/050-075</b> Power cable; M12L socket; straight; M12L plug; straight; 5-pole; Length: 7.5 m	<a href="http://www.wago.com/756-3505/050-075">www.wago.com/756-3505/050-075</a>
	<b>Item no.: 756-3505/050-100</b> Power cable; M12L socket; straight; M12L plug; straight; 5-pole; Length: 10 m	<a href="http://www.wago.com/756-3505/050-100">www.wago.com/756-3505/050-100</a>
	<b>Item no.: 756-3506/050-100</b> Power cable; M12L socket; angled; M12L plug; angled; 5-pole; Length: 10 m	<a href="http://www.wago.com/756-3506/050-100">www.wago.com/756-3506/050-100</a>
	<b>Item no.: 756-3506/050-075</b> Power cable; M12L socket; angled; M12L plug; angled; 5-pole; Length: 7.5 m	<a href="http://www.wago.com/756-3506/050-075">www.wago.com/756-3506/050-075</a>
	<b>Item no.: 756-3506/050-150</b> Power cable; M12L socket; angled; M12L plug; angled; 5-pole; Length: 15 m	<a href="http://www.wago.com/756-3506/050-150">www.wago.com/756-3506/050-150</a>
	<b>Item no.: 756-3501/050-020</b> Power cable; M12L socket; straight; 5-pole; Length: 2 m	<a href="http://www.wago.com/756-3501/050-020">www.wago.com/756-3501/050-020</a>
	<b>Item no.: 756-3502/050-020</b> Power cable; M12L socket; angled; 5-pole; Length: 2 m	<a href="http://www.wago.com/756-3502/050-020">www.wago.com/756-3502/050-020</a>
	<b>Item no.: 756-3503/050-020</b> Power cable; M12L plug; straight; 5-pole; Length: 2 m	<a href="http://www.wago.com/756-3503/050-020">www.wago.com/756-3503/050-020</a>
	<b>Item no.: 756-3503/050-050</b> Power cable; M12L plug; straight; 5-pole; Length: 5 m	<a href="http://www.wago.com/756-3503/050-050">www.wago.com/756-3503/050-050</a>
	<b>Item no.: 756-3504/050-020</b> Power cable; M12L plug; angled; 5-pole; Length: 2 m	<a href="http://www.wago.com/756-3504/050-020">www.wago.com/756-3504/050-020</a>
	<b>Item no.: 756-3504/050-050</b> Power cable; M12L plug; angled; 5-pole; Length: 5 m	<a href="http://www.wago.com/756-3504/050-050">www.wago.com/756-3504/050-050</a>
	<b>Item no.: 756-3504/050-075</b> Power cable; M12L plug; angled; 5-pole; Length: 7.5 m	<a href="http://www.wago.com/756-3504/050-075">www.wago.com/756-3504/050-075</a>

Subject to changes. Please also observe the further product documentation!



	<b>Item no.: 756-3504/050-100</b> Power cable; M12L plug; angled; 5-pole; Length: 10 m	<a href="http://www.wago.com/756-3504/050-100">www.wago.com/756-3504/050-100</a>
	<b>Item no.: 756-3504/050-150</b> Power cable; M12L plug; angled; 5-pole; Length: 15 m	<a href="http://www.wago.com/756-3504/050-150">www.wago.com/756-3504/050-150</a>
	<b>Item no.: 756-3505/050-150</b> Power cable; M12L socket; straight; M12L plug; straight; 5-pole; Length: 15 m	<a href="http://www.wago.com/756-3505/050-150">www.wago.com/756-3505/050-150</a>
	<b>Item no.: 756-3506/050-003</b> Power cable; M12L socket; angled; M12L plug; angled; 5-pole; Length: 0.3 m	<a href="http://www.wago.com/756-3506/050-003">www.wago.com/756-3506/050-003</a>
	<b>Item no.: 756-3506/050-005</b> Power cable; M12L socket; angled; M12L plug; angled; 5-pole; Length: 0.5 m	<a href="http://www.wago.com/756-3506/050-005">www.wago.com/756-3506/050-005</a>
	<b>Item no.: 756-3506/050-020</b> Power cable; M12L socket; angled; M12L plug; angled; 5-pole; Length: 2 m	<a href="http://www.wago.com/756-3506/050-020">www.wago.com/756-3506/050-020</a>
	<b>Item no.: 756-3506/050-010</b> Power cable; M12L socket; angled; M12L plug; angled; 5-pole; Length: 1 m	<a href="http://www.wago.com/756-3506/050-010">www.wago.com/756-3506/050-010</a>
	<b>Item no.: 756-3506/050-050</b> Power cable; M12L socket; angled; M12L plug; angled; 5-pole; Length: 5 m	<a href="http://www.wago.com/756-3506/050-050">www.wago.com/756-3506/050-050</a>
Distribution connector		
	<b>Item no.: 756-5513/040-010</b> Sensor/Actuator cable; 2xM8 socket; straight; M12A plug; straight; 4-pole; Length: 1 m	<a href="http://www.wago.com/756-5513/040-010">www.wago.com/756-5513/040-010</a>
	<b>Item no.: 756-5513/040-020</b> Sensor/Actuator cable; 2xM8 socket; straight; M12A plug; straight; 4-pole; Length: 2 m	<a href="http://www.wago.com/756-5513/040-020">www.wago.com/756-5513/040-020</a>
	<b>Item no.: 756-5514/040-010</b> Sensor/Actuator cable; 2xM8 socket; angled; M12A plug; straight; 4-pole; Length: 1 m	<a href="http://www.wago.com/756-5514/040-010">www.wago.com/756-5514/040-010</a>
	<b>Item no.: 756-5514/040-020</b> Sensor/Actuator cable; 2xM8 socket; angled; M12A plug; straight; 4-pole; Length: 2 m	<a href="http://www.wago.com/756-5514/040-020">www.wago.com/756-5514/040-020</a>
	<b>Item no.: 756-5516/040-010</b> Sensor/Actuator cable; 2xM12 socket; straight; M12A plug; straight; 4-pole; Length: 1 m	<a href="http://www.wago.com/756-5516/040-010">www.wago.com/756-5516/040-010</a>

Subject to changes. Please also observe the further product documentation!



Item no.: 756-5516/040-020  
Sensor/Actuator cable; 2xM12 socket; straight; M12A plug; straight; 4-pole; Length: 2 m

[www.wago.com/756-5516/040-020](http://www.wago.com/756-5516/040-020)



Item no.: 756-5517/040-010  
Sensor/Actuator cable; 2xM12 socket; angled; M12A plug; straight; 4-pole; Length: 1 m

[www.wago.com/756-5517/040-010](http://www.wago.com/756-5517/040-010)



Item no.: 756-5517/040-020  
Sensor/Actuator cable; 2xM12 socket; angled; M12A plug; straight; 4-pole; Length: 2 m

[www.wago.com/756-5517/040-020](http://www.wago.com/756-5517/040-020)



Item no.: 756-9301/050-000  
Accessories; 5-pole

[www.wago.com/756-9301/050-000](http://www.wago.com/756-9301/050-000)



Item no.: 756-9301/040-000  
Accessories; 4-pole

[www.wago.com/756-9301/040-000](http://www.wago.com/756-9301/040-000)

#### Adapter



Item no.: 756-9503/040-000  
Accessories; 4-pole

[www.wago.com/756-9503/040-000](http://www.wago.com/756-9503/040-000)



Item no.: 756-9504/040-000  
Accessories; 4-pole

[www.wago.com/756-9504/040-000](http://www.wago.com/756-9504/040-000)

#### ETHERNET/PROFINET cable



Item no.: 756-1202/060-200  
ETHERNET cable; M12D plug; angled; 4-pole; Length: 20 m

[www.wago.com/756-1202/060-200](http://www.wago.com/756-1202/060-200)



Item no.: 756-1201/060-100  
ETHERNET cable; M12D plug; straight; 4-pole; Length: 10 m

[www.wago.com/756-1201/060-100](http://www.wago.com/756-1201/060-100)



Item no.: 756-1201/060-050  
ETHERNET cable; M12D plug; straight; 4-pole; Length: 5 m













[www.wago.com/756-1201/060-050](http://www.wago.com/756-1201/060-050)



Item no.: 756-1203/060-050  
ETHERNET cable; M12D plug; straight; M12D plug; straight; 4-pole; Length: 5 m

[www.wago.com/756-1203/060-050](http://www.wago.com/756-1203/060-050)

Subject to changes. Please also observe the further product documentation!

	<b>Item no.: 756-1203/060-020</b> ETHERNET cable; M12D plug; straight; M12D plug; straight; 4-pole; Length: 2 m	<a href="http://www.wago.com/756-1203/060-020">www.wago.com/756-1203/060-020</a>
	<b>Item no.: 756-1202/060-020</b> ETHERNET cable; M12D plug; angled; 4-pole; Length: 2 m	<a href="http://www.wago.com/756-1202/060-020">www.wago.com/756-1202/060-020</a>
	<b>Item no.: 756-1201/060-200</b> ETHERNET cable; M12D plug; straight; 4-pole; Length: 20 m	<a href="http://www.wago.com/756-1201/060-200">www.wago.com/756-1201/060-200</a>
	<b>Item no.: 756-1204/060-050</b> ETHERNET cable; M12D plug; angled; M12D plug; angled; 4-pole; Length: 5 m	<a href="http://www.wago.com/756-1204/060-050">www.wago.com/756-1204/060-050</a>
	<b>Item no.: 756-1204/060-100</b> ETHERNET cable; M12D plug; angled; M12D plug; angled; 4-pole; Length: 10 m	<a href="http://www.wago.com/756-1204/060-100">www.wago.com/756-1204/060-100</a>
	<b>Item no.: 756-1204/060-200</b> ETHERNET cable; M12D plug; angled; M12D plug; angled; 4-pole; Length: 20 m	<a href="http://www.wago.com/756-1204/060-200">www.wago.com/756-1204/060-200</a>
	<b>Item no.: 756-1203/060-200</b> ETHERNET cable; M12D plug; straight; M12D plug; straight; 4-pole; Length: 20 m	<a href="http://www.wago.com/756-1203/060-200">www.wago.com/756-1203/060-200</a>
	<b>Item no.: 756-1203/060-100</b> ETHERNET cable; M12D plug; straight; M12D plug; straight; 4-pole; Length: 10 m	<a href="http://www.wago.com/756-1203/060-100">www.wago.com/756-1203/060-100</a>
	<b>Item no.: 756-1204/060-010</b> ETHERNET cable; M12D plug; angled; M12D plug; angled; 4-pole; Length: 1 m	<a href="http://www.wago.com/756-1204/060-010">www.wago.com/756-1204/060-010</a>
	<b>Item no.: 756-1204/060-030</b> ETHERNET cable; M12D plug; angled; M12D plug; angled; 4-pole; Length: 3 m	<a href="http://www.wago.com/756-1204/060-030">www.wago.com/756-1204/060-030</a>
	<b>Item no.: 756-1204/060-020</b> ETHERNET cable; M12D plug; angled; M12D plug; angled; 4-pole; Length: 2 m	<a href="http://www.wago.com/756-1204/060-020">www.wago.com/756-1204/060-020</a>
	<b>Item no.: 756-1202/060-050</b> ETHERNET cable; M12D plug; angled; 4-pole; Length: 5 m	<a href="http://www.wago.com/756-1202/060-050">www.wago.com/756-1202/060-050</a>

Subject to changes. Please also observe the further product documentation!



Item no.: 756-1202/060-100  
ETHERNET cable; M12D plug; angled; 4-pole; Length: 10 m

[www.wago.com/756-1202/060-100](http://www.wago.com/756-1202/060-100)



Item no.: 756-1201/060-020  
ETHERNET cable; M12D plug; straight; 4-pole; Length: 2 m

[www.wago.com/756-1201/060-020](http://www.wago.com/756-1201/060-020)

## Downloads

### Documentation

#### Manual

Product Manual 16-Channel Digital Input/Output; EtherNet/IP DC 24 V / 2.0 A; 8xM12 Connection; WideLine	V 2.0.0 2022 Jul 19	pdf 8.0 MB	Download
--	------------------------	---------------	----------

#### System Description

WAGO I/O System Field; General Product Information		pdf 1.0 MB	Download
--	--	---------------	----------

### Runtime Software

#### Firmware

0765-x5xx, Ethernet/IP IO-Field WAGO_FW0765-x5xx_V01010021_IX04	V 04 2023 Feb 2	zip 1.6 MB	Download
--	--------------------	---------------	----------

### CAD/CAE-Data

#### CAD data

2D/3D Models 765-1502/100-000		URL	Download
-------------------------------	--	-----	----------

#### CAE data

EPLAN Data Portal 765-1502/100-000		URL	Download
------------------------------------	--	-----	----------

### Device Files

#### Device Description File

Subject to changes. Please also observe the further product documentation!



750-915; EDS-Dateien for EthernetIP / Serie 750, 765 and 767	12 2021 Jul 9	zip 168.4 kB	Download
Gerätebeschreibungsdateien 765-45xx, 765-15xx, EtherNet/IP	V1_1_0_11	zip 75.8 kB	Download

## Environmental Product Compliance

### Compliance Search

Environmental Product Compliance 765-1502/100-000	URL	Download
16-channel digital input/output; EtherNet/IP; DC 24 V / 2.0 A; 8xM12 connection; WideLine		

## Installation Notes

## Product family

**WAGO I/O System Field**  
[Show all products from the family](#)

Subject to changes. Please also observe the further product documentation!

WAGO GmbH & Co. KG  
Hansastr. 27  
32423 Minden  
Phone: +49571 887-0 | Fax: +49571 887-169  
Email: [info.de@wago.com](mailto:info.de@wago.com) | Web: [www.wago.com](http://www.wago.com)

Do you have any questions about our products?  
We are always happy to take your call at +49 (571) 887-44222.