

## RSBWC1220DQ00J

Aliases (SBWC1220DQ00J)

RSB, Film, Metallized Polyester Stacked, Automotive Grade, 2200 pF, 5%, 500 VDC, 85°C, Lead Spacing = 5mm

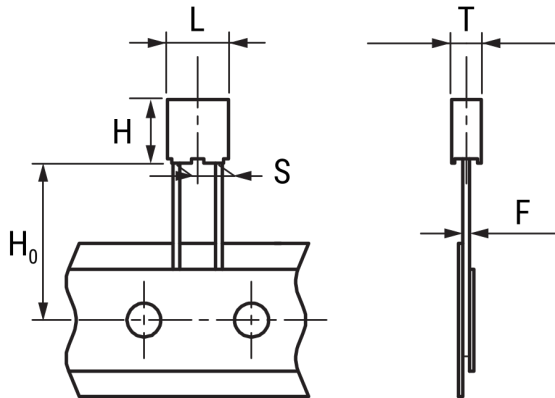

Click [here](#) for the 3D model.

### Dimensions

L	7.2mm +0.2mm
H	7.5mm +0.1mm
T	3.5mm +0.2mm
S	5mm +0.6/-0.1mm
H0	18.5mm +/-0.5mm
F	0.5mm +/-0.05mm

### Packaging Specifications

Packaging	Ammo, 360x340x59mm, Box
Packaging Quantity	2500

### General Information

Series	RSB
Dielectric	Metallized Polyester Stacked
Style	Radial
Features	Automotive Grade, DC Multipurpose Applications
RoHS	Yes
Lead	Wire Leads
Qualifications	AEC-Q200
AEC-Q200	Yes
Miscellaneous	Above 85C DC And AC Voltage Derating Is 1.25%/C.

### Specifications

Capacitance	2200 pF
Capacitance Tolerance	5%
Voltage AC	220 VAC
Voltage DC	500 VDC
Temperature Range	-55/+125°C
Rated Temperature	85°C
Dissipation Factor	0.8% 1kHz, 1.2% 10kHz, 2.5% 100kHz
Insulation Resistance	30 GOhms
Max dV/dt	700 V/us
Inductance	7 nH