

Data sheet | Item number: 236-205

PCB terminal block; 2.5 mm<sup>2</sup>; Pin spacing 7.5/7.62 mm; 5-pole; CAGE CLAMP®; commoning option; 2,50 mm<sup>2</sup>; gray



[www.wago.com/236-205](http://www.wago.com/236-205)



**i** Picture differs from the item.

Color: —

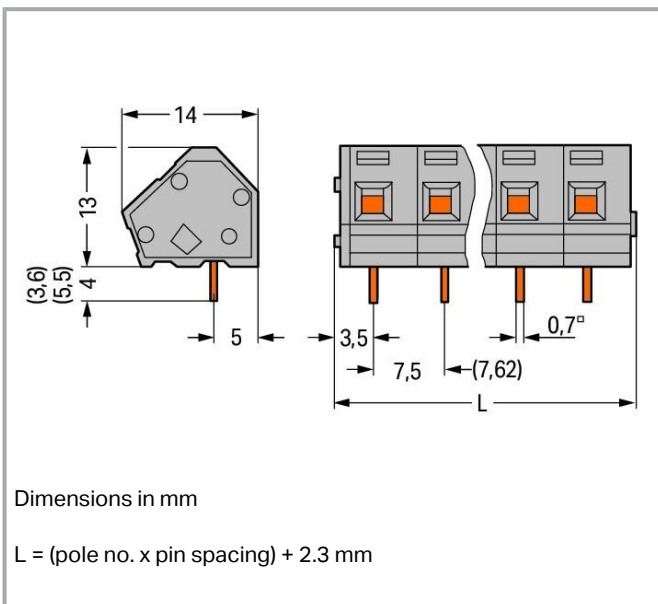

Subject to changes. Please also observe the further product documentation!

WAGO GmbH & Co. KG  
Hansastr. 27  
32423 Minden  
Phone: +49571 887-0 | Fax: +49571 887-169  
Email: [info.de@wago.com](mailto:info.de@wago.com) | Web: [www.wago.com](http://www.wago.com)

Do you have any questions about our products?  
We are always happy to take your call at +49 (571) 887-44222.



## Item description

- PCB terminal strips with CAGE CLAMP<sup>®</sup> connection, screwdriver actuation parallel or perpendicular to conductor entry
- Versions with Ex approval
- Mixed-color PCB terminal strips from factory
- Operating tools for factory wiring
- 45° conductor entry angle permits a wide range of applications and wiring options
- Set to metric or inch pin spacing by compressing PCB terminal strips or pulling them apart

## Data

### Notes

Variants:

Other pole numbers

Versions for Ex e II and Ex i

Other colors

Mixed-color PCB connector strips

Direct marking

Solder pin length: 3.6 mm

Solder pin length: 5.5 mm

Other versions (or variants) can be requested from WAGO Sales or configured at <https://configurator.wago.com/>.

## Electrical data

### Ratings per IEC/EN

| Ratings per                   | IEC/EN 60664-1   |
|-------------------------------|--|
| Nominal voltage (III/3)       | 400 V  |
| Rated impulse voltage (III/3) | 6 kV   |
| Rated voltage (III/2)         | 630 V  |
| Rated impulse voltage (III/2) | 6 kV   |
| Nominal voltage (II/2)        | 1000 V   |
| Rated surge voltage (II/2)    | 6 kV   |
| Rated current                 | 24 A   |
| Legend (ratings)              | (III / 2) $\triangleq$ Overvoltage category III / Pollution degree 2 |

### Ratings per UL 1059

| Approvals per                  | UL 1059 |
|--------------------------------|---------|
| Rated voltage UL (Use Group B) | 300 V   |

Subject to changes. Please also observe the further product documentation!

WAGO GmbH & Co. KG

Hansastr. 27

32423 Minden

Phone: +49571 887-0 | Fax: +49571 887-169

Email: [info.de@wago.com](mailto:info.de@wago.com) | Web: [www.wago.com](http://www.wago.com)

Do you have any questions about our products?

We are always happy to take your call at +49 (571) 887-44222.



|                                |       |
|--------------------------------|-------|
| Rated current UL (Use Group B) | 15 A  |
| Rated voltage UL (Use Group D) | 300 V |
| Rated current UL (Use Group D) | 10 A  |

### Ratings per CSA

|                                 |       |
|---------------------------------|-------|
| Approvals per                   | CSA   |
| Rated voltage CSA (Use Group B) | 300 V |
| Rated current CSA (Use Group B) | 15 A  |
| Rated voltage CSA (Use Group D) | 300 V |
| Rated current CSA (Use Group D) | 10 A  |

### Connection data

|                            |   |
|----------------------------|---|
| Connection points          | 5 |
| Total number of potentials | 5 |
| Number of connection types | 1 |
| Number of levels           | 1 |

### Connection 1

|   |  |
|---|--|
| Connection technology                             | CAGE CLAMP®                                  |
| Actuation type                                    | Operating tool                               |
| Solid conductor                                   | 0.08 ... 2.5 mm <sup>2</sup> / 28 ... 12 AWG |
| Fine-stranded conductor                           | 0.08 ... 2.5 mm <sup>2</sup> / 28 ... 12 AWG |
| Fine-stranded conductor; with insulated ferrule   | 0.25 ... 1.5 mm <sup>2</sup>                 |
| Fine-stranded conductor; with uninsulated ferrule | 0.25 ... 1.5 mm <sup>2</sup>                 |
| Note (conductor cross-section)                    | 12 AWG: THHN, THWN                           |
| Strip length                                      | 5 ... 6 mm / 0.2 ... 0.24 inches             |
| Conductor connection direction to PCB             | 45 °   |
| Pole number                                       | 5  |

### Physical data

|                         |                                |
|-------------------------|--------------------------------|
| Pin spacing             | 7.5/7.62 mm / 0.295/0.3 inches |
| Width                   | 39.8 mm / 1.567 inches         |
| Height                  | 17 mm / 0.669 inches           |
| Height from the surface | 13 mm / 0.512 inches           |
| Depth                   | 14 mm / 0.551 inches           |
| Solder pin length       | 4 mm                           |

Subject to changes. Please also observe the further product documentation!



|                                      |                          |
|--------------------------------------|--------------------------|
| Solder pin dimensions                | 0.7 x 0.7 mm             |
| Drilled hole diameter with tolerance | 1.1 <sup>(+0.1)</sup> mm |

### Plug-in connection

|                                      |    |
|--------------------------------------|----|
| Plugging without loss of pin spacing | No |
|--------------------------------------|----|

### PCB contact

|                                     |  |
|-------------------------------------|--|
| PCB contact                         | THT                                      |
| Solder pin arrangement              | over the entire terminal strip (in-line) |
| Number of solder pins per potential | 1  |

### Material Data

|                      |  |
|----------------------|--|
| Note (material data) | Information on material specifications can be found here |
|----------------------|--|

|                             |  |
|-----------------------------|--|
| Color                       | gray                                   |
| Material group              | I                                      |
| Insulation material         | Polyamide (PA66)                       |
| Flammability class per UL94 | V0                                     |
| Clamping spring material    | Chrome-nickel spring steel (CrNi)      |
| Contact material            | Electrolytic copper (E <sub>Cu</sub> ) |
| Contact plating             | Tin                                    |
| Fire load                   | 0.099 MJ                               |
| Weight                      | 5.5 g                                  |

### Environmental requirements

|                         |                 |
|-------------------------|-----------------|
| Limit temperature range | -60 ... +105 °C |
|-------------------------|-----------------|

### Commercial data

|                |                                |
|----------------|--------------------------------|
| Product Group  | 4 (Printed Circuit Connectors) |
| eCl@ss 10.0    | 27-44-04-01                    |
| eCl@ss 9.0     | 27-44-04-01                    |
| ETIM 8.0       | EC002643                       |
| ETIM 7.0       | EC002643                       |
| PU (SPU)       | 120 (30) pcs                   |
| Packaging type | box                            |

Subject to changes. Please also observe the further product documentation!

WAGO GmbH & Co. KG  
 Hansastr. 27  
 32423 Minden  
 Phone: +49571 887-0 | Fax: +49571 887-169  
 Email: [info.de@wago.com](mailto:info.de@wago.com) | Web: [www.wago.com](http://www.wago.com)

Do you have any questions about our products?  
 We are always happy to take your call at +49 (571) 887-44222.

|                       |               |
|-----------------------|---------------|
| Country of origin     | CH            |
| GTIN                  | 4044918767897 |
| Customs tariff number | 85369010000   |

## Environmental Product Compliance

|                        |                         |
|------------------------|-------------------------|
| RoHS Compliance Status | Compliant, No Exemption |
|------------------------|-------------------------|

## Approvals / Certificates

### General approvals

| Logo   | Approval                               | Additional Approval Text | Certificate name |
|--|--|--------------------------|------------------|
|  | <b>CSA</b><br>DEKRA Certification B.V. | C22.2 No. 158            | 1673957          |

### Approvals for marine applications





| Logo   | Approval                         | Additional Approval Text | Certificate name |
|--|----------------------------------|--------------------------|------------------|
|  | <b>BV</b><br>Bureau Veritas S.A. | IEC 60998                | 11915/D0<br>BV   |

## Optional accessories

### Stickers with operating instructions

| Stickers with operating instructions  |  |  |
|---|--|--|
|  | <b>Item no.: 210-191</b><br>Stickers for operating instructions; for PCB terminal blocks; 236 Series | <a href="http://www.wago.com/210-191">www.wago.com/210-191</a> |

### Ferrule

| Ferrule   |  |  |
|---|--|--|
|  | <b>Item no.: 216-101</b><br>Ferrule; Sleeve for 0.5 mm <sup>2</sup> / AWG 22; uninsulated; electro-tin plated; silver-colored  | <a href="http://www.wago.com/216-101">www.wago.com/216-101</a> |
|  | <b>Item no.: 216-104</b><br>Ferrule; Sleeve for 1.5 mm <sup>2</sup> / AWG 16; uninsulated; electro-tin plated; silver-colored  | <a href="http://www.wago.com/216-104">www.wago.com/216-104</a> |
|  | <b>Item no.: 216-102</b><br>Ferrule; Sleeve for 0.75 mm <sup>2</sup> / AWG 20; uninsulated; electro-tin plated; silver-colored | <a href="http://www.wago.com/216-102">www.wago.com/216-102</a> |
|  | <b>Item no.: 216-103</b><br>Ferrule; Sleeve for 1 mm <sup>2</sup> / AWG 18; uninsulated; electro-tin plated                    | <a href="http://www.wago.com/216-103">www.wago.com/216-103</a> |

Subject to changes. Please also observe the further product documentation!



|   |   |  |
|---|---|--|
|    | <b>Item no.: 216-123</b><br>Ferrule; Sleeve for 1 mm <sup>2</sup> / AWG 18; uninsulated; electro-tin plated; silver-colored   | <a href="http://www.wago.com/216-123">www.wago.com/216-123</a> |
|    | <b>Item no.: 216-122</b><br>Ferrule; Sleeve for 0.75 mm <sup>2</sup> / AWG 20; uninsulated; electro-tin plated; silver-colored  | <a href="http://www.wago.com/216-122">www.wago.com/216-122</a> |
|    | <b>Item no.: 216-124</b><br>Ferrule; Sleeve for 1.5 mm <sup>2</sup> / AWG 16; uninsulated; electro-tin plated   | <a href="http://www.wago.com/216-124">www.wago.com/216-124</a> |
|    | <b>Item no.: 216-142</b><br>Ferrule; Sleeve for 0.75 mm <sup>2</sup> / 18 AWG; uninsulated; electro-tin plated; electrolytic copper; gastight crimped; acc. to DIN 46228, Part 1/08.92                | <a href="http://www.wago.com/216-142">www.wago.com/216-142</a> |
|    | <b>Item no.: 216-132</b><br>Ferrule; Sleeve for 0.34 mm <sup>2</sup> / AWG 24; uninsulated; electro-tin plated  | <a href="http://www.wago.com/216-132">www.wago.com/216-132</a> |
|    | <b>Item no.: 216-121</b><br>Ferrule; Sleeve for 0.5 mm <sup>2</sup> / AWG 22; uninsulated; electro-tin plated; silver-colored   | <a href="http://www.wago.com/216-121">www.wago.com/216-121</a> |
|    | <b>Item no.: 216-143</b><br>Ferrule; Sleeve for 1 mm <sup>2</sup> / AWG 18; uninsulated; electro-tin plated; electrolytic copper; gastight crimped; acc. to DIN 46228, Part 1/08.92                   | <a href="http://www.wago.com/216-143">www.wago.com/216-143</a> |
|    | <b>Item no.: 216-131</b><br>Ferrule; Sleeve for 0.25 mm <sup>2</sup> / AWG 24; uninsulated; electro-tin plated; silver-colored  | <a href="http://www.wago.com/216-131">www.wago.com/216-131</a> |
|    | <b>Item no.: 216-141</b><br>Ferrule; Sleeve for 0.5 mm <sup>2</sup> / 20 AWG; uninsulated; electro-tin plated; electrolytic copper; gastight crimped; acc. to DIN 46228, Part 1/08.92                 | <a href="http://www.wago.com/216-141">www.wago.com/216-141</a> |
|  | <b>Item no.: 216-152</b><br>Ferrule; Sleeve for 0.34 mm <sup>2</sup> / AWG 24; uninsulated; electro-tin plated  | <a href="http://www.wago.com/216-152">www.wago.com/216-152</a> |
|  | <b>Item no.: 216-203</b><br>Ferrule; Sleeve for 1 mm <sup>2</sup> / AWG 18; insulated; electro-tin plated; red  | <a href="http://www.wago.com/216-203">www.wago.com/216-203</a> |
|  | <b>Item no.: 216-202</b><br>Ferrule; Sleeve for 0.75 mm <sup>2</sup> / 18 AWG; insulated; electro-tin plated; gray  | <a href="http://www.wago.com/216-202">www.wago.com/216-202</a> |
|  | <b>Item no.: 216-151</b><br>Ferrule; Sleeve for 0.25 mm <sup>2</sup> / AWG 24; uninsulated; electro-tin plated  | <a href="http://www.wago.com/216-151">www.wago.com/216-151</a> |
|  | <b>Item no.: 216-204</b><br>Ferrule; Sleeve for 1.5 mm <sup>2</sup> / AWG 16; insulated; electro-tin plated; black  | <a href="http://www.wago.com/216-204">www.wago.com/216-204</a> |
|  | <b>Item no.: 216-144</b><br>Ferrule; Sleeve for 1.5 mm <sup>2</sup> / AWG 16; uninsulated; electro-tin plated; electrolytic copper; gastight crimped; acc. to DIN 46228, Part 1/08.92; silver-colored | <a href="http://www.wago.com/216-144">www.wago.com/216-144</a> |
|  | <b>Item no.: 216-201</b><br>Ferrule; Sleeve for 0.5 mm <sup>2</sup> / 20 AWG; insulated; electro-tin plated; white  | <a href="http://www.wago.com/216-201">www.wago.com/216-201</a> |
|  | <b>Item no.: 216-223</b><br>Ferrule; Sleeve for 1 mm <sup>2</sup> / AWG 18; insulated; electro-tin plated; red  | <a href="http://www.wago.com/216-223">www.wago.com/216-223</a> |
|  | <b>Item no.: 216-241</b>  |  |

Subject to changes. Please also observe the further product documentation!

|   |  |  |
|---|--|--|
|   | Ferrule; Sleeve for 0.5 mm <sup>2</sup> / 20 AWG; insulated; electro-tin plated; electrolytic copper; gastight crimped; acc. to DIN 46228, Part 4/09.90; white                             | <a href="http://www.wago.com/216-241">www.wago.com/216-241</a> |
|    | <b>Item no.: 216-242</b><br>Ferrule; Sleeve for 0.75 mm <sup>2</sup> / 18 AWG; insulated; electro-tin plated; electrolytic copper; gastight crimped; acc. to DIN 46228, Part 4/09.90; gray | <a href="http://www.wago.com/216-242">www.wago.com/216-242</a> |
|    | <b>Item no.: 216-222</b><br>Ferrule; Sleeve for 0.75 mm <sup>2</sup> / 18 AWG; insulated; electro-tin plated; gray   | <a href="http://www.wago.com/216-222">www.wago.com/216-222</a> |
|    | <b>Item no.: 216-221</b><br>Ferrule; Sleeve for 0.5 mm <sup>2</sup> / 20 AWG; insulated; electro-tin plated; white   | <a href="http://www.wago.com/216-221">www.wago.com/216-221</a> |
|    | <b>Item no.: 216-224</b><br>Ferrule; Sleeve for 1.5 mm <sup>2</sup> / AWG 16; insulated; electro-tin plated; black   | <a href="http://www.wago.com/216-224">www.wago.com/216-224</a> |
|    | <b>Item no.: 216-243</b><br>Ferrule; Sleeve for 1 mm <sup>2</sup> / AWG 18; insulated; electro-tin plated; electrolytic copper; gastight crimped; acc. to DIN 46228, Part 4/09.90; red     | <a href="http://www.wago.com/216-243">www.wago.com/216-243</a> |
|    | <b>Item no.: 216-244</b><br>Ferrule; Sleeve for 1.5 mm <sup>2</sup> / AWG 16; insulated; electro-tin plated; electrolytic copper; gastight crimped; acc. to DIN 46228, Part 4/09.90; black | <a href="http://www.wago.com/216-244">www.wago.com/216-244</a> |
|    | <b>Item no.: 216-263</b><br>Ferrule; Sleeve for 1 mm <sup>2</sup> / AWG 18; insulated; electro-tin plated; electrolytic copper; gastight crimped; acc. to DIN 46228, Part 4/09.90; red     | <a href="http://www.wago.com/216-263">www.wago.com/216-263</a> |
|    | <b>Item no.: 216-264</b><br>Ferrule; Sleeve for 1.5 mm <sup>2</sup> / AWG 16; insulated; electro-tin plated; electrolytic copper; gastight crimped; acc. to DIN 46228, Part 4/09.90; black | <a href="http://www.wago.com/216-264">www.wago.com/216-264</a> |
|   | <b>Item no.: 216-284</b><br>Ferrule; Sleeve for 1.5 mm <sup>2</sup> / AWG 16; insulated; electro-tin plated; electrolytic copper; gastight crimped; acc. to DIN 46228, Part 4/09.90; black | <a href="http://www.wago.com/216-284">www.wago.com/216-284</a> |
|  | <b>Item no.: 216-262</b><br>Ferrule; Sleeve for 0.75 mm <sup>2</sup> / 18 AWG; insulated; electro-tin plated; electrolytic copper; gastight crimped; acc. to DIN 46228, Part 4/09.90; gray | <a href="http://www.wago.com/216-262">www.wago.com/216-262</a> |
|  | <b>Item no.: 216-301</b><br>Ferrule; Sleeve for 0.25 mm <sup>2</sup> / AWG 24; insulated; electro-tin plated; yellow   | <a href="http://www.wago.com/216-301">www.wago.com/216-301</a> |
|  | <b>Item no.: 216-321</b><br>Ferrule; Sleeve for 0.25 mm <sup>2</sup> / AWG 24; insulated; electro-tin plated; yellow   | <a href="http://www.wago.com/216-321">www.wago.com/216-321</a> |
|  | <b>Item no.: 216-322</b><br>Ferrule; Sleeve for 0.34 mm <sup>2</sup> / 22 AWG; insulated; electro-tin plated; light turquoise  | <a href="http://www.wago.com/216-322">www.wago.com/216-322</a> |
|  | <b>Item no.: 216-302</b><br>Ferrule; Sleeve for 0.34 mm <sup>2</sup> / 22 AWG; insulated; electro-tin plated; light turquoise  | <a href="http://www.wago.com/216-302">www.wago.com/216-302</a> |

#### Marking accessories

##### Marking strip

**Item no.: 210-332/750-020**

Marking strips; as a DIN A4 sheet; MARKED; 1-20 (80x); Height of marker strip: 3 mm; Strip length 182 mm; Horizontal marking; Self-adhesive; white

[www.wago.com/210-332/750-020](http://www.wago.com/210-332/750-020)

Subject to changes. Please also observe the further product documentation!

WAGO GmbH & Co. KG

Hansastr. 27

32423 Minden

Phone: +49571 887-0 | Fax: +49571 887-169

Email: [info.de@wago.com](mailto:info.de@wago.com) | Web: [www.wago.com](http://www.wago.com)

Do you have any questions about our products?

We are always happy to take your call at +49 (571) 887-44222.



**Item no.: 210-332/762-020**

Marking strips; as a DIN A4 sheet; MARKED; 1-20 (80x); Height of marker strip: 3 mm; Strip length 182 mm; Horizontal marking; Self-adhesive; white

[www.wago.com/210-332/762-020](http://www.wago.com/210-332/762-020)

## Tool

### Operating tool



**Item no.: 210-657**

Operating tool; Blade: 3.5 x 0.5 mm; with a partially insulated shaft; short; multicoloured

[www.wago.com/210-657](http://www.wago.com/210-657)



**Item no.: 210-658**

Operating tool; Blade: 3.5 x 0.5 mm; with a partially insulated shaft; angled; short; multicoloured

[www.wago.com/210-658](http://www.wago.com/210-658)



**Item no.: 210-720**

Operating tool; Blade: 3.5 x 0.5 mm; with a partially insulated shaft; multicoloured

[www.wago.com/210-720](http://www.wago.com/210-720)



**Item no.: 236-332**

Operating tool; natural

[www.wago.com/236-332](http://www.wago.com/236-332)



**Item no.: 236-335**

Operating tool; gray

[www.wago.com/236-335](http://www.wago.com/236-335)

## Testing and measuring

### Testing accessories



**Item no.: 231-161**

Testing plug module with contact stud; for 236 Series; Pin spacing 7.5 mm / 0.295 in; 2,50 mm<sup>2</sup>; gray

[www.wago.com/231-161](http://www.wago.com/231-161)



**Item no.: 231-125**

Testing plug module with contact stud; Pin spacing 7.62 mm / 0.3 in; 2,50 mm<sup>2</sup>; orange

[www.wago.com/231-125](http://www.wago.com/231-125)

## Downloads

### Documentation

#### Additional Information

|  |            |          |          |
|--|------------|----------|----------|
| Technical Section                          | 2019 Apr 3 | pdf      | Download |
| Technical explanations                     |            | 2.0 MB   |          |
| Gebrückte Klemmenleisten für Leiterplatten |            | pdf      | Download |
|  |            | 187.6 kB |          |

Subject to changes. Please also observe the further product documentation!





## CAD/CAE-Data

### CAD data

|                      |                     |                          |
|----------------------|---------------------|--------------------------|
| 2D/3D Models 236-205 | <a href="#">URL</a> | <a href="#">Download</a> |
|----------------------|---------------------|--------------------------|

---

### PCB Design

|                              |                     |                          |
|------------------------------|---------------------|--------------------------|
| Symbol and Footprint 236-205 | <a href="#">URL</a> | <a href="#">Download</a> |
|------------------------------|---------------------|--------------------------|

CAX data for your PCB design, consisting of "schematic symbols and PCB footprints", allow easy integration of the WAGO component into your development environment.

### Supported formats:

- Accel EDA 14 & 15
- Altium 6 to current version
- Cadence Allegro
- DesignSpark
- Eagle Libraries
- KiCad
- Mentor Graphics BoardStation
- Mentor Graphics Design Architect
- Mentor Graphics Design Expedition 99 and 2000
- OrCAD 9.X PCB and Capture
- PADS PowerPCB 3, 3.5, 4.X, and 5.X
- PADS PowerPCB and PowerLogic 3.0
- PCAD 2000, 2001, 2002, 2004, and 2006
- Pulsonix 8.5 or newer
- STL
- 3D STEP
- TARGET 3001!
- View Logic ViewDraw
- Quadcept
- Zuken CadStar 3 and 4
- Zuken CR-5000 and CR-8000

PCB Component Libraries (EDA), PCB CAD Library Ultra Librarian

---

### CAE data

|                      |                     |                          |
|----------------------|---------------------|--------------------------|
| ZUKEN Portal 236-205 | <a href="#">URL</a> | <a href="#">Download</a> |
|----------------------|---------------------|--------------------------|

---

Subject to changes. Please also observe the further product documentation!

## Environmental Product Compliance

### Compliance Search

Environmental Product Compliance 236-205

URL

Download

PCB terminal block; 2.5 mm<sup>2</sup>; Pin spacing 7.5/7.62 mm; 5-pole; CAGE CLAMP®; commoning option; 2,50 mm<sup>2</sup>; gray

## Installation Notes

### Conductor termination

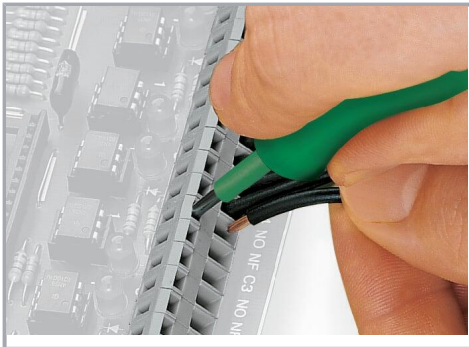

Inserting a conductor via 3.5 mm screwdriver.

Screwdriver actuation parallel to conductor entry

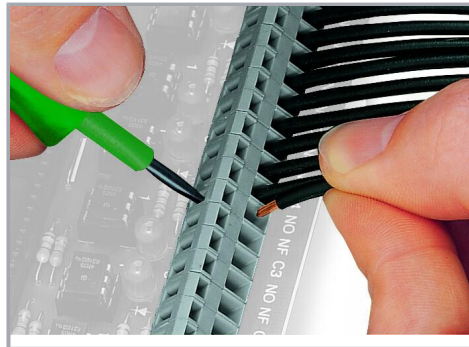

Inserting a conductor via 3.5 mm screwdriver.

Screwdriver actuation perpendicular to conductor entry

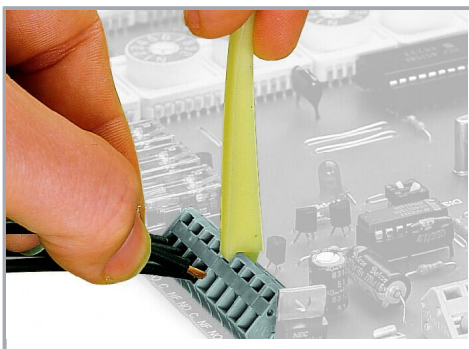

Inserting a conductor via operating tool.

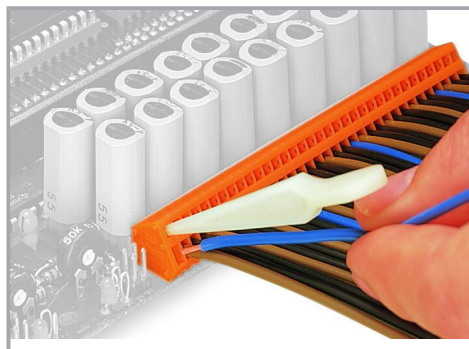

Compared to standard screwdrivers, these operating tools are far more convenient for wiring PCB terminal strips at factory.

### Installation

Subject to changes. Please also observe the further product documentation!

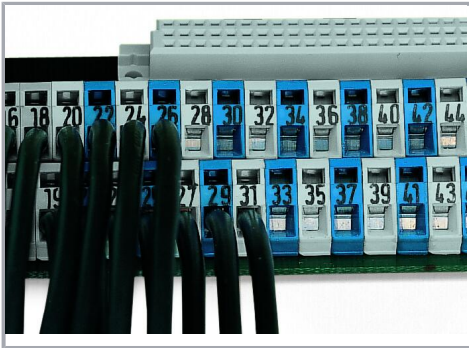

PCB Terminal Strips placed behind each other save space – staggering them by half the pin spacing simplifies subsequent wiring of the first row.

### Installation

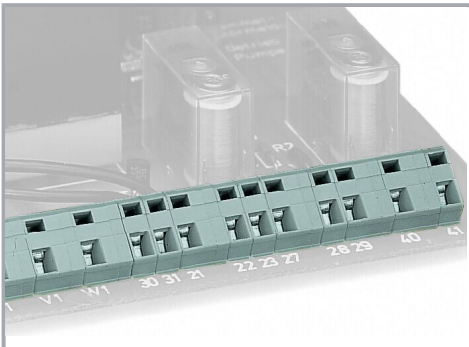

Combining PCB terminal blocks with different pin spacing.

### Marking

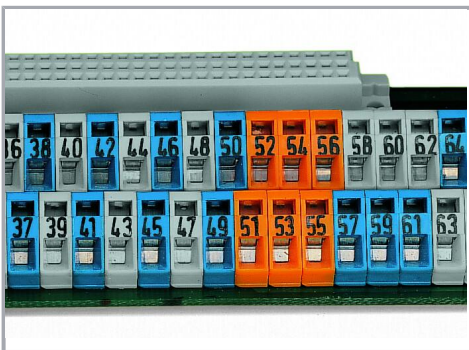

Optional: Labeling via factory direct marking.

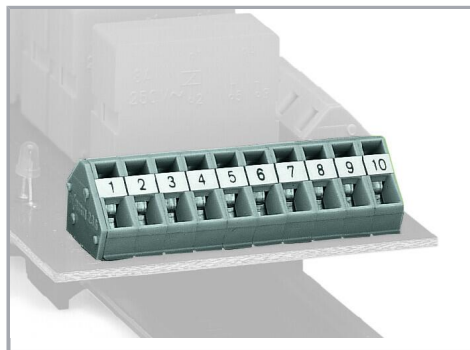

Optional: Labeling with self-adhesive marking strips possible

Subject to changes. Please also observe the further product documentation!