

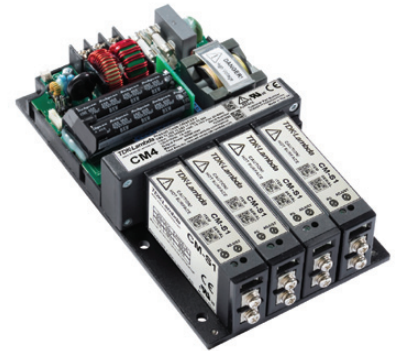

## 600W Conduction Cooled Modular Power Supply

Features	Benefits
• Conduction cooled	• No audible noise
• Wide output adjustment	• Suits non-standard voltages
• Compact 4 x 7 inch size	• Space saving in end equipment
• MIL-STD-461F compliant	• Suitable for COTS applications
• 5 year warranty	• Low cost of ownership
• External voltage control	• Remote programming of voltage and current



Specification			
Model	CM4 Series		
Output power (1)	W	425W	600W (750W for 5s)
Input voltage	Vac	85 - 264Vac	120-264Vac
Frequency	-	47 - 63Hz (Contact factory for operation on 400Hz)	
Input fuses	-	8A / 250Vac HBC Fast acting (not user accessible) in both Live and Neutral lines	
Input current at 120Vac, 600W load	A	6A	
Inrush current	-	<20A at 25 and 264Vac (cold start)	
Leakage current	A	200µA maximum at 264Vac 63Hz	
Power factor	-	0.99 typical	
Hold up	ms	Typically 20ms	
Over temperature protection	-	All outputs are turned off. After unit cools down, recycle AC or toggle global remote on/off	
Cooling	-	Conduction, convection or forced air	
Standby power consumption	W	Less than 1W with global on/off activated	
No load power consumption	W	10 to 21W	
Efficiency	-	Up to 90% (see application note on website)	
<b>Isolation</b>	-		
Input to output	-	Reinforced: 2 x MOPPs (3rd edition 60601), 4kVac	
Input to earth	-	Basic: 1 x MOPP 1.5kVac	
Output to earth	-	500Vdc	
Output to output	-	500Vdc	
<b>General</b>	-		
Weight	g	650 + 100 for each output module fitted	
Size (L x W x H)	mm	177.8 x 101.6 x 41	
Warranty	yrs	5	

**Notes:** (1) Converter and module power must be de-rated by 2.5% for every 3 volts below 120Vac, down to a minimum of 85Vac

## How To Create A Product Description

The extensive range of output modules and options make it possible to achieve almost any combination of Volts and Amps.

You can create your own CM configuration online at <https://config.emea.tdk-lambda.com/>. This method checks your configuration and offers the optimum solution. Alternatively, you can do this manually by using the guide below.

1. Select Output Modules from the table, based on output voltage and current. Ensure that the maximum number of slots does not exceed 4
2. For an S1 module set at 5V, S2 set at 12V, S3 set at 24V and a S4 set at 48V, please use the following nomenclature style: CM4 5S1 12S2 24S3 48S4
3. Contact TDK-Lambda to validate configuration

## Output Modules

Module Name	Slots used	Module	Output Voltage Minimum	Output Voltage Vnominal	Output Voltage Maximum	Maximum Output Current	Maximum Output	Maximum Peak Power (5 sec)
S1	1	-	1.5V	5V	7.5V	25A	125W	187.5W
Z1	2	2 x S1 in parallel	1.5V	5V	7.5V	50A	250W	375W
ZA	3	3 x S1 in parallel	1.5V	5V	7.5V	75A	375W	562.5W
ZN	4	4 x S1 in parallel	1.5V	5V	7.5V	100A	500W	750W
Y1	2	2 x S1 in series	3V	10V	15V	25A	250W	375W
HA	4	4 x S1 in series/parallel	3V	10V	15V	50A	500W	750W
S2	1	-	4.5V	12V	15V	15A	150W	225W
Z2	2	2 x S2 in parallel	4.5V	12V	15V	30A	300W	450W
YA	3	3 x S1 in series	4.5V	15V	22.5V	25A	375W	562.5W
ZB	3	3 x S2 in parallel	4.5V	12V	15V	45A	450W	675W
ZP	4	4 x S2 in parallel	4.5V	12V	15V	60A	600W	750W
YN	4	4 x S1 in series	6V	20V	30V	25A	500W	750W
S3	1	-	9V	24V	30V	7.5A	150W	225W
Y2	2	2 x S2 in series	9V	24V	30V	15A	300W	450W
ZC	3	3 x S3 in parallel	9V	24V	30V	22.5A	450W	675W
HB	4	4 x S2 in series/parallel	9V	24V	30V	30A	600W	750W
ZQ	4	4 x S3 in parallel	9V	24V	30V	30A	600W	750W
YB	3	3 x S2 in series	13.5V	36V	45V	15A	450W	675W
S4	1	-	18V	48V	58V	3.75A	150W	217.5W
Y3	2	2 x S3 in series	18V	48V	60V	7.5A	300W	450W
ZD	3	3 x S4 in parallel	18V	48V	58V	11.25A	450W	652.5W
ZR	4	4 x S4 in parallel	18V	48V	58V	15A	600W	750W
YP	4	4 x S2 in series	18V	48V	60V	15A	600W	750W
YC	3	3 x S3 in series	27V	72V	90V	7.5A	450W	675W
Y4	2	2 x S4 in series	36V	96V	116V	3.75A	300W	435W
YQ	4	4 x S3 in series	36V	96V	120V	7.5A	600W	750W
YD	3	3 x S4 in series	54V	144V	174V	3.75A	450W	652.5W
YR	4	4 x S4 in series	72V	192V	232V	3.75A	600W	750W

## Global Signals Specifications

Parameter	Details	Minimum	Typical	Maximum	Units
Bias Voltage		4.8	5	5.2	Volts
Bias Current				1	Amps
AC_OK Voltage	Low output level/High output level	0/4.8	0.03/5	0.1/5.2	Volts
AC_OK Current				10	mA
Power Good Voltage	Open collector output. Low output level. All slots. Absolute maximum = 6V	0.1		0.3	Volts
Power Good Current	Open collector output. Current sink only. All slots			50	mA
Tsns Voltage	Typical at 0°C internal temperature, 19.5mV/°C	0	0.4	5	Volts
Tsns Current				100	uA
Inhibit Voltage	Low input level/High input level. All slots	0/2.5		0.8/6	Volts
Inhibit Current	10k input impedance. All slots			1	mA

## Environment (see installation manual for more details) - Conduction Cooling

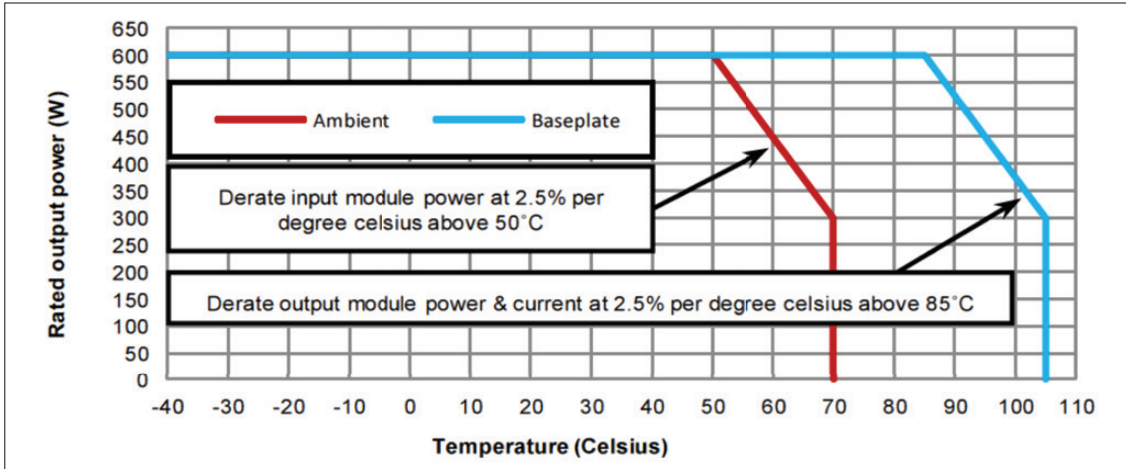

Apply appropriate derating to converter and modules for both ambient and baseplate temperatures  
See Note 1:

## Environment (see installation manual for more details) - Forced Air Cooling

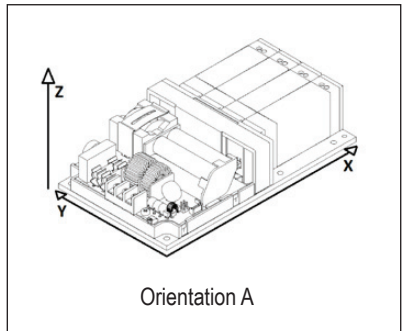
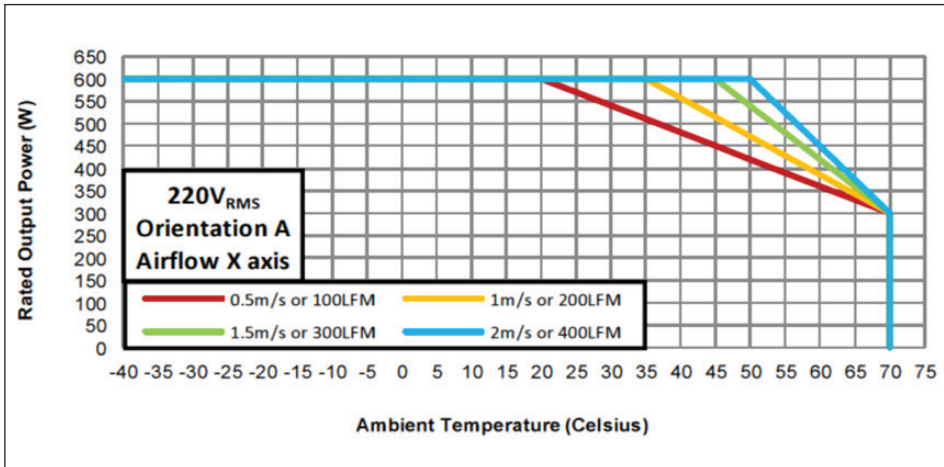

See Note 1:

## Environment (see installation manual for more details) - Convection Cooling

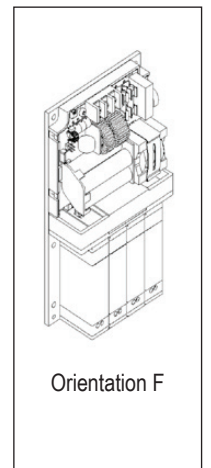
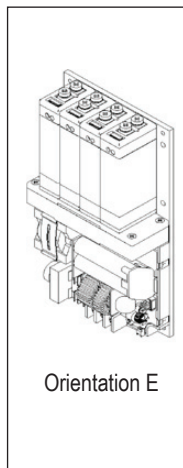
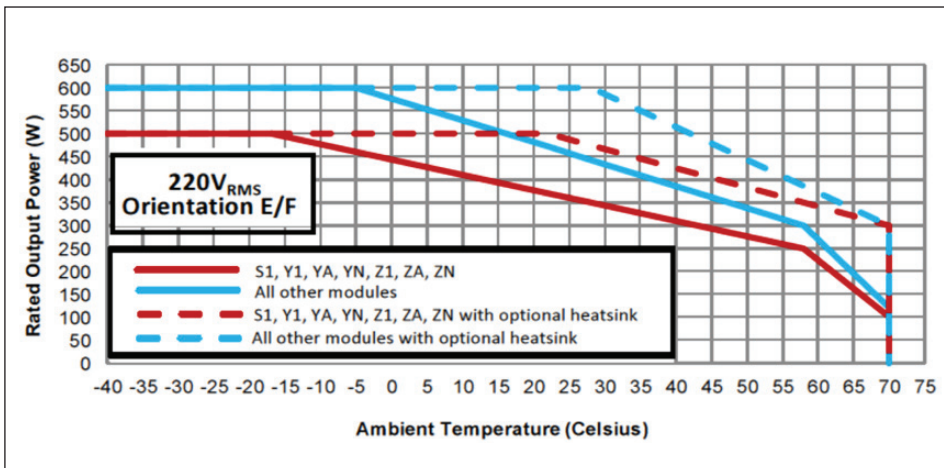

See Note 1:

**Note 1:** To ensure reliability, component temperatures must be maintained below recommended levels in the end application. The System cooling section of the user manual should be reviewed in detail and temperatures verified in the end application

Specification		
Note: Actual ratings must be determined in the user application		
Humidity (non condensing)		5 - 95%RH
Altitude		Operational: 3000m, storage: 5000m
Shock	EN 60068-2-27	30g 18ms operating, MIL-STD-810G: Method 516.6, Procedure IV
Vibration	EN 60068-2-6	Sine, 10 – 500 Hz, 3 axes, 1 oct/min., 10 cycles each axis
	EN 60068-2-64	Random, 5 – 500 Hz, 3 axes, 30 min.
	MIL-STD-810G	Method 514.6, Procedure I (General Vibration)
		Category 4 (Trucks & Trailers, Composite wheeled vehicle), Figure 514.6C-3. Category 7 (Aircraft, Jet cargo), Figure 514.6C-5 General exposure Category 24, (All, Minimum integrity) Figure 514.6E-1
Thermal shock (non operating)	MIL-STD-810G	Method 503.5 Procedure I-C. Multi-cycle. 3 shocks -51 to +85oC
<b>Emissions</b>		
Radiated electric field	EN55011/32	Class B
Radiated electric field, 30Hz-18GHz	MIL-STD-461F	RE102 (Ground, Fixed) when mounted in an enclosure
Conducted emissions	EN55011/32	FCC part 15, CISPR 22/11, Class B
Harmonic Distortion (PFC)	IEC61000-3-2	
Flicker & Fluctuation	IEC61000-3-3	
<b>Immunity</b>		
Electrostatic discharge	IEC61000-4-2	Test level 4: 15kV air, 8kV contact, IEC60601-1-2:2014
Radiated RF EM fields	IEC61000-4-3	Test Level 3: (10V/m, 80MHz-2.7GHz) sine wave AM 80% 1kHz
Proximity fields from RF	IEC61000-4-3	Test levels as per IEC60601-1-2:2014 Table 9
Radiated susceptibility, electric field	MIL-STD-461F	RS103 2 MHz to 40 GHz, 20V
Conducted susceptibility	MIL-STD-461F	CS115
Surge IEC61000-4-5		Test Level 3: 1kV L-N, 2kV L-E. As per IEC60601-1-2:2014
Conducted susceptibility	MIL-STD-461F	CS116
Shipboard electric power, voltage spike	MIL-STD-1399	“SECTION 300A, Type 1, 115V 60Hz single phase“
Conducted disturbances induced by RF fields	IEC61000-4-6	Test Level 3: 10V, 0.15 to 80MHz sine wave AM 80% 1kHz
Conducted susceptibility, power leads	MIL-STD-461F	CS101, 30Hz-150kHz
Conducted susceptibility, Bulk cable injection	MIL-STD-461F	CS114, 10kHz to 200MHz
Power Frequency Magnetic Fields	IEC61000-4-8	Test level 4: 30A/m 50Hz
Radiated susceptibility, Magnetic field	MIL-STD-461F	RS101
Voltage Dips	IEC61000-4-11	0% 10ms, 0% 20ms, 70% 0.5s (Criterion A) 40% 200mS (Criterion A at 240V and Criterion C at 100V)
Voltage Sag Immunity	SEMI-F47-0706	0% 20mS, 70% 0.5s, 80% 1s, 80% 10s, 90% continuous (Criterion A) 50% 200mS (Criterion A at 240V and Criterion C at 100V) Criterion A is achieved for full power when Vin >=160V Criterion A is achieved at all input voltages when Pout <= 350W
Voltage interruptions	IEC61000-4-11	0% 250/300 cycle as per IEC60601-1-2:2014 (Criterion C)
Aircraft Electric Power Characteristic	MIL-STD-704F	SAC102, 104, 105, 109, 110 (MIL-HDBK-704-2) SXF102, 104, 105, 109, 110 (MIL-HDBK-704-6)
<b>Safety certifications / accreditations</b>		IEC/UL/CSA/EN62368-1, 60950-1
		IEC/EN 60601-1, UL/CSA 60601-1, ANSI/AAMI ES60601-1
		CAN/CSA-C22.2 No 60601-1 CE Mark
		Manufactured under the control of ISO9001 and ISO13485 (including risk management)
<b>Global signals</b>		
Global bias supply		4.8 - 5.2V 1A
AC_OK signal		Open collector, high on fail
Global DC power good		Open collector, high on fail if any module is <90% of set voltage
Global inhibit/enable		Turns off or on all modules and the converter
Internal temperature sensor		0 to ~3V signal proportionate to converter transformer temperature

Output Specification				
<b>Module</b>	<b>S1</b>	<b>S2</b>	<b>S3</b>	<b>S4</b>
Vnom	5V	12V	24V	48V
Adjustment range	1.5 - 7.5V	4.5 - 15V	9 - 30V	18 - 58V
Turn on time	2s typical, 3s maximum			
Turn on rise time	<3.5ms (with resistive load) to 90% of voltage, monotonic rise above 10%			
Turn on overshoot	<0.1% of set voltage			
Ripple and noise	1% pk-pk of Vnom, using 20MHz bandwidth			
Voltage setting accuracy	+/-0.5% of factory set voltage			
Remote sense	Yes			
Minimum load	None			
Temperature coefficient	+/-0.02%/°C			
Load regulation (0-100% change)	+/-50mV	+/-100mV	+/-150mV	+/-300mV
Line regulation	+/-0.1% of Vnom for an 85-264Vac input change			
Cross regulation	+/-0.2% of Vnom			
Maximum transient deviation (25-75% change)	1V at 1A/μs	1.5V at 0.5A/μs	3V at 0.25A/μs	3V at 0.25A/μs
Transient recovery time	100μs recovery to within 10% of the output voltage set point			
Over voltage protection (typical)	9.5V	18V	36V	66V
Over current protection	105 - 125%			
Short circuit protection	Hiccup with auto recovery			
Over temperature protection	All outputs are turned off. After unit cools down, recycle AC or toggle global remote on/off			
<b>Module</b>	<b>Y1/HA</b>	<b>Y2/HB</b>	<b>Y3</b>	<b>Y4</b>
Vnom	10V	24V	48V	96V
Adjustment range	3 - 15V	9 - 30V	18 - 60V	36 - 116V
Turn on time	2s typical, 3s maximum			
Turn on rise time	<3.5ms (with resistive load) to 90% of voltage, monotonic rise above 10%			
Turn on overshoot	<0.1% of set voltage			
Ripple and noise	1% pk-pk of Vnom, using 20MHz bandwidth			
Voltage setting accuracy	+/-0.5% of factory set voltage			
Remote sense	Yes			
Minimum load	None			
Temperature coefficient	+/-0.02%/°C			
Load regulation (0-100% change)	+/-100mV	+/-200mV	+/-300mV	+/-600mV
Line regulation	+/-0.1% of Vnom for an 85-264Vac input change			
Cross regulation	+/-0.2% of Vnom			
Maximum transient deviation (25-75% change)	2V at 1A/μs	3V at 0.5A/μs	6V at 0.25A/μs	6V at 0.25A/μs
Transient recovery time	100μs recovery to within 10% of the output voltage set point			
Over voltage protection (typical)	19V	36V	72V	132V
Over current protection	105 - 125%			
Short circuit protection	Hiccup with auto recovery			
Over temperature protection	All outputs are turned off. After unit cools down, recycle AC or toggle global remote on/off			
<b>Module</b>	<b>YA</b>	<b>YB</b>	<b>YC</b>	<b>YD</b>
Vnom	15V	36V	72V	144V
Adjustment range	4.5 - 22.5V	13.5 - 45V	27 - 90V	54 - 174V
Turn on time	2s typical, 3s maximum			
Turn on rise time	<3.5ms (with resistive load) to 90% of voltage, monotonic rise above 10%			
Turn on overshoot	<0.1% of set voltage			
Ripple and noise	1% pk-pk of Vnom, using 20MHz bandwidth			
Voltage setting accuracy	+/-0.5% of factory set voltage			
Remote sense	Yes			
Minimum load	None			
Temperature coefficient	+/-0.02%/°C			
Load regulation (0-100% change)	+/-150mV	+/-300mV	+/-450mV	+/-900mV
Line regulation	+/-0.1% of Vnom for an 85-264Vac input change			
Cross regulation	+/-0.2% of Vnom			
Maximum transient deviation (25-75% change)	3V at 1A/μs	4.5V at 0.5A/μs	9V at 0.25A/μs	9V at 0.25A/μs
Transient recovery time	100μs recovery to within 10% of the output voltage set point			
Over voltage protection (typical)	28.5V	54V	108V	198V
Over current protection	105 - 125%			
Short circuit protection	Hiccup with auto recovery			
Over temperature protection	All outputs are turned off. After unit cools down, recycle AC or toggle global remote on/off			

Output Specification continued				
Module	YN	YP	YQ	YR
Vnom	20V	48V	96V	192V
Adjustment range	6 - 30V	18 - 60V	36 - 120V	72 - 232V
Turn on time	2s typical, 3s maximum			
Turn on rise time	<3.5ms (with resistive load) to 90% of voltage, monotonic rise above 10%			
Turn on overshoot	<0.1% of set voltage			
Ripple and noise	1% pk-pk of Vnom, using 20MHz bandwidth			
Voltage setting accuracy	+/-0.5% of factory set voltage			
Remote sense	Yes			
Minimum load	None			
Temperature coefficient	+/-0.02%/°C			
Load regulation (0-100% change)	+/-200mV	+/-400mV	+/-600mV	+/-1200mV
Line regulation	+/-0.1% of Vnom for an 85-264Vac input change			
Cross regulation	+/-0.2% of Vnom			
Maximum transient deviation (25-75% change)	1V at 1A/μs	1.5V at 0.5A/μs	3V at 0.25A/μs	3V at 0.25A/μs
Transient recovery time	100μs recovery to within 10% of the output voltage set point			
Over voltage protection (typical)	38V	72V	144V	264V
Over current protection	105 - 125%			
Short circuit protection	Hiccup with auto recovery			
Over temperature protection	All outputs are turned off. After unit cools down, recycle AC or toggle global remote on/off			
Module	Z1 / ZA / ZN	Z2 / ZB / ZP	ZC / ZQ	ZD / ZR
Vnom	5V	12V	24V	48V
Adjustment range	1.5 - 7.5V	4.5 - 15V	9 - 30V	18 - 58V
Turn on time	2s typical, 3s maximum			
Turn on rise time	<3.5ms (with resistive load) to 90% of voltage, monotonic rise above 10%			
Turn on overshoot	<0.1% of set voltage			
Ripple and noise	1% pk-pk of Vnom, using 20MHz bandwidth			
Voltage setting accuracy	+/-0.5% of factory set voltage			
Remote sense	Yes			
Minimum load	None			
Temperature coefficient	+/-0.02%/°C			
Load regulation (0-100% change)	+/-50mV	+/-100mV	+/-150mV	+/-300mV
Line regulation	+/-0.1% of Vnom for an 85-264Vac input change			
Cross regulation	+/-0.2% of Vnom			
Maximum transient deviation (25-75% change)	1V at 1A/μs	1.5V at 0.5A/μs	3V at 0.25A/μs	3V at 0.25A/μs
Transient recovery time	100μs recovery to within 10% of the output voltage set point			
Over voltage protection (typical)	9.5V	18V	36V	66V
Over current protection	105 - 125%			
Short circuit protection	Hiccup with auto recovery			
Over temperature protection	All outputs are turned off. After unit cools down, recycle AC or toggle global remote on/off			

Output signal, programming & bias supply	
Module good threshold	Open collector, off when output is below 90% of set point
Current monitor	The output current of the module can be measured using the ICONTROL signal
Remote Voltage Programming (S & Z modules only)	Adjusts the module set voltage by 0% to 131.5% with external 0 - 5V
Remote Current Programming (S & Z modules only)	Adjusts the module current limit point by 0% to 100% with external 0 to 4.5V
Current share accuracy	+/-5% for loads >20% of rating
Local bias supply	+4.2 - 5.V 10mA

## Screws

Location	Details	Penetration	Torque
Baseplate Mount: M1 – M6	Hole diameter = 5.00mm	4mm Baseplate thickness	0.55NM
Output Module Connection	M4	-	0.5NM
Input Module Connection	6 - 32	-	0.8NM

## Outline Drawing CM4 Series

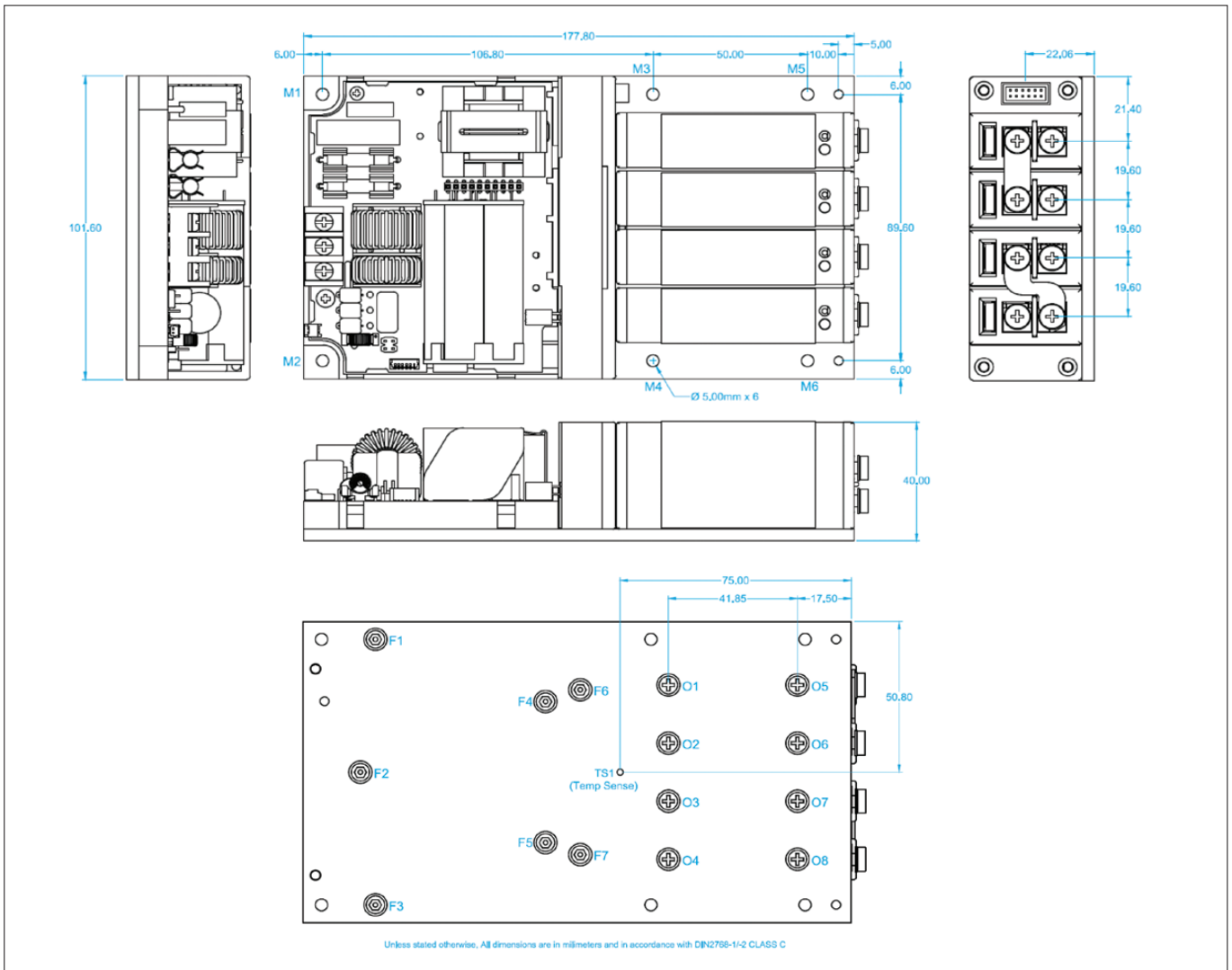

## Pinouts

Circuit	Details
<b>J1 – Mains Input</b>	
1	Live
2	Neutral
3	Earth
<b>J2 – Standby control</b>	
1	Standby control negative
2	Standby control positive
<b>J3 – Global Signals</b>	
1	Slot 4 - Power Good
2	Slot 4 - Inhibit
3	Slot 3 - Power Good
4	Slot 3 - Inhibit
5	Slot 2 - Power Good
6	Slot 2 - Inhibit
7	Slot 1 - Power Good
8	Slot 1 - Inhibit
9	Temperature sense (TSNS)
10	AC OK
11	+5V (Bias Supply 1A)
12	COM
<b>J4 – Output Signals</b>	
1	- Sense
2	+ Sense
3	COM
4	I Control
5	V Control
6	+5V (Bias Supply 10mA)

## Pinout CM4 Series

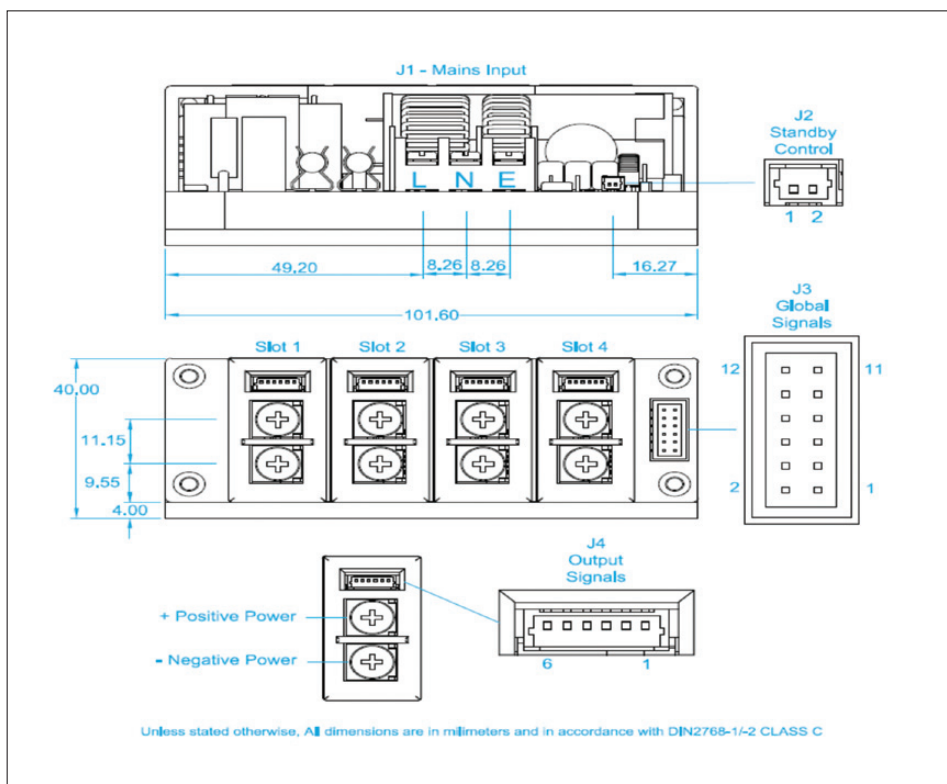



Mating Connectors					
Ref.	Details	Manufacturer	Housing	Terminal	
J1 - Mains Input	3 Pin, Barrier, 6-32 Steel Screws, 0.8 Nm or 7 Lb-In Torque (1)				
J2 - Standby control	2 Pin, 1.25mm, with Friction Lock, 28-30AWG	MOLEX	510210200	500588000	
J3 - Global Signals	12 Pin, 2mm, with Friction Lock, 24-30 AWG, WIRE TO BOARD	MOLEX	511101260	503948051	
	12 Pin, 2mm, with Friction Lock, 24-30 AWG, IDT CABLE TO BOARD	MOLEX	875681273		
J4 - Output Signals	6 PIN, 1.25mm, with Friction Lock, 28-30AWG	MOLEX	510210600	500588000	
Output Power	Positive/Negative, M4 terminal, use appropriately rated crimp terminal				

**Notes:**

1. Cable 14-18AWG, 300V, 16A, 105°C, use appropriately rated crimp terminal.
2. Direct equivalents may be used for any connector parts.
3. All cables must be rated 105°C min, equivalent to UL1015



## TDK-Lambda France SAS

3 Avenue du Canada  
Parc Technopolis  
Bâtiment Sigma  
91940 les Ulis  
France  
Tel: +33 1 60 12 71 65  
Fax: +33 1 60 12 71 66  
france@fr.tdk-lambda.com  
www.emea.lambda.tdk.com/fr



## Italy Sales Office

Via Giacomo Matteotti 62  
20092 Cinisello Balsamo (MI)  
Italy  
Tel: +39 02 61 29 38 63  
Fax: +39 02 61 29 09 00  
info.italia@it.tdk-lambda.com  
www.emea.lambda.tdk.com/it



## Netherlands

info@nl.tdk-lambda.com  
www.emea.lambda.tdk.com/nl



## TDK-Lambda Germany GmbH

Karl-Bold-Strasse 40  
77855 Achern  
Germany  
Tel: +49 7841 666 0  
Fax: +49 7841 5000  
info.germany@de.tdk-lambda.com  
www.emea.lambda.tdk.com/de



## Austria Sales Office

Aredstrasse 22  
2544 Leobersdorf  
Austria  
Tel: +43 2256 655 84  
Fax: +43 2256 645 12  
info@at.tdk-lambda.com  
www.emea.lambda.tdk.com/at



## Switzerland Sales Office

Eichtalstrasse 55  
8634 Hombrechtikon  
Switzerland  
Tel: +41 44 850 53 53  
Fax: +41 44 850 53 50  
info@ch.tdk-lambda.com  
www.emea.lambda.tdk.com/ch



## Nordic Sales Office

Haderslevvej 36B  
DK-6000 Kolding  
Denmark  
Tel: +45 8853 8086  
info@dk.tdk-lambda.com  
www.emea.lambda.tdk.com/dk



## TDK-Lambda UK Ltd.

Kingsley Avenue  
Ilfracombe  
Devon EX34 8ES  
United Kingdom  
Tel: +44 (0) 12 71 85 66 66  
Fax: +44 (0) 12 71 86 48 94  
info@uk.tdk-lambda.com  
www.emea.lambda.tdk.com/uk



## TDK-Lambda Ltd.

1 Alexander Yanai  
Segula  
Petah-Tikva  
Israel  
Tel: +9 723 902 4333  
Fax: +9 723 902 4777  
info@tdk-lambda.co.il  
www.emea.lambda.tdk.com/il



## C.I.S.

### Commercial Support:

Tel: +7 (495) 665 2627

### Technical Support:

Tel: +7 (812) 658 0463

info@tdk-lambda.ru

www.emea.lambda.tdk.com/ru

## Local Distribution

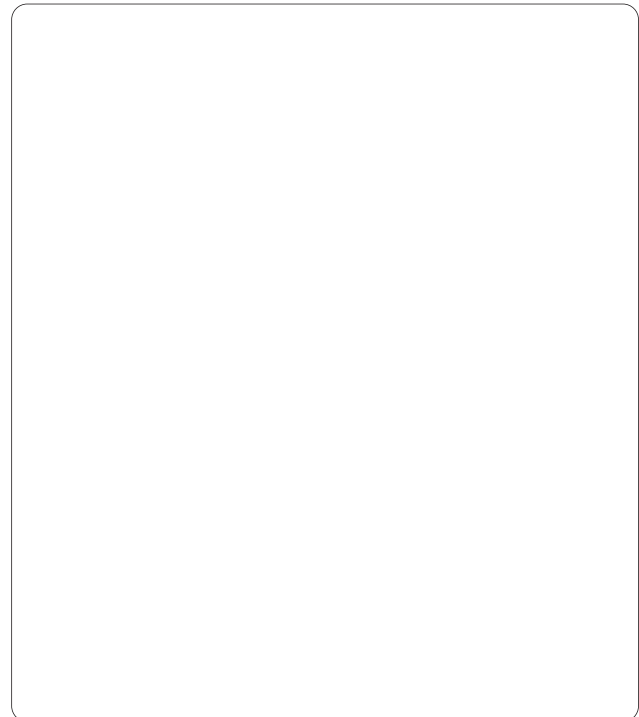

For additional information, please visit  
<https://product.tdk.com/en/power/>

