

Single relay - REL-OR3/L-120AC/3X21 - 2903695

Please be informed that the data shown in this PDF Document is generated from our Online Catalog. Please find the complete data in the user's documentation. Our General Terms of Use for Downloads are valid (<http://phoenixcontact.com/download>)



Pluggable octal relay with power contacts, 3 PDT, test button, mechanical switching position indication, coil voltage 120 V AC



Key Commercial Data

Packing unit	10 pc
Minimum order quantity	10 pc
GTIN	 4 046356 759083
GTIN	4046356759083

Technical data

Note

Note	The outputs are not suitable for switching different outer conductors.
	Do not use to separate SELV / PELV circuits from other circuits, because safe isolation is not guaranteed.

Dimensions

Width	35 mm
Height	35 mm
Depth	54.4 mm

Ambient conditions

Ambient temperature (operation)	-40 °C ... 55 °C
Ambient temperature (storage/transport)	-40 °C ... 85 °C
Maximum altitude	≤ 2000 m
Degree of protection	RT I
	≥ IP54 (Installation location)

Coil side

Nominal input voltage U_N	120 V AC
-----------------------------	----------

Single relay - REL-OR3/L-120AC/3X21 - 2903695

Technical data

Coil side

Mains frequency	50/60 Hz
Typical input current at U_N	23 mA
Typical response time	5 ms ... 15 ms (depending on phase relation)
Typical release time range	5 ms ... 20 ms (depending on phase relation)
Status display	Yellow LED
Coil resistance	1910 Ω \pm 15 %
Power dissipation for nominal condition	2.76 W

Contact side

Contact type	3 PDTs
Type of switch contact	Single contact
Contact material	AgNi
Maximum switching voltage	250 V DC 440 V AC
Minimum switching voltage	10 V (At 24 mA)
Min. switching current	10 mA (at 24 V)
Maximum inrush current	30 A (20 ms, N/O contact)
Limiting continuous current	10 A
Interrupting rating (ohmic load) max.	240 W (at 24 V DC) 124 W (at 48 V DC) 108 W (at 60 V DC) 52 W (at 110 V DC) 48 W (at 220 V DC) 2500 VA (for 250 V AC)
Motor load according to UL 508	1/2 HP, 240 V AC (N/O contact)

General

Test voltage relay winding/relay contact	2.5 kV _{rms} (50 Hz, 1 min.)
Test voltage PDT/PDT	2.5 kV _{rms} (50 Hz, 1 min.)
Operating mode	100% operating factor
Mechanical service life	approx. 2×10^7 cycles
Mounting position	any

Connection data

Connection method	Plug connection
-------------------	-----------------

Standards and Regulations

Connection in acc. with standard	CSA
Standards/regulations	IEC 60664 IEC 61810
Rated insulation voltage	250 V AC
Rated surge voltage	4 kV
Insulation	Basic insulation

Single relay - REL-OR3/L-120AC/3X21 - 2903695

Technical data

Standards and Regulations

Pollution degree	3
Overvoltage category	III

Environmental Product Compliance

China RoHS	Environmentally Friendly Use Period = 50
	For details about hazardous substances go to tab "Downloads", Category "Manufacturer's declaration"

Drawings

Diagram

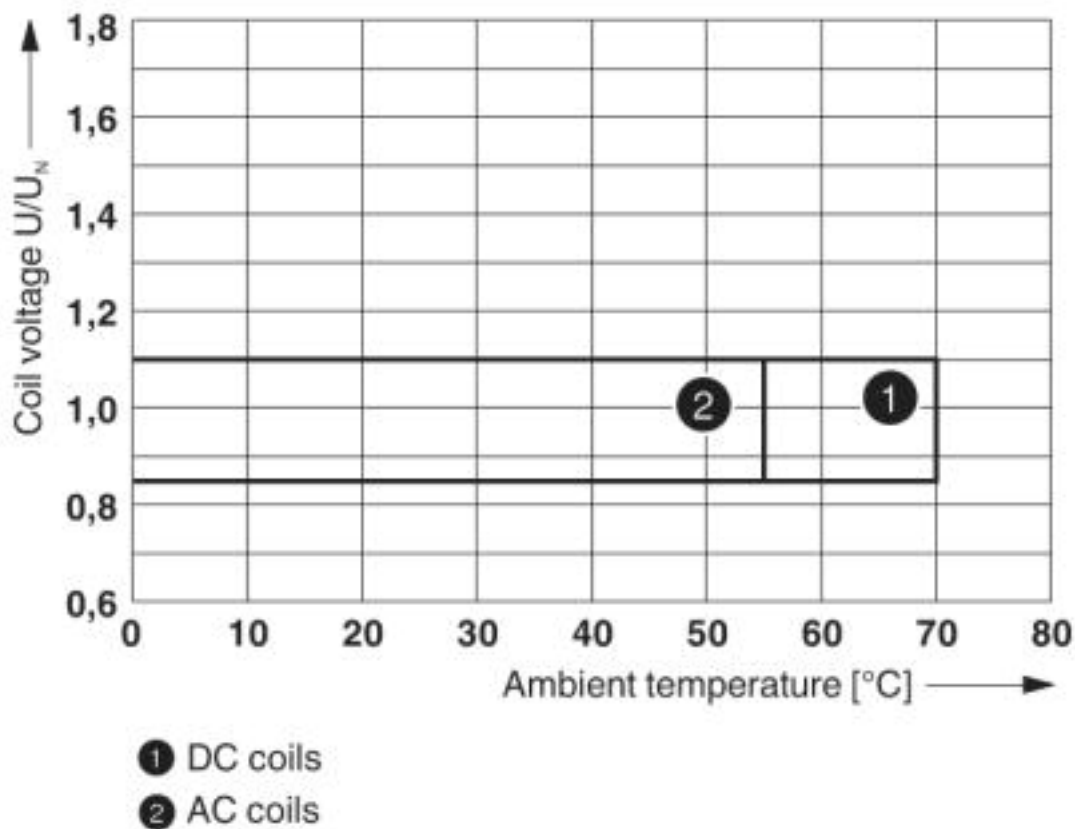

Operating voltage range

Single relay - REL-OR3/L-120AC/3X21 - 2903695

Diagram

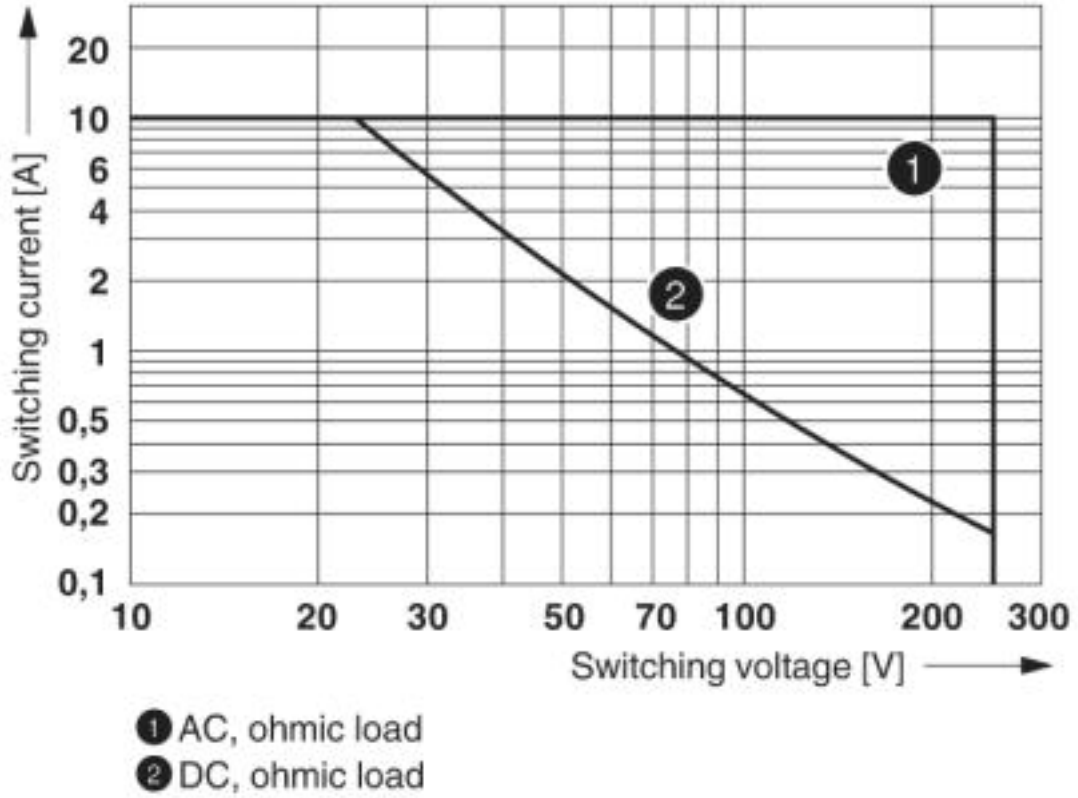

Interrupting rating

Single relay - REL-OR3/L-120AC/3X21 - 2903695

Diagram

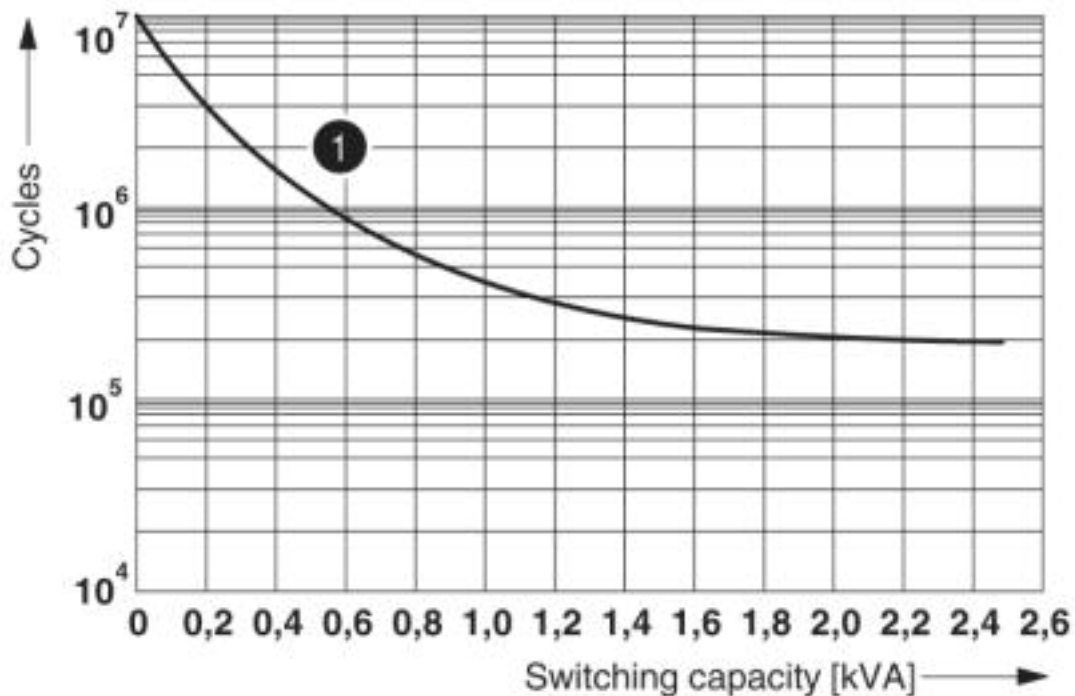

① 250 V AC, ohmic load

Electrical service life

Diagram

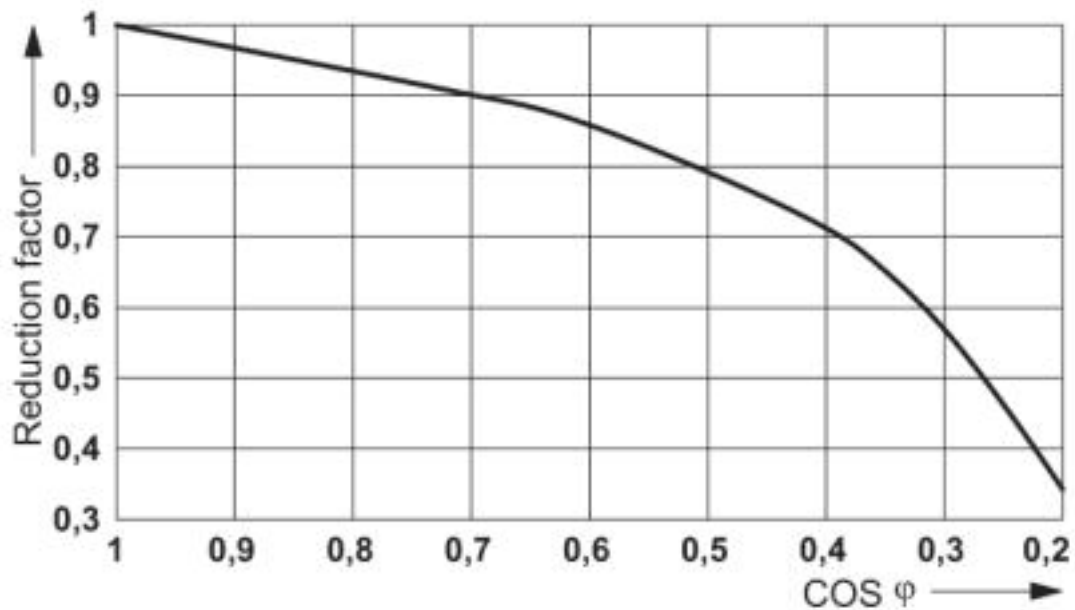

Service life reduction factor

Single relay - REL-OR3/L-120AC/3X21 - 2903695

Circuit diagram

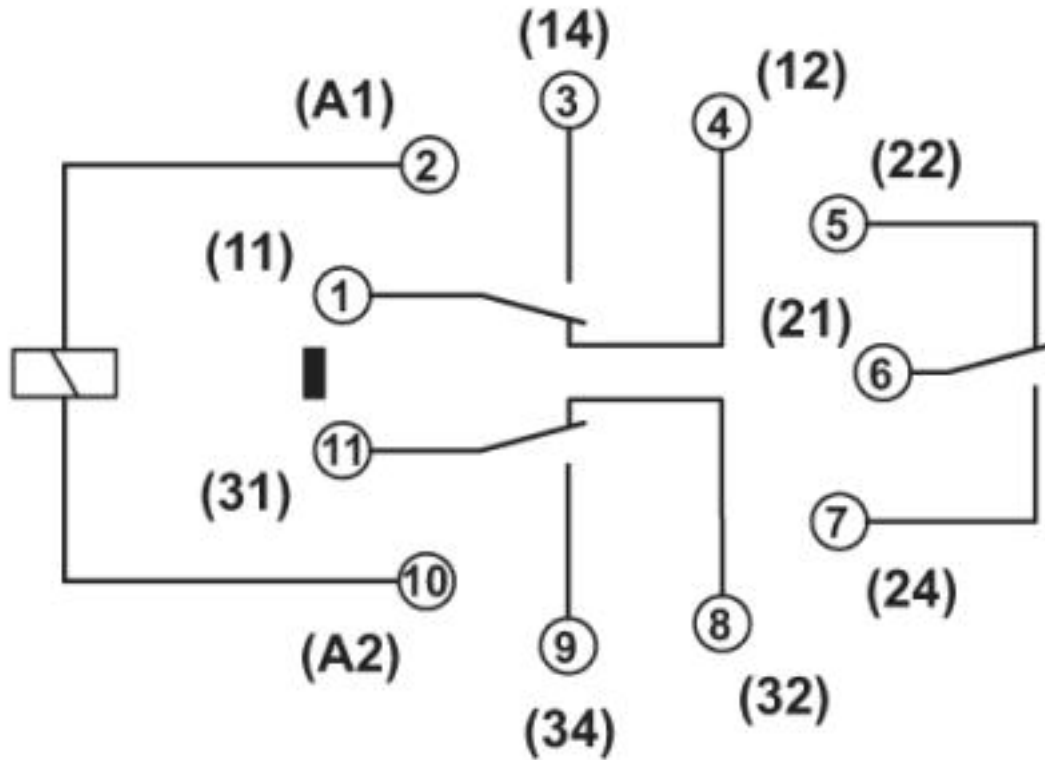

Approvals

Approvals

Approvals

CSA / UL Recognized / cUL Recognized / VDE Zeichengenehmigung / EAC / EAC / cULus Recognized

Ex Approvals





Approval details

CSA		http://www.csagroup.org/services-industries/product-listing/	2554095
-----	--	---	---------

UL Recognized		http://database.ul.com/cgi-bin/XYV/template/LISEXT/1FRAME/index.htm	FILE E 172140
---------------	--	---	---------------

Single relay - REL-OR3/L-120AC/3X21 - 2903695

Approvals

cUL Recognized		http://database.ul.com/cgi-bin/XYV/template/LISEXT/1FRAME/index.htm	FILE E 172140
VDE Zeichengenehmigung		http://www2.vde.com/de/Institut/Online-Service/VDE-gepruefteProdukte/Seiten/Online-Suche.aspx	40036588
EAC			TR_TS_D_00573_c
EAC			TR_TS_S_00010_c
cULus Recognized			

Phoenix Contact 2019 © - all rights reserved
<http://www.phoenixcontact.com>

PHOENIX CONTACT GmbH & Co. KG
Flachsmarktstr. 8
32825 Blomberg
Germany
Tel. +49 5235 300
Fax +49 5235 3 41200
<http://www.phoenixcontact.com>