

Data sheet | Item number: 281-613/281-541

2-conductor fuse terminal block; with pivoting fuse holder; for miniature metric fuse 1/4 x 1 mm; with blown fuse indication by LED; 15 - 30 V; for DIN-rail 35 x 15 and 35 x 7.5; 4 mm²; CAGE CLAMP®; 4,00 mm²; gray



www.wago.com/281-613/281-541



Color: —

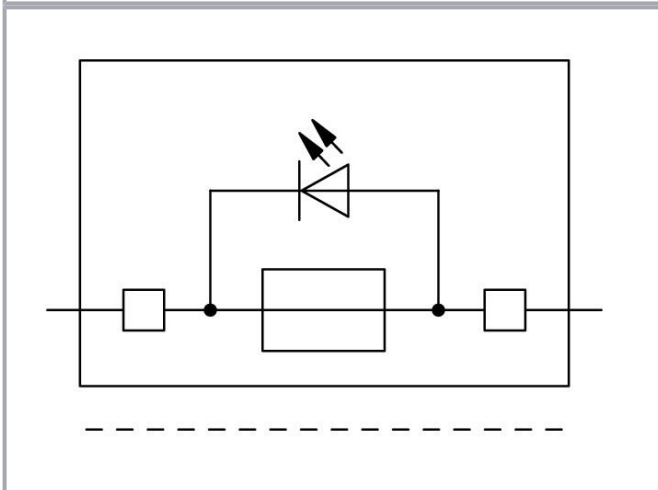
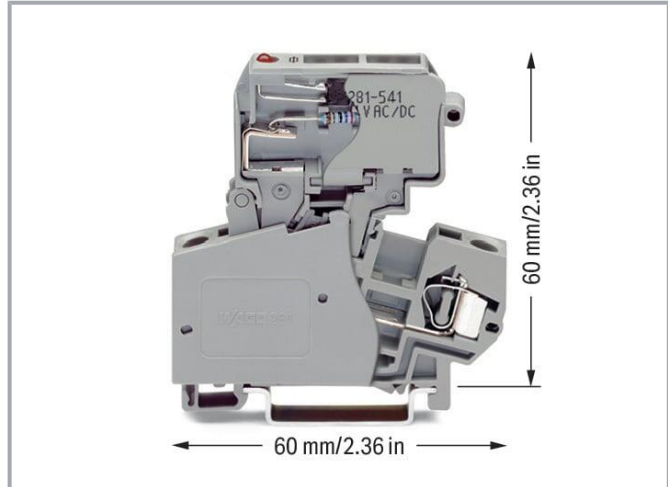

Subject to changes. Please also observe the further product documentation!

WAGO GmbH & Co. KG
Hansastr. 27
32423 Minden
Phone: +49571 887-0 | Fax: +49571 887-169
Email: info.de@wago.com | Web: www.wago.com

Do you have any questions about our products?
We are always happy to take your call at +49 (571) 887-44222.

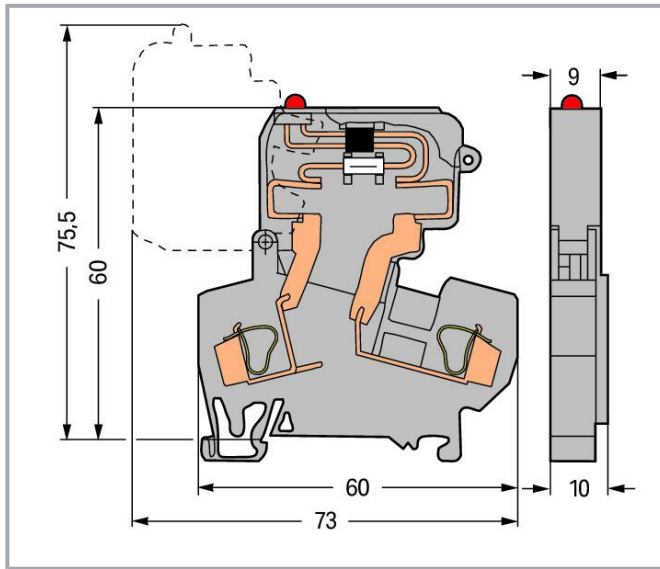

Data

Electrical data

Ratings per IEC/EN

Ratings per	IEC/EN 60947-7-3
Ratings (note)	Electrical ratings are given by the fuse and blown fuse indication.
Nominal voltage (III/3)	800 V
Rated impulse voltage (III/3)	8 kV
Rated current	10 A
Note (rated current)	Leakage current in case of a blown fuse: LED 6 mA
Operation status indicator	15 ... 30 V
Legend (ratings)	(III / 3) \triangleq Overvoltage category III / Pollution degree 3

Power loss

Power loss (max.) $P_{I(max.)}$ (note)	When selecting glass cartridge fuses, make sure that the maximum power loss listed below is not exceeded. The power loss is determined according to IEC or EN 60947-7-3/VDE 0611-6 at 23°C. The temperature rise of the terminal block must be checked according to their application and mounting. Higher ambient temperatures represent an additional impact on miniature fuses. Therefore, in such applications, the rated current must be reduced if necessary. More details are available from the manufacturers.
Power loss P_I max. overload and short-circuit protection (individual)	2.5 W

Subject to changes. Please also observe the further product documentation!



arrangement)	
Power loss P_I max. overload and short-circuit protection (group arrangement)	1.6 W
Power loss P_I max. short-circuit protection (individual arrangement)	4 W
Power loss P_I max. short-circuit protection (group arrangement)	2.5 W

General

Fuse receptacle	pivoting
Fuse type	Cylindrical fuse; 1/4" x 1"

Connection data

Connection points	2
Total number of potentials	2
Number of levels	1

Connection 1

Connection technology	CAGE CLAMP®
Actuation type	Operating tool
Connectable conductor materials	Copper Aluminum

Connectable conductor materials (note)

Terminating Aluminum Conductors

WAGO spring clamp terminal blocks are suitable for solid aluminum conductors up to 4 mm²/12 AWG if WAGO "Alu-Plus" Contact Paste 249-130 is used for termination.

"Alu-Plus" Contact Paste Advantages:

- Automatically destroys the oxide film during clamping.
- Prevents fresh oxidation at the clamping point.
- Prevents electrolytic corrosion between aluminum and copper conductors (in the same terminal block).
- Provides long-term protection against corrosion.

Subject to changes. Please also observe the further product documentation!



Using terminal blocks with CAGE CLAMP® Spring Pressure Connection Technology, **aluminum conductors must first be cleaned with a blade** and then immediately be inserted into the clamping units filled with "Alu-Plus" Contact Paste.

It is also possible to apply WAGO "Alu-Plus" **additionally** on the whole surface of the aluminum conductor before termination.

Please note that the nominal currents must be adapted to the reduced conductivity of the aluminum conductors::

2.5 mm² = 16 A

4 mm² = 22 A

Solid conductor	0.08 ... 4 mm ² / 28 ... 12 AWG
Fine-stranded conductor	0.08 ... 4 mm ² / 28 ... 12 AWG
Strip length	9 ... 10 mm / 0.35 ... 0.39 inches
Wiring direction	Front-entry wiring

Physical data

Width	10 mm / 0.394 inches
Height	60 mm / 2.362 inches
Depth from upper-edge of DIN-rail	60 mm / 2.362 inches

Mechanical Data

Design	angled
Mounting type	DIN-35 rail
Marking level	Center marking

Material Data

Note (material data)	Information on material specifications can be found here
Color	gray
Material group	I
Insulation material	Polyamide (PA66)
Flammability class per UL94	V0
Fire load	0.385 MJ
Weight	20.2 g

Subject to changes. Please also observe the further product documentation!

Environmental requirements

Processing temperature	-35 ... +85 °C
Continuous operating temperature	-60 ... +105 °C

Commercial data





Product Group	1 (Rail Mounted Terminal Blocks)
eCl@ss 10.0	27-14-11-16
eCl@ss 9.0	27-14-11-16
ETIM 8.0	EC000899
ETIM 7.0	EC000899
PU (SPU)	50 pcs
Packaging type	box
Country of origin	DE
GTIN	4045454319441
Customs tariff number	85369095000

Environmental Product Compliance

RoHS Compliance Status	Compliant, No Exemption
------------------------	-------------------------

Approvals / Certificates

General approvals



Logo	Approval	Additional Approval Text	Certificate name
	CSA DEKRA Certification B.V.	C22.2 No. 158	1505034
	KEMA/KEUR DEKRA Certification B.V.	EN 60947	NTR NL-7135
	KEMA/KEUR DEKRA Certification B.V.	EN 60947	2160584.31
	UR UL International Germany GmbH	UL 1059	E45172

Subject to changes. Please also observe the further product documentation!

Declarations of conformity and manufacturer's declarations





Logo	Approval	Additional Approval Text	Certificate name
	EU-Declaration of Conformity WAGO GmbH & Co. KG	-	-
	UK-Declaration of Conformity WAGO GmbH & Co. KG	-	-

Approvals for marine applications

Logo	Approval	Additional Approval Text	Certificate name
	ABS American Bureau of Shipping	-	20-HG1941090-PDA
	DNV GL Det Norske Veritas, Germanischer Lloyd	-	TAE00001V2

Optional accessories











Mounting

Cover carrier			
	Item no.: 709-167 Cover carrier; Type 1; incl. fixing/retaining screws and knurled nut; suitable for 279 to 282 and 880 Series rail-mounted terminal blocks; suitable for 264 Series miniature rail-mounted terminal blocks; suitable for 270 Series sensor and actuator terminal blocks; gray		www.wago.com/709-167
Cover			
	Item no.: 709-153 Cover; Type 1; suitable for cover carrier, type 1; 1 m long; transparent		www.wago.com/709-153
Mounting accessories			
	Item no.: 209-106 Mounting carrier; for isolated mounting on DIN 35 rails; gray		www.wago.com/209-106
	Item no.: 249-116 Screwless end stop; 6 mm wide; for DIN-rail 35 x 15 and 35 x 7.5; gray		www.wago.com/249-116

Subject to changes. Please also observe the further product documentation!

Marking accessories

Marker

	Item no.: 2009-115/000-002 WMB-Inline; for Smart Printer; 1500 pieces on roll; stretchable 5 - 5.2 mm; plain; snap-on type; yellow	www.wago.com/2009-115/000-002
	Item no.: 2009-115/000-007 WMB-Inline; for Smart Printer; 1500 pieces on roll; stretchable 5 - 5.2 mm; plain; snap-on type; gray	www.wago.com/2009-115/000-007
	Item no.: 2009-115/000-017 WMB-Inline; for Smart Printer; 1500 pieces on roll; stretchable 5 - 5.2 mm; plain; snap-on type; light green	www.wago.com/2009-115/000-017
	Item no.: 2009-115/000-023 WMB-Inline; for Smart Printer; 1500 pieces on roll; stretchable 5 - 5.2 mm; plain; snap-on type; green	www.wago.com/2009-115/000-023
	Item no.: 2009-115/000-024 WMB-Inline; for Smart Printer; 1500 pieces on roll; stretchable 5 - 5.2 mm; plain; snap-on type; violet	www.wago.com/2009-115/000-024
	Item no.: 2009-115 WMB-Inline; for Smart Printer; 1500 pieces on roll; stretchable 5 - 5.2 mm; plain; snap-on type; white	www.wago.com/2009-115
	Item no.: 793-5501/000-007 WMB marking card; as card; for terminal block width 5 - 17.5 mm; stretchable 5 - 5.2 mm; plain; snap-on type; gray	www.wago.com/793-5501/000-007
	Item no.: 793-5501/000-012 WMB marking card; as card; for terminal block width 5 - 17.5 mm; stretchable 5 - 5.2 mm; plain; snap-on type; orange	www.wago.com/793-5501/000-012
	Item no.: 793-5501/000-017 WMB marking card; as card; for terminal block width 5 - 17.5 mm; stretchable 5 - 5.2 mm; plain; snap-on type; light green	www.wago.com/793-5501/000-017
	Item no.: 793-5501/000-023 WMB marking card; as card; for terminal block width 5 - 17.5 mm; stretchable 5 - 5.2 mm; plain; snap-on type; green	www.wago.com/793-5501/000-023
	Item no.: 793-5501/000-024 WMB marking card; as card; for terminal block width 5 - 17.5 mm; stretchable 5 - 5.2 mm; plain; snap-on type; violet	www.wago.com/793-5501/000-024

Subject to changes. Please also observe the further product documentation!



Item no.: 793-501/000-002
WMB marking card; as card; not stretchable; plain; snap-on type; yellow

www.wago.com/793-501/000-002



Item no.: 793-501/000-007
WMB marking card; as card; not stretchable; plain; snap-on type; gray

www.wago.com/793-501/000-007



Item no.: 793-501/000-017
WMB marking card; as card; not stretchable; plain; snap-on type; light green

www.wago.com/793-501/000-017



Item no.: 793-501/000-012
WMB marking card; as card; not stretchable; plain; snap-on type; orange

www.wago.com/793-501/000-012



Item no.: 793-501/000-023
WMB marking card; as card; not stretchable; plain; snap-on type; green

www.wago.com/793-501/000-023



Item no.: 793-501/000-006
WMB marking card; as card; not stretchable; plain; snap-on type; blue

www.wago.com/793-501/000-006

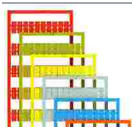

Item no.: 793-501/000-005
WMB marking card; as card; not stretchable; plain; snap-on type; red

www.wago.com/793-501/000-005



Item no.: 793-501
WMB marking card; as card; not stretchable; plain; snap-on type; white

www.wago.com/793-501



Item no.: 793-501/000-024
WMB marking card; as card; not stretchable; plain; snap-on type; violet

www.wago.com/793-501/000-024



Item no.: 793-5501/000-005
WMB marking card; as card; for terminal block width 5 - 17.5 mm; stretchable 5 - 5.2 mm; plain; snap-on type; red

www.wago.com/793-5501/000-005



Item no.: 793-5501/000-002
WMB marking card; as card; for terminal block width 5 - 17.5 mm; stretchable 5 - 5.2 mm; plain; snap-on type; yellow

www.wago.com/793-5501/000-002

Subject to changes. Please also observe the further product documentation!



Item no.: 793-5501/000-006

WMB marking card; as card; for terminal block width 5 - 17.5 mm; stretchable 5 - 5.2 mm; plain; snap-on type; blue www.wago.com/793-5501/000-006



Item no.: 793-5501

WMB marking card; as card; for terminal block width 5 - 17.5 mm; stretchable 5 - 5.2 mm; plain; snap-on type; white www.wago.com/793-5501



Item no.: 2009-115/000-012

WMB-Inline; for Smart Printer; 1500 pieces on roll; stretchable 5 - 5.2 mm; plain; snap-on type; orange www.wago.com/2009-115/000-012



Item no.: 2009-115/000-006

WMB-Inline; for Smart Printer; 1500 pieces on roll; stretchable 5 - 5.2 mm; plain; snap-on type; blue www.wago.com/2009-115/000-006

Push-in type wire jumper

Jumper



Item no.: 249-123

Push-in type wire jumper; 0.75 mm²; insulated; 180 mm long; black www.wago.com/249-123

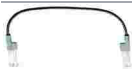

Item no.: 249-126

Push-in type wire jumper; 0.75 mm²; insulated; 110 mm long; black www.wago.com/249-126



Item no.: 249-127

Push-in type wire jumper; 0.75 mm²; insulated; 250 mm long; black www.wago.com/249-127



Item no.: 249-125

Push-in type wire jumper; insulated; 60 mm long; black www.wago.com/249-125

Locking levers

Locking system



Item no.: 210-254

Interlocking link; mechanically locks multiple links; 1 m long; transparent www.wago.com/210-254

End plate

End plate

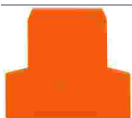

Item no.: 281-309

End and intermediate plate; 2.5 mm thick; orange www.wago.com/281-309



Item no.: 281-311

End and intermediate plate; 2.5 mm thick; gray www.wago.com/281-311

Ferrule

Ferrule



Item no.: 216-106

Ferrule; Sleeve for 2.5 mm² / AWG 14; uninsulated; electro-tin plated; silver-colored www.wago.com/216-106

Subject to changes. Please also observe the further product documentation!

	Item no.: 216-203 Ferrule; Sleeve for 1 mm ² / AWG 18; insulated; electro-tin plated; red	www.wago.com/216-203
	Item no.: 216-206 Ferrule; Sleeve for 2.5 mm ² / AWG 14; insulated; electro-tin plated; blue	www.wago.com/216-206
	Item no.: 216-202 Ferrule; Sleeve for 0.75 mm ² / 18 AWG; insulated; electro-tin plated; gray	www.wago.com/216-202
	Item no.: 216-204 Ferrule; Sleeve for 1.5 mm ² / AWG 16; insulated; electro-tin plated; black	www.wago.com/216-204
	Item no.: 216-205 Ferrule; Sleeve for 2.08 mm ² / AWG 14; insulated; electro-tin plated; yellow	www.wago.com/216-205
	Item no.: 216-201 Ferrule; Sleeve for 0.5 mm ² / 20 AWG; insulated; electro-tin plated; white	www.wago.com/216-201
	Item no.: 216-241 Ferrule; Sleeve for 0.5 mm ² / 20 AWG; insulated; electro-tin plated; electrolytic copper; gastight crimped; acc. to DIN 46228, Part 4/09.90; white	www.wago.com/216-241
	Item no.: 216-242 Ferrule; Sleeve for 0.75 mm ² / 18 AWG; insulated; electro-tin plated; electrolytic copper; gastight crimped; acc. to DIN 46228, Part 4/09.90; gray	www.wago.com/216-242
	Item no.: 216-243 Ferrule; Sleeve for 1 mm ² / AWG 18; insulated; electro-tin plated; electrolytic copper; gastight crimped; acc. to DIN 46228, Part 4/09.90; red	www.wago.com/216-243
	Item no.: 216-244 Ferrule; Sleeve for 1.5 mm ² / AWG 16; insulated; electro-tin plated; electrolytic copper; gastight crimped; acc. to DIN 46228, Part 4/09.90; black	www.wago.com/216-244
	Item no.: 216-246 Ferrule; Sleeve for 2.5 mm ² / AWG 14; insulated; electro-tin plated; electrolytic copper; gastight crimped; acc. to DIN 46228, Part 4/09.90; blue	www.wago.com/216-246
	Item no.: 216-301 Ferrule; Sleeve for 0.25 mm ² / AWG 24; insulated; electro-tin plated; yellow	www.wago.com/216-301
	Item no.: 216-302 Ferrule; Sleeve for 0.34 mm ² / 22 AWG; insulated; electro-tin plated; light turquoise	www.wago.com/216-302

Jumpers

Jumper

	Item no.: 210-123 Wire commoning chain; insulated; blue	www.wago.com/210-123
	Item no.: 210-103 Wire commoning chain; insulated; black	www.wago.com/210-103
	Item no.: 281-402 Jumper; insulated; gray	www.wago.com/281-402
	Item no.: 709-110 Wire commoning chain; 2.5 mm ² ; insulated; black	www.wago.com/709-110

Subject to changes. Please also observe the further product documentation!

WAGO GmbH & Co. KG

Hansastr. 27

32423 Minden

Phone: +49571 887-0 | Fax: +49571 887-169

Email: info.de@wago.com | Web: www.wago.com

Do you have any questions about our products?

We are always happy to take your call at +49 (571) 887-44222.

**Item no.: 709-112**Wire commoning chain; 2.5 mm²; insulated; blackwww.wago.com/709-112**Item no.: 709-111**Wire commoning chain; 2.5 mm²; insulated; blackwww.wago.com/709-111

Testing and measuring

Testing accessories

**Item no.: 281-407**Test plug; 6 mm wide; Nominal current 24 A; for 0.08 mm² - 2.5 mm²; 2,50 mm²; graywww.wago.com/281-407**Item no.: 280-404**Test plug adapter; 5 mm wide; for test plug (2.3 mm Ø); suitable for 1.5 mm² - 4 mm² tbs; graywww.wago.com/280-404

Tool

Operating tool

**Item no.: 210-657**

Operating tool; Blade: 3.5 x 0.5 mm; with a partially insulated shaft; short; multicoloured

www.wago.com/210-657**Item no.: 210-658**

Operating tool; Blade: 3.5 x 0.5 mm; with a partially insulated shaft; angled; short; multicoloured

www.wago.com/210-658**Item no.: 210-720**

Operating tool; Blade: 3.5 x 0.5 mm; with a partially insulated shaft; multicoloured

www.wago.com/210-720

Carrier rail

Mounting accessories

**Item no.: 210-197**

Steel carrier rail; 35 x 15 mm; 1.5 mm thick; 2 m long; slotted; similar to EN 60715; silver-colored

www.wago.com/210-197**Item no.: 210-198**

Copper carrier rail; 35 x 15 mm; 2.3 mm thick; 2 m long; unslotted; according to EN 60715; copper-colored

www.wago.com/210-198**Item no.: 210-504**

Steel carrier rail; 35 x 7.5 mm; 1 mm thick; 2 m long; slotted; galvanized; according to EN 60715; silver-colored

www.wago.com/210-504**Item no.: 210-505**

Steel carrier rail; 35 x 7.5 mm; 1 mm thick; 2 m long; unslotted; galvanized; according to EN 60715; silver-colored

www.wago.com/210-505**Item no.: 210-506**

Steel carrier rail; 35 x 15 mm; 1.5 mm thick; 2 m long; unslotted; galvanized; similar to EN 60715; silver-colored

www.wago.com/210-506**Item no.: 210-508**

Subject to changes. Please also observe the further product documentation!

WAGO GmbH & Co. KG

Hansastr. 27

32423 Minden

Phone: +49571 887-0 | Fax: +49571 887-169

Email: info.de@wago.com | Web: www.wago.com

Do you have any questions about our products?

We are always happy to take your call at +49 (571) 887-44222.



Steel carrier rail; 35 x 15 mm; 1.5 mm thick; 2 m long; slotted; galvanized; similar to EN 60715; silver-colored

www.wago.com/210-508



Item no.: 210-113

Steel carrier rail; 35 x 7.5 mm; 1 mm thick; 2 m long; unslotted; according to EN 60715; silver-colored

www.wago.com/210-113

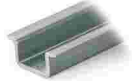

Item no.: 210-118

Steel carrier rail; 35 x 15 mm; 2.3 mm thick; 2 m long; unslotted; according to EN 60715; silver-colored

www.wago.com/210-118



Item no.: 210-112

Steel carrier rail; 35 x 7.5 mm; 1 mm thick; 2 m long; slotted; according to EN 60715; "Hole width 25 mm; silver-colored

www.wago.com/210-112



Item no.: 210-114

Steel carrier rail; 35 x 15 mm; 1.5 mm thick; 2 m long; unslotted; similar to EN 60715; silver-colored

www.wago.com/210-114



Item no.: 210-115

Steel carrier rail; 35 x 7.5 mm; 1 mm thick; 2 m long; slotted; according to EN 60715; "Hole width 18 mm; silver-colored

www.wago.com/210-115



Item no.: 210-196

Aluminum carrier rail; 35 x 8.2 mm; 1.6 mm thick; 2 m long; unslotted; similar to EN 60715; silver-colored

www.wago.com/210-196

Downloads

Documentation

Bid Text

281-613/281-541 X81 - Datei	2019 Feb 19	xml 3.7 kB	Download
281-613/281-541 doc - Datei	2017 Mar 14	doc 25.6 kB	Download

Additional Information

Technical Section Technical explanations		pdf 2.2 MB	Download
---	--	---------------	----------

CAD/CAE-Data

CAD data

2D/3D Models 281-613/281-541		URL	Download
------------------------------	--	-----	----------

CAE data

Subject to changes. Please also observe the further product documentation!

EPLAN Data Portal 281-613/281-541	URL	Download
WSCAD Universe 281-613/281-541	URL	Download
WSCAD Universe 281-613/281-541	URL	Download
ZUKEN Portal 281-613/281-541	URL	Download
EPLAN Data Portal 281-613/281-541	URL	Download

Environmental Product Compliance

Compliance Search

Environmental Product Compliance 281-613/281-541	URL	Download
--	---------------------	--------------------------

2-conductor fuse terminal block; with pivoting fuse holder; for miniature metric fuse 1 /4 x 1 mm; with blown fuse indication by LED; 15 - 30 V; for DIN-rail 35 x 15 and 35 x 7.5; 4 mm²; CAGE CLAMP®; 4,00 mm²; gray

Installation Notes

Conductor termination

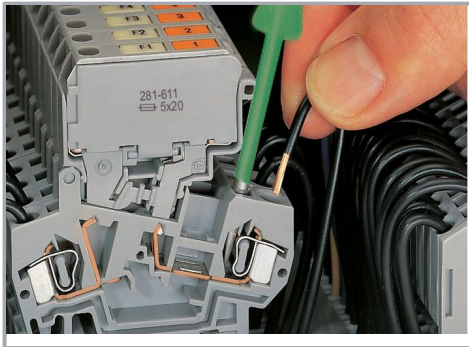

CAGE CLAMP® connection

Inserting a conductor.

With ferruled conductors, it is necessary to use a terminal block one size smaller than the conductor's nominal cross-section.

Commoning

Subject to changes. Please also observe the further product documentation!



Commoning

Distributing current to several fuse-protected circuits via insulated push-in type jumpers.

Testing

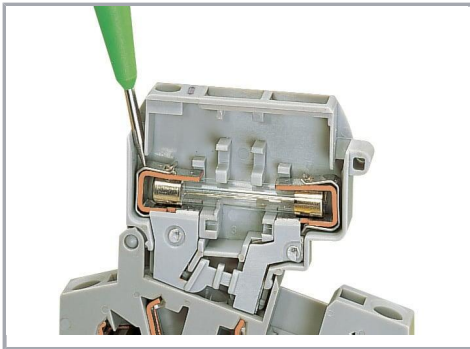

Voltage test, either at input or output with fuse holder in closed position (live)

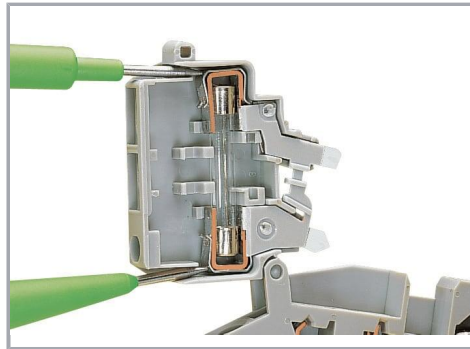

Through test with fuse holder in open position (no voltage)

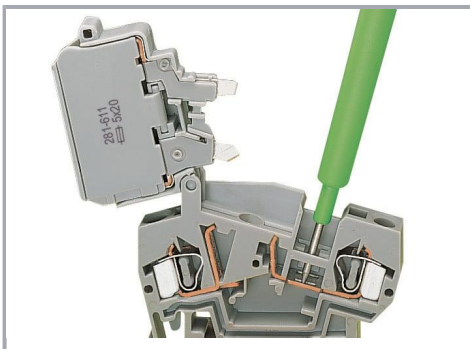

Voltage test at input in the test slot of the current bar

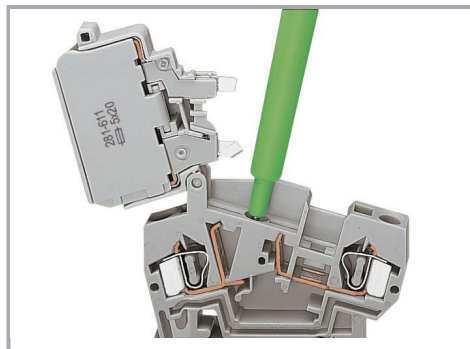

Testing voltage at the output via separate test slot.

Subject to changes. Please also observe the further product documentation!



Measuring current between jumper slot and separate test slot.

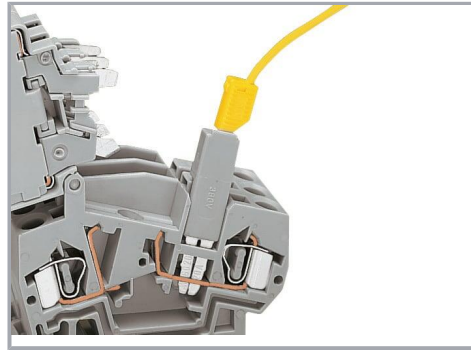

Testing voltage (input side) via test plug adapter (280-404, shown) or test plug (281-407).

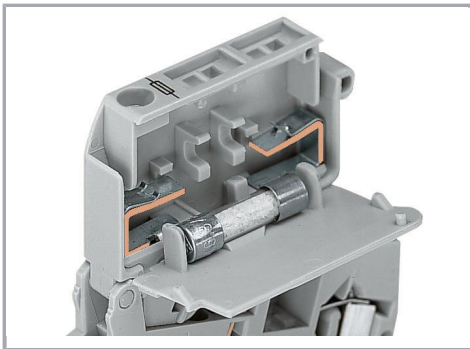

5 x 20 mm, 5 x 25 mm and 1/4" x 1" fuse holders are fitted with stops on the inside of the cover.

Security

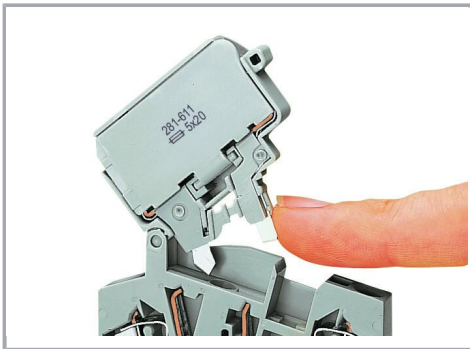

Touch-proof protection in all positions of the fuse holder



Fuse holder will remain safely locked open in vertical assemblies.

Locking system

Subject to changes. Please also observe the further product documentation!

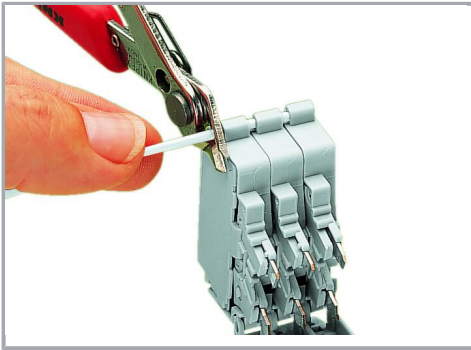

Ganging several fuse holders with an interlocking link (example shows 8 mm wide terminal blocks).



Fuse replacement:

Before replacing a fuse, pivot the fuse holder into the locked open position.

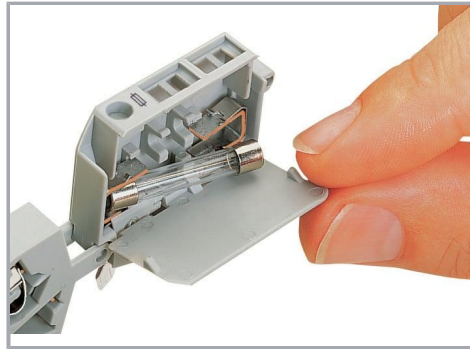

Fuse replacement:

One end of the fuse is automatically ejected from the holder when opening the cover.

Subject to changes. Please also observe the further product documentation!

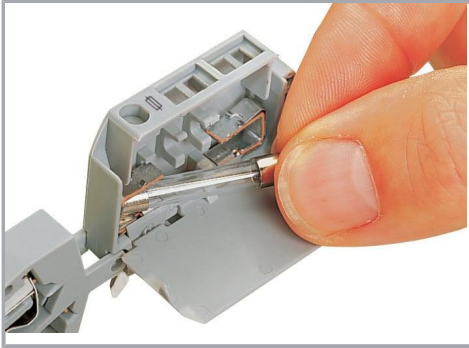

Fuse replacement:

Easily removing a fuse by hand.

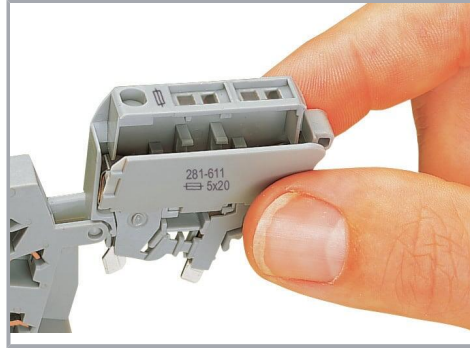

Fuse replacement:

Insert a new fuse and snap the cover closed.



Storing a spare fuse (fuse holder without blown fuse indication).

Subject to changes. Please also observe the further product documentation!

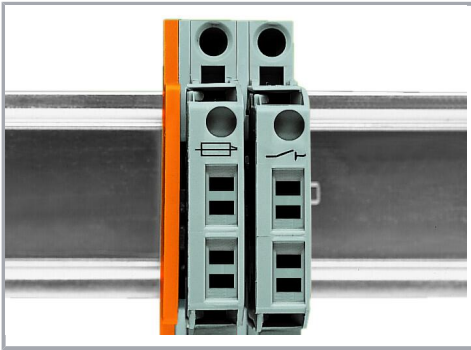

An intermediate plate is supplied with all 10 mm wide fused disconnect terminal blocks. At the end of an assembly, or if there is no adjacent fused disconnect terminal block, an end or intermediate plate must be used.

Marking



All fuse holders are printed with correct fuse size.



Each fuse holder features two marker slots for custom WMB Multi markers (example shows 8 mm wide terminal blocks).

Subject to changes. Please also observe the further product documentation!