

HCR Series Spare Part List



Updated on 2020.01.23



HCR spare parts price list (USD) - 2020 year

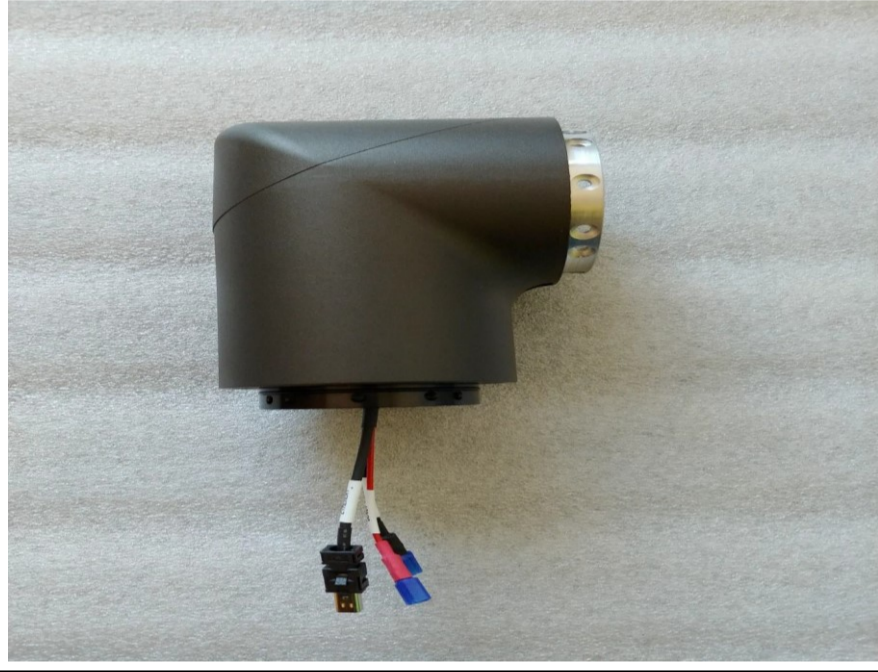

Incoterms: EXW

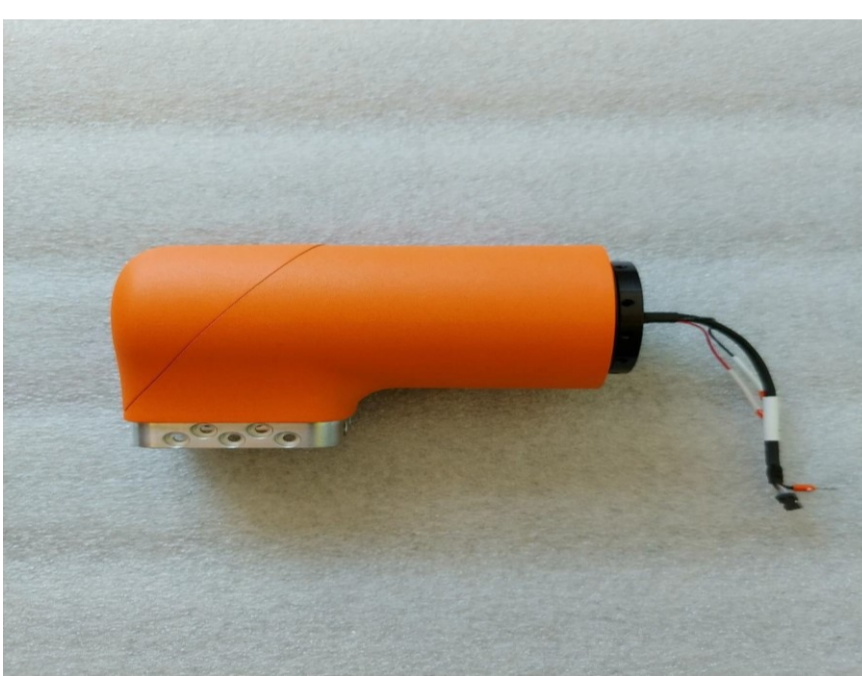

	Body	-----3
HCR-3	Controller	-----12
	TP	-----18
	Body	-----20
HCR-5	Controller	-----29
	TP	-----35
	Body	-----37
HCR-12	Controller	-----48
	TP	-----54

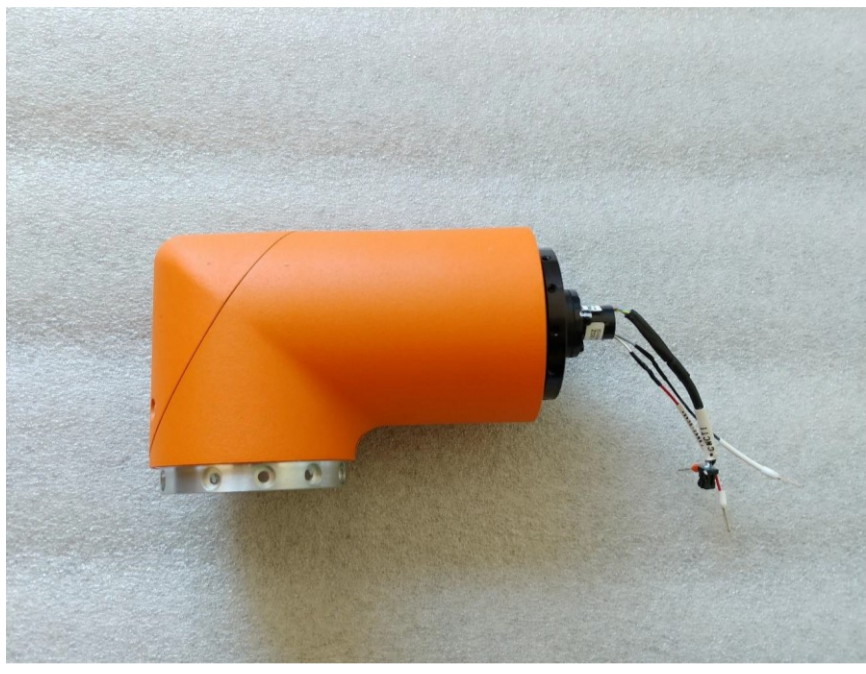

1. HCR-3 BODY

No.	Category(1)	Category(2)	Part Number	Part Name	Picture	Description
1	HCR-3	BODY	AM16-001732A	ASSY BASE-HCR3-J1_ASSY	 A black, L-shaped mechanical assembly with a cylindrical end and a connector with three wires (red, white, blue) extending from the bottom.	JOINT 1 ASS'Y
2	HCR-3	BODY	AM16-001731A	ASSY BASE-HCR3-J2_ASSY	 A black, L-shaped mechanical assembly with a cylindrical end and a connector with two wires (black, white) extending from the bottom.	JOINT 2 ASS'Y

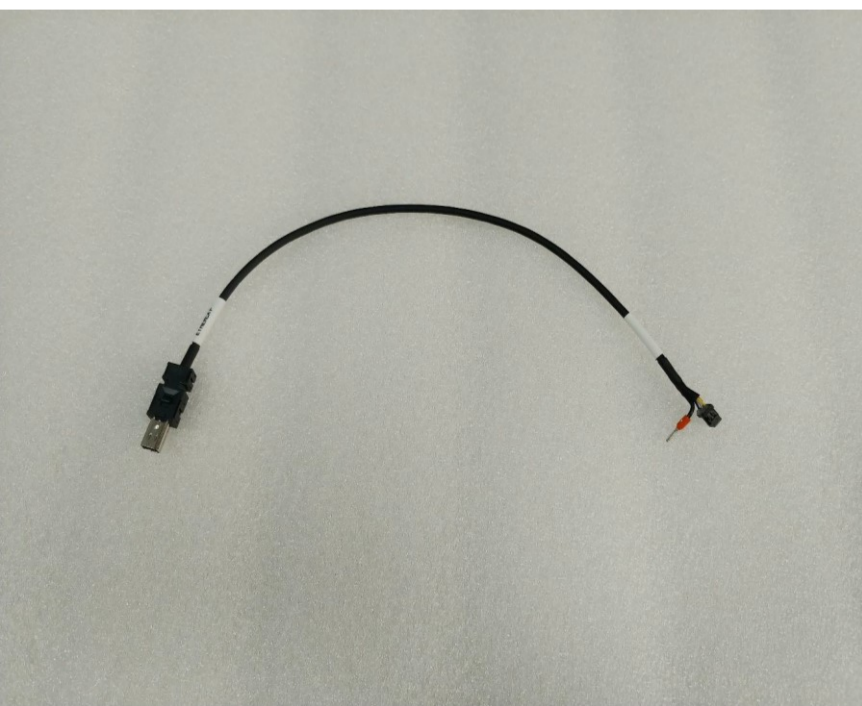

No.	Category(1)	Category(2)	Part Number	Part Name	Picture	Description
3	HCR-3	BODY	AM16-001734A	ASSY BASE-HCR3-J3_ASSY		JOINT 3 ASS'Y
4	HCR-3	BODY	AM16-001735A	ASSY BASE-HCR3-J4_ASSY		JOINT 4 ASS'Y
5	HCR-3	BODY	AM16-001737A	ASSY BASE-HCR3-J5_ASSY		JOINT 5 ASS'Y

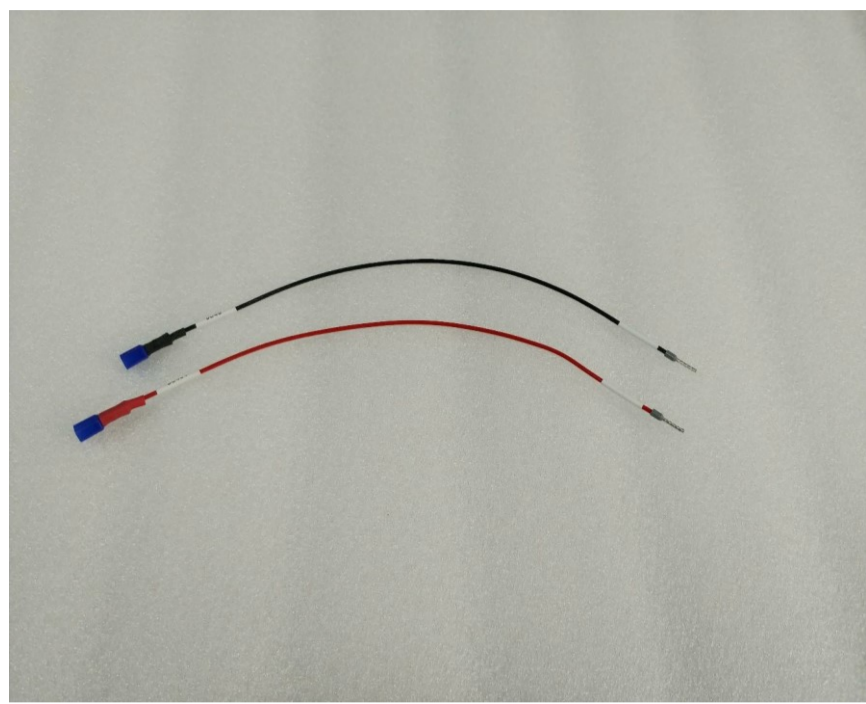
No.	Category(1)	Category(2)	Part Number	Part Name	Picture	Description
6	HCR-3	BODY	AM16-001739A	ASSY BASE-HCR3-J6_ASSY		JOINT 6 ASS'Y
7	HCR-3	BODY	AM16-001736A	ASSY BASE-HCR3-TOOL_IO_ASSY		TOOL ASS'Y
8	HCR-3	BODY	AM16-001819A	CABLE ASSY_MAIN_POWER_ECAT		BASE and Cable ASS'Y (It can't be seperated)

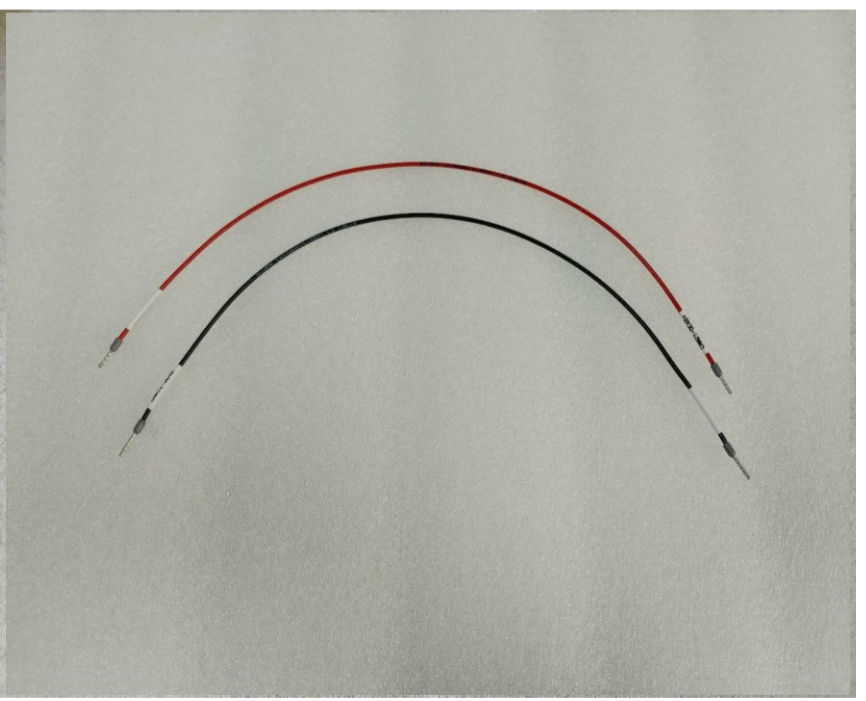
No.	Category(1)	Category(2)	Part Number	Part Name	Picture	Description
9	HCR-3	BODY	AM16-001972A	ASSY,BASE-HCR3_LED_RING_ASSY		LED RING
10	HCR-3	BODY	AM16-001766B	ASSY,CABLE-HCR03_EX_PWR_IO_B		TOOL I/O
11	HCR-3	BODY	AM16-001820A	ASSY,CABLE-HCR3_BASE-J1-ETHERCAT		Base-J1 Communication Cable

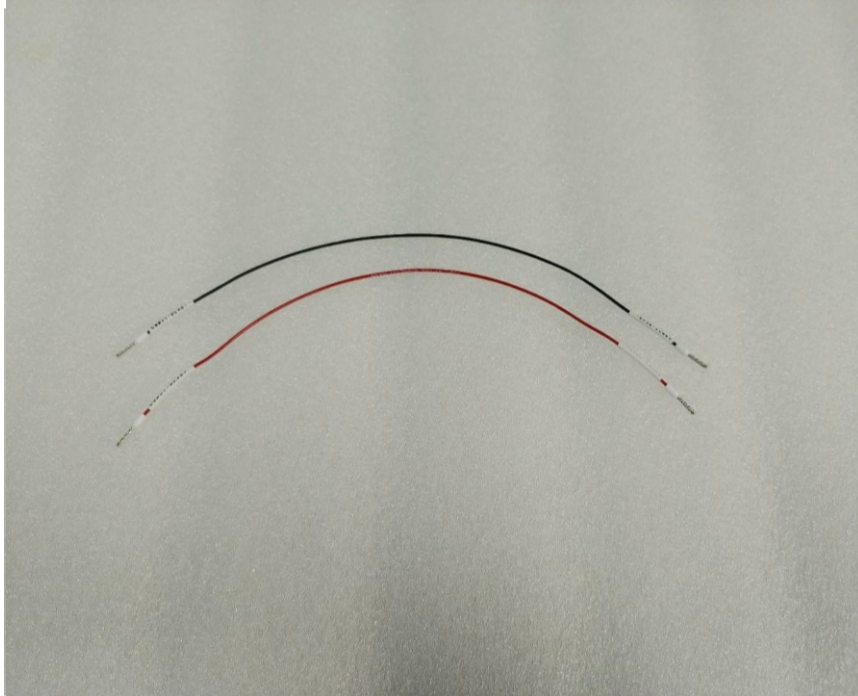
No.	Category(1)	Category(2)	Part Number	Part Name	Picture	Description
12	HCR-3	BODY	AM16-001821A	ASSY,CABLE-HCR3_BASE TO JOINT 1 POWER		Base-J1 Power Cable
13	HCR-3	BODY	AM16-001756A	ASSY,CABLE-CABLE-HCR03_J1-J2_ET		J1-J2 Communication Cable
14	HCR-3	BODY	AM16-001746A	ASSY,CABLE-HCR03_J1-J2_PWR		J1-J2 Power Cable

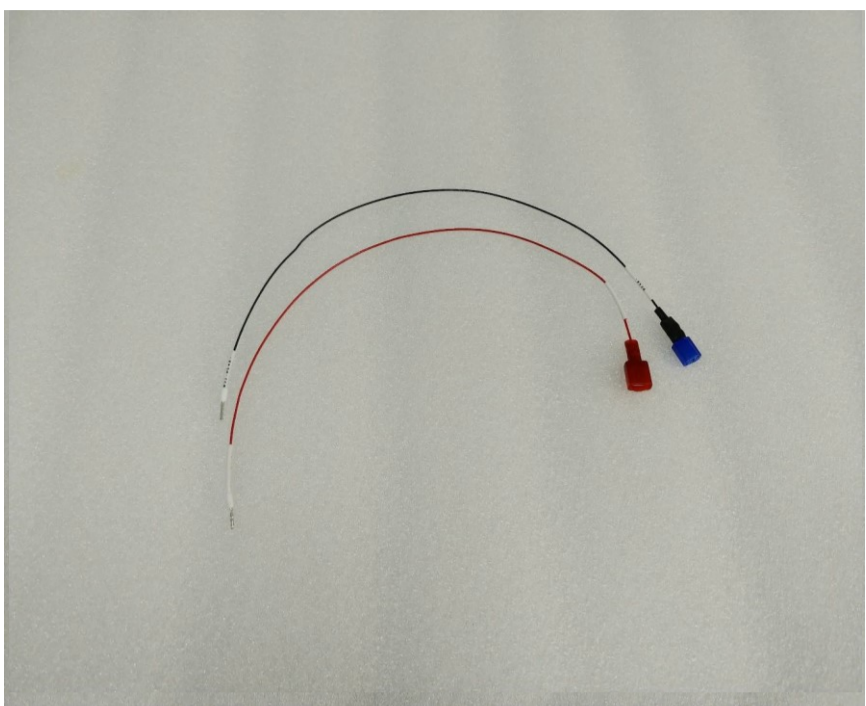

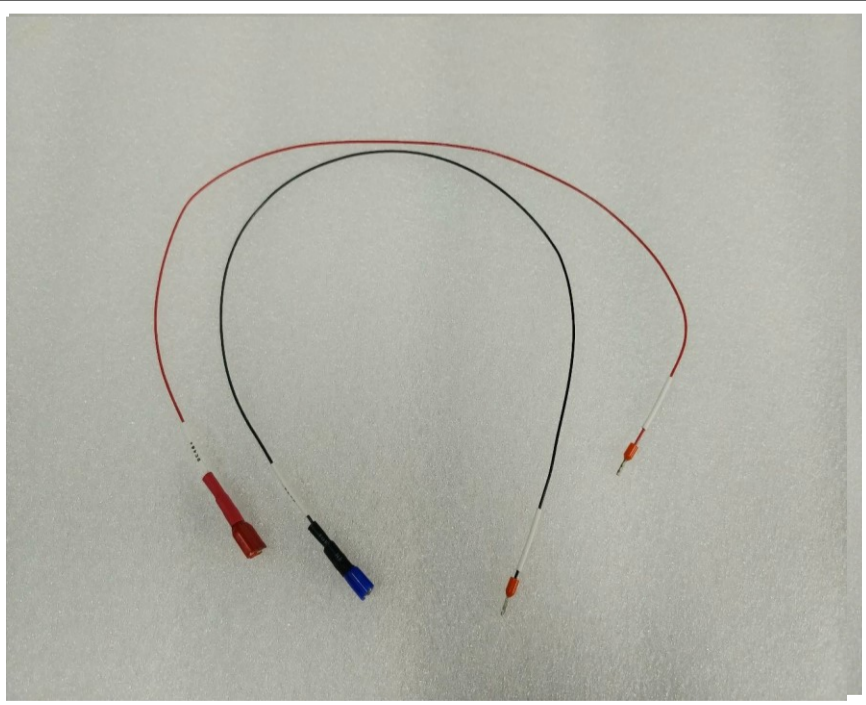
No.	Category(1)	Category(2)	Part Number	Part Name	Picture	Description
15	HCR-3	BODY	AM16-001758A	ASSY,CABLE-HCR03_J2-J3_ET		J2-J3 Communication Cable
16	HCR-3	BODY	AM16-001747A	ASSY,CABLE-HCR03_J2-J3_PWR		J2-J3 Power Cable
17	HCR-3	BODY	AM16-001757A	ASSY,CABLE-HCR03_J3-ARM_ET		J3-Lower Arm Communication Cable

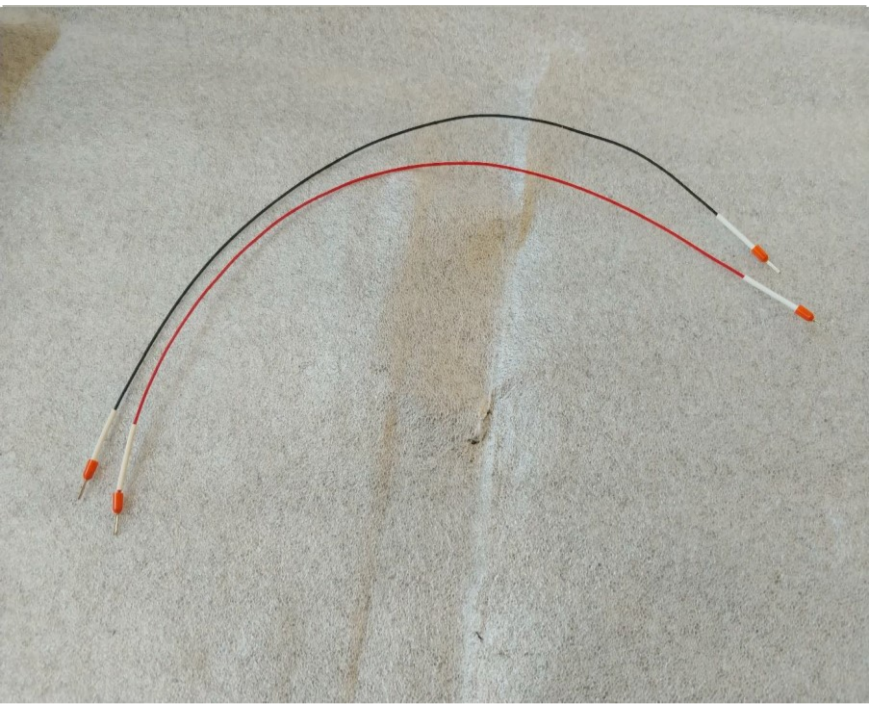
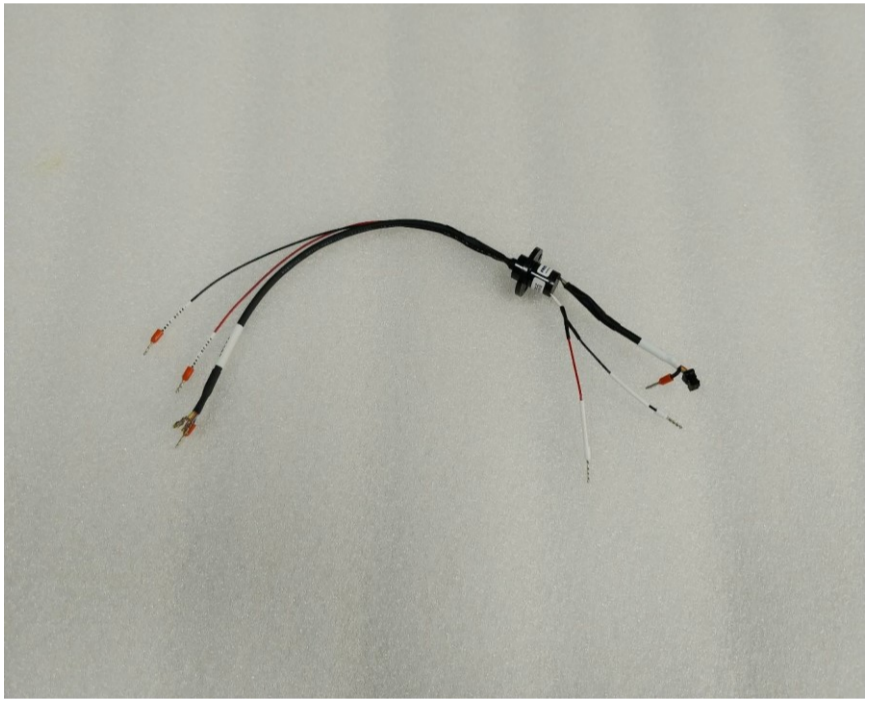
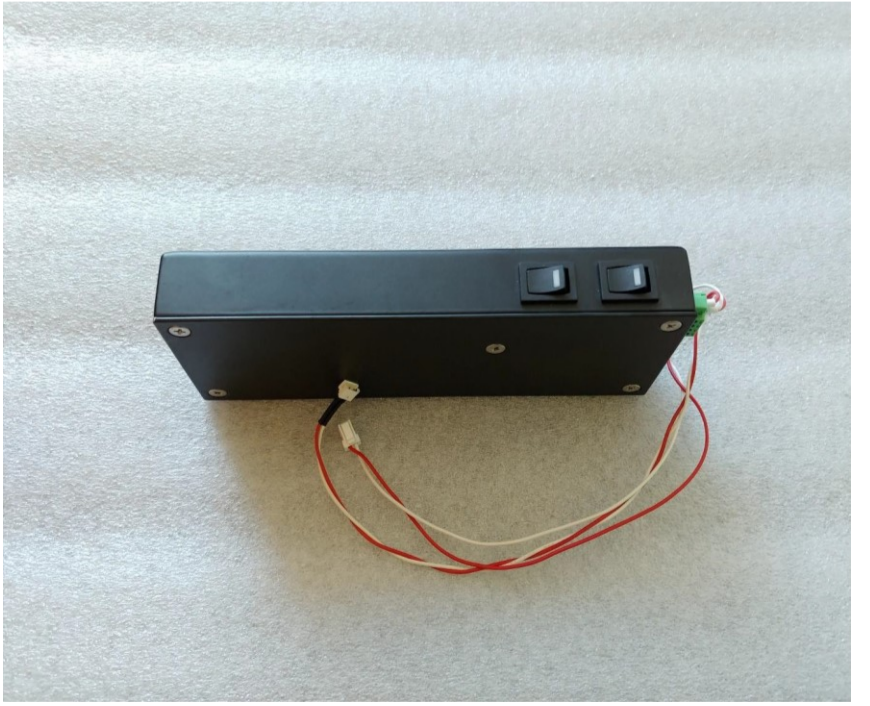

No.	Category(1)	Category(2)	Part Number	Part Name	Picture	Description
18	HCR-3	BODY	AM16-001750A	ASSY,CABLE-HCR03_J3-ARM_PWR		J3-Lower Arm Power Cable
19	HCR-3	BODY	AM16-001759A	ASSY,CABLE-HCR03_ARM-J4_ET		Lower Arm-J4 Communication Cable
20	HCR-3	BODY	AM16-001751A	ASSY,CABLE-HCR03_ARM-J4_PWR		Lower Arm-J4 Power Cable



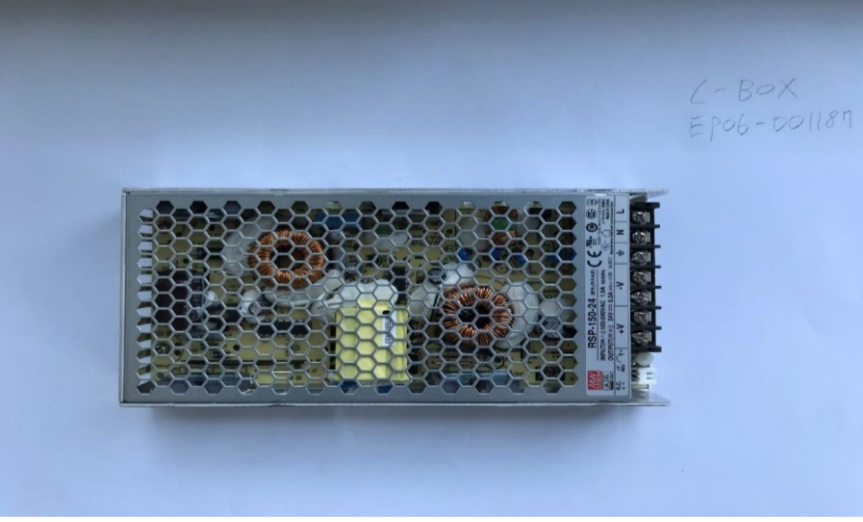

No.	Category(1)	Category(2)	Part Number	Part Name	Picture	Description
21	HCR-3	BODY	AM16-001760A	ASSY,CABLE-HCR03_J4-J5_ET		J4-J5 Communication Cable
22	HCR-3	BODY	AM16-001753A	ASSY,CABLE-HCR03_J4-J5_PWR		J4-J5 Power Cable
23	HCR-3	BODY	AM16-001761A	ASSY,CABLE-HCR03_J5-J6_ET		J5-J6 Communication Cable

No.	Category(1)	Category(2)	Part Number	Part Name	Picture	Description
24	HCR-3	BODY	AM16-001752A	ASSY,CABLE-HCR03_J5-J6_PWR		J5-J6 Power Cable
25	HCR-3	BODY	AM16-001767A	ASSY,CABLE-HCR03_J6-TOOL_SLIPRING		J6-Tool Cable
26	HCR-3	BODY	AM03-026317A	ASSY,ELECTRIC-HCR5-BRK_KIT_ELECTRIC_ASSY		Brake Release Kit

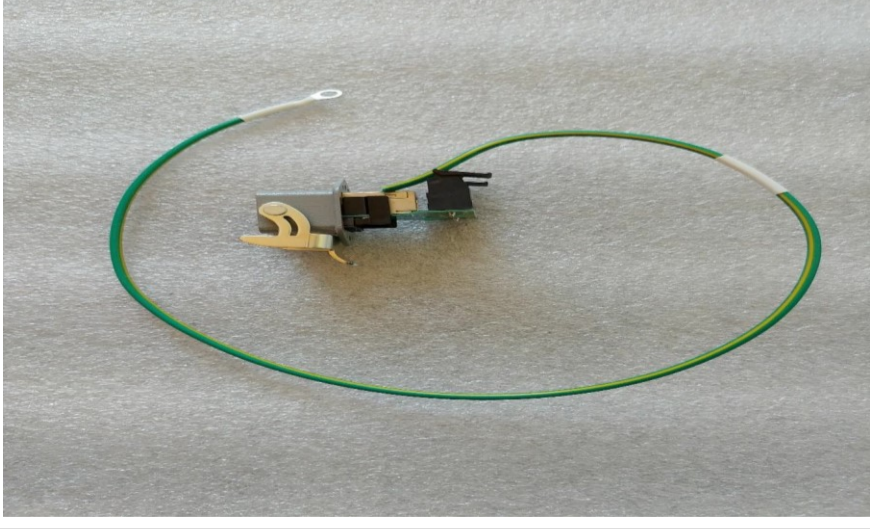

2. HCR-3 Controller

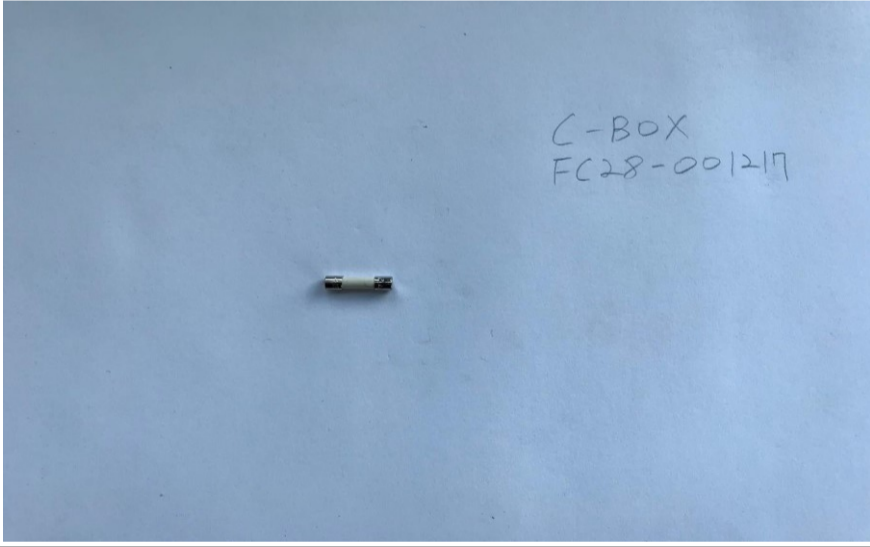
No.	Category(1)	Category(2)	Part Number	Part Name	Picture	Description
1	HCR-3	C-BOX	CD02-001026	INDUSTRIAL EMBEDDED PC_WEBS-2190-E3845		EPC
2	HCR-3	C-BOX	EP06-001186	SUPPLY,POWER,AC-DC- RSP-1000-48;48V,21A,1		48V Power Supply
3	HCR-3	C-BOX	EP06-001187	SUPPLY,POWER,AC-DC- RSP-150-24;24V,6.3A,1		24V Power Supply

No.	Category(1)	Category(2)	Part Number	Part Name	Picture	Description
4	HCR-3	C-BOX	EP07-002449	EMC FILTER		
5	HCR-3	C-BOX	EP06-002974B	BOX,CONTROL-C-BOX FAN ASS'Y FUSE		FAN
6	HCR-3	C-BOX	AM16-001716A	ASS'Y,CABLE-BOX-SURGE FILTER ASS'Y		
7	HCR-3	C-BOX	AM16-001717A	ASSY,CABLE-C-BOX-RJ45 HYBRID ASS'Y		

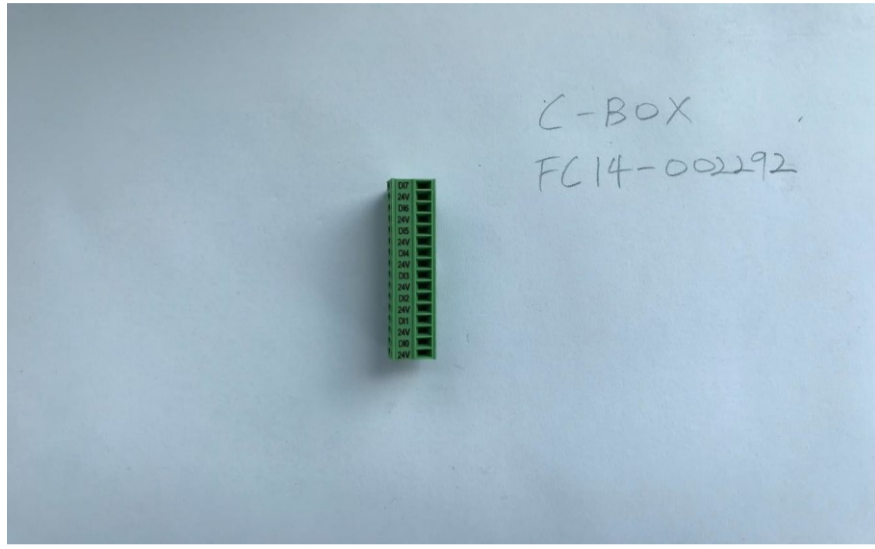
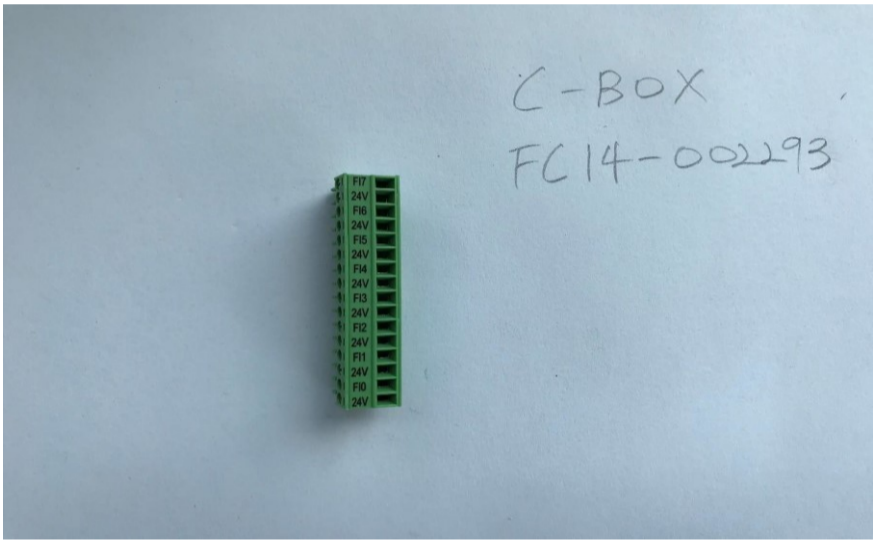
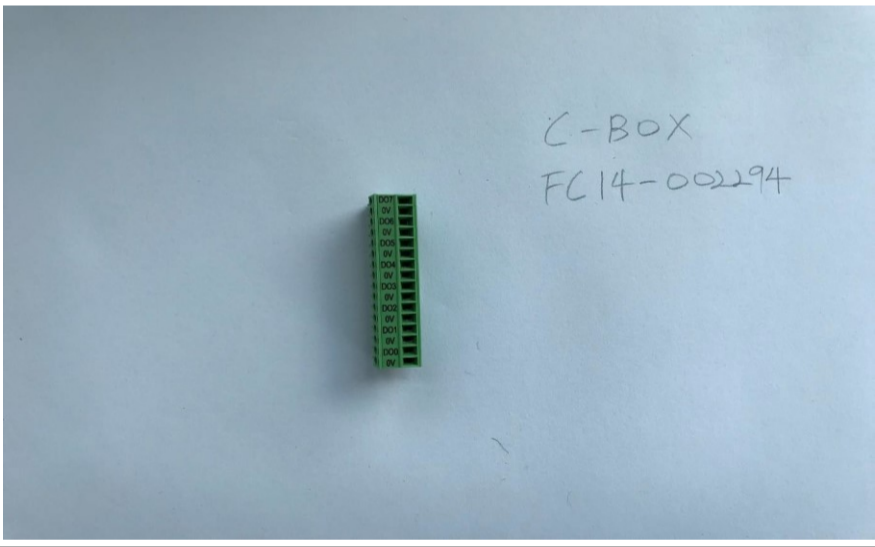
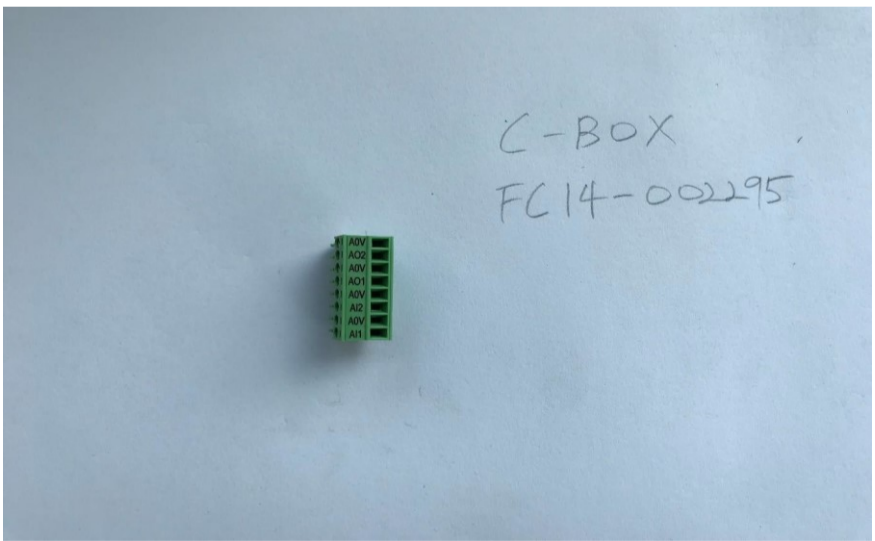

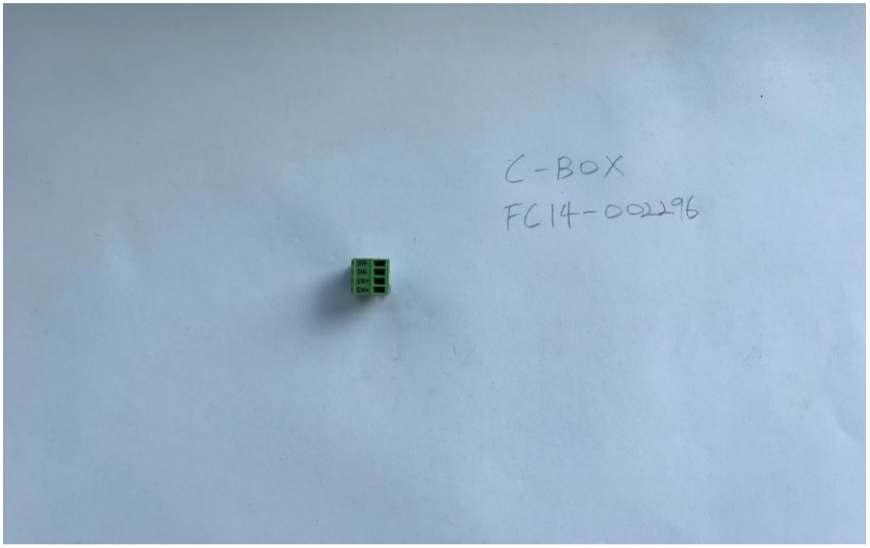
No.	Category(1)	Category(2)	Part Number	Part Name	Picture	Description
8	HCR-3	C-BOX	EP03-00109	ACCESSORY,CABLE-NMC-U7005Z		Ethernet Cable
9	HCR-3	C-BOX	FC28-001216	AC INLET		
10	HCR-3	C-BOX	FC28-001217	AC INLET FUSE		Inlet Fuse
11	HCR-3	C-BOX	EP07-002451	Magnetic Contactor		

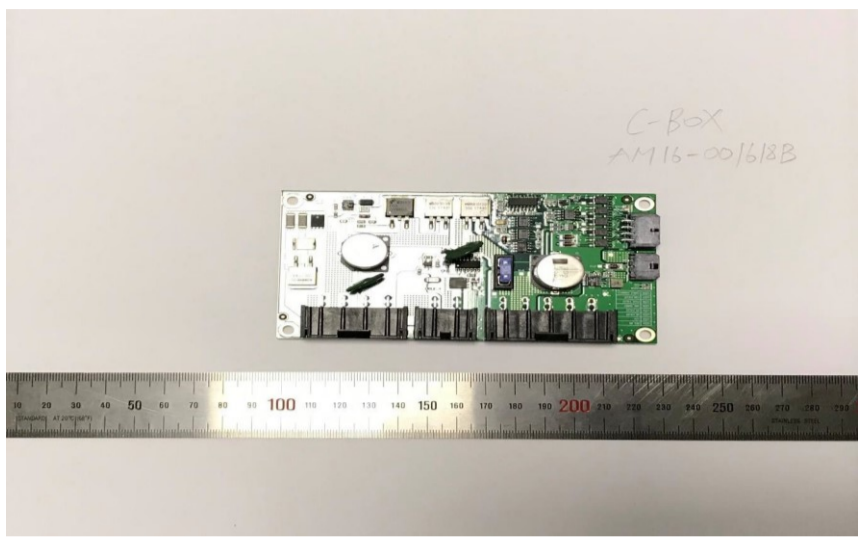
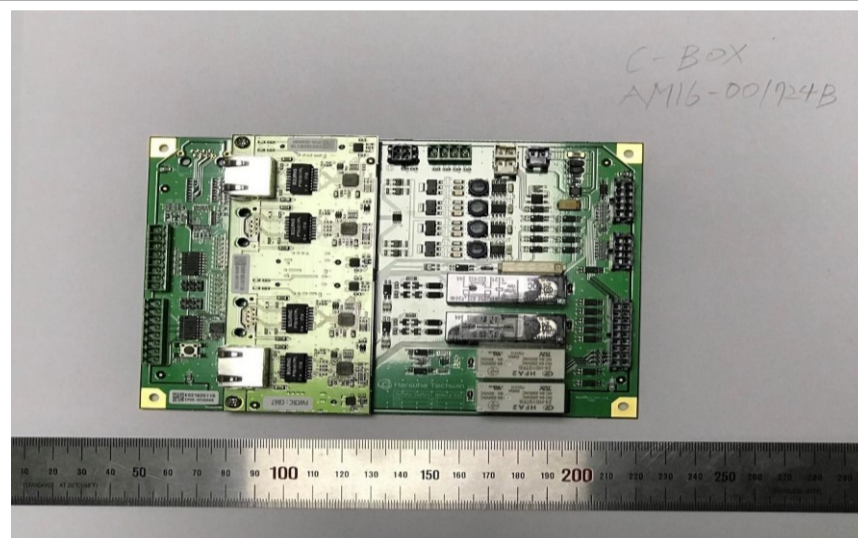
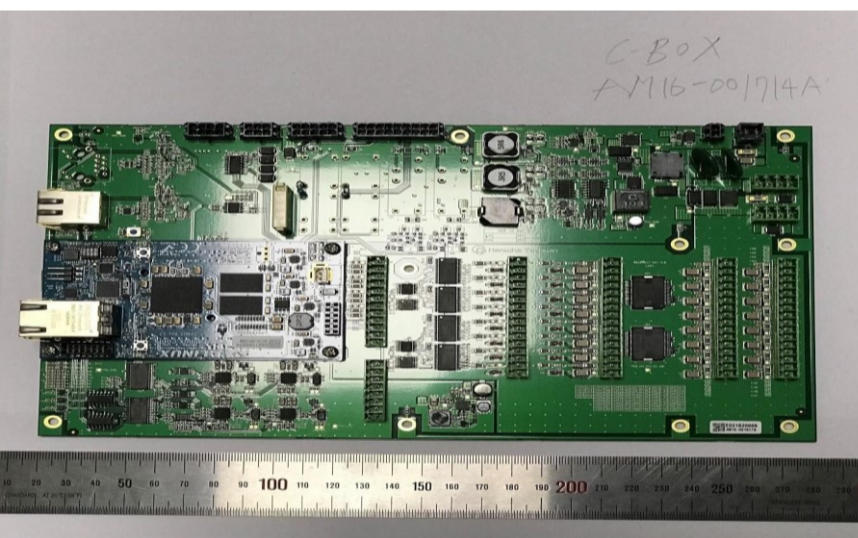

No.	Category(1)	Category(2)	Part Number	Part Name	Picture	Description
12	HCR-3	C-BOX	FC14-002292	IO BOARD_DI_CONNECTOR		Digital Input Connector
13	HCR-3	C-BOX	FC14-002293	IO BOARD_FI_CONNECTOR		Flexible Input Connector
14	HCR-3	C-BOX	FC14-002294	IO BOARD_DO_CONNECTOR		Digital Output Connector
15	HCR-3	C-BOX	FC14-002295	IO BOARD_AIO_CONNECTOR		Analog Input/Output Connector

No.	Category(1)	Category(2)	Part Number	Part Name	Picture	Description
16	HCR-3	C-BOX	FC14-002296	IO BOARD_SW_CONNECTOR	 C-BOX FC14-002296	
17	HCR-3	C-BOX	FC14-002297	IO BOARD_FO_CONNECTOR	 C-BOX FC14-002297	Flexible Output Connector
18	HCR-3	C-BOX	EP10-004039	AC POWER CORD(CHINA)	 EP10-4039	
19	HCR-3	C-BOX	EP10-003939	AC POWER CORD(KOREA)	 C-BOX EP10-003939	

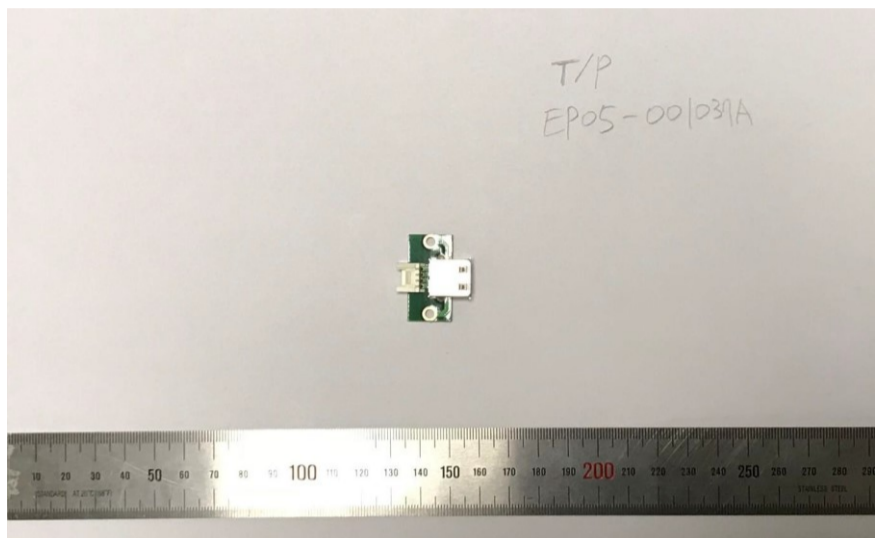
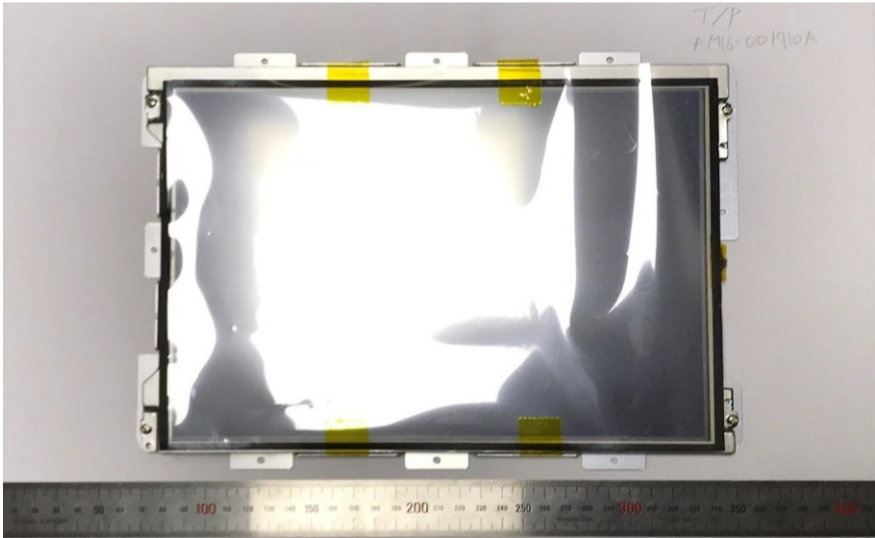
No.	Category(1)	Category(2)	Part Number	Part Name	Picture	Description
20	HCR-3	C-BOX	AM16-001618B	RESISTOR BOARD	 A photograph of a small green printed circuit board (PCB) populated with various electronic components, primarily resistors. The board is shown against a light background with a ruler below it for scale. Handwritten text in the top right corner of the image reads "C-BOX" and "AM16-001618B".	
21	HCR-3	C-BOX	AM16-001724B	SAFETY-BOARD	 A photograph of a larger green PCB populated with numerous electronic components, including integrated circuits, capacitors, and connectors. A ruler is placed below the board for scale. Handwritten text in the top right corner of the image reads "C-BOX" and "AM16-001724B".	
22	HCR-3	C-BOX	AM16-002038A	ASS'Y,BOARD-HC-P_CONTROL	 A photograph of a large green PCB populated with a complex array of electronic components, including multiple integrated circuits, capacitors, and connectors. A ruler is placed below the board for scale. Handwritten text in the top right corner of the image reads "C-BOX" and "AM16-001714A".	

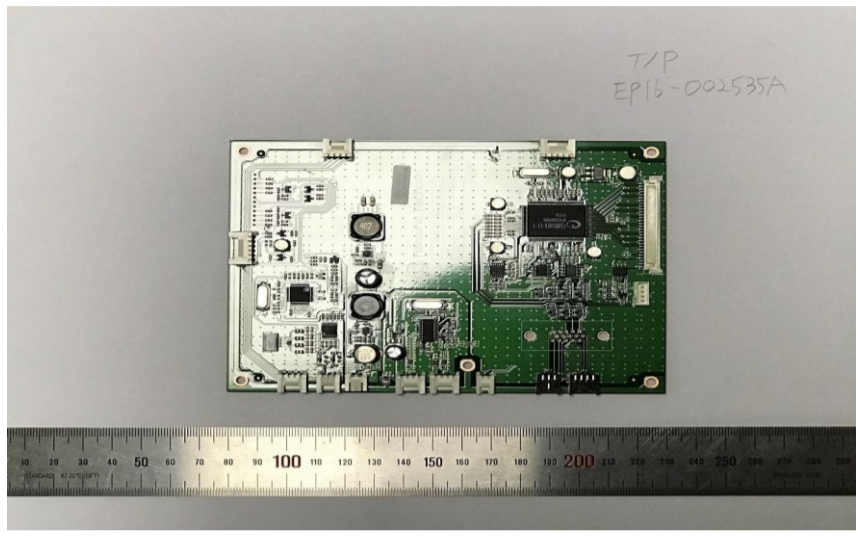
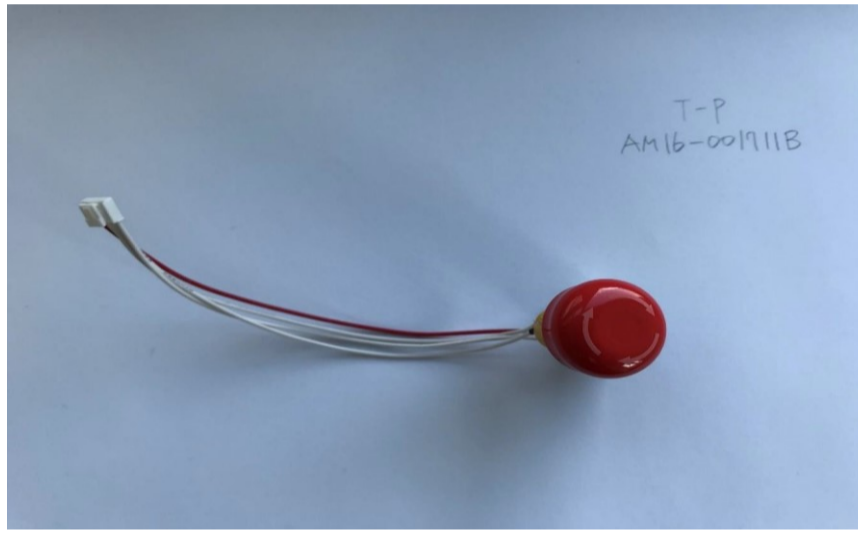

3. HCR-3 TP



No.	Category(1)	Category(2)	Item	Item Name	Picture	Description
1	HCR-3	TP	EP05-001037A	ADAPTOR,CONNECTOR-USB		USB Connector
2	HCR-3	TP	AM16-001710A	ASSY,COVER-HCR TP LCD PANNEL		LCD
3	HCR-3	TP	EP20-001039A	SWITCH,PUSH-HCR TP STANDBY ASSY		Power Switch

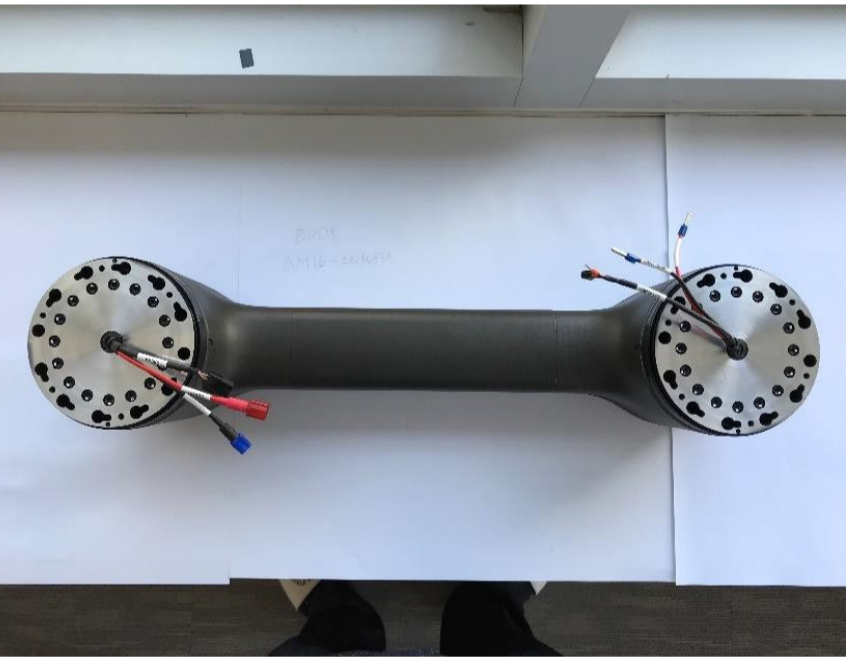

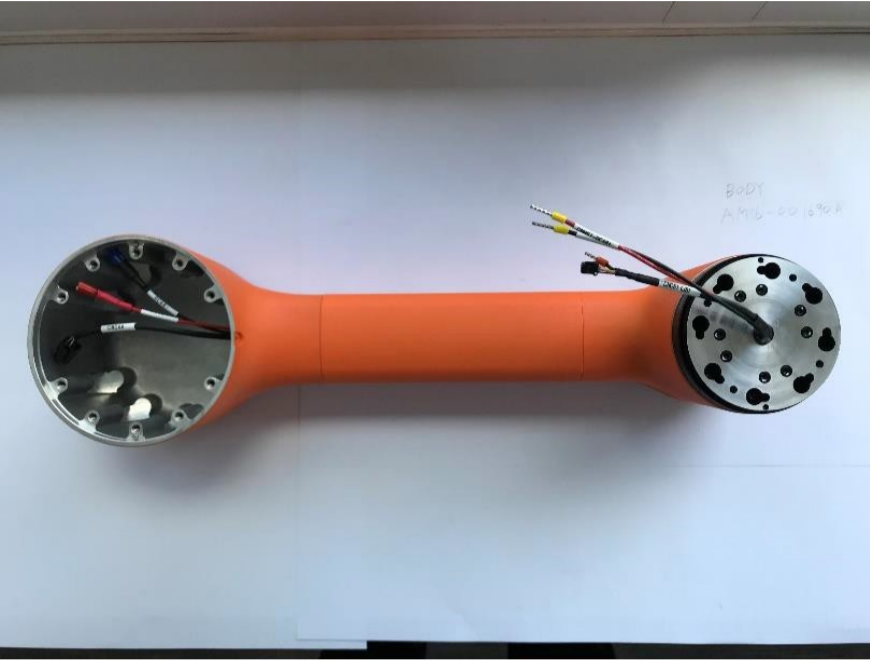
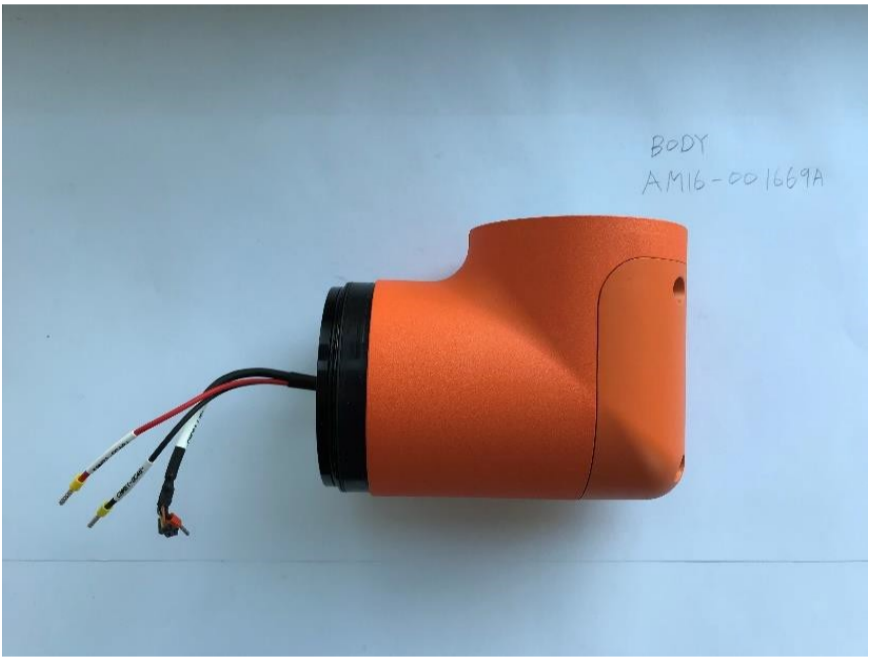
No.	Category(1)	Category(2)	Item	Item Name	Picture	Description
4	HCR-3	TP	EP16-002535A	PCB,LCD-HCR TP AD BOARD		
5	HCR-3	TP	AM16-001711B	ASSY,BOARD-HCR TP EMO SWITCH_B		Emergency Switch
6	HCR-3	TP	AM16-001713A	ASSY,CABLE-HCR TP MAIN CABLE		Main Cable

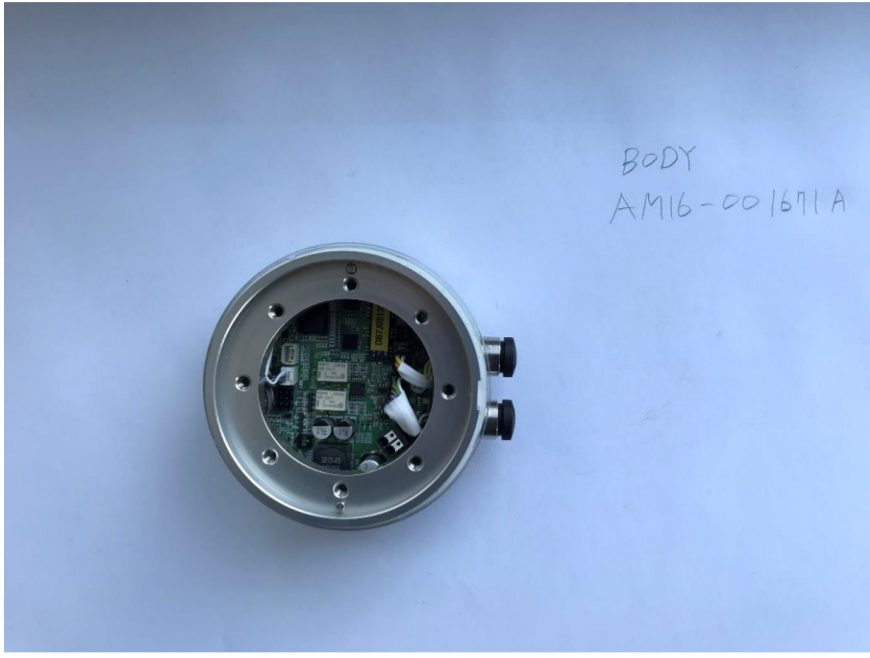

4. HCR-5 BODY

No.	Category(1)	Category(2)	Part Number	Part Name	Picture	Description
1	HCR-5	BODY	AM16-001668A	HCR05-S0-100-J1_ASSY		JOINT 1 ASS'Y
2	HCR-5	BODY	AM16-001683A	HCR05-S0-300-UPPER ARM ASSY		JOINT 2 and JOINT 3 ASS'Y (It can't be seperated)

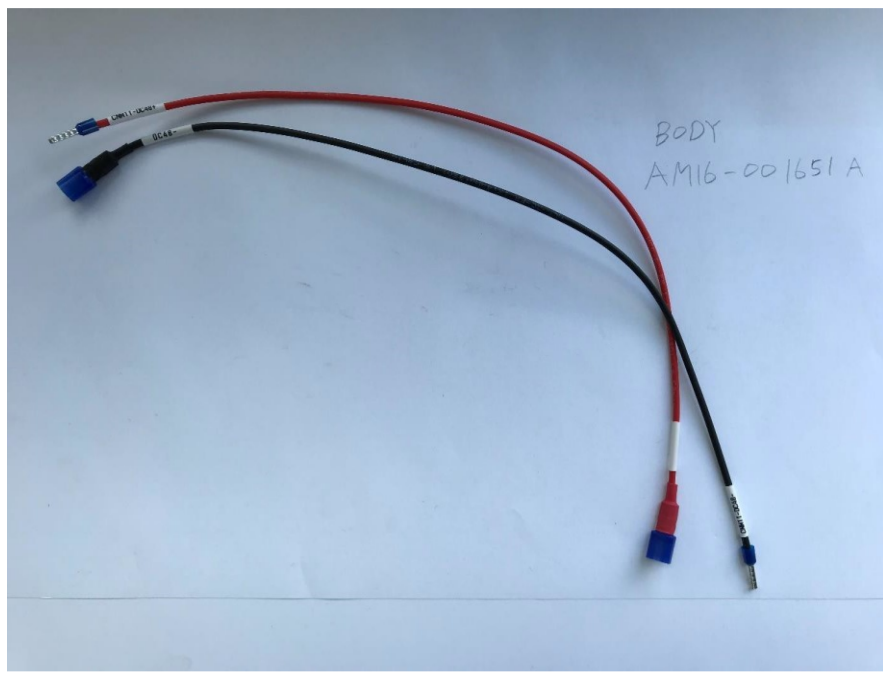
No.	Category(1)	Category(2)	Part Number	Part Name	Picture	Description
3	HCR-5	BODY	AM16-001690A	HCR05-S0-400-LOWER_ARM_ASSY		JOINT 4 ASS'Y
4	HCR-5	BODY	AM16-001669A	HCR05-S0-500_J5_ASSY		JOINT 5 ASS'Y
5	HCR-5	BODY	AM16-001679A	HCR05-S0-600-J6_ASSY		JOINT 6 ASS'Y

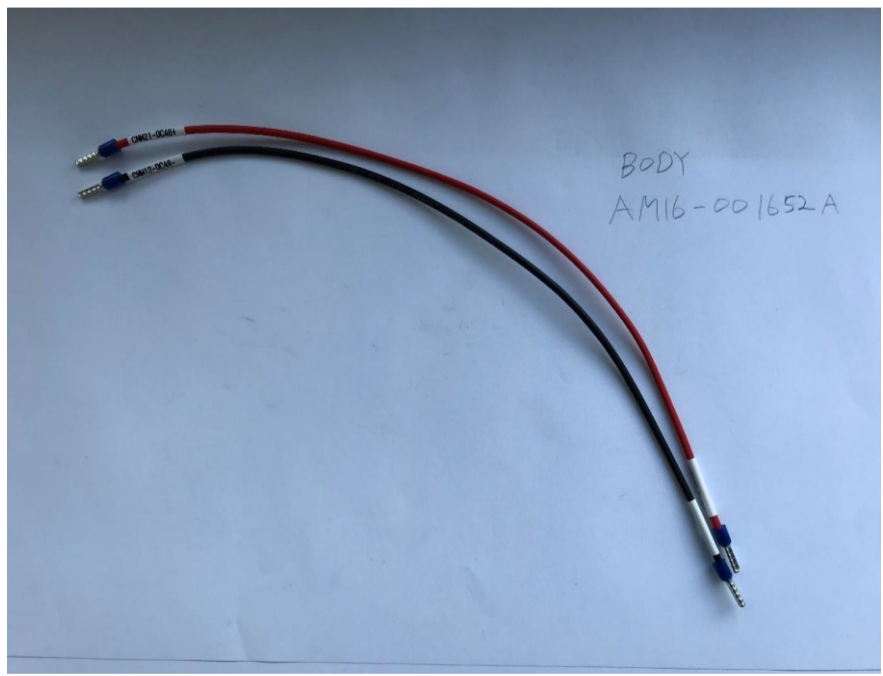

No.	Category(1)	Category(2)	Part Number	Part Name	Picture	Description
6	HCR-5	BODY	AM16-001671A	HCR05-S0-700-TOOL_IO_ASSY		TOOL Flange ASS'Y
7	HCR-5	BODY	AM16-001645A	HCR05-M01-A-MAIN_PWR_ETHERCAT		BASE and Cable ASS'Y (It can't be seperated)
8	HCR-5	BODY	AM16-001649B	HCR05-C01-A_BASE-J1_ETHERCAT		Base-J1 Communication Cable

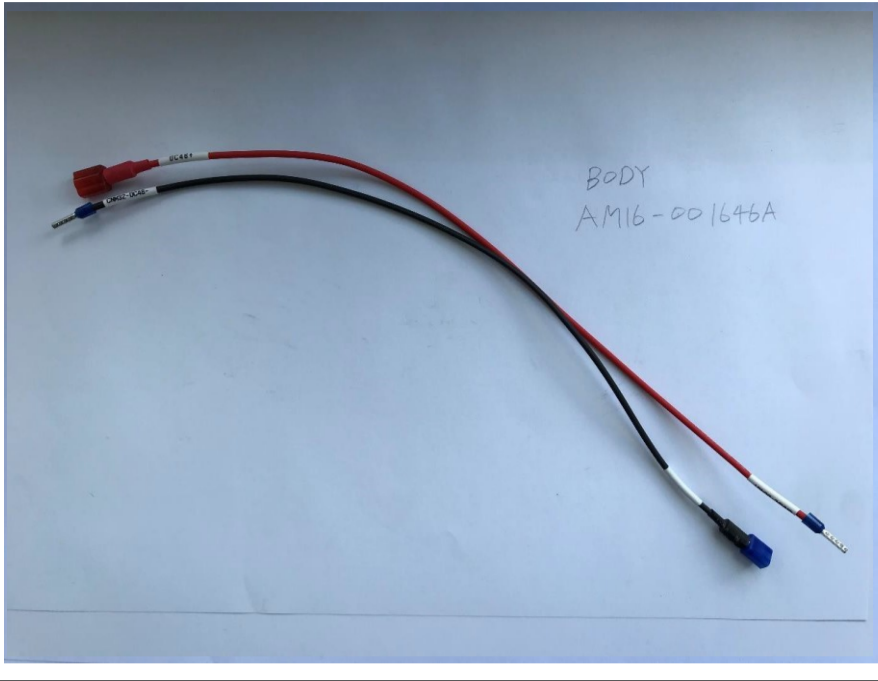
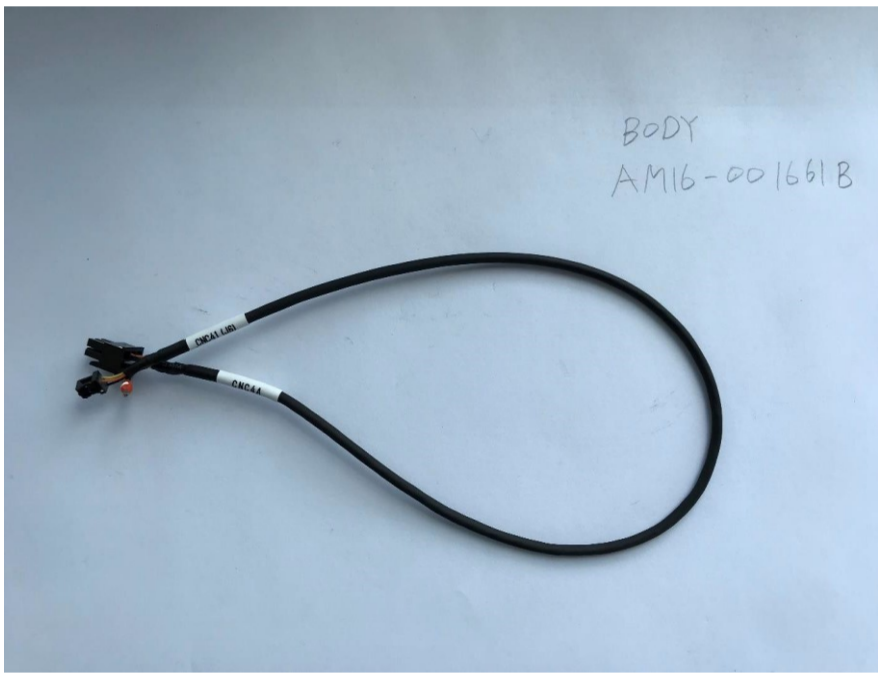
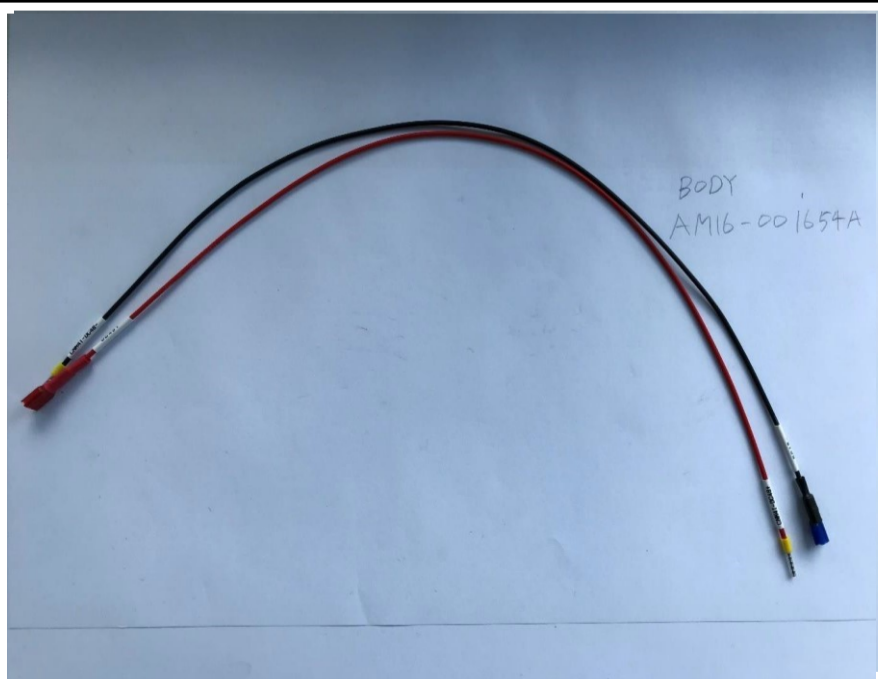

No.	Category(1)	Category(2)	Part Number	Part Name	Picture	Description
9	HCR-5	BODY	AM16-001651A	HCR05-M02-A_BASE-J1_PWR		Base-J1 Power Cable
10	HCR-5	BODY	AM16-001664B	HCR05-C02-A_BASE-J1-J2_ETHERCAT		J1-J2 Communication Cable
11	HCR-5	BODY	AM16-001652A	HCR05-M03-A_J1-J2_PWR		J1-J2 Power Cable

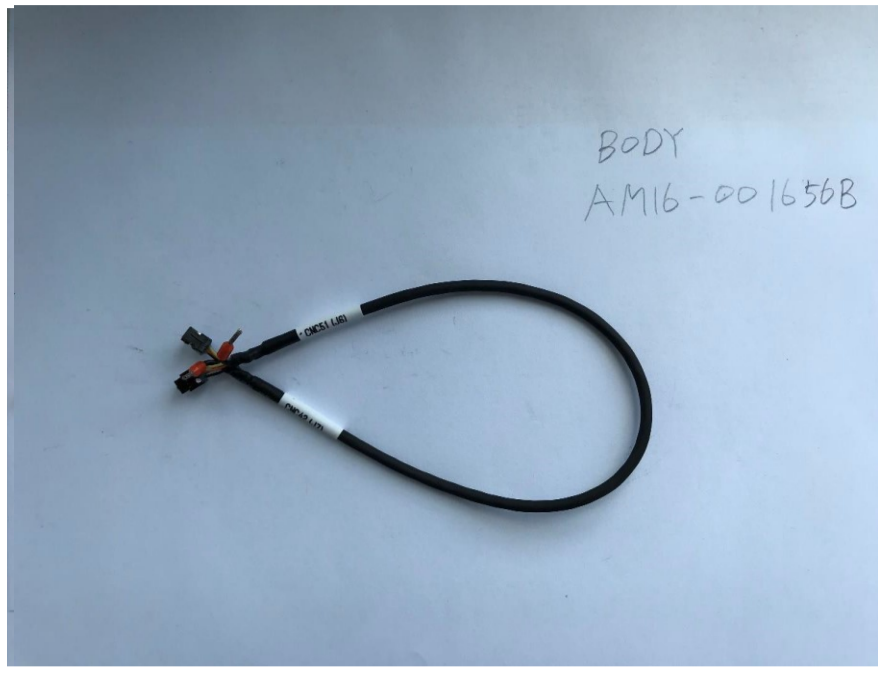
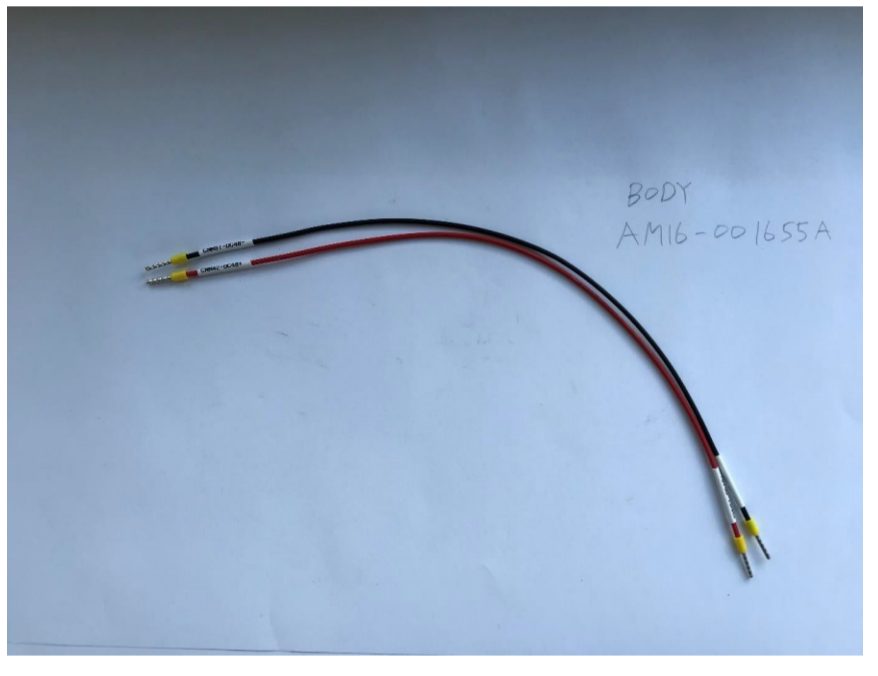
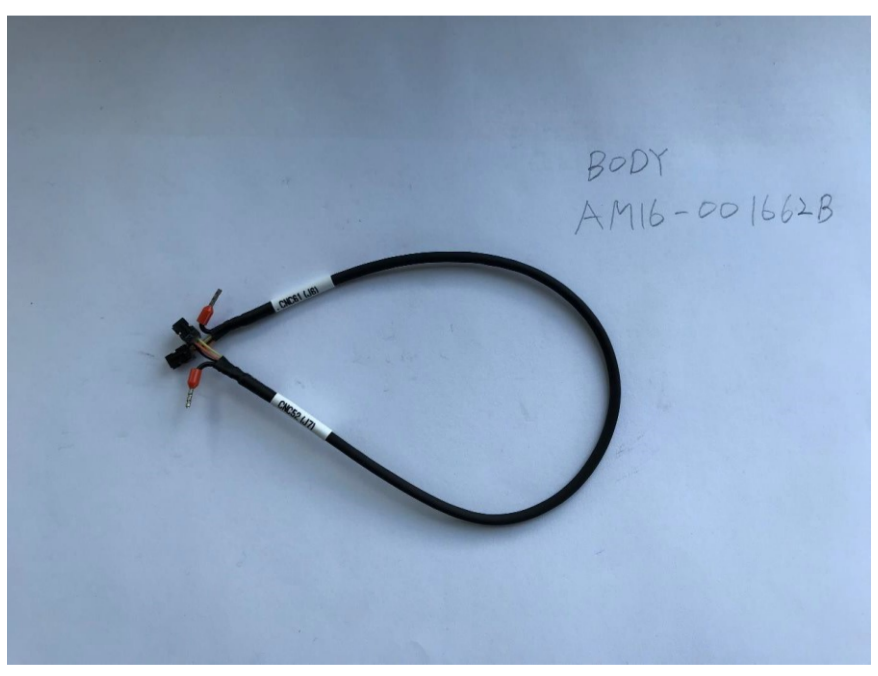
No.	Category(1)	Category(2)	Part Number	Part Name	Picture	Description
12	HCR-5	BODY	AM16-001665B	HCR05-C02-B_J2-J3_ETHERCAT		J2-J3 Communication Cable
14	HCR-5	BODY	AM16-001653A	HCR05-M03-B_J2-J3_PWR		J2-J3 Power Cable
15	HCR-5	BODY	AM16-001658B	HCR05-C03-A_J3-ARM_ETHERCAT		J3-Lower Arm Communication Cable

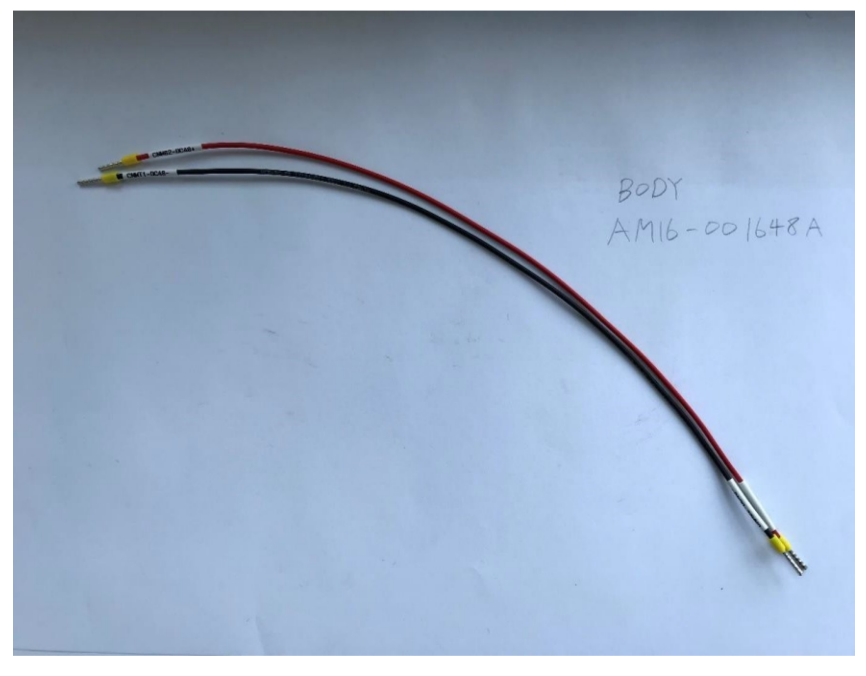

No.	Category(1)	Category(2)	Part Number	Part Name	Picture	Description
16	HCR-5	BODY	AM16-001646A	HCR05-M04-A_J3-ARM_PWR		J3-Lower Arm Power Cable
17	HCR-5	BODY	AM16-001661B	HCR05-C01-B_ARM-J4_ETHERCAT		Lower Arm-J4 Communication Cable
18	HCR-5	BODY	AM16-001654A	HCR05-M05-A_ARM-J4_PWR		Lower Arm-J4 Power Cable



No.	Category(1)	Category(2)	Part Number	Part Name	Picture	Description
19	HCR-5	BODY	AM16-001656B	HCR05-C02-C_J4-J5_ETHERCAT		J4-J5 Communication Cable
20	HCR-5	BODY	AM16-001655A	HCR05-M06-A_J4-J5_PWR		J4-J5 Power Cable
21	HCR-5	BODY	AM16-001662B	HCR05-C02-D_J5-J6_ETHERCAT		J5-J6 Communication Cable



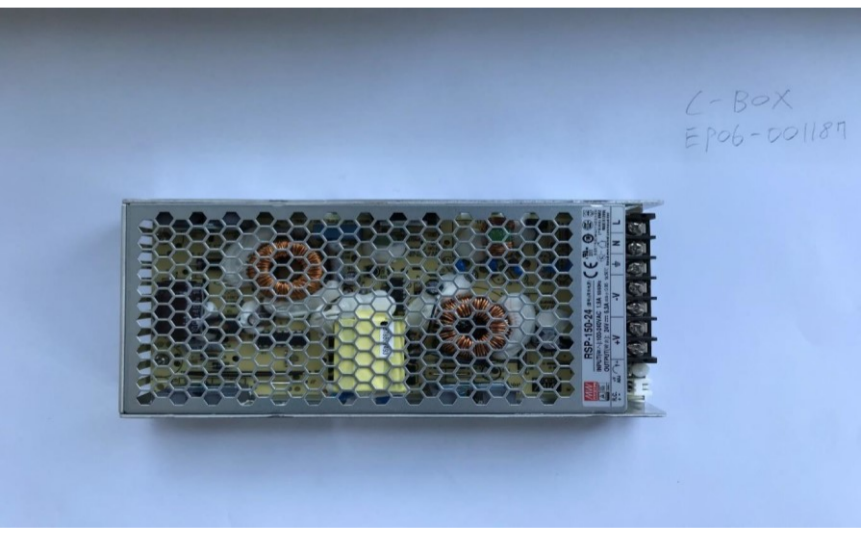

No.	Category(1)	Category(2)	Part Number	Part Name	Picture	Description
22	HCR-5	BODY	AM16-001647A	HCR05-M06-B_J5-J6_PWR		J5-J6 Power Cable
23	HCR-5	BODY	AM16-001657B	HCR05-C02-E_J6-TOOLIO_ETHERCAT		J6-Tool Communication Cable
24	HCR-5	BODY	AM16-001648A	HCR05-M06-C_J6-TOOL_IO_PWR		J6-Tool Power Cable

No.	Category(1)	Category(2)	Part Number	Part Name	Picture	Description
25	HCR-5	BODY	EP05-002300	BUNDLE TOOL IO 12pin CABLE		
26	HCR-5	BODY	EP05-002315	BUNDLE TOOL IO 4pin CABLE		
27	HCR-5	BODY	AM03-026317A	ASSY,ELECTRIC-HCR5- BRK_KIT_ELECTRIC_ASSY		Brake Release Kit

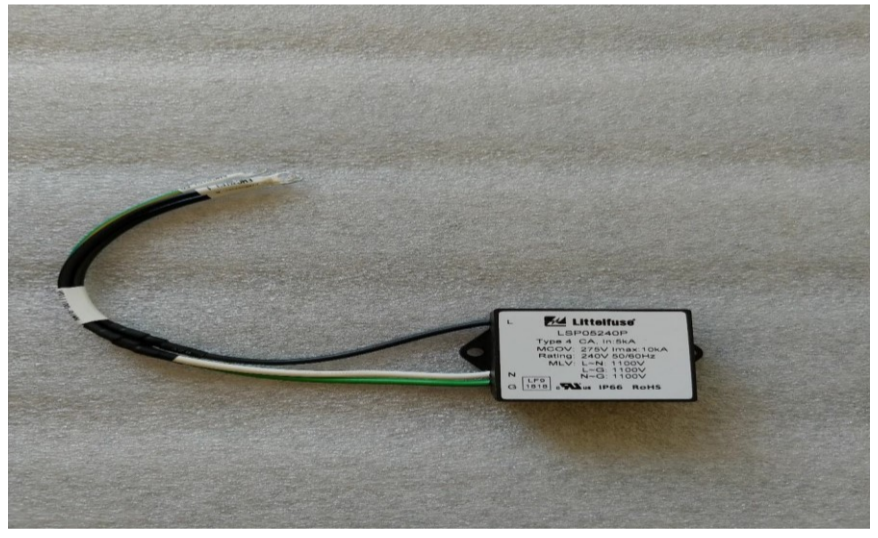
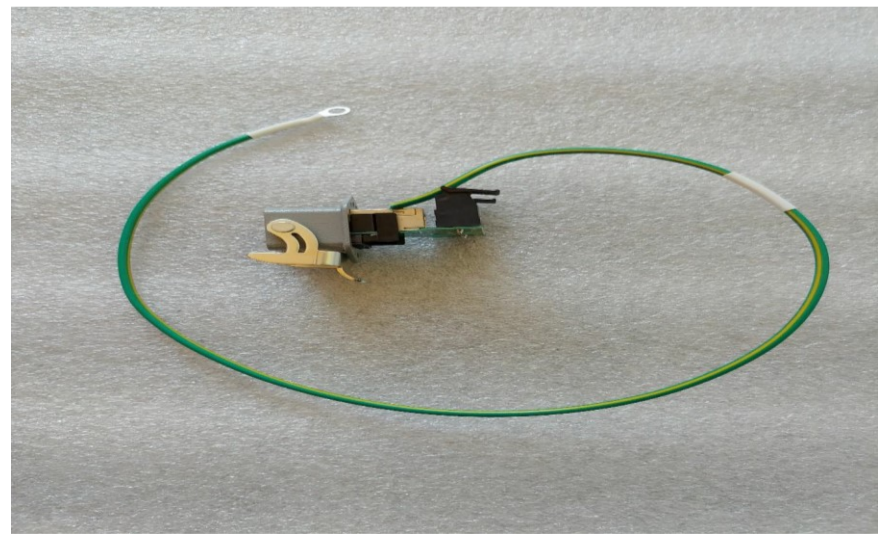

5. HCR-5 Controller

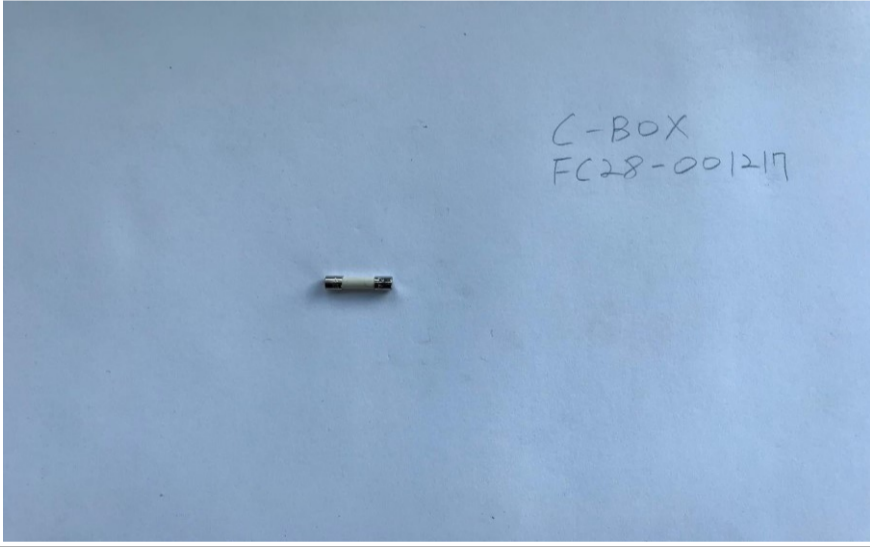
No.	Category(1)	Category(2)	Part Number	Part Name	Picture	Description
1	HCR-5	C-BOX	CD02-001026	INDUSTRIAL EMBEDDED PC_WEBS-2190-E3845		EPC
2	HCR-5	C-BOX	EP06-001186	SUPPLY,POWER,AC-DC- RSP-1000-48;48V,21A,1		48V Power Supply
3	HCR-5	C-BOX	EP06-001187	SUPPLY,POWER,AC-DC- RSP-150-24;24V,6.3A,1		24V Power Supply

No.	Category(1)	Category(2)	Part Number	Part Name	Picture	Description
4	HCR-5	C-BOX	EP07-002449	EMC FILTER		
5	HCR-5	C-BOX	EP06-002974B	BOX,CONTROL-C-BOX FAN ASS'Y FUSE		FAN
6	HCR-5	C-BOX	AM16-001716A	ASS'Y,CABLE-BOX-SURGE FILTER ASS'Y		
7	HCR-5	C-BOX	AM16-001717A	ASSY,CABLE-C-BOX-RJ45 HYBRID ASS'Y		

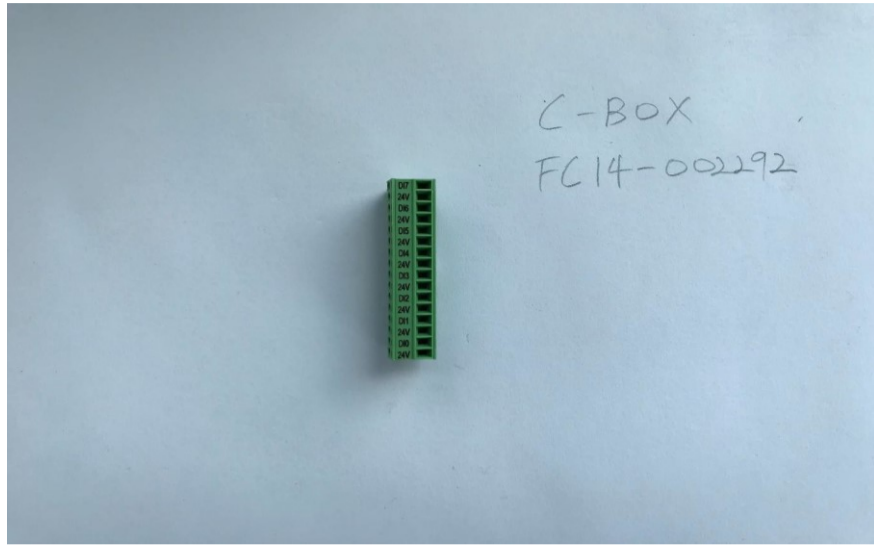
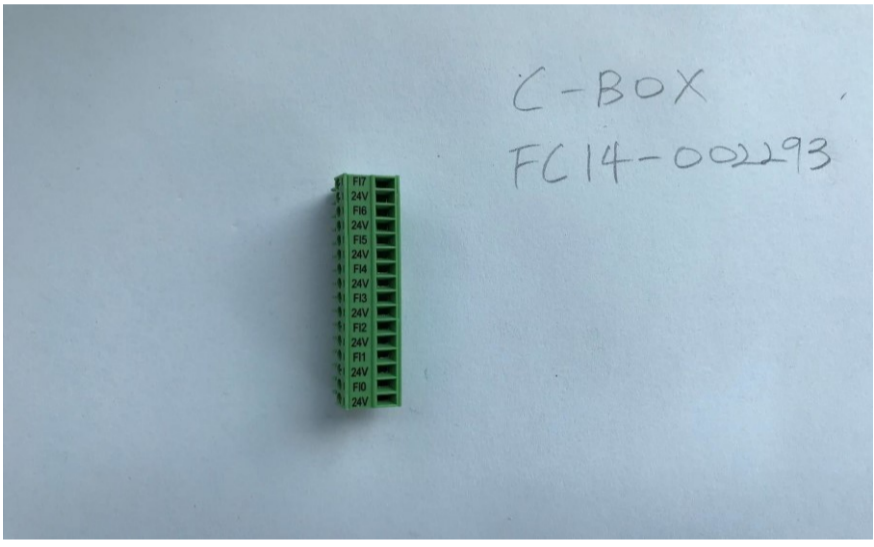
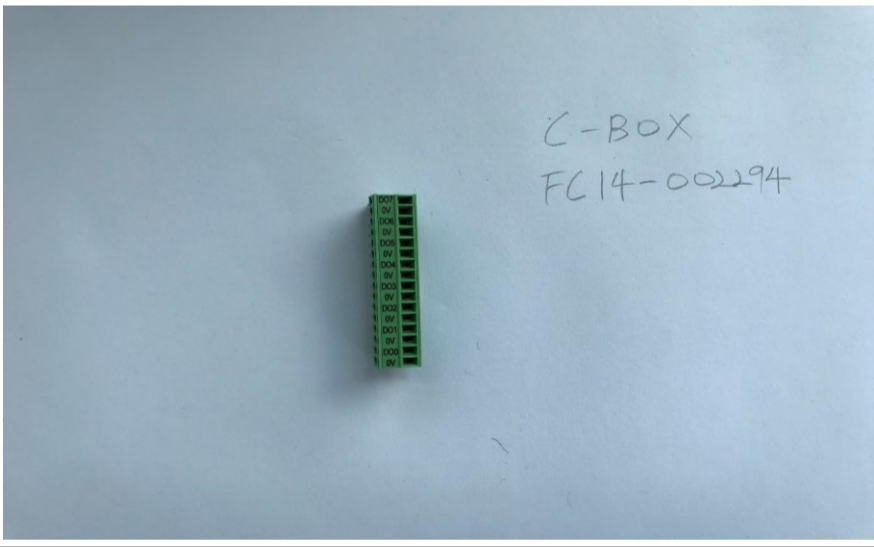
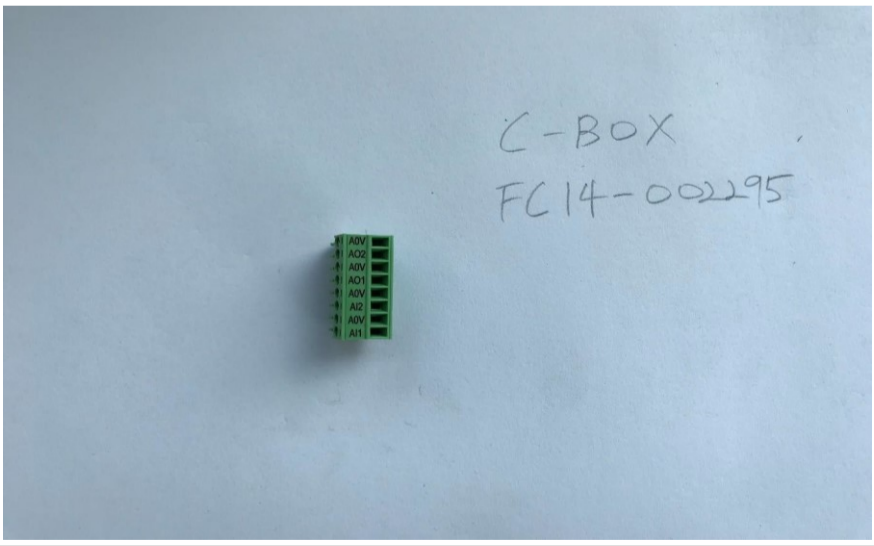

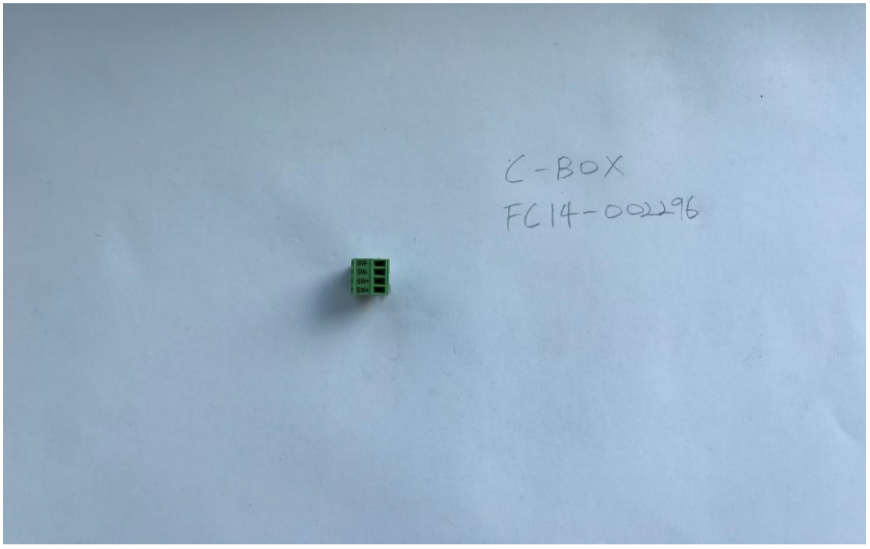
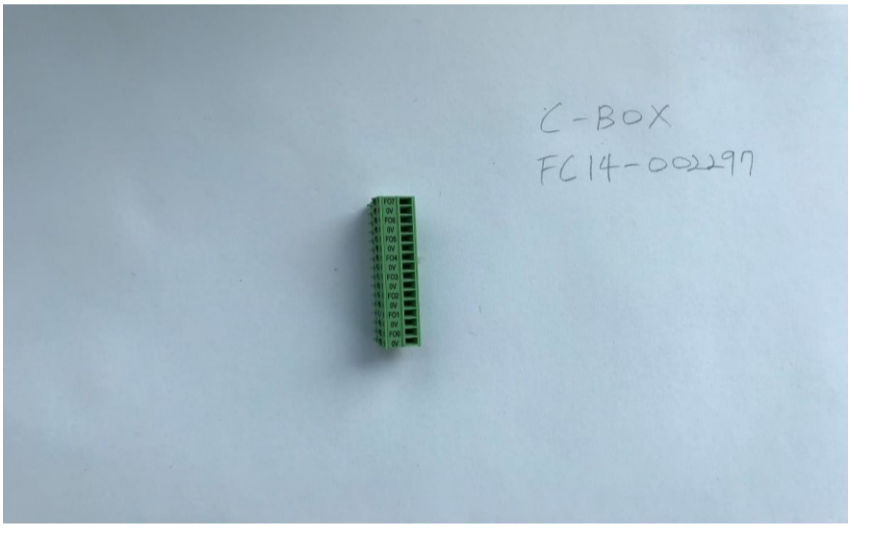
No.	Category(1)	Category(2)	Part Number	Part Name	Picture	Description
8	HCR-5	C-BOX	EP03-00109	ACCESSORY,CABLE-NMC-U7005Z		Ethernet Cable
9	HCR-5	C-BOX	FC28-001216	AC INLET		
10	HCR-5	C-BOX	FC28-001217	AC INLET FUSE		Inlet Fuse
11	HCR-5	C-BOX	EP07-002451	Magnetic Contactor		

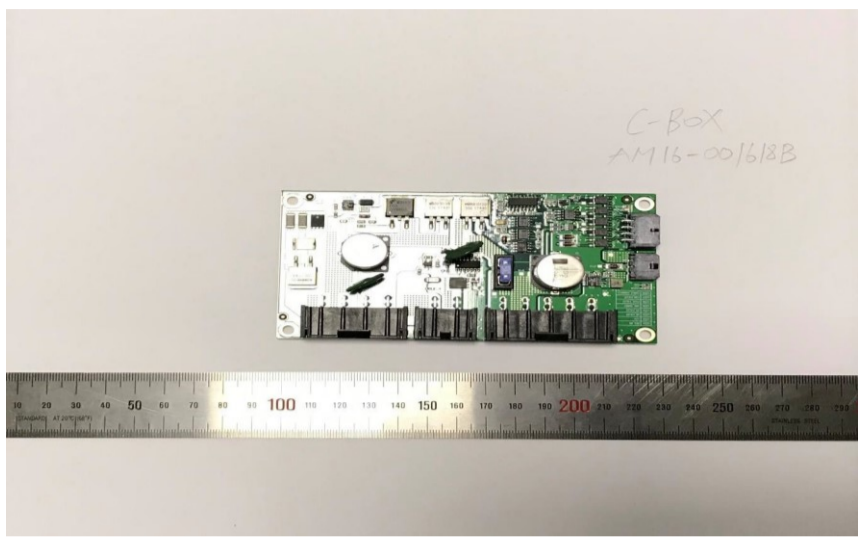
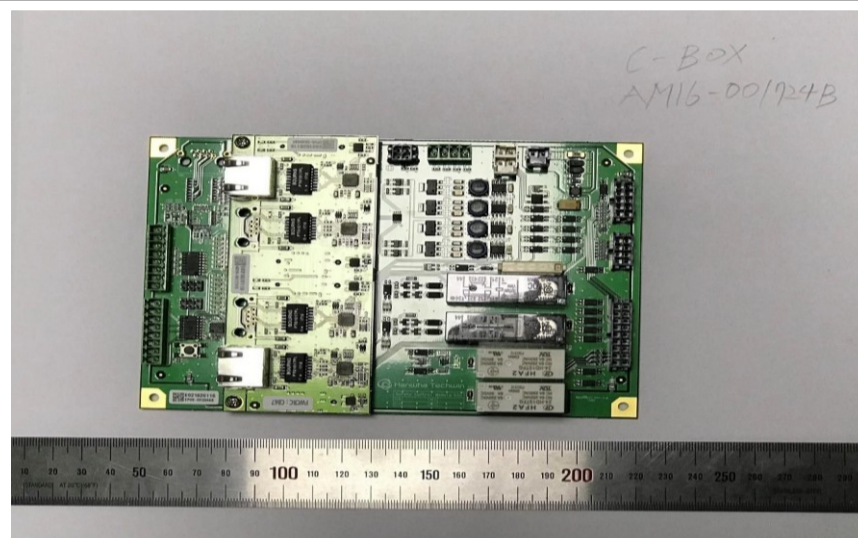
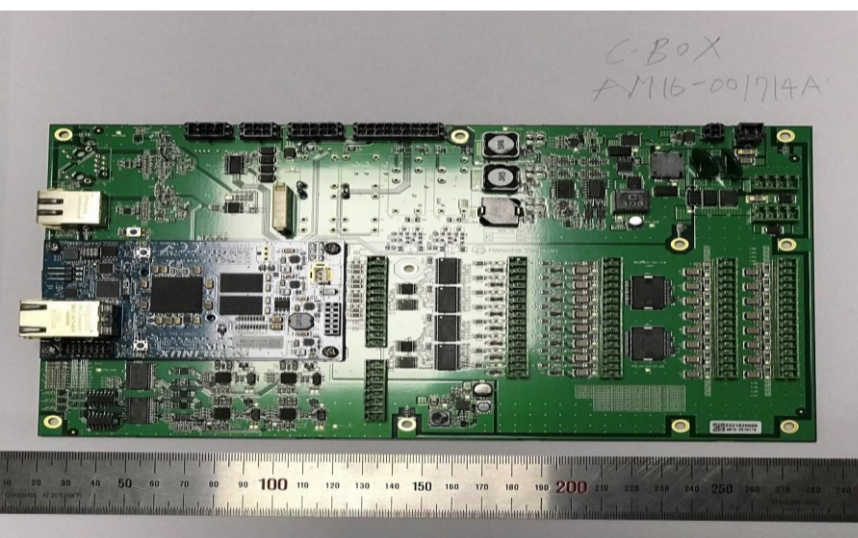

No.	Category(1)	Category(2)	Part Number	Part Name	Picture	Description
12	HCR-5	C-BOX	FC14-002292	IO BOARD_DI_CONNECTOR		Digital Input Connector
13	HCR-5	C-BOX	FC14-002293	IO BOARD_FI_CONNECTOR		Flexible Input Connector
14	HCR-5	C-BOX	FC14-002294	IO BOARD_DO_CONNECTOR		Digital Output Connector
15	HCR-5	C-BOX	FC14-002295	IO BOARD_AIO_CONNECTOR		Analog Input/Output Connector

No.	Category(1)	Category(2)	Part Number	Part Name	Picture	Description
16	HCR-5	C-BOX	FC14-002296	IO BOARD_SW_CONNECTOR	 C-BOX FC14-002296	
17	HCR-5	C-BOX	FC14-002297	IO BOARD_FO_CONNECTOR	 C-BOX FC14-002297	Flexible Output Connector
18	HCR-5	C-BOX	EP10-004039	AC POWER CORD(CHINA)	 EP10-4039	
19	HCR-5	C-BOX	EP10-003939	AC POWER CORD(KOREA)	 C-BOX EP10-003939	

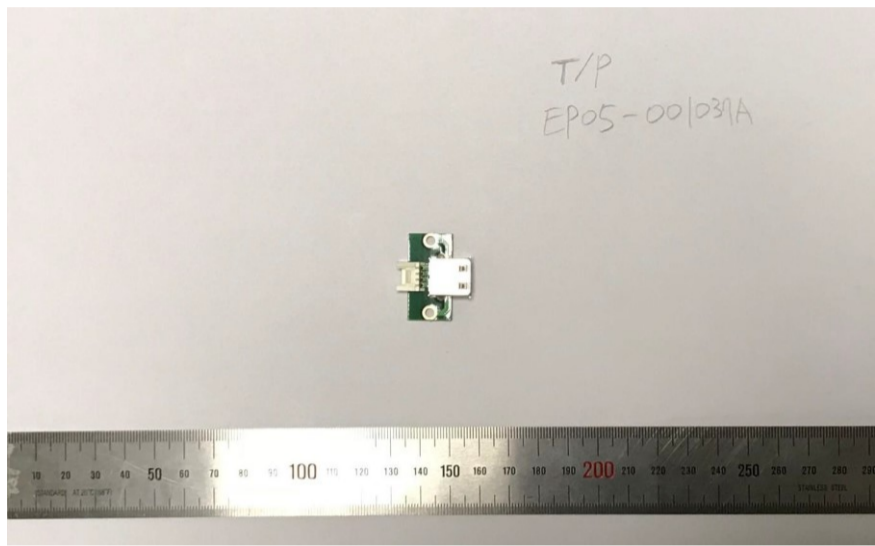
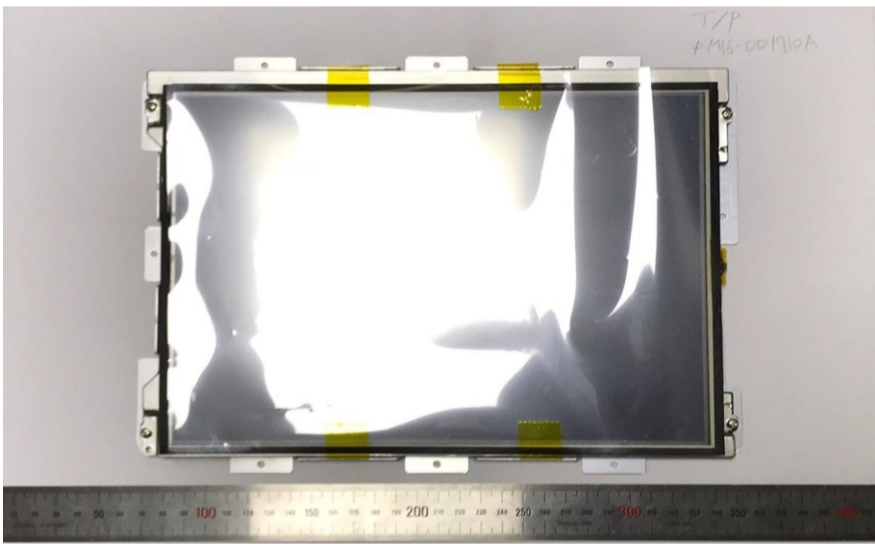
No.	Category(1)	Category(2)	Part Number	Part Name	Picture	Description
20	HCR-5	C-BOX	AM16-001618B	RESISTOR BOARD	 A photograph of a small green printed circuit board (PCB) populated with various electronic components, primarily resistors. The board is rectangular and has several pins along one edge. A ruler is placed below the board for scale. Handwritten text in the top right corner of the image reads "C-BOX" and "AM16-001618B".	
21	HCR-5	C-BOX	AM16-001724B	SAFETY-BOARD	 A photograph of a larger green PCB with a complex layout of components, including integrated circuits, capacitors, and connectors. The board is rectangular and has several pins along one edge. A ruler is placed below the board for scale. Handwritten text in the top right corner of the image reads "C-BOX" and "AM16-001724B".	
22	HCR-5	C-BOX	AM16-002038A	ASS'Y,BOARD-HC-P_CONTROL	 A photograph of a large green PCB with a very dense arrangement of components, including multiple integrated circuits, capacitors, and connectors. The board is rectangular and has several pins along one edge. A ruler is placed below the board for scale. Handwritten text in the top right corner of the image reads "C-BOX" and "AM16-001714A".	

6. HCR-5 TP

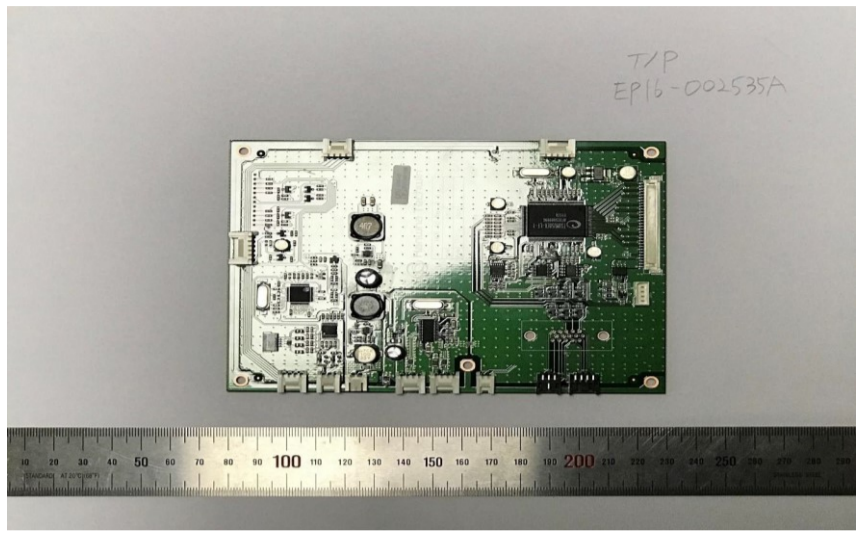
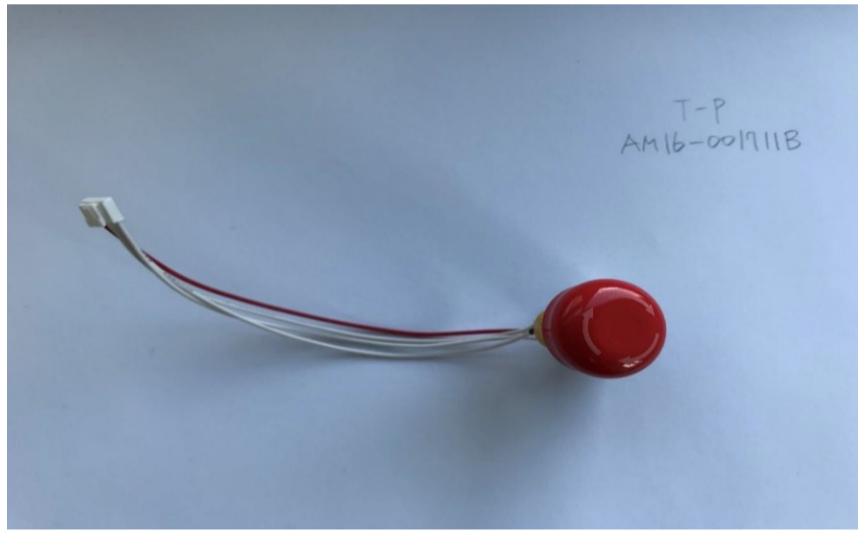

No.	Category(1)	Category(2)	Item	Item Name	Picture	Description
1	HCR-5	TP	EP05-001037A	ADAPTOR,CONNECTOR-USB		USB Connector
2	HCR-5	TP	AM16-001710A	ASSY,COVER-HCR TP LCD PANNEL		LCD
3	HCR-5	TP	EP20-001039A	SWITCH,PUSH-HCR TP STANDBY ASSY		Power Switch

No.	Category(1)	Category(2)	Item	Item Name	Picture	Description
4	HCR-5	TP	EP16-002535A	PCB,LCD-HCR TP AD BOARD		
5	HCR-5	TP	AM16-001711B	ASSY,BOARD-HCR TP EMO SWITCH_B		Emergency Switch
6	HCR-5	TP	AM16-001713A	ASSY,CABLE-HCR TP MAIN CABLE		Main Cable

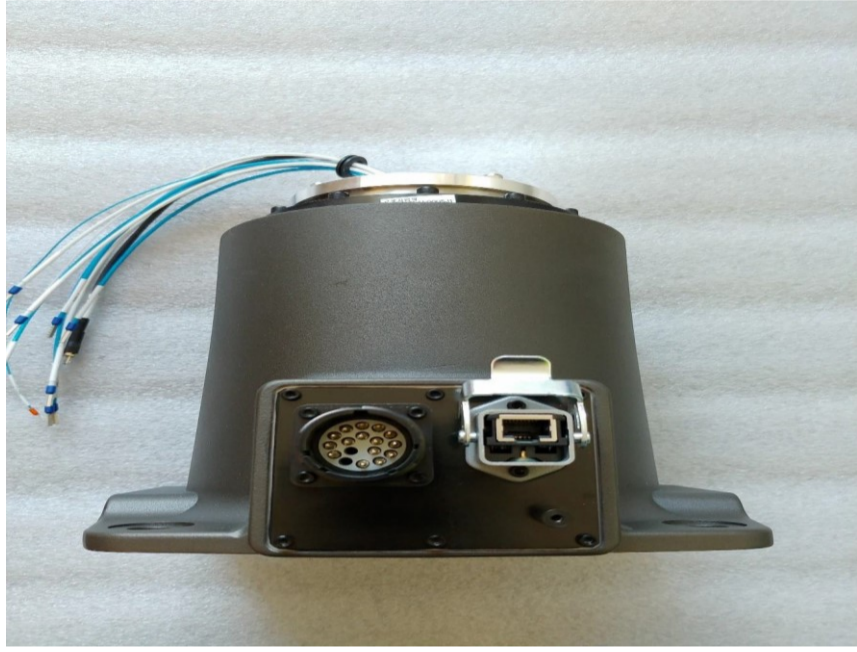
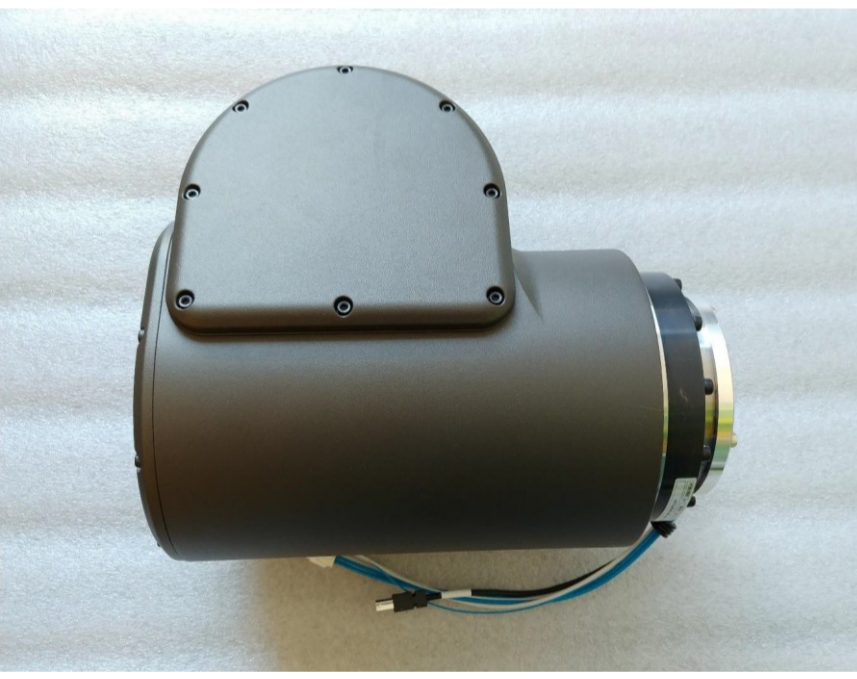
7. HCR-12 BODY

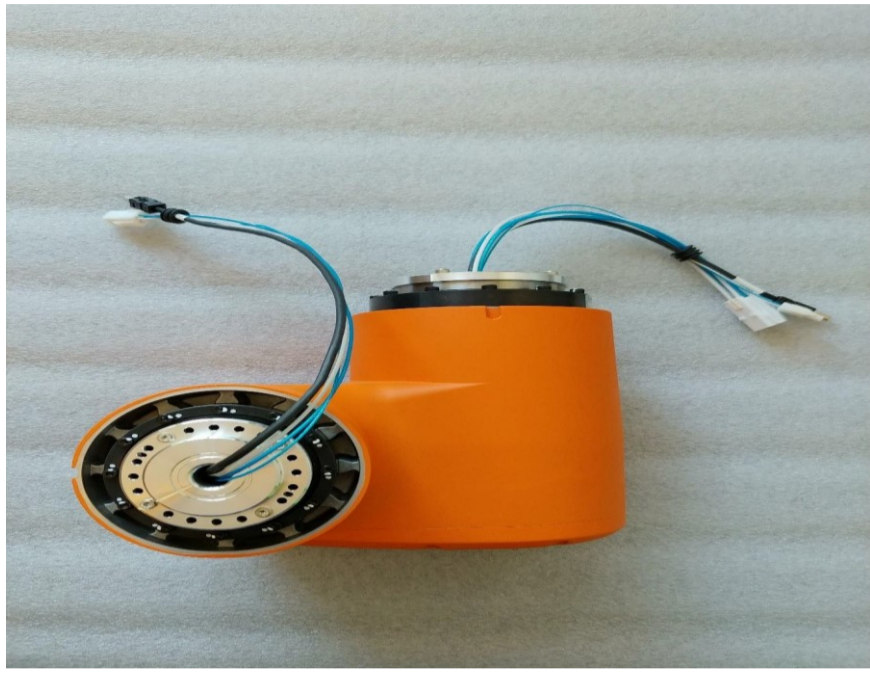
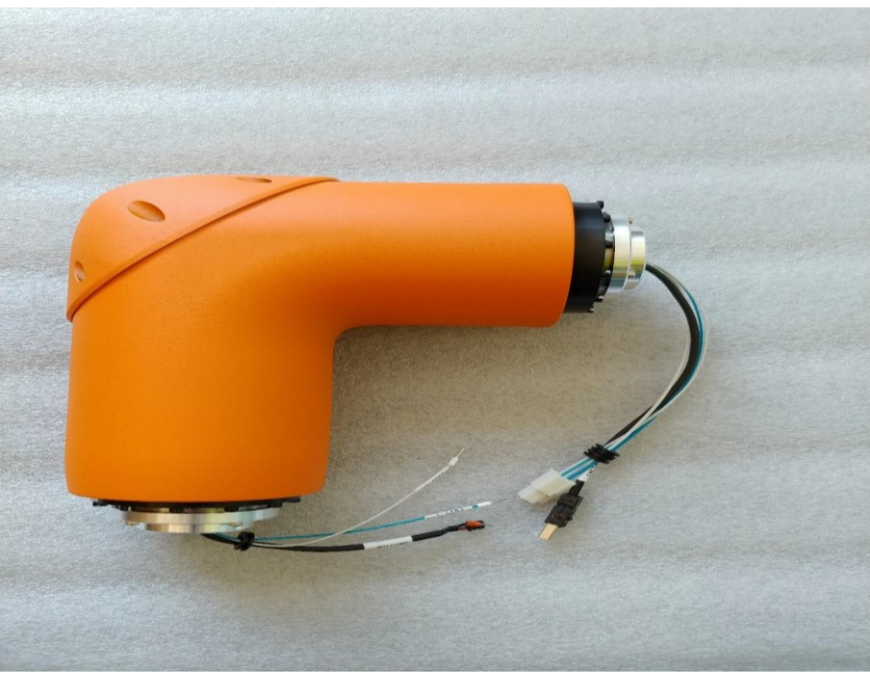
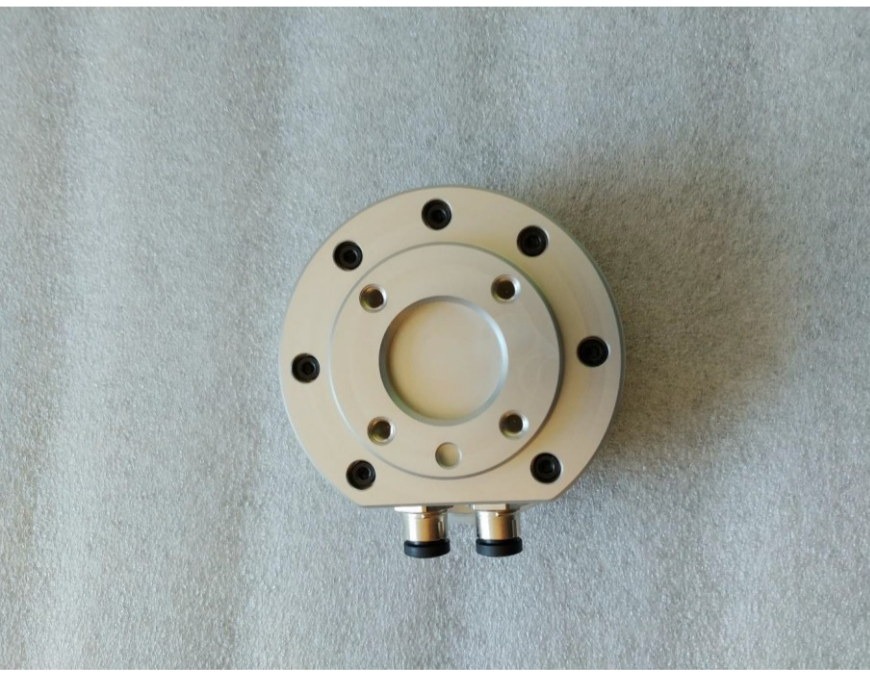
No.	Category(1)	Category(2)	Part Number	Part Name	Picture	Description
1	HCR-12	BODY	AM16-001845A	ASSY,BASE-HCR12-DO100-J1_ASSY		JOINT 1 ASS'Y
2	HCR-12	BODY	AM16-001859A	ASSY,BASE-HCR12-DO200-J2_ASSY		JOINT 2 ASS'Y

No.	Category(1)	Category(2)	Part Number	Part Name	Picture	Description
3	HCR-12	BODY	AM16-001869A	ASSY,BASE-HCR12-DO300-J3_J4_ASSY		JOINT 3 and JOINT 4 ASS'Y (It can't be seperated)
4	HCR-12	BODY	AM16-001890A	ASSY,BASE-HCR12-DO500-J5_J6_ASSY		JOINT 5 and JOINT 6 ASS'Y (It can't be seperated)
5	HCR-12	BODY	AM16-001895A	ASSY,BASE-HCR12-DO700-TOOL_IO_ASSY		TOOL ASS'Y

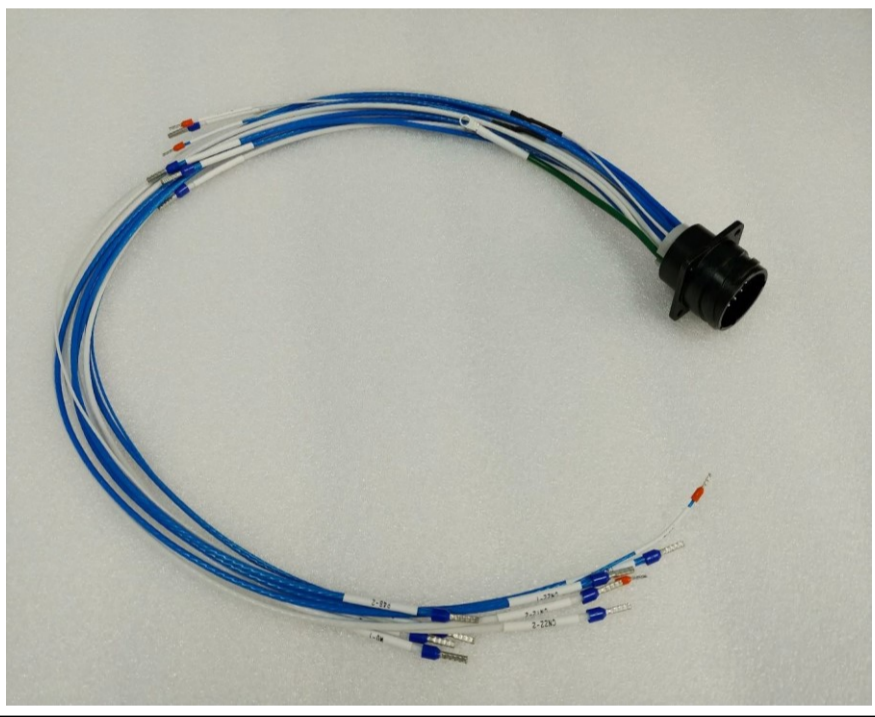
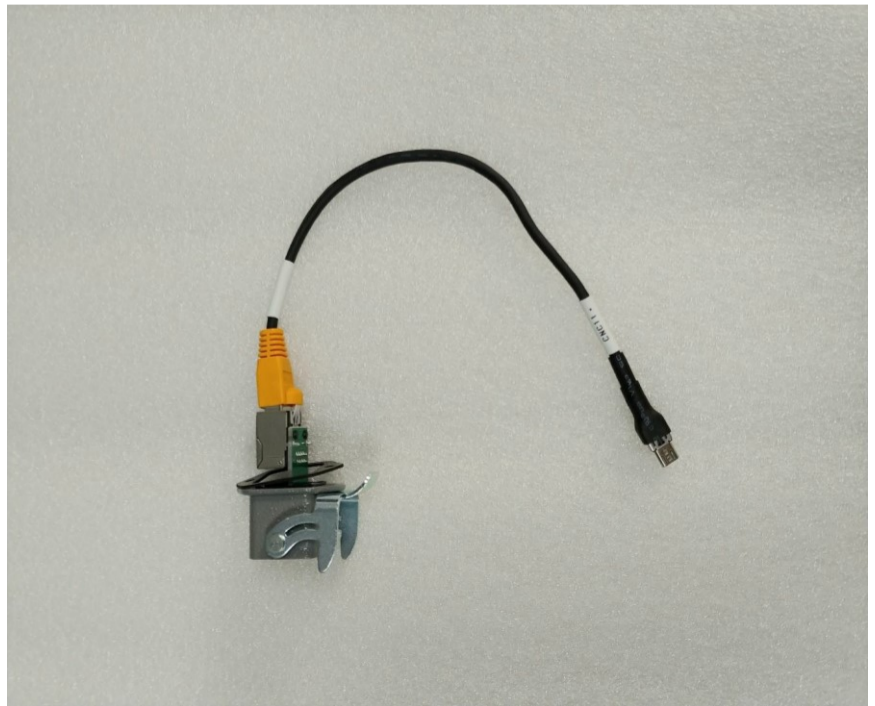

No.	Category(1)	Category(2)	Part Number	Part Name	Picture	Description
6	HCR-12	BODY	EP05-002300	BUNDLE TOOL IO 12pin CABLE		
7	HCR-12	BODY	AM16-001897A	ASSY,BASE-HCR12- DO700_LED_RING_ASSY		LED Ring
8	HCR-12	BODY	AM16-001726B	ASSY,CABLE-HCR05-B02- B_EX_ETHERCAT		TOOL Ethercat Port

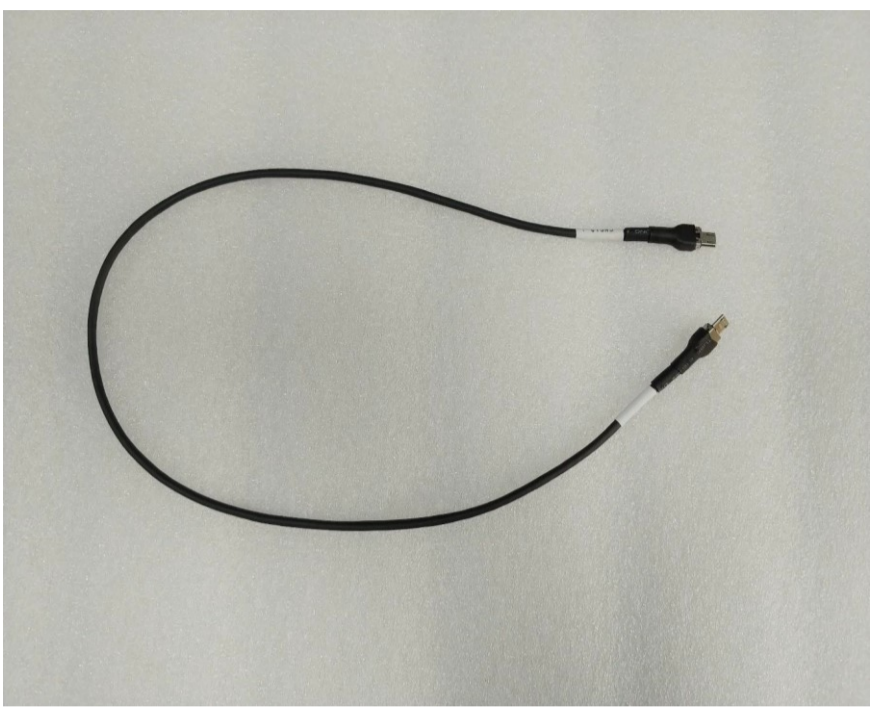
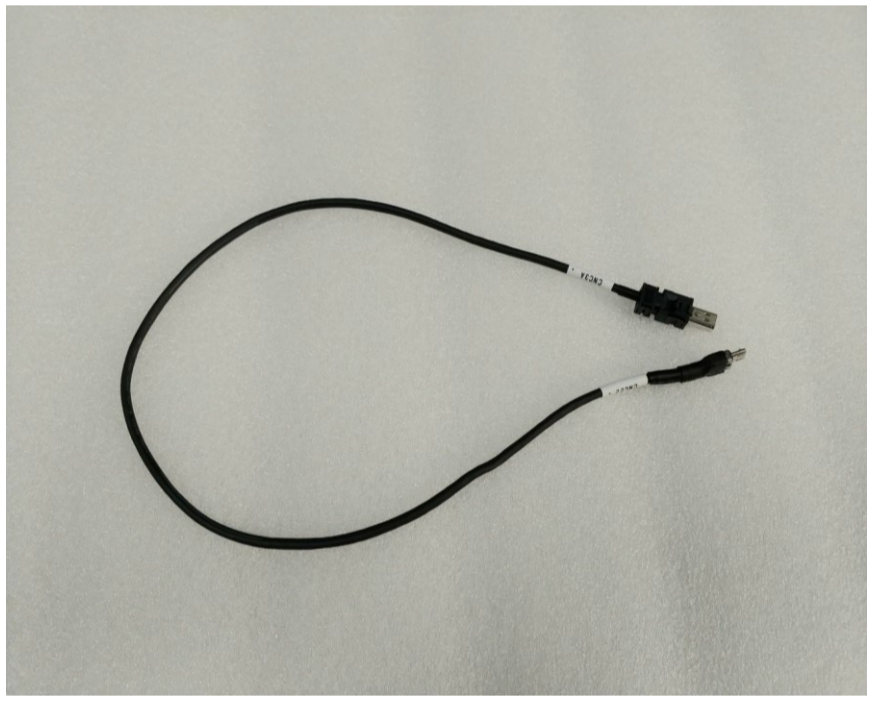
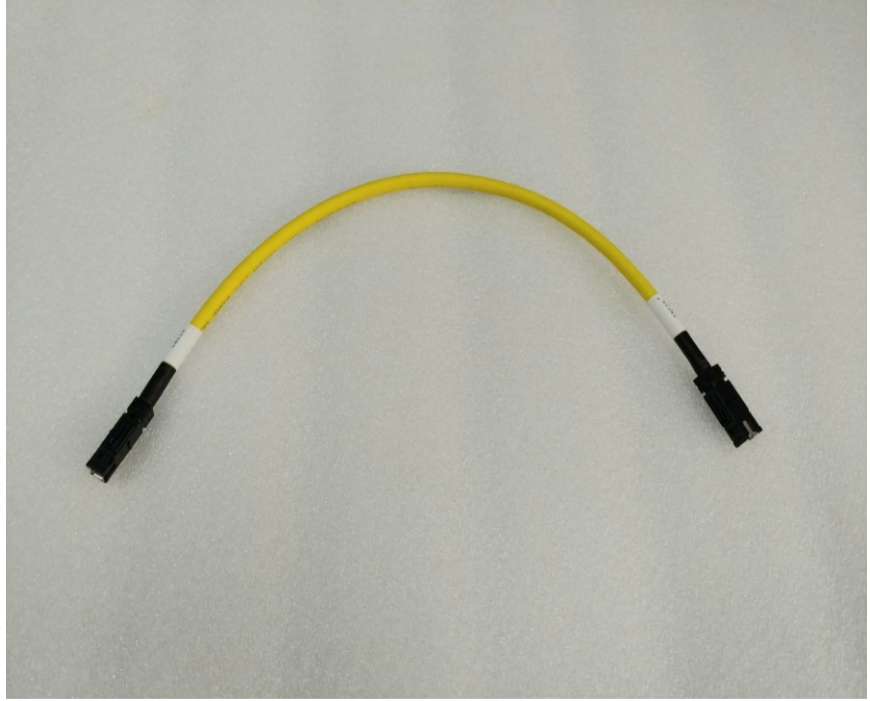
No.	Category(1)	Category(2)	Part Number	Part Name	Picture	Description
9	HCR-12	BODY	AM16-001660B	ASSY,CABLE-HCR05-B02-A_EX_PWR_IO		TOOL I/O Port
10	HCR-12	BODY	AM16-001927A	ASSY,CABLE-HCR12-SM01-A_MAIN CNP_SM01_PW		J1 Power Port
11	HCR-12	BODY	AM16-001902A	ASSY,CABLE-HCR12-C01-A_ECAT_J0-J1		J1 Ethercat Port

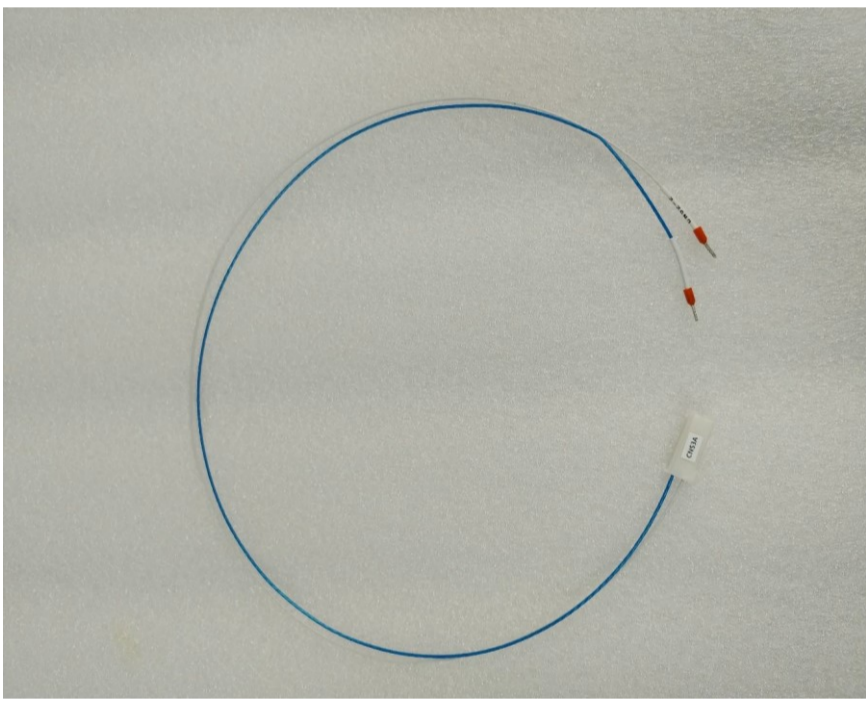
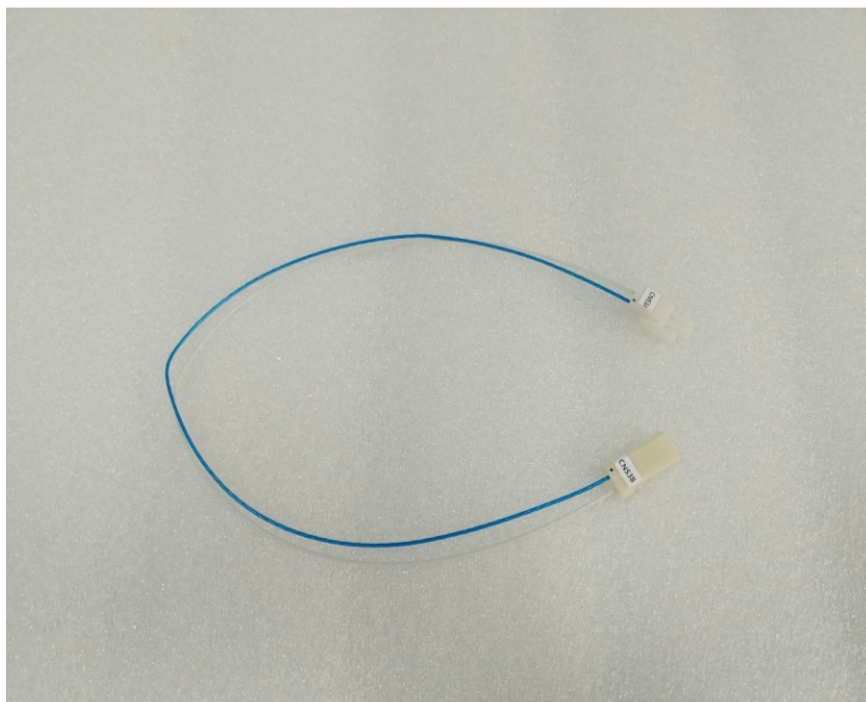

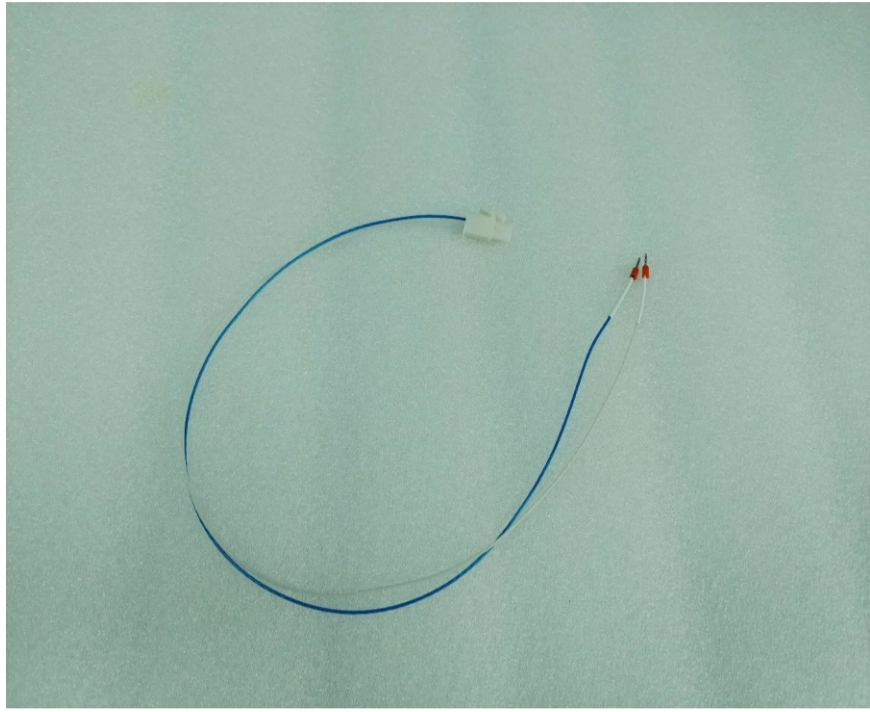
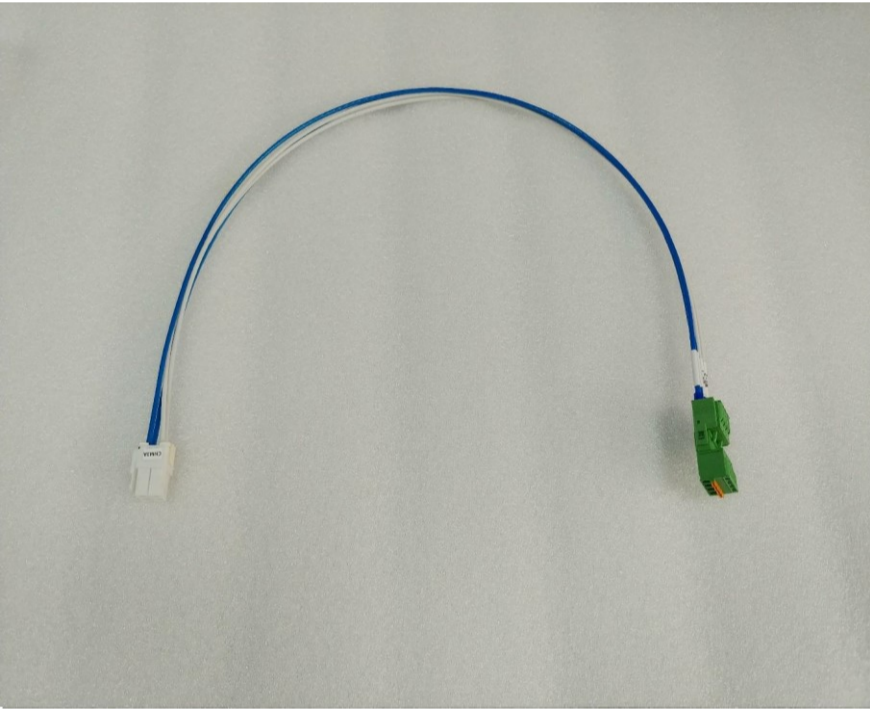
No.	Category(1)	Category(2)	Part Number	Part Name	Picture	Description
12	HCR-12	BODY	AM16-001900A	ASSY,CABLE-HCR12-C12-A_ECAT_J1-J2		J1-J2 Communication Cable A
13	HCR-12	BODY	AM16-001901A	ASSY,CABLE-HCR12-C23-A_ECAT_J2-J3-A		J2-J3 Communication Cable A
14	HCR-12	BODY	AM16-001906A	ASSY,CABLE-HCR12-C23-B_ECAT_J2-J3-B		J2-J3 Communication Cable B

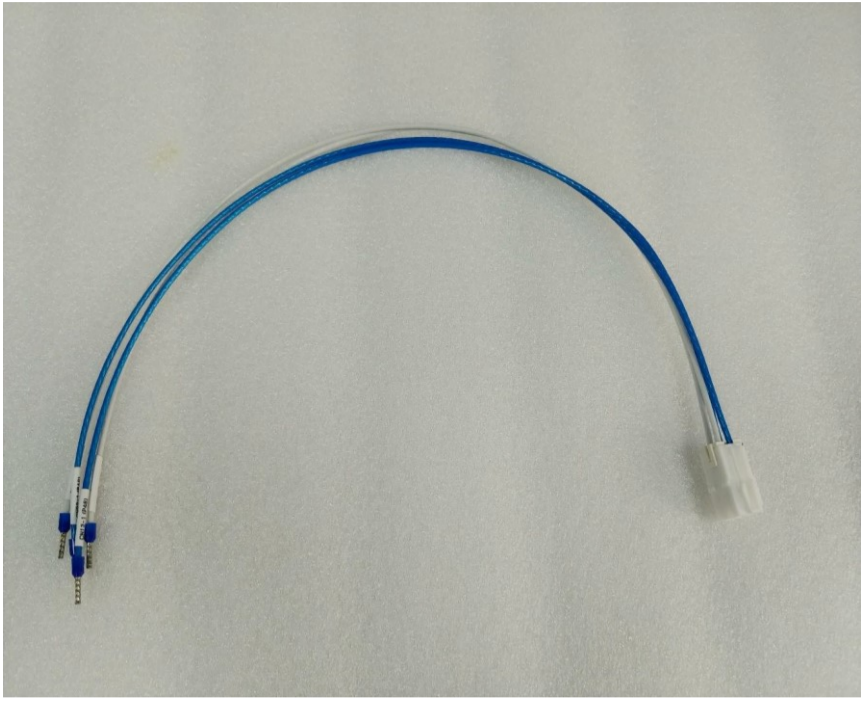

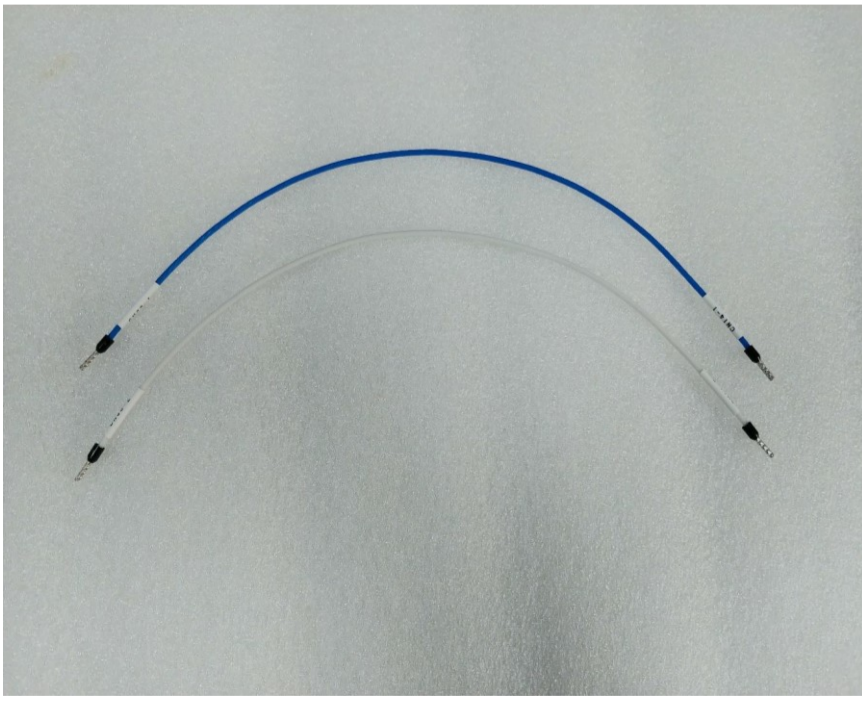
No.	Category(1)	Category(2)	Part Number	Part Name	Picture	Description
15	HCR-12	BODY	AM16-001908A	ASSY,CABLE-HCR12-C23-C_ECAT_J2-J3-C		J2-J3 Communication Cable C
16	HCR-12	BODY	AM16-001919A	ASSY,CABLE-HCR12-S23-A_S PW_J2-J3-A		J2-J3 Power Cable (S-A)
17	HCR-12	BODY	AM16-001922A	ASSY,CABLE-HCR12-S23-B_S PW_J2-J3-B		J2-J3 Power Cable (S-B)

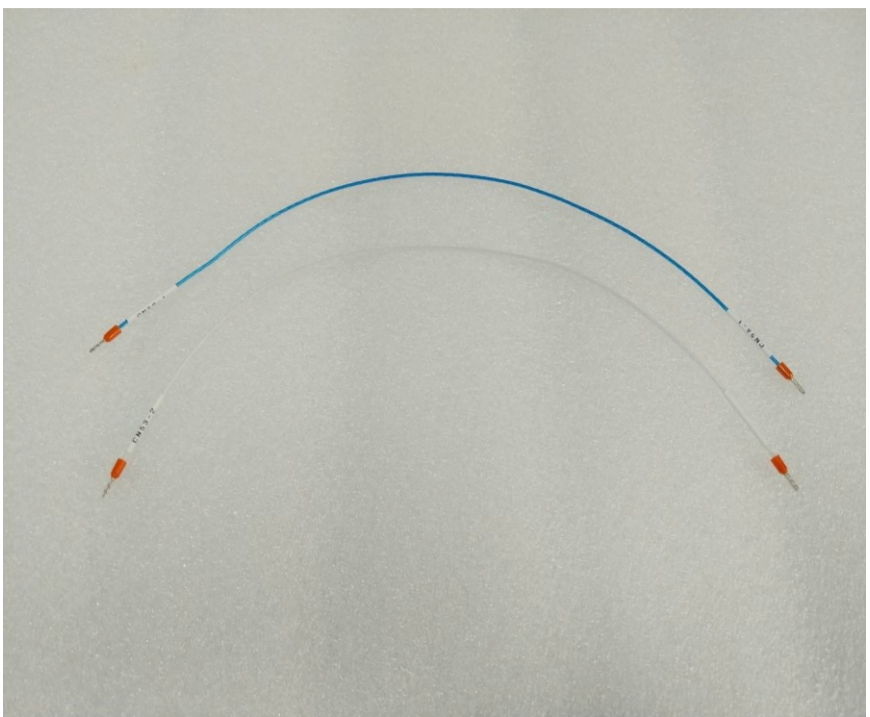
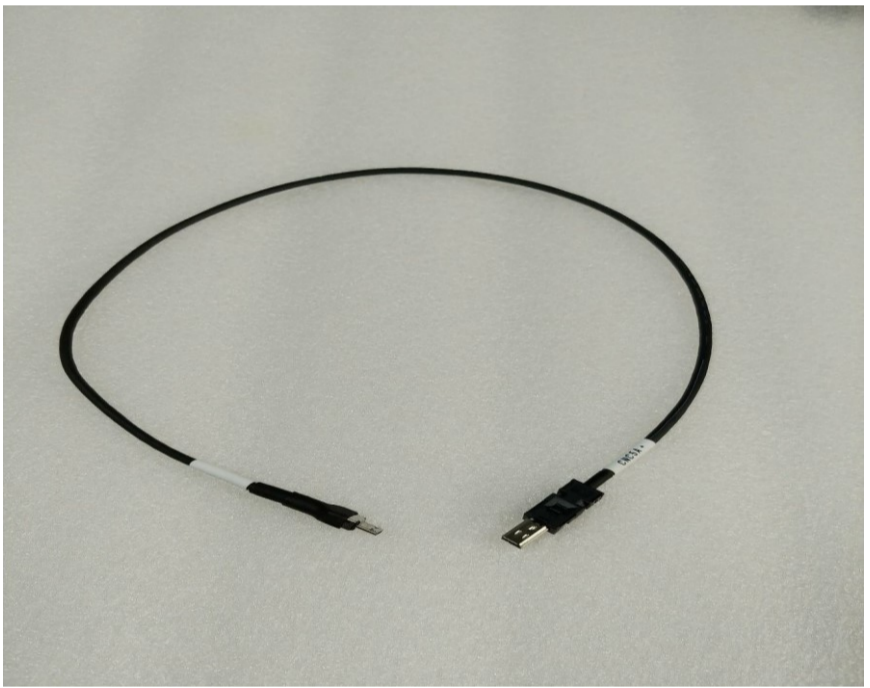
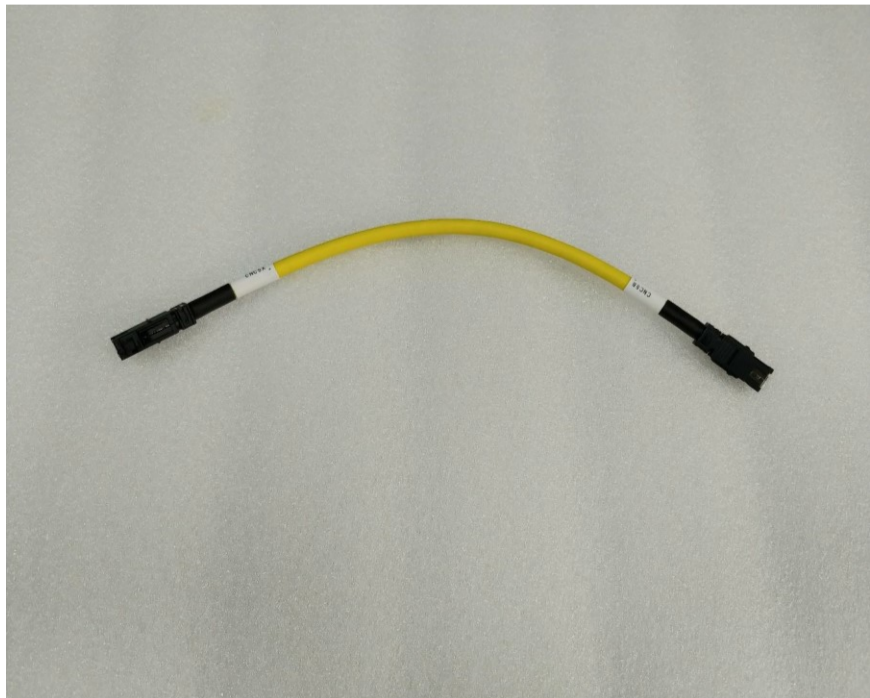
No.	Category(1)	Category(2)	Part Number	Part Name	Picture	Description
18	HCR-12	BODY	AM16-001924A	ASSY,CABLE-HCR12-S23-C_S PW_J2-J3-C		J2-J3 Power Cable (S-C)
19	HCR-12	BODY	AM16-001918A	ASSY,CABLE-HCR12-M23-A_M PW_J2-J3-A		J2-J3 Power Cable (M-A)
20	HCR-12	BODY	AM16-001915A	ASSY,CABLE-HCR12-M23-B_M PW_J2-J3-B		J2-J3 Pwer Cable (M-B)

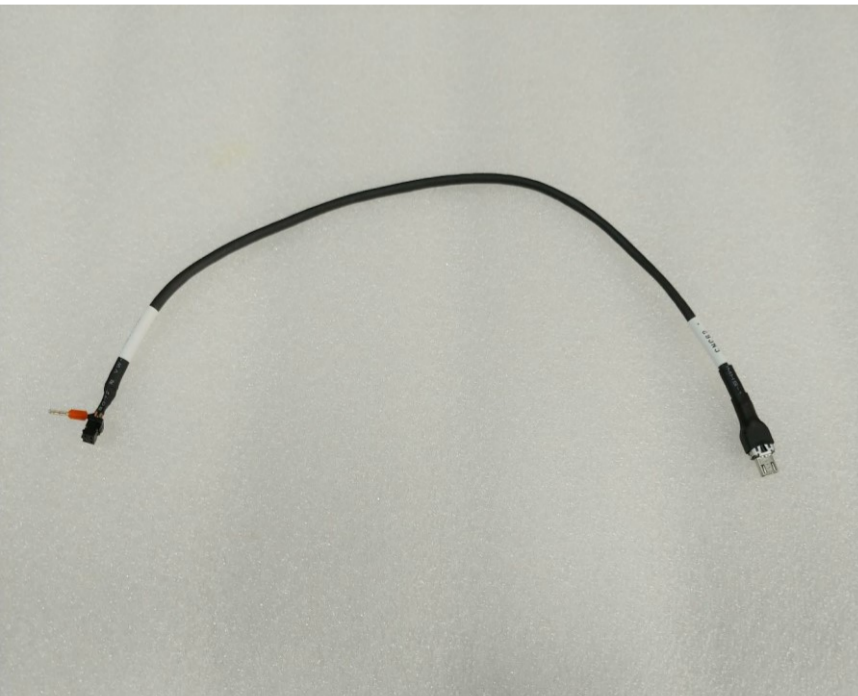

No.	Category(1)	Category(2)	Part Number	Part Name	Picture	Description
21	HCR-12	BODY	AM16-001917A	ASSY,CABLE-HCR12-M23-C_M PW_J2-J3-C		J2-J3 Power Cable (M-C)
22	HCR-12	BODY	AM16-001910A	ASSY,CABLE-HCR12-C34-A_ECAT_J3-J4		J3-J4 Communication cable A
23	HCR-12	BODY	AM16-001920A	ASSY,CABLE-HCR12-M34-A_M PW_J3-J4		J3-J4 Power Cable (M-A)

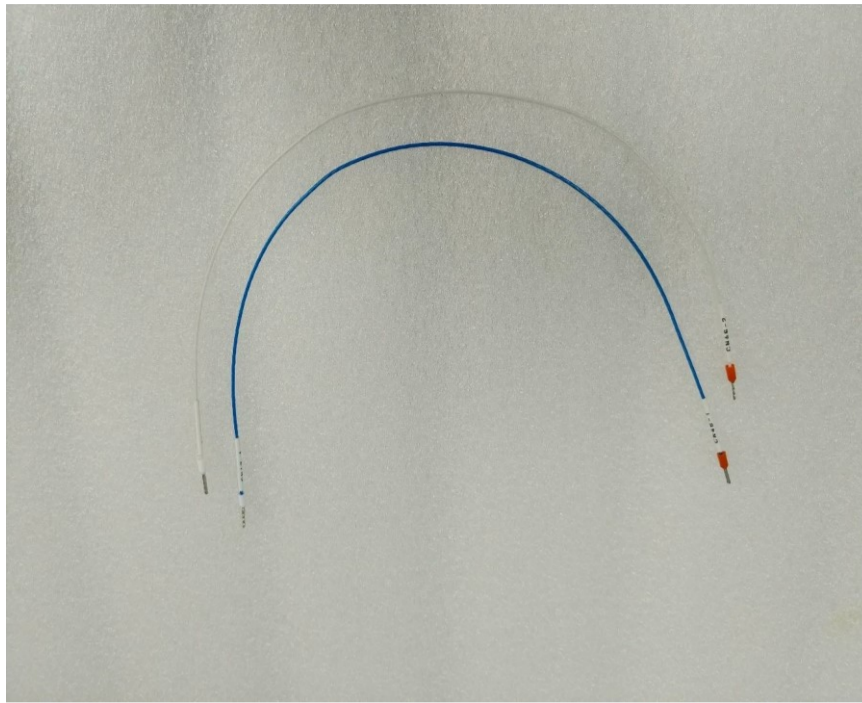

No.	Category(1)	Category(2)	Part Number	Part Name	Picture	Description
24	HCR-12	BODY	AM16-001925A	ASSY,CABLE-HCR12-S34-A_S PW_J3-J4-A		J3-J4 Power Cable (S-A)
25	HCR-12	BODY	AM16-001911A	ASSY,CABLE-HCR12-C45-A_ECAT_J4-J5-A		J4-J5 Communication Cable A
26	HCR-12	BODY	AM16-001909A	ASSY,CABLE-HCR12-C45-B_ECAT_J4-J5-B		J4-J5 communication Cable B



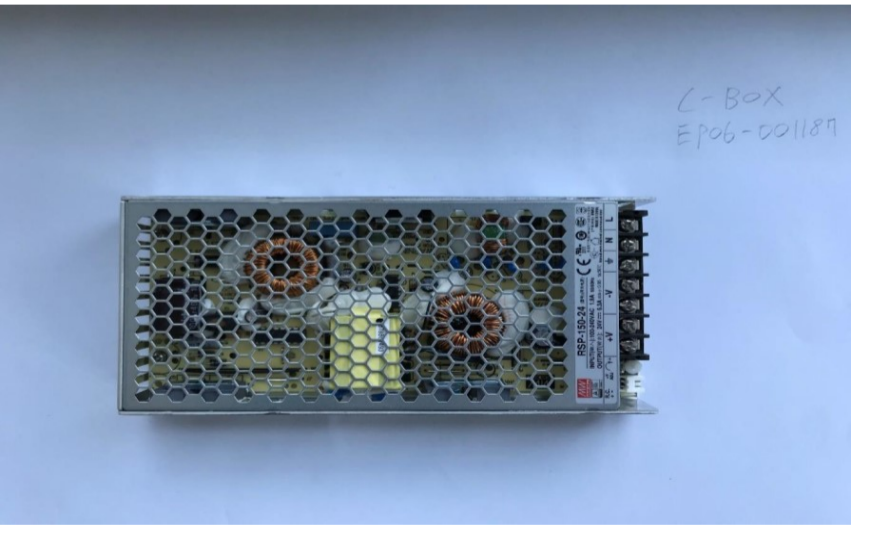

No.	Category(1)	Category(2)	Part Number	Part Name	Picture	Description
27	HCR-12	BODY	AM16-001912A	ASSY,CABLE-HCR12-C45-C_ECAT_J4-J5-C		J4-J5 Communication Cable C
28	HCR-12	BODY	AM16-001913A	ASSY,CABLE-HCR12-C56-A_ECAT_J5-J6		J5-J6 Communication Cable A
29	HCR-12	BODY	AM16-001914A	ASSY,CABLE-HCR12-C6E-A_ECAT_J6-E		J6-Tool Communication cable

No.	Category(1)	Category(2)	Part Number	Part Name	Picture	Description
30	HCR-12	BODY	AM16-001923B	ASSY,CABLE-HCR12-S6E-A_S PW_J6-E		J6-Tool Power cable
31	HCR-12	BODY	AM03-026317A	ASSY,ELECTRIC-HCR5-BRK_KIT_ELECTRIC_ASSY		Brake Release Kit

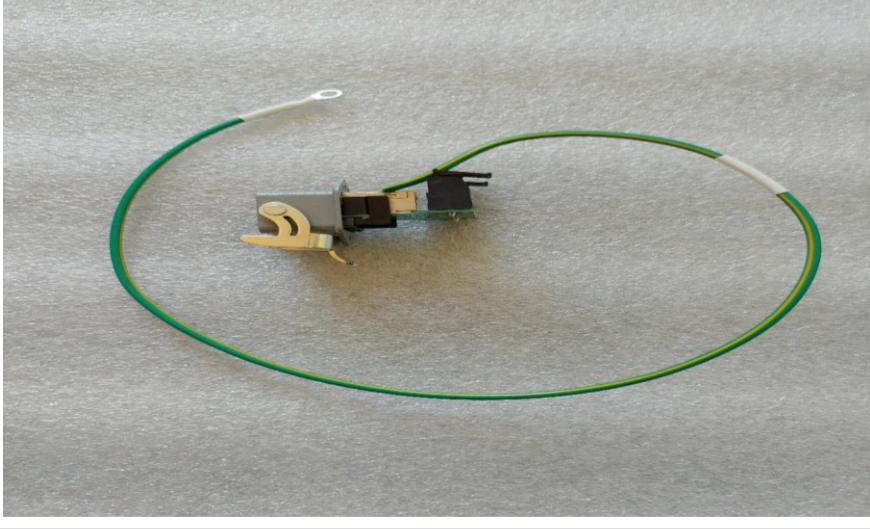

8. HCR-12 Controller

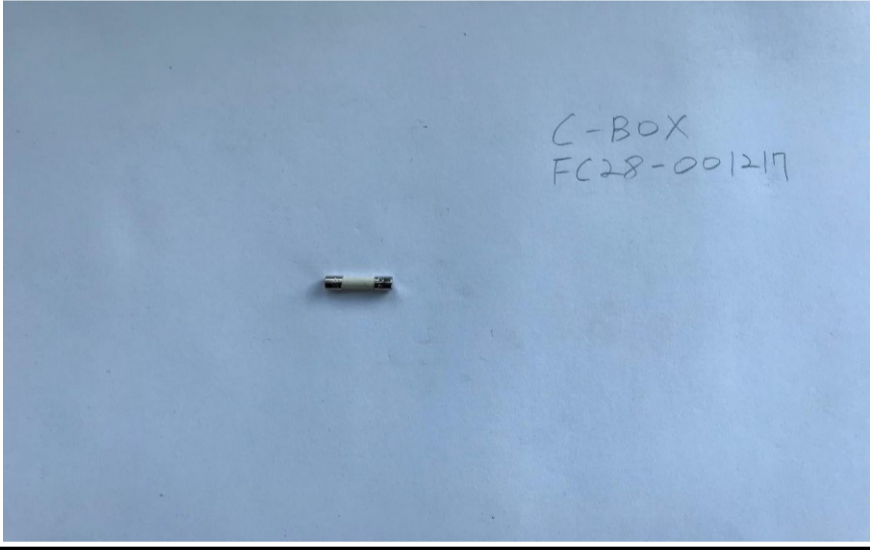
No.	Category(1)	Category(2)	Part Number	Part Name	Picture	Description
1	HCR-12	C-BOX	CD02-001026	INDUSTRIAL EMBEDDED PC_WEBS-2190-E3845	 A photograph of a black industrial embedded PC board. It features a variety of ports on its front panel, including a green audio jack, a blue USB port, two RJ45 Ethernet ports, a D-sub connector, and a power jack. Handwritten text in the top right corner of the image reads "C-Box CD02-001026".	EPC
2	HCR-12	C-BOX	EP06-001117	UPS/SMPS-RSP-2000	 A photograph of a yellow 48V power supply unit. It is a rectangular metal chassis with a label on the top surface that includes technical specifications and safety warnings. The label also features the AMM logo. The unit has several terminals on the right side for electrical connections.	48V Power Supply
3	HCR-12	C-BOX	EP06-001187	SMPS(24V)	 A photograph of a 24V power supply unit with a silver metal chassis and a perforated front panel. The internal components, including capacitors and a transformer, are visible through the holes. Handwritten text in the top right corner of the image reads "C-Box EP06-001187".	24V Power Supply

No.	Category(1)	Category(2)	Part Number	Part Name	Picture	Description
4	HCR-12	C-BOX	EP07-002449	EMC FILTER		
5	HCR-12	C-BOX	EP06-002974B	BOX,CONTROL-C-BOX FAN ASS'Y FUSE		FAN
6	HCR-12	C-BOX	AM16-001716A	ASS'Y,CABLE-BOX-SURGE FILTER ASS'Y		
7	HCR-12	C-BOX	AM16-001717A	ASSY,CABLE-C-BOX-RJ45 HYBRID ASS'Y		

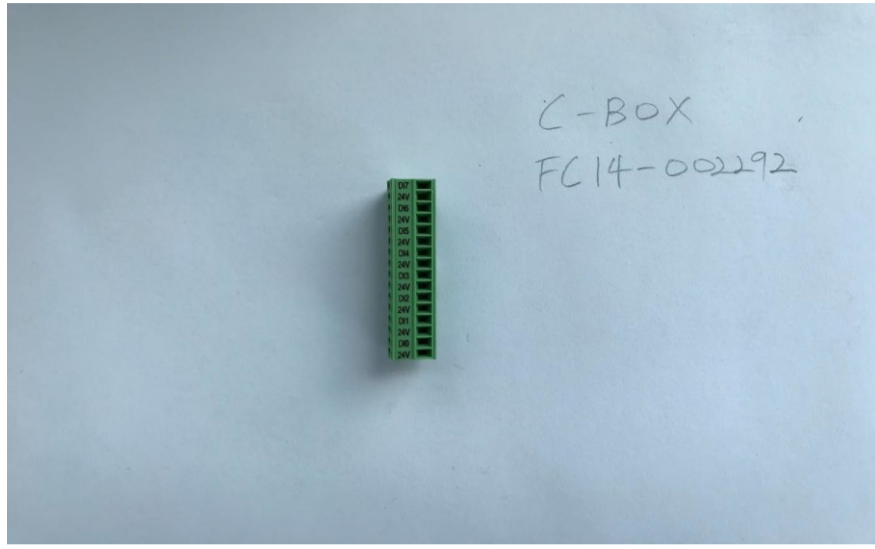
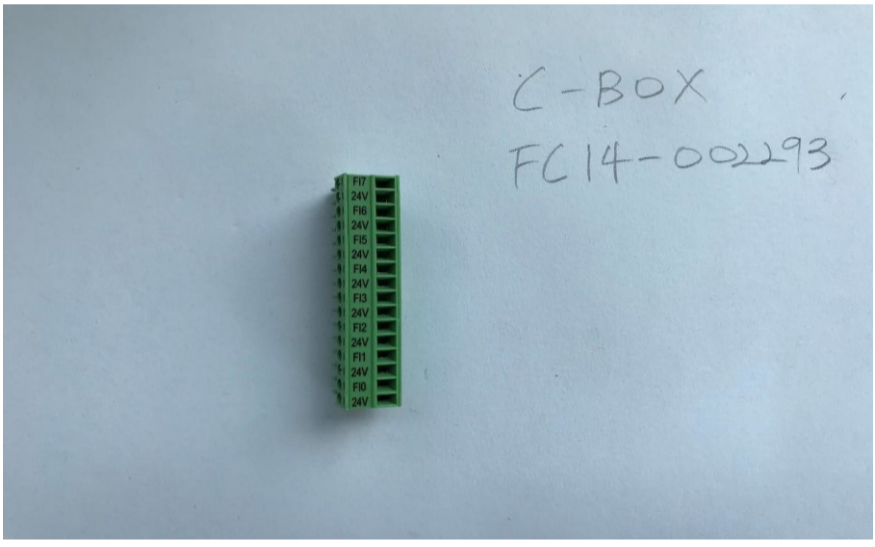
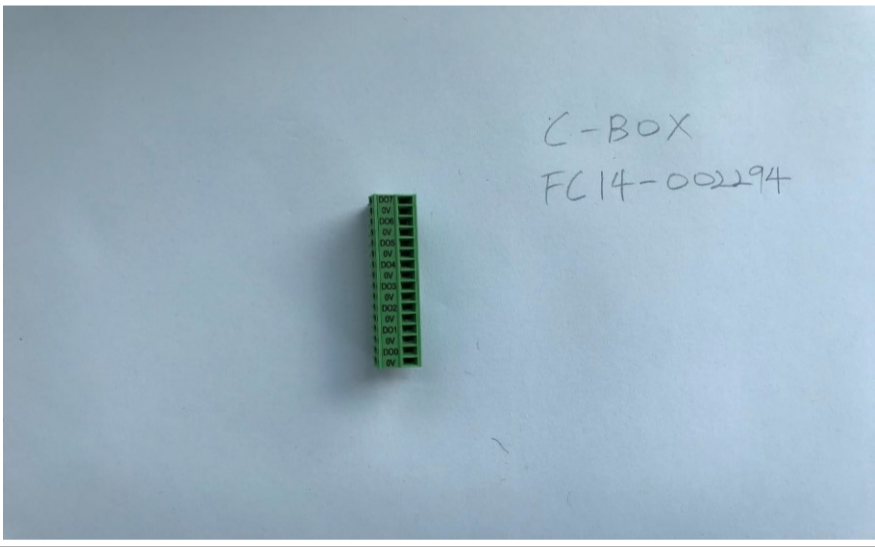
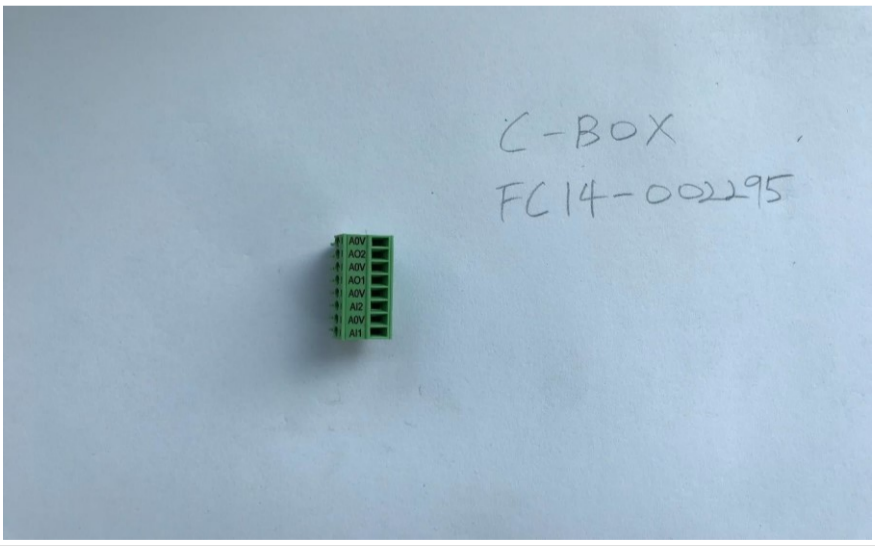

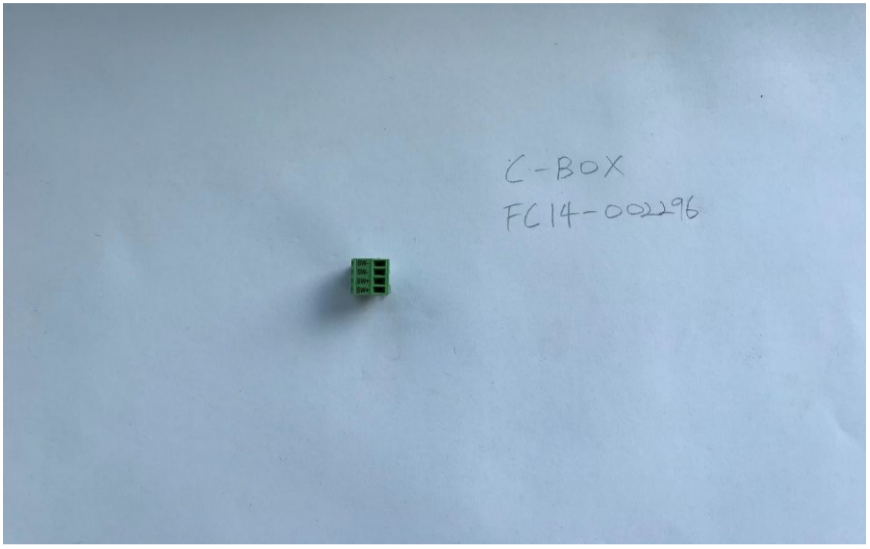
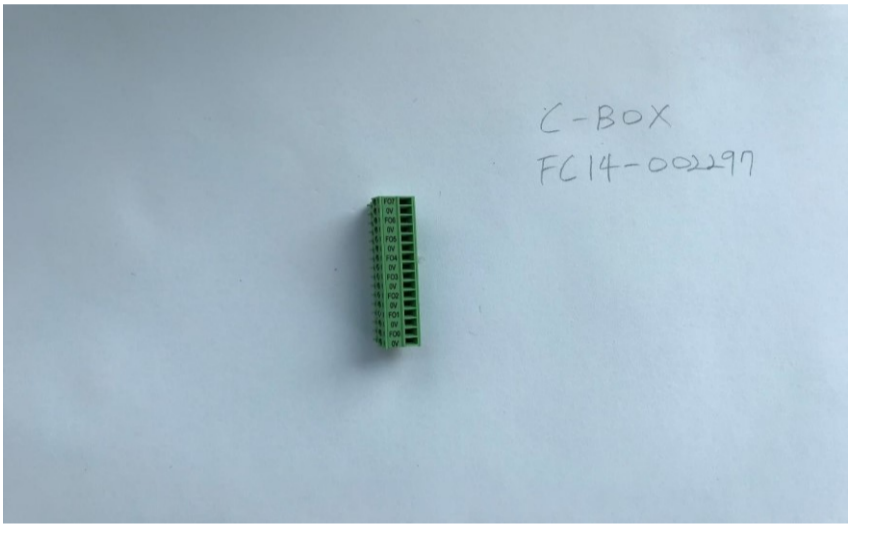
No.	Category(1)	Category(2)	Part Number	Part Name	Picture	Description
8	HCR-12	C-BOX	EP03-00109	ACCESSORY,CABLE-NMC-U7005Z		Ethernet Cable
9	HCR-12	C-BOX	FC28-001216	AC INLET		
10	HCR-12	C-BOX	FC28-001217	AC INLET FUSE		Inlet Fuse
11	HCR-12	C-BOX	EP07-002451	Magnetic Contactor		

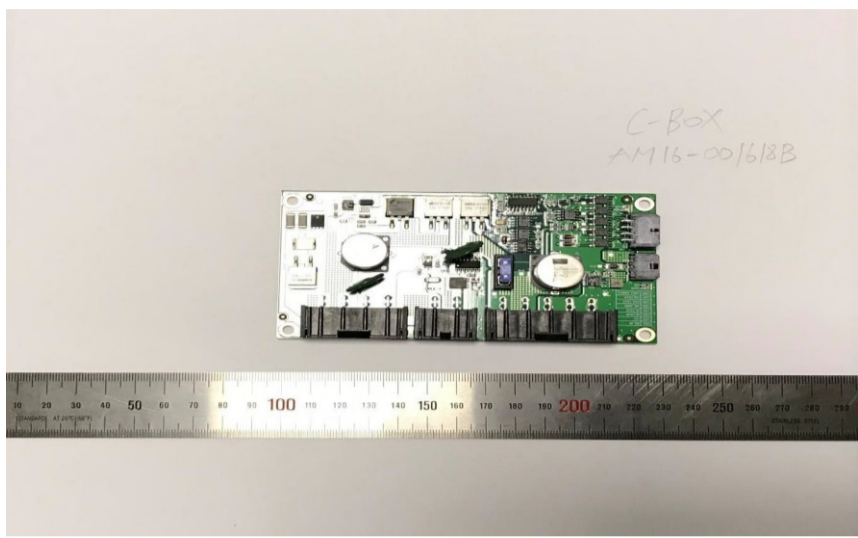
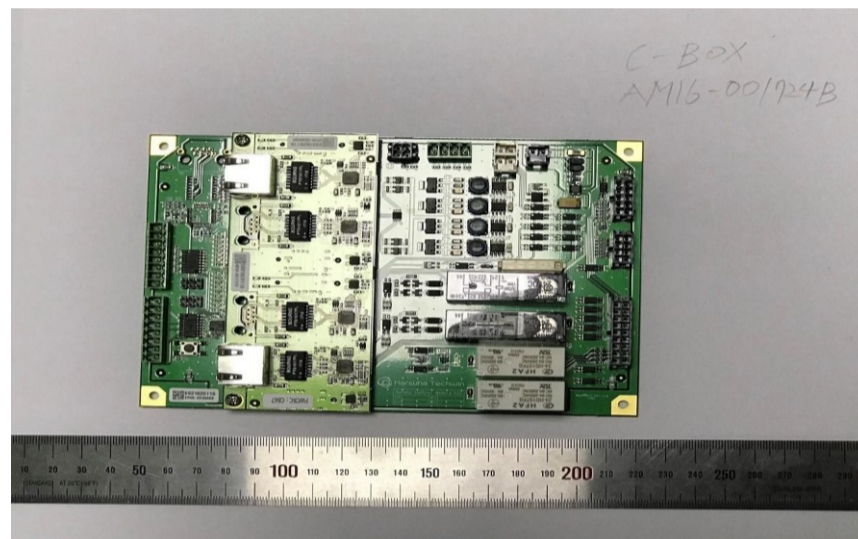
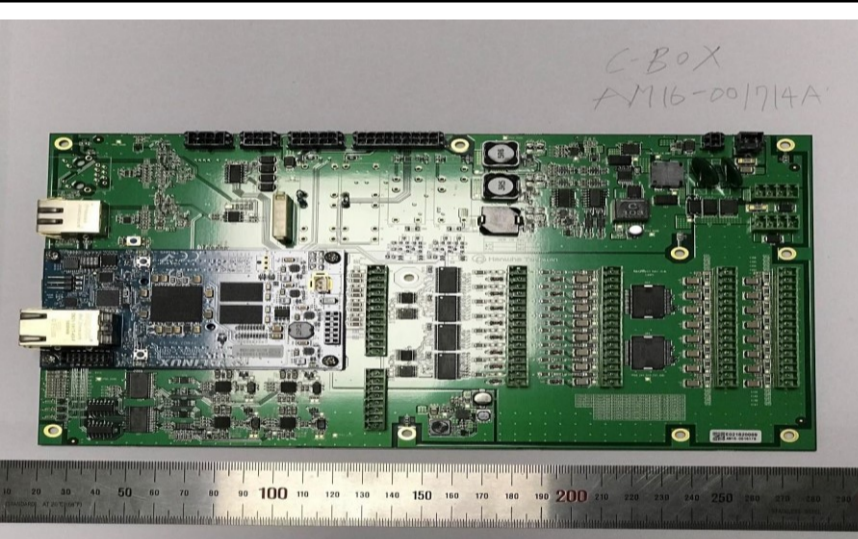

No.	Category(1)	Category(2)	Part Number	Part Name	Picture	Description
12	HCR-12	C-BOX	FC14-002292	IO BOARD_DI_CONNECTOR		Digital Input Connector
13	HCR-12	C-BOX	FC14-002293	IO BOARD_FI_CONNECTOR		Flexible Input Connector
14	HCR-12	C-BOX	FC14-002294	IO BOARD_DO_CONNECTOR		Digital Output Connector
15	HCR-12	C-BOX	FC14-002295	IO BOARD_AIO_CONNECTOR		Analog Input/Output Connector

No.	Category(1)	Category(2)	Part Number	Part Name	Picture	Description
16	HCR-12	C-BOX	FC14-002296	IO BOARD_SW_CONNECTOR	 C-BOX FC14-002296	
17	HCR-12	C-BOX	FC14-002297	IO BOARD_FO_CONNECTOR	 C-BOX FC14-002297	Flexible Output Connector
18	HCR-12	C-BOX	EP10-004039	AC POWER CORD(CHINA)	 EP10-4039	
19	HCR-12	C-BOX	EP10-003939	AC POWER CORD(KOREA)	 C-BOX EP10-003939	

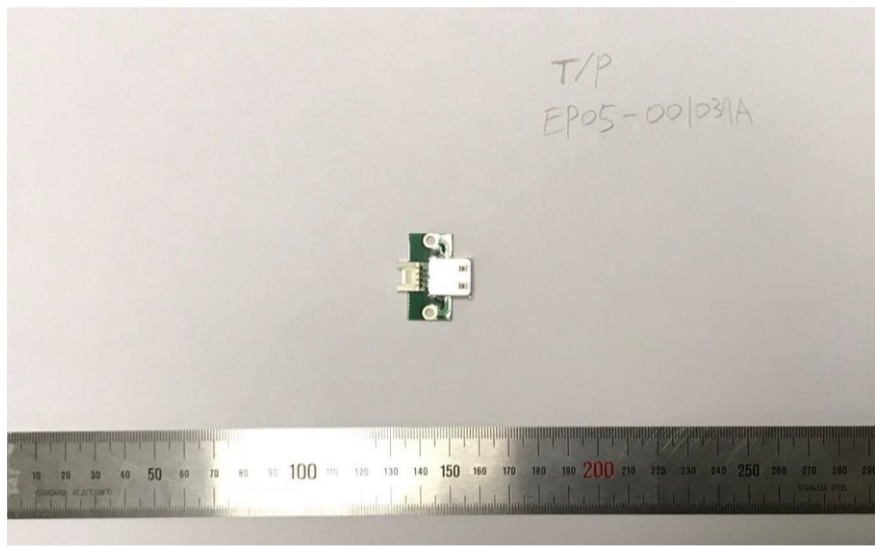
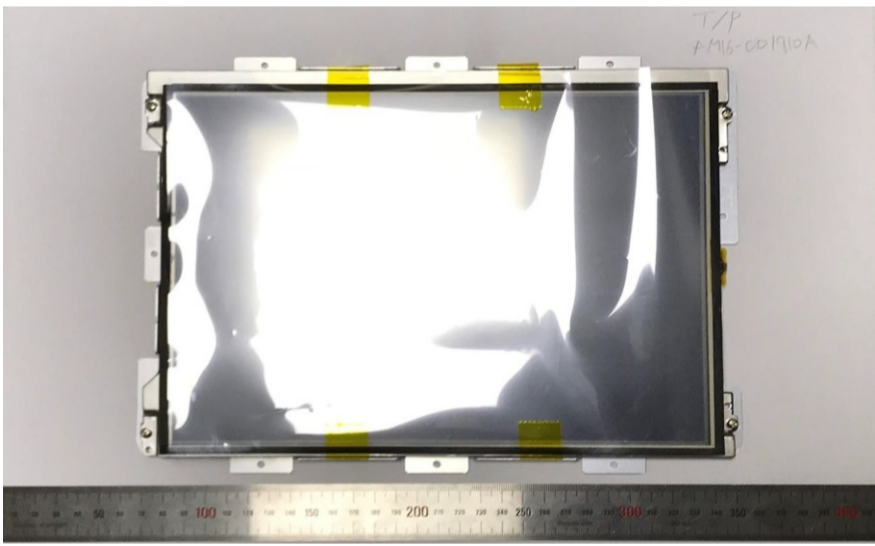
No.	Category(1)	Category(2)	Part Number	Part Name	Picture	Description
20	HCR-12	C-BOX	AM16-001618B	RESISTOR BOARD	 A photograph of a small green printed circuit board (PCB) populated with various electronic components, primarily resistors. The board is oriented vertically. A ruler is placed below the board for scale, showing it is approximately 100mm wide. Handwritten text in the top right corner of the image reads "C-BOX" and "AM16-001618B".	
21	HCR-12	C-BOX	AM16-001724B	SAFETY-BOARD	 A photograph of a green PCB populated with numerous electronic components, including integrated circuits, capacitors, and connectors. The board is oriented vertically. A ruler is placed below the board for scale, showing it is approximately 100mm wide. Handwritten text in the top right corner of the image reads "C-BOX" and "AM16-001724B".	
22	HCR-12	C-BOX	AM16-002038A	ASS'Y,BOARD-HC-P_CONTROL	 A photograph of a large green PCB populated with a complex array of electronic components, including multiple integrated circuits, capacitors, and connectors. The board is oriented vertically. A ruler is placed below the board for scale, showing it is approximately 100mm wide. Handwritten text in the top right corner of the image reads "C-BOX" and "AM16-001714A".	

9. HCR-12 TP

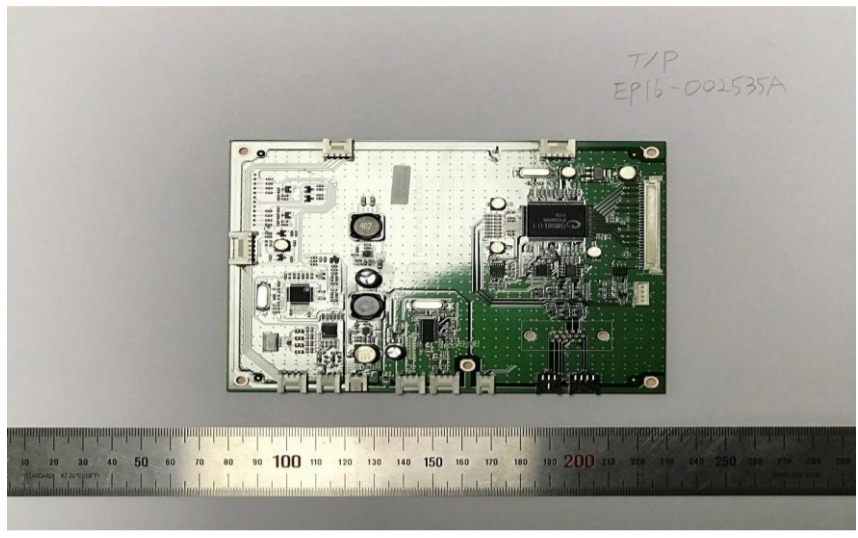
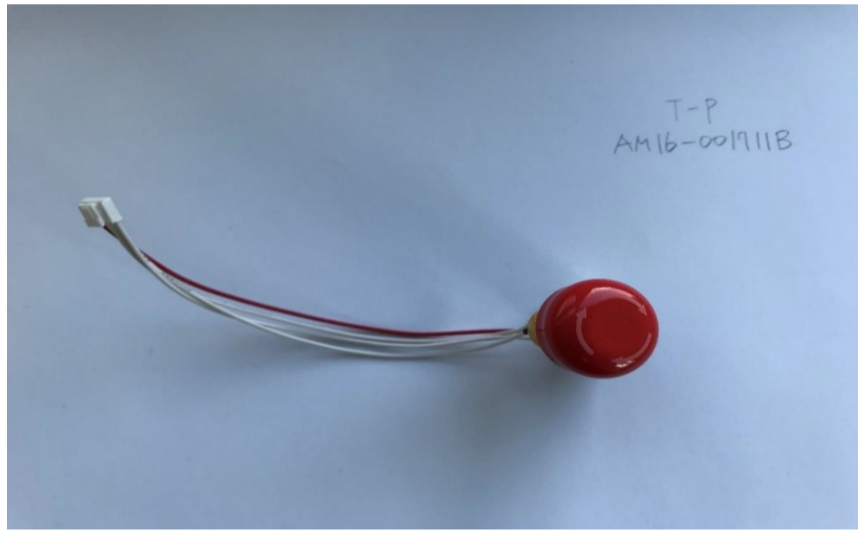
No.	Category(1)	Category(2)	Item	Item Name	Picture	Description
1	HCR-5	TP	EP05-001037A	ADAPTOR,CONNECTOR-USB		USB Connector
2	HCR-5	TP	AM16-001710A	ASSY,COVER-HCR TP LCD PANNEL		LCD
3	HCR-5	TP	EP20-001039A	SWITCH,PUSH-HCR TP STANDBY ASSY		Power Switch

No.	Category(1)	Category(2)	Item	Item Name	Picture	Description
4	HCR-5	TP	EP16-002535A	PCB,LCD-HCR TP AD BOARD		
5	HCR-5	TP	AM16-001711B	ASSY,BOARD-HCR TP EMO SWITCH_B		Emergency Switch
6	HCR-5	TP	AM16-001713B	ASSY,CABLE-HCR TP MAIN CABLE_ONE		Main Cable