

### RONDA-REC-60-C

~60° + 60° rectangular beam with holder C compatible with LEDiL HEKLA

#### SPECIFICATION:

Dimensions	Ø 53.9 mm
Height	16.6 mm
Fastening	socket
ROHS compliant	yes ⓘ

#### MATERIALS:

Component	Type	Material	Colour	Finish
F15556_RONDA-REC-60	Single lens	PMMA	clear	
F15635_RONDA-HLD-C	Holder	PC	white	

#### ORDERING INFORMATION:

##### Quantities for one set:

Single lens	1
Holder	1

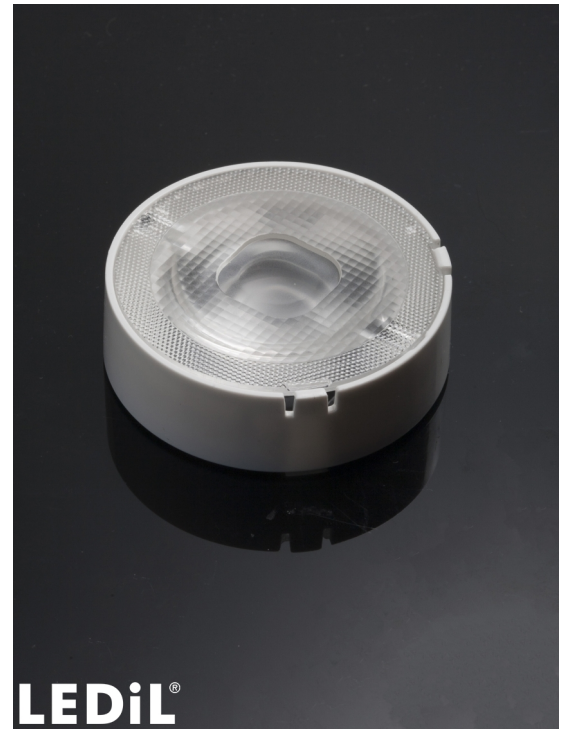



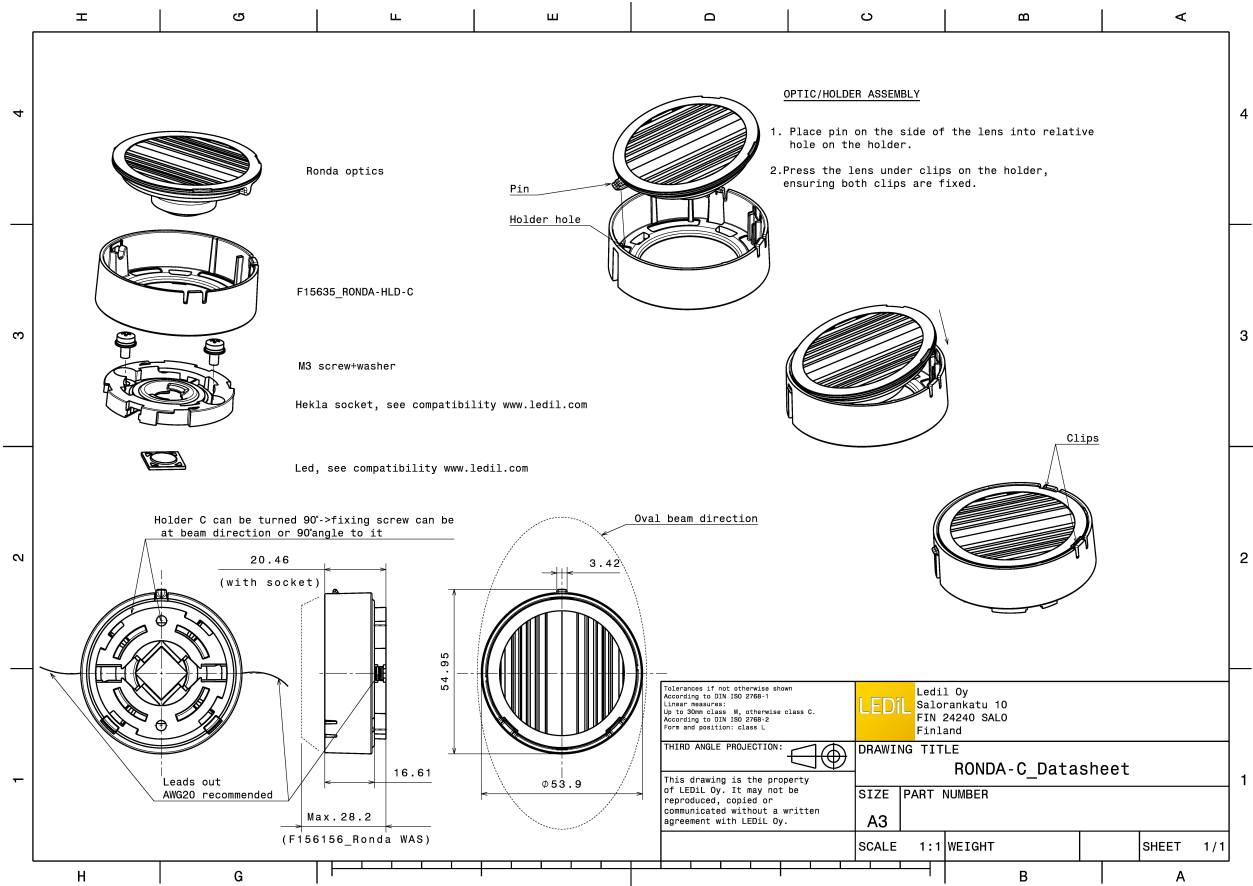



Component		Qty in box	MOQ	MPQ	Box weight (kg)
F15556_RONDA-REC-60	Single lens	420	120	30	6.7
» Box size: 480 x 280 x 300 mm					
F15635_RONDA-HLD-C	Holder	420	120	30	4.1
» Box size: 480 x 280 x 300 mm					

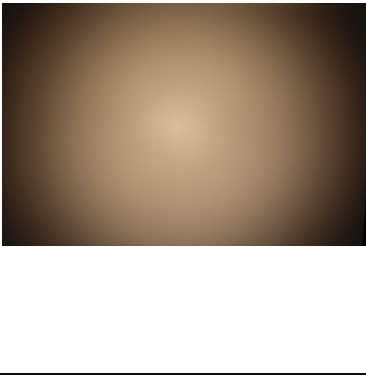
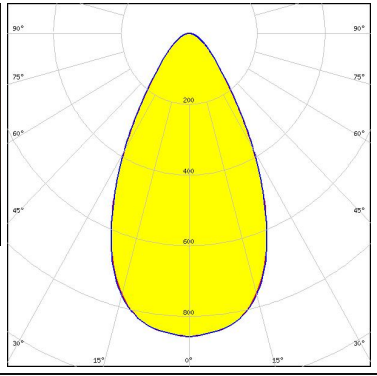

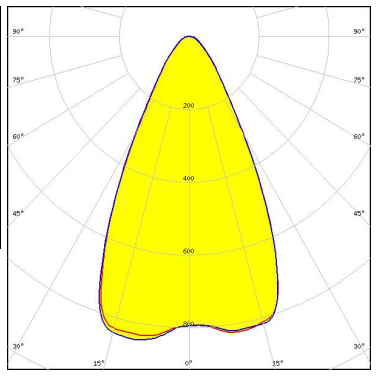

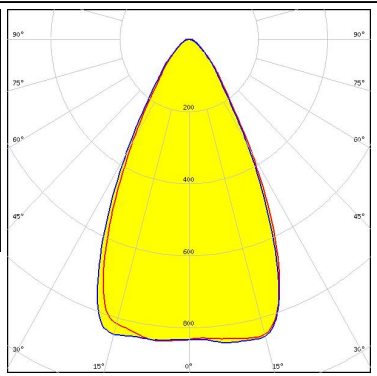

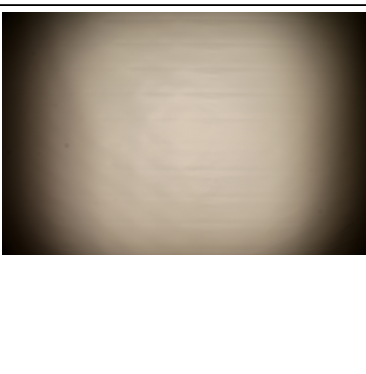
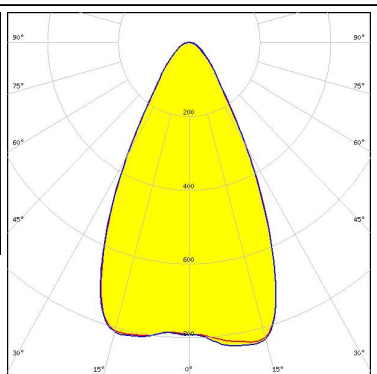

See also our general installation guide: [www.ledil.com/installation\\_guide](http://www.ledil.com/installation_guide)

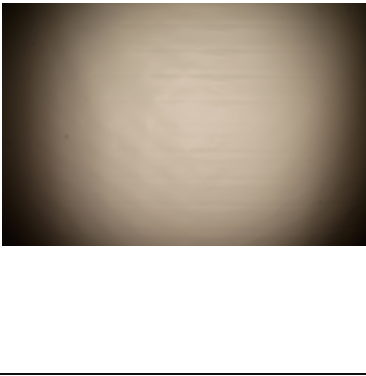
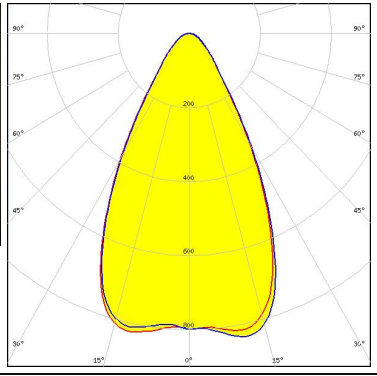

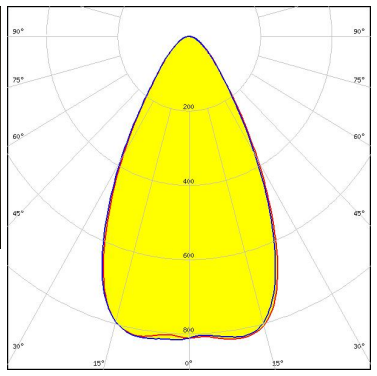

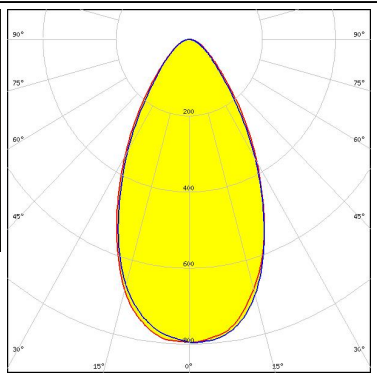

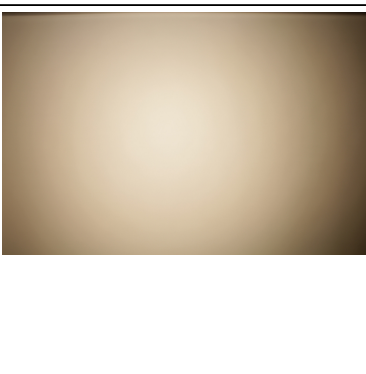
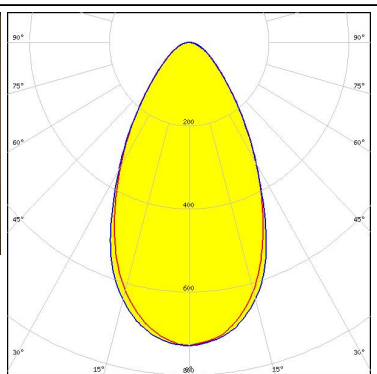
### OPTICAL RESULTS (MEASURED):

<p></p> <p>LED V11 HD Gen 8</p> <p>FWHM / FWTM 57.0° / 99.0°</p> <p>Efficiency 89 %</p> <p>Peak intensity 0.9 cd/lm</p> <p>LEDs/each optic 1</p> <p>Light colour White</p> <p>Required components: Bender Wirth: 633d Hekla</p>		
<p></p> <p>LED V4 HD Gen 7</p> <p>FWHM / FWTM 54.7 + 54.4° / 92.0 + 91.8°</p> <p>Efficiency 92 %</p> <p>Peak intensity 0.9 cd/lm</p> <p>LEDs/each optic 1</p> <p>Light colour White</p> <p>Required components: F15253_HEKLA-SOCKET-A</p>		
<p></p> <p>LED V6 Gen6</p> <p>FWHM / FWTM 56.0 + 57.0° / 92.0 + 93.0°</p> <p>Efficiency 92 %</p> <p>Peak intensity 0.9 cd/lm</p> <p>LEDs/each optic 1</p> <p>Light colour White</p> <p>Required components: F15253_HEKLA-SOCKET-A</p>		
<p></p> <p>LED V6 HD Gen 7</p> <p>FWHM / FWTM 56.4 + 56.5° / 95.4 + 95.6°</p> <p>Efficiency 91 %</p> <p>Peak intensity 0.9 cd/lm</p> <p>LEDs/each optic 1</p> <p>Light colour White</p> <p>Required components: F15255_HEKLA-SOCKET-C</p>		

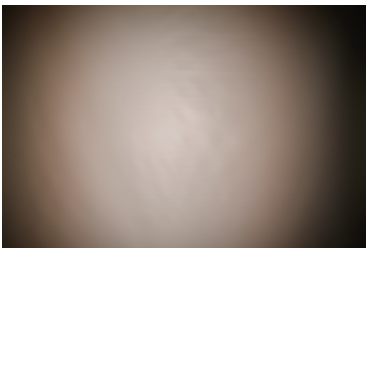
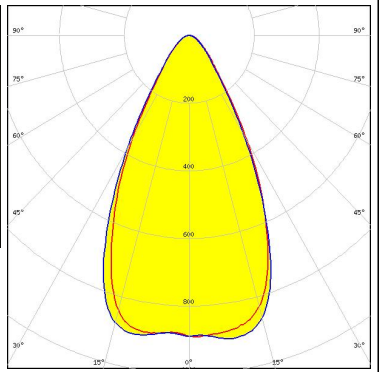
### OPTICAL RESULTS (MEASURED):

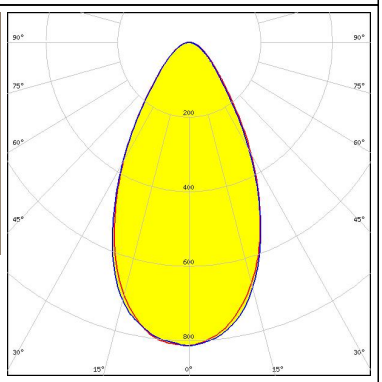
<p></p> <p>LED V9 HD Gen7</p> <p>FWHM / FWTM 57.7 + 56.8° / 96.3 + 94.5°</p> <p>Efficiency 89 %</p> <p>Peak intensity 0.8 cd/lm</p> <p>LEDs/each optic 1</p> <p>Light colour White</p> <p>Required components:</p>		
<p></p> <p>LED VERO10</p> <p>FWHM / FWTM 59.0° / 98.0°</p> <p>Efficiency 90 %</p> <p>Peak intensity 0.8 cd/lm</p> <p>LEDs/each optic 1</p> <p>Light colour White</p> <p>Required components: F15616_HEKLA-SOCKET-F</p>		
<p></p> <p>LED Vesta DTW 13mm (21W)</p> <p>FWHM / FWTM 56.0° / 102.0°</p> <p>Efficiency 84 %</p> <p>Peak intensity 0.8 cd/lm</p> <p>LEDs/each optic 1</p> <p>Light colour Tunable White</p> <p>Required components: C16142_HEKLA-SOCKET-K Bender Wirth: 491 Typ L8</p>		
<p></p> <p>LED Vesta DTW 15mm (33W)</p> <p>FWHM / FWTM 58.0° / 109.0°</p> <p>Efficiency 84 %</p> <p>Peak intensity 0.7 cd/lm</p> <p>LEDs/each optic 1</p> <p>Light colour White</p> <p>Required components: C16142_HEKLA-SOCKET-K Bender Wirth: 491 Typ L8</p>		

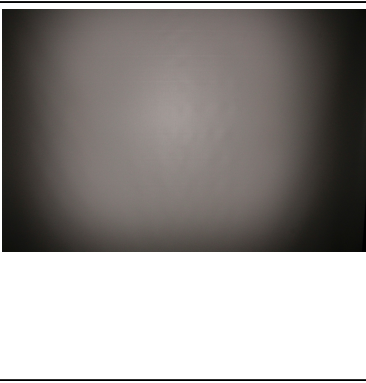
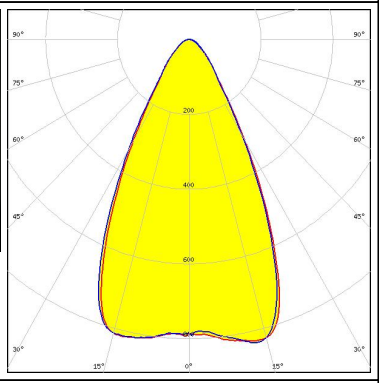
### OPTICAL RESULTS (MEASURED):

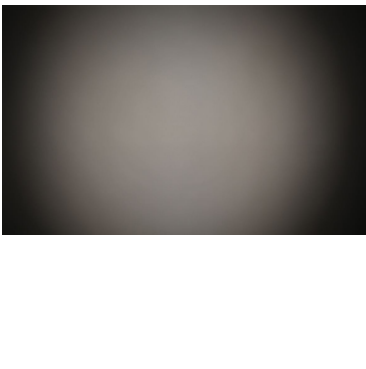
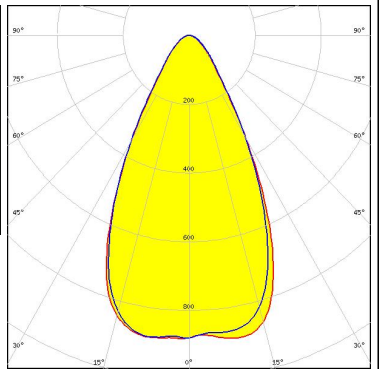
<p></p> <p>LED Vesta DTW 9mm (4W/6W/12W)            FWHM / FWTM 55.0° / 90.0°            Efficiency 87 %            Peak intensity 0.9 cd/lm            LEDs/each optic 1            Light colour White            Required components:            C16142_HEKLA-SOCKET-K            Bender Wirth: 490 Typ L8</p>		
<p></p> <p>LED Vesta TW 13mm (25W) CSP            FWHM / FWTM 56.0° / 102.0°            Efficiency 85 %            Peak intensity 0.8 cd/lm            LEDs/each optic 1            Light colour White            Required components:            C16142_HEKLA-SOCKET-K            Bender Wirth: 492 Typ L8</p>		
<p></p> <p>LED Vesta TW 6mm DP            FWHM / FWTM 55.0° / 90.0°            Efficiency 85 %            Peak intensity 0.9 cd/lm            LEDs/each optic 1            Light colour White            Required components:            C16142_HEKLA-SOCKET-K            Bender Wirth: 504 Typ L8</p>		
<p></p> <p>LED Vesta TW 9mm (12W) CSP            FWHM / FWTM 55.0° / 90.0 + 92.0°            Efficiency 87 %            Peak intensity 0.9 cd/lm            LEDs/each optic 1            Light colour White            Required components:            C16142_HEKLA-SOCKET-K</p>		

### OPTICAL RESULTS (MEASURED):

#### CITIZEN

LED CLC020 Series (Dim-To-Warm)  
 FWHM / FWTM 53.0° / 89.0 + 85.0°  
 Efficiency 86 %  
 Peak intensity 1 cd/lm  
 LEDs/each optic 1  
 Light colour White  
 Required components:  
 C16142\_HEKLA-SOCKET-K

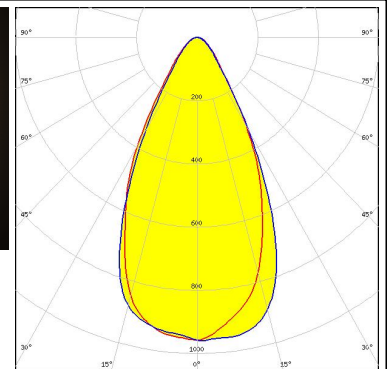
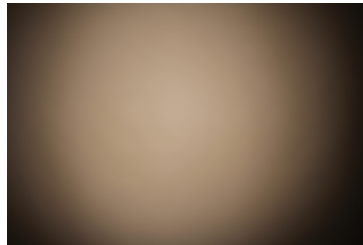

#### CITIZEN

LED CLL02x/CLU02x (LES10)  
 FWHM / FWTM 58.0° / 95.0 + 94.0°  
 Efficiency 89 %  
 Peak intensity 0.9 cd/lm  
 LEDs/each optic 1  
 Light colour White  
 Required components:  
 F15255\_HEKLA-SOCKET-C

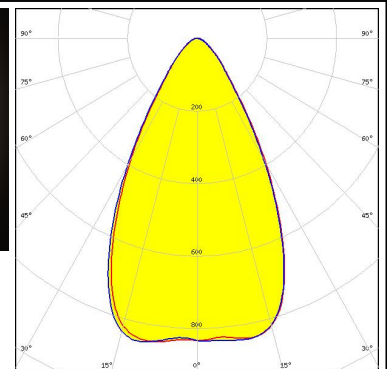
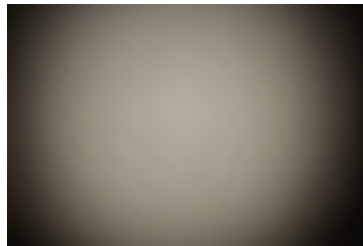

#### CITIZEN

LED CLU700/701/702/703  
 FWHM / FWTM 55.0 + 56.0° / 90.0°  
 Efficiency 90 %  
 Peak intensity 0.9 cd/lm  
 LEDs/each optic 1  
 Light colour White  
 Required components:  
 F15255\_HEKLA-SOCKET-C

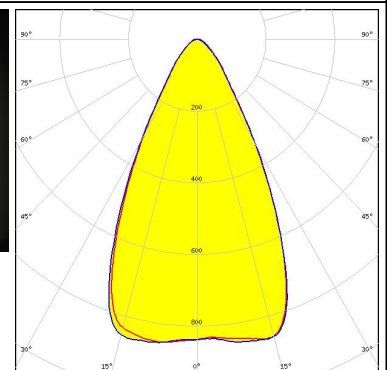

#### CITIZEN

LED CLU7A2/7A3  
 FWHM / FWTM 55.0° / 91.0°  
 Efficiency 90 %  
 Peak intensity 0.9 cd/lm  
 LEDs/each optic 1  
 Light colour White  
 Required components:  
 F15255\_HEKLA-SOCKET-C

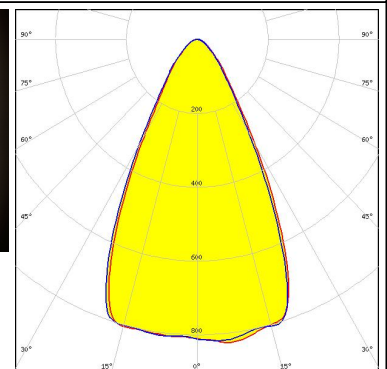
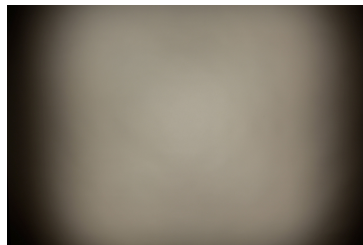

#### OPTICAL RESULTS (MEASURED):

#### CITIZEN

LED LCN-C01B (Tunable White)  
 FWHM / FWTM 54.0° / 92.0°  
 Efficiency 86 %  
 Peak intensity 0.9 cd/lm  
 LEDs/each optic 1  
 Light colour White  
 Required components:  
 C16142\_HEKLA-SOCKET-K  
 Bender Wirth: 481 Typ L8

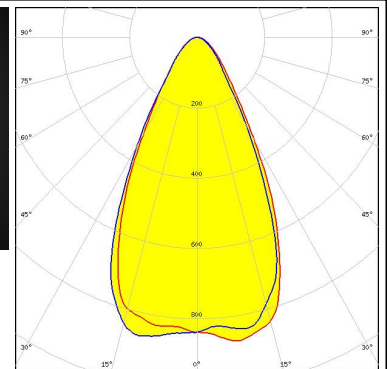
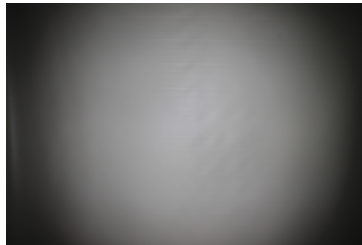

#### CREE LED

LED CMA1516  
 FWHM / FWTM 61.0° / 100.0°  
 Efficiency 92 %  
 Peak intensity 0.8 cd/lm  
 LEDs/each optic 1  
 Light colour White  
 Required components:  
 F15256\_HEKLA-SOCKET-D

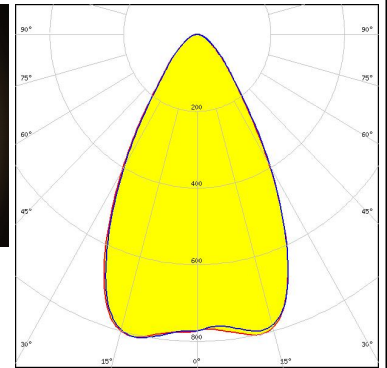
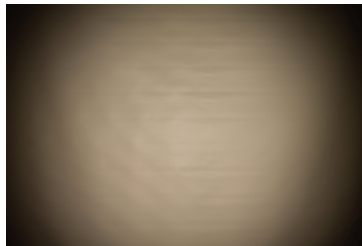

#### CREE LED

LED CMA1825  
 FWHM / FWTM 59.0° / 101.0°  
 Efficiency 90 %  
 Peak intensity 0.8 cd/lm  
 LEDs/each optic 1  
 Light colour White  
 Required components:  
 F15254\_HEKLA-SOCKET-B

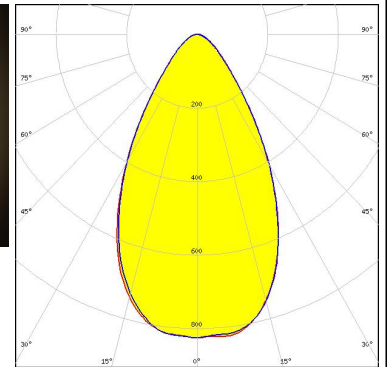
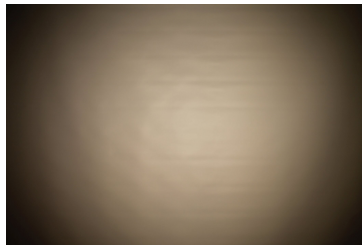

#### CREE LED

LED CMT14xx  
 FWHM / FWTM 58.0° / 97.0°  
 Efficiency 91 %  
 Peak intensity 0.9 cd/lm  
 LEDs/each optic 1  
 Light colour White  
 Required components:  
 F15255\_HEKLA-SOCKET-C  
 F15176\_ANGELETTE-LENS

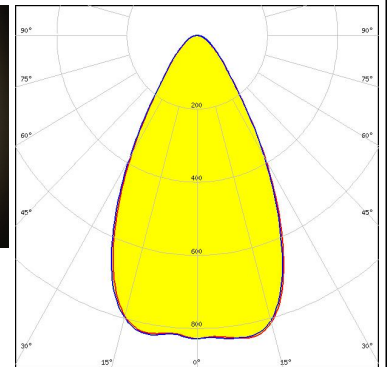



### OPTICAL RESULTS (MEASURED):

#### CREE LED

LED CMT19xx  
 FWHM / FWTM 58.0° / 108.0°  
 Efficiency 88 %  
 Peak intensity 0.8 cd/lm  
 LEDs/each optic 1  
 Light colour White  
 Required components:  
 F15859\_HEKLA-SOCKET-I

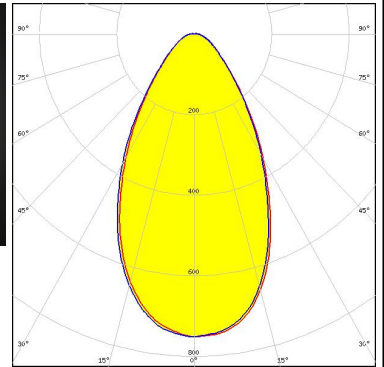

#### CREE LED

LED CXA/B 13xx  
 FWHM / FWTM 57.0° / 92.0°  
 Efficiency 91 %  
 Peak intensity 0.9 cd/lm  
 LEDs/each optic 1  
 Light colour White  
 Required components:  
 F15956\_HEKLA-SOCKET-J

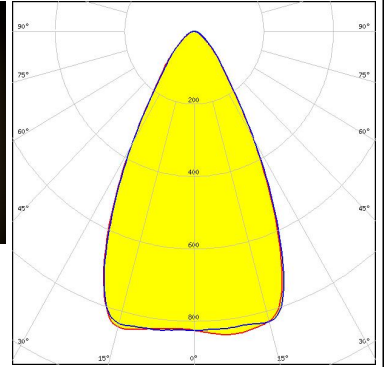

#### CREE LED

LED CXA/B 15xx  
 FWHM / FWTM 59.0° / 95.0°  
 Efficiency 91 %  
 Peak intensity 0.9 cd/lm  
 LEDs/each optic 1  
 Light colour White  
 Required components:  
 F15256\_HEKLA-SOCKET-D

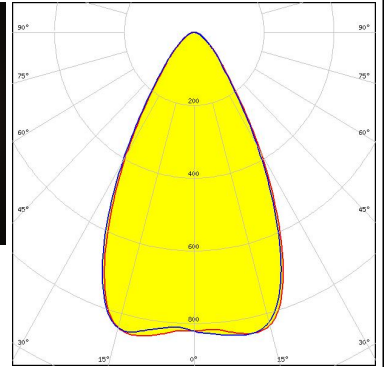
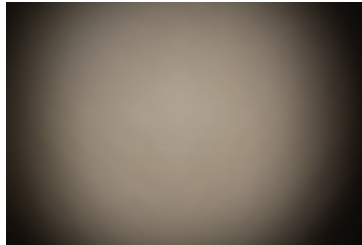

#### LUMILEDS

LED LUXEON CX Plus CoB L08 (Gen2)  
 FWHM / FWTM 57.0° / 107.0°  
 Efficiency 90 %  
 Peak intensity 0.8 cd/lm  
 LEDs/each optic 1  
 Light colour White  
 Required components:  
 Bender Wirth: 637a Hekla

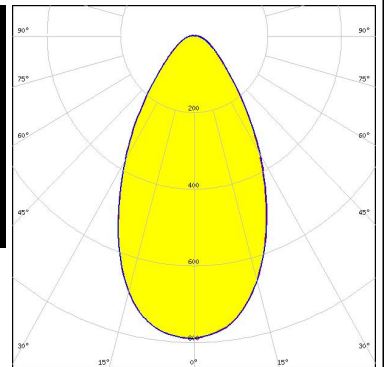
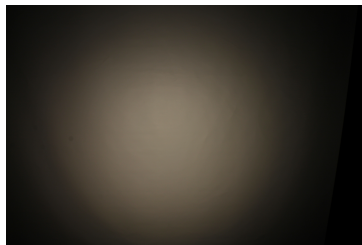

### OPTICAL RESULTS (MEASURED):

#### LUMILEDS

LED LUXEON CoB 1202HD  
 FWHM / FWTM 57.0 + 55.0° / 94.0 + 92.0°  
 Efficiency 90 %  
 Peak intensity 0.9 cd/m  
 LEDs/each optic 1  
 Light colour White  
 Required components:  
 F15848\_HEKLA-SOCKET-G

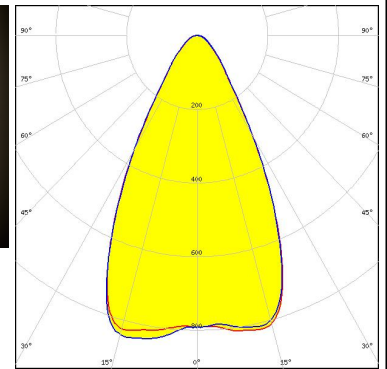

#### LUMILEDS

LED LUXEON CoB 1202s  
 FWHM / FWTM 57.0° / 83.0 + 93.0°  
 Efficiency 91 %  
 Peak intensity 0.9 cd/m  
 LEDs/each optic 1  
 Light colour White  
 Required components:  
 F15848\_HEKLA-SOCKET-G

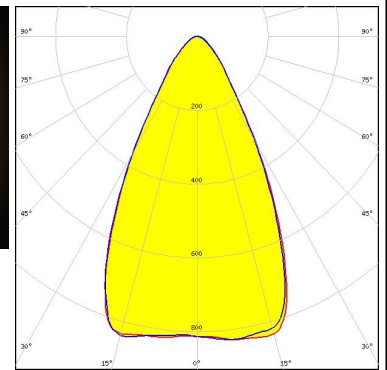
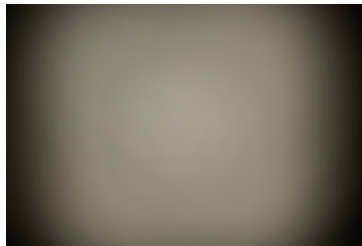

#### LUMILEDS

LED LUXEON CoB 1204HD  
 FWHM / FWTM 57.3 + 57.5° / 96.0 + 97.0°  
 Efficiency 90 %  
 Peak intensity 0.8 cd/m  
 LEDs/each optic 1  
 Light colour White  
 Required components:  
 F15858\_HEKLA-SOCKET-H

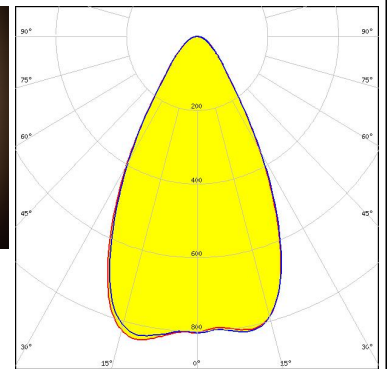
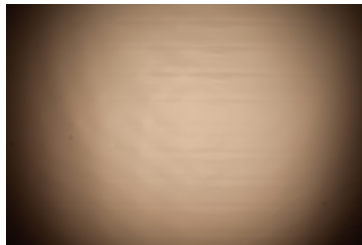



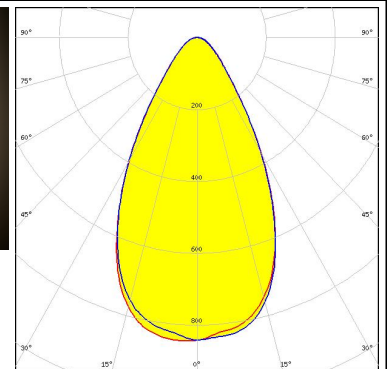
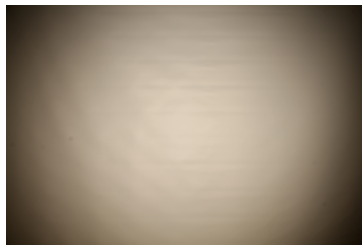

#### LUMILEDS

LED LUXEON CoB 1205HD  
 FWHM / FWTM 57.3 + 57.4° / 98.4 + 98.2°  
 Efficiency 89 %  
 Peak intensity 0.8 cd/m  
 LEDs/each optic 1  
 Light colour White  
 Required components:  
 F15858\_HEKLA-SOCKET-H

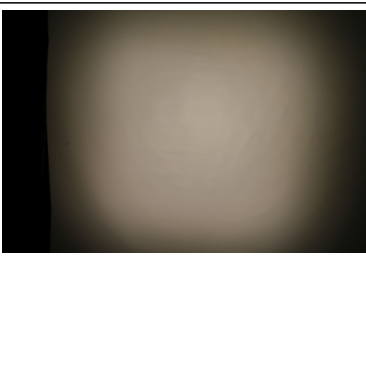
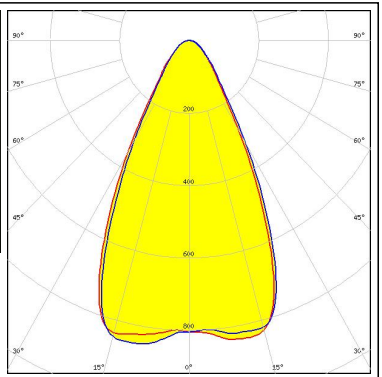

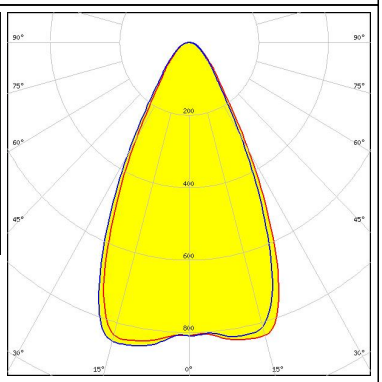
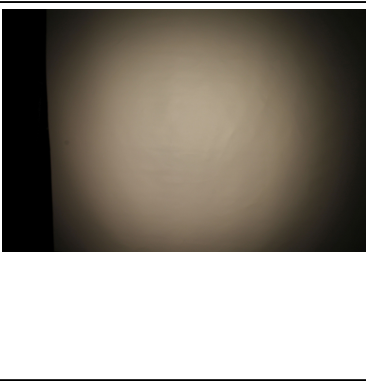
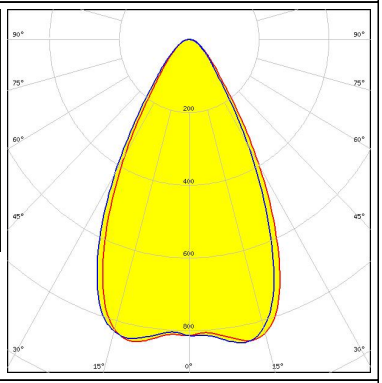
#### OPTICAL RESULTS (MEASURED):

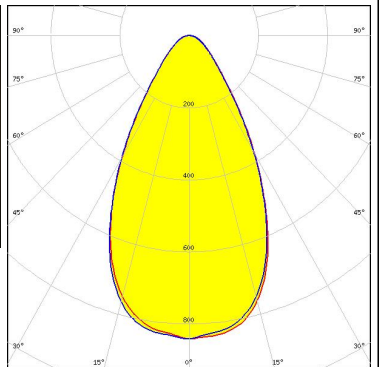
<p><b>LUMILEDS</b></p> <p>LED LUXEON CX Plus CoB - HD S01H4</p> <p>FWHM / FWTM 55.0° / 92.0°</p> <p>Efficiency 91 %</p> <p>Peak intensity 0.9 cd/m</p> <p>LEDs/each optic 1</p> <p>Light colour White</p> <p>Required components: Bender Wirth: 634c Hekla</p>		
<p><b>LUMILEDS</b></p> <p>LED LUXEON CX Plus CoB - HD S01H6 / HD S02H6</p> <p>FWHM / FWTM 55.0° / 93.0°</p> <p>Efficiency 91 %</p> <p>Peak intensity 0.9 cd/m</p> <p>LEDs/each optic 1</p> <p>Light colour White</p> <p>Required components: Bender Wirth: 634c Hekla</p>		
<p><b>LUMILEDS</b></p> <p>LED LUXEON CX Plus CoB - HD S04H9</p> <p>FWHM / FWTM 58.0° / 95.0°</p> <p>Efficiency 91 %</p> <p>Peak intensity 0.8 cd/m</p> <p>LEDs/each optic 1</p> <p>Light colour White</p> <p>Required components: Bender Wirth: 634c Hekla</p>		
<p><b>LUMILEDS</b></p> <p>LED LUXEON CX Plus CoB L04 / L05 (Gen2)</p> <p>FWHM / FWTM 57.0° / 100.0°</p> <p>Efficiency 90 %</p> <p>Peak intensity 0.8 cd/m</p> <p>LEDs/each optic 1</p> <p>Light colour White</p> <p>Required components: Bender Wirth: 637a Hekla</p>		

#### OPTICAL RESULTS (MEASURED):

#### LUMILEDS

LED LUXEON CX Plus CoB M02 / M03 (Gen2)  
 FWHM / FWTM 57.0° / 95.0°  
 Efficiency 91 %  
 Peak intensity 0.8 cd/lm  
 LEDs/each optic 1  
 Light colour White  
 Required components:  
 Bender Wirth: 641a Hekla

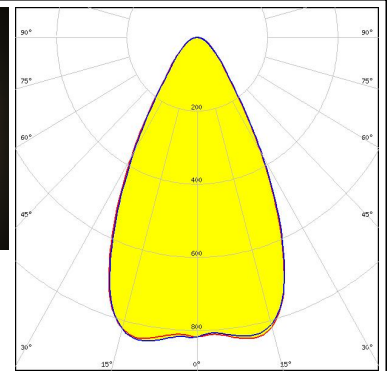

#### LUMILEDS

LED LUXEON CX Plus CoB S01 (Gen2)  
 FWHM / FWTM 55.0° / 92.0°  
 Efficiency 91 %  
 Peak intensity 0.9 cd/lm  
 LEDs/each optic 1  
 Light colour White  
 Required components:  
 Bender Wirth: 634c Hekla

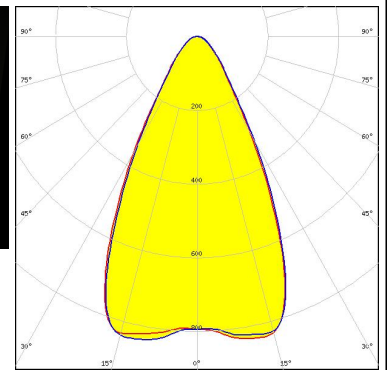
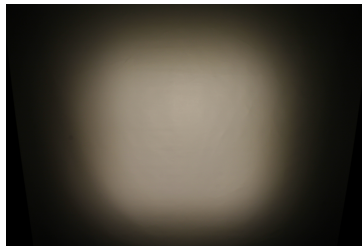

#### LUMINUS

LED CDM-14 (Dim-To-Warm)  
 FWHM / FWTM 56.0° / 102.0°  
 Efficiency 82 %  
 Peak intensity 0.8 cd/lm  
 LEDs/each optic 1  
 Light colour White  
 Required components:  
 C16142\_HEKLA-SOCKET-K  
 Bender Wirth: 491 Typ L8

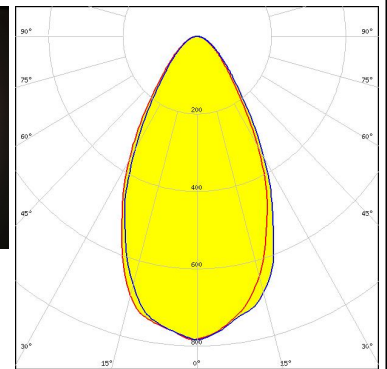
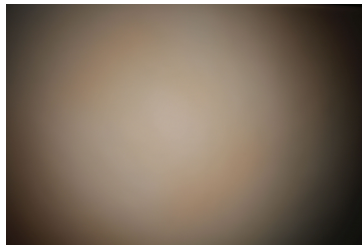



#### LUMINUS

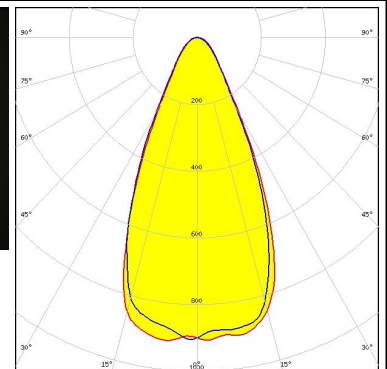
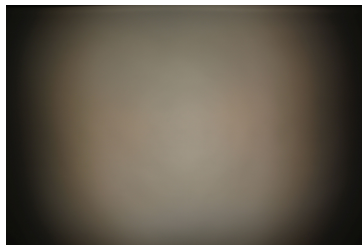

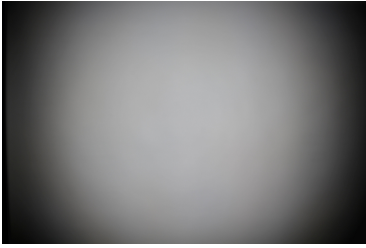
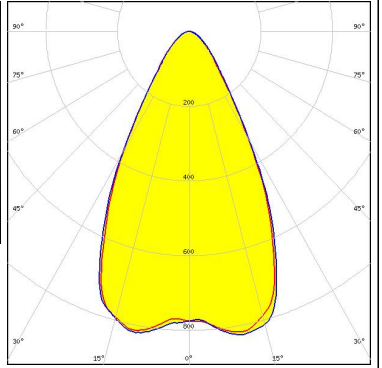
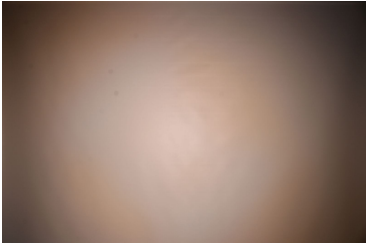
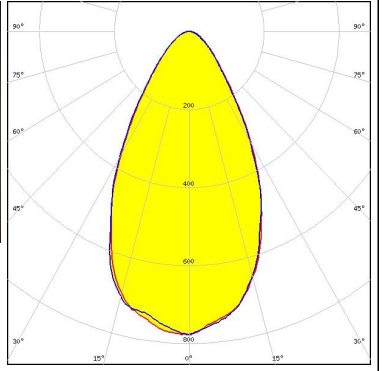
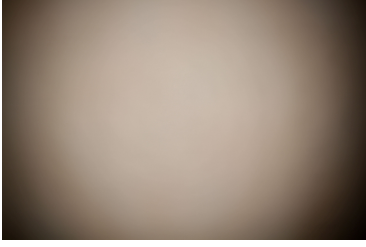
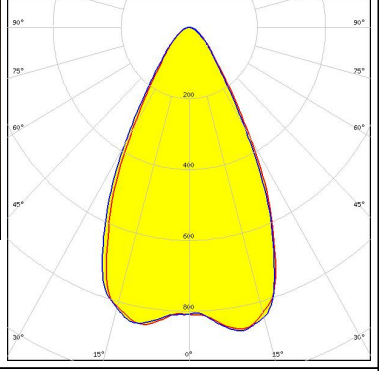

LED CDM-6 (Dim-To-Warm)  
 FWHM / FWTM 49.0° / 85.0°  
 Efficiency 82 %  
 Peak intensity 0.9 cd/lm  
 LEDs/each optic 1  
 Light colour White  
 Required components:  
 C16142\_HEKLA-SOCKET-K  
 Bender Wirth: 490 Typ L8

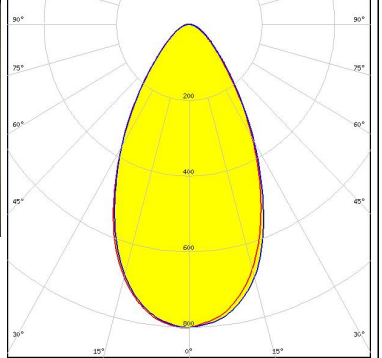

### OPTICAL RESULTS (MEASURED):

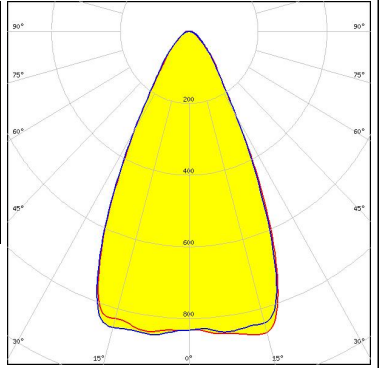
<p><b>LUMINUS</b></p> <p>LED CDM-9 (Dim-To-Warm)</p> <p>FWHM / FWTM 58.0° / 96.0°</p> <p>Efficiency 86 %</p> <p>Peak intensity 0.8 cd/lm</p> <p>LEDs/each optic 1</p> <p>Light colour White</p> <p>Required components: C16142_HEKLA-SOCKET-K Bender Wirth: 490 Typ L8</p>		
<p><b>LUMINUS</b></p> <p>LED CTM-14 (Tunable White)</p> <p>FWHM / FWTM 57.0° / 102.0°</p> <p>Efficiency 82 %</p> <p>Peak intensity 0.8 cd/lm</p> <p>LEDs/each optic 1</p> <p>Light colour White</p> <p>Required components: C16142_HEKLA-SOCKET-K Bender Wirth: 442 Typ L8</p>		
<p><b>LUMINUS</b></p> <p>LED CTM-9 (Tunable White)</p> <p>FWHM / FWTM 56.0° / 91.0°</p> <p>Efficiency 86 %</p> <p>Peak intensity 0.9 cd/lm</p> <p>LEDs/each optic 1</p> <p>Light colour White</p> <p>Required components: C16142_HEKLA-SOCKET-K Bender Wirth: 495 Typ L8</p>		
<p><b>LUMINUS</b></p> <p>LED CxM-14 (19x19)</p> <p>FWHM / FWTM 57.0° / 103.0°</p> <p>Efficiency 86 %</p> <p>Peak intensity 0.8 cd/lm</p> <p>LEDs/each optic 1</p> <p>Light colour White</p> <p>Required components: F15859_HEKLA-SOCKET-I</p>		

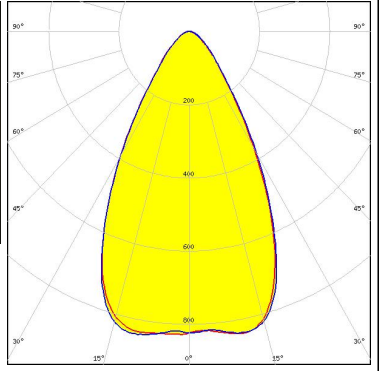
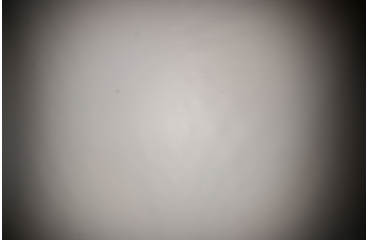
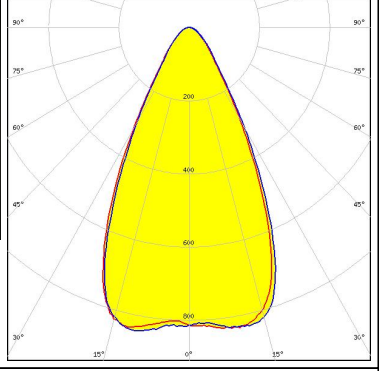
### OPTICAL RESULTS (MEASURED):

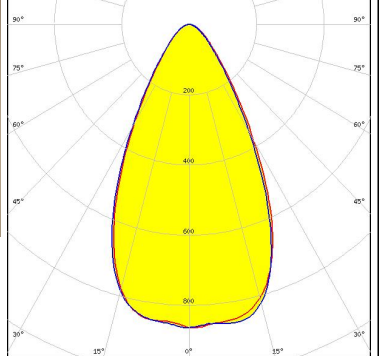
<p><b>LUMINUS</b></p> <p>LED CXM-4            FWHM / FWTM 54.0° / 88.0°            Efficiency 90 %            Peak intensity 1 cd/lm            LEDs/each optic 1            Light colour White            Required components:            F15255_HEKLA-SOCKET-C</p>		
<p><b>LUMINUS</b></p> <p>LED CxM-9 (13.5x13.5)            FWHM / FWTM 58.0° / 95.0°            Efficiency 89 %            Peak intensity 0.9 cd/lm            LEDs/each optic 1            Light colour White            Required components:            F15255_HEKLA-SOCKET-C</p>		
<p><b>NICHIA</b></p> <p>LED NJCWL024Z-V1MT: COB L-Type Tunable White            FWHM / FWTM 56.0° / 89.0°            Efficiency 83 %            Peak intensity 0.9 cd/lm            LEDs/each optic 1            Light colour White            Required components:            C16142_HEKLA-SOCKET-K            Bender Wirth: 497 Typ L8</p>		
<p><b>NICHIA</b></p> <p>LED NVCWJ024Z-V1MT: COB J-Type Tunable White            FWHM / FWTM 55.0° / 94.0 + 49.0°            Efficiency 86 %            Peak intensity 0.9 cd/lm            LEDs/each optic 1            Light colour White            Required components:            C16142_HEKLA-SOCKET-K            Bender Wirth: 498 Typ L8</p>		

### OPTICAL RESULTS (MEASURED):

#### SAMSUNG

LED LC003D / LC006D / LC009D / LC013D  
 FWHM / FWTM 58.0° / 95.0 + 96.0°  
 Efficiency 90 %  
 Peak intensity 0.9 cd/m  
 LEDs/each optic 1  
 Light colour White  
 Required components:  
 F15255\_HEKLA-SOCKET-C

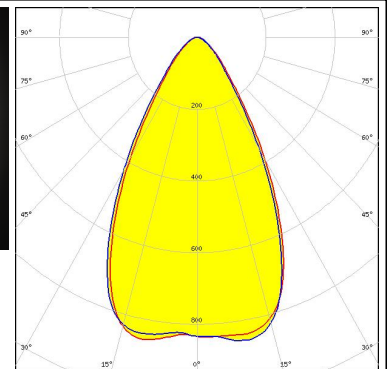
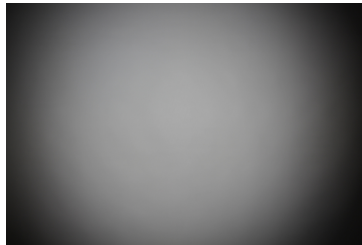

#### SAMSUNG

LED LC010C  
 FWHM / FWTM 58.0° / 95.0 + 96.0°  
 Efficiency 90 %  
 Peak intensity 0.9 cd/m  
 LEDs/each optic 1  
 Light colour White  
 Required components:  
 F15848\_HEKLA-SOCKET-G

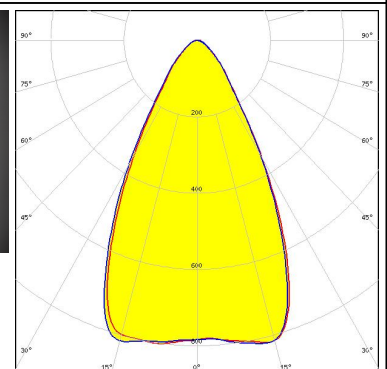
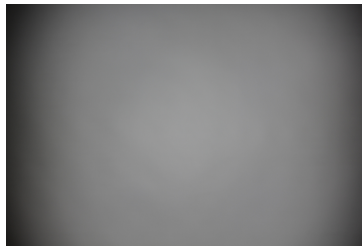

#### SAMSUNG

LED LC010C G2  
 FWHM / FWTM 55.0° / 91.0°  
 Efficiency 89 %  
 Peak intensity 0.9 cd/m  
 LEDs/each optic 1  
 Light colour White  
 Required components:  
 F15255\_HEKLA-SOCKET-C

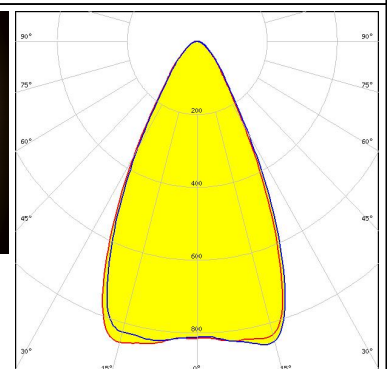
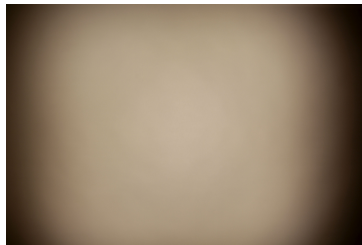

#### SAMSUNG

LED LC010T (Tunable White)  
 FWHM / FWTM 55.0° / 92.0°  
 Efficiency 87 %  
 Peak intensity 0.9 cd/m  
 LEDs/each optic 1  
 Light colour Tunable White  
 Required components:  
 C16142\_HEKLA-SOCKET-K  
 Bender Wirth: 501 Typ L8

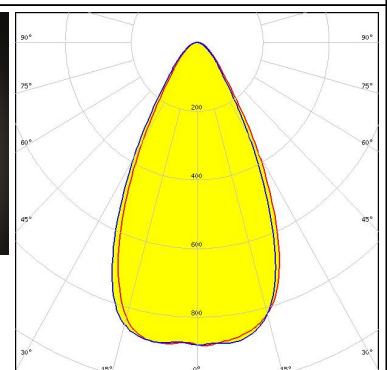
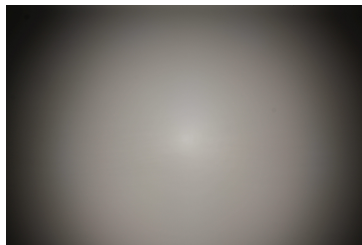

### OPTICAL RESULTS (MEASURED):

#### SAMSUNG

LED LC016D / LC019D / LC026D / LC033D  
 FWHM / FWTM 59.0 + 58.0° / 107.0°  
 Efficiency 86 %  
 Peak intensity 0.8 cd/m  
 LEDs/each optic 1  
 Light colour White  
 Required components:  
 F15859\_HEKLA-SOCKET-I

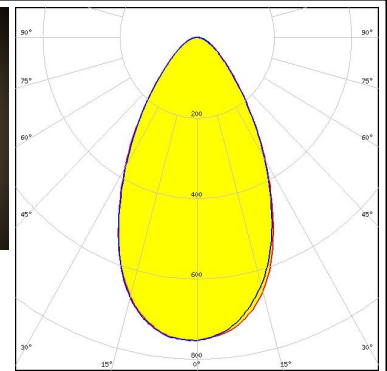
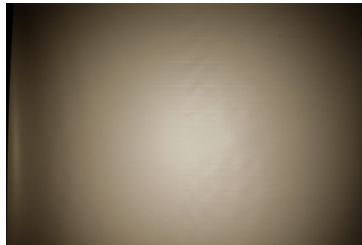

#### SAMSUNG

LED LC020C  
 FWHM / FWTM 59.0° / 97.0°  
 Efficiency 90 %  
 Peak intensity 0.8 cd/m  
 LEDs/each optic 1  
 Light colour White  
 Required components:  
 F15848\_HEKLA-SOCKET-G

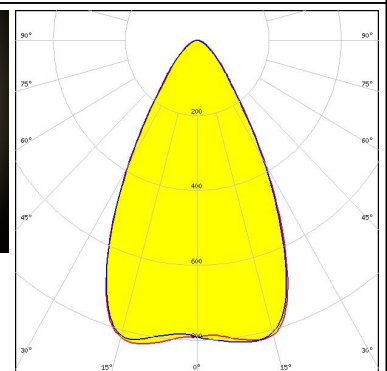
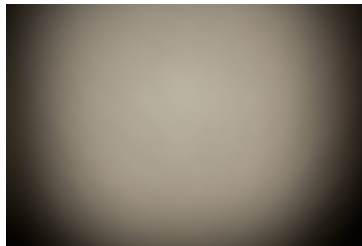

#### SAMSUNG

LED LC020C G2  
 FWHM / FWTM 58.0° / 95.0°  
 Efficiency 88 %  
 Peak intensity 0.8 cd/m  
 LEDs/each optic 1  
 Light colour White  
 Required components:  
 F15859\_HEKLA-SOCKET-I

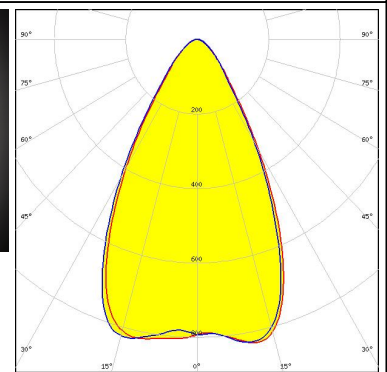
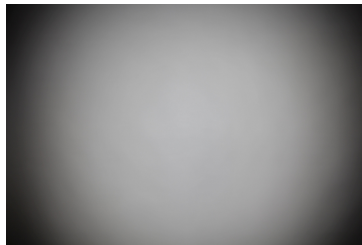

#### SAMSUNG

LED LC020T (Tunable white)  
 FWHM / FWTM 55.0° / 99.0°  
 Efficiency 86 %  
 Peak intensity 0.9 cd/m  
 LEDs/each optic 1  
 Light colour Tunable White  
 Required components:  
 C16142\_HEKLA-SOCKET-K  
 Bender Wirth: 501 Typ L8

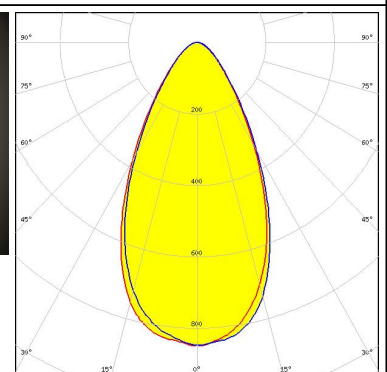
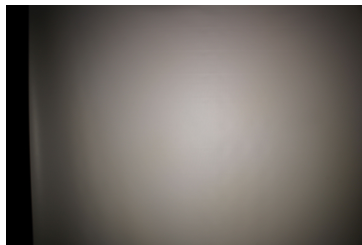



#### OPTICAL RESULTS (MEASURED):

#### TRIDONIC

LED SLE G7 LES09  
 FWHM / FWTM 58.0° / 92.0°  
 Efficiency 90 %  
 Peak intensity 0.9 cd/lm  
 LEDs/each optic 1  
 Light colour White  
 Required components:  
 F15255\_HEKLA-SOCKET-C

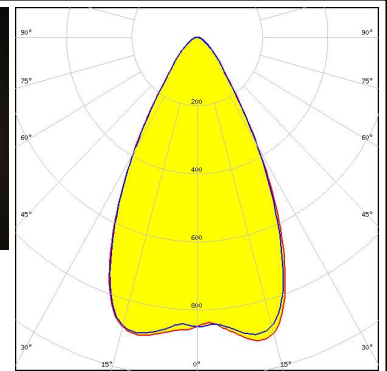
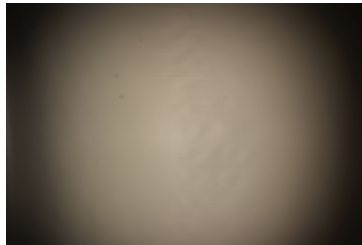

#### TRIDONIC

LED SLE G7 LES13  
 FWHM / FWTM 57.0° / 99.0°  
 Efficiency 87 %  
 Peak intensity 0.8 cd/lm  
 LEDs/each optic 1  
 Light colour White  
 Required components:  
 F15859\_HEKLA-SOCKET-I

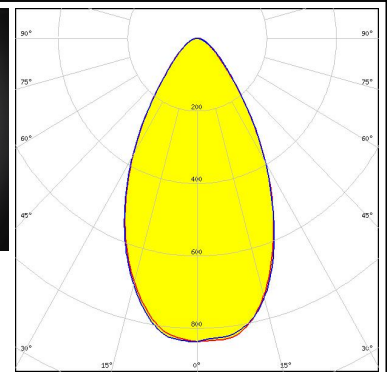
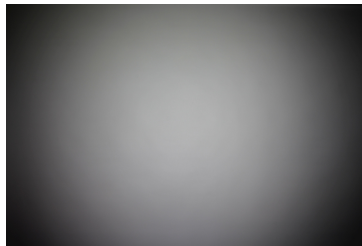

#### TRIDONIC

LED SLE G7 LES15  
 FWHM / FWTM 58.0° / 106.0°  
 Efficiency 87 %  
 Peak intensity 0.8 cd/lm  
 LEDs/each optic 1  
 Light colour White  
 Required components:  
 F15859\_HEKLA-SOCKET-I

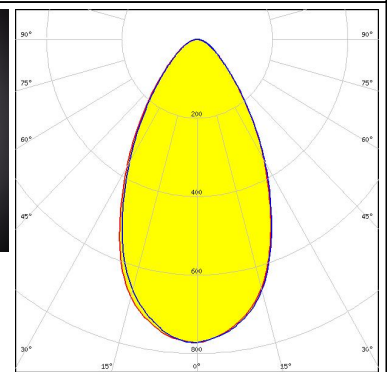
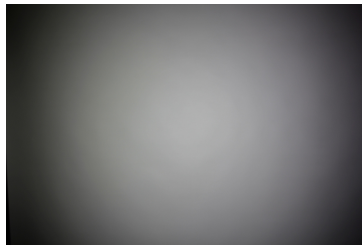

#### XICATO

LED XOB 14.5 mm  
 FWHM / FWTM 57.0° / 104.0°  
 Efficiency 87 %  
 Peak intensity 0.8 cd/lm  
 LEDs/each optic 1  
 Light colour White  
 Required components:  
 F15859\_HEKLA-SOCKET-I

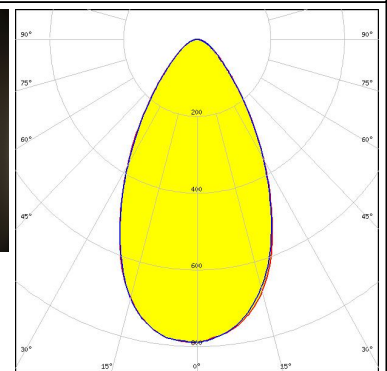
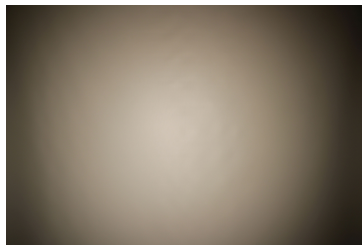

### OPTICAL RESULTS (MEASURED):

#### XICATO

LED XOB 9.8 mm  
FWHM / FWTM 58.0° / 94.0°  
Efficiency 90 %  
Peak intensity 0.9 cd/lm  
LEDs/each optic 1  
Light colour White  
Required components:  
F15255\_HEKLA-SOCKET-C

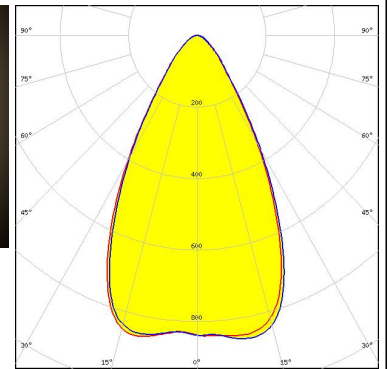

#### XICATO

LED XTM - 19mm LES  
FWHM / FWTM 62.0° / 115.0°  
Efficiency 86 %  
Peak intensity 0.7 cd/lm  
LEDs/each optic 1  
Light colour White  
Required components:  
C16058\_XTM-ADAPTER-50-C

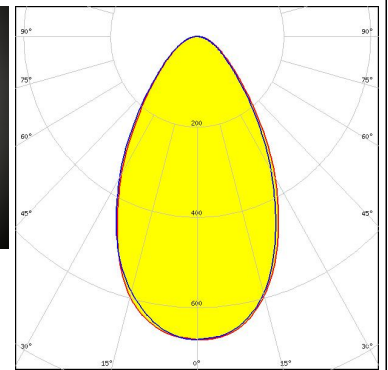

### OPTICAL RESULTS (SIMULATED):



LED COB T-Type  
FWHM / FWTM 54.0° / 81.0°  
Efficiency 86 %  
Peak intensity 1 cd/lm  
LEDs/each optic 1  
Light colour White  
Required components:  
F15848\_HEKLA-SOCKET-G

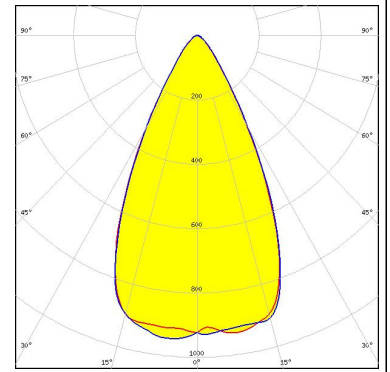

### GENERAL INFORMATION:

NOTE: The typical beam angle will be changed by different color, chip size and chip position tolerance. The typical total beam angle is the full angle measured where the luminous intensity is half of the peak value.

Due to use of high power COB's with this product, special attention to proper thermal design is highly recommended. LEDiL has no liability for direct, indirect or consecutive damages arising from the LEDiL products being used outside of the recommended temperature range.

### MATERIALS:

As part of our continuous research and improvement processes, and to ensure the best possible quality and availability of our products, LEDiL reserves the right to change material grades without notice.

### PRODUCT DATA USER AGREEMENT AND DISCLAIMER:

The measured data in the provided downloadable LEDiL Product Datasheets and Mechanical 2D-Drawings is rounded and provided as reference for planning. LEDiL Oy's optical specifications have been verified by conducting performance testing of the products in accordance with the company's quality system. The reported data are averaged results of multiple measurements with typical variation. LEDiL Oy reserves the right to without prior notification make changes and improvements to its products.

LEDiL Oy assumes neither warranty, nor guarantee nor any other liability of any kind for the contents and correctness of the provided data. The provided data has been generated with highest diligence but the provided data may in reality not represent the complete possible variation range of all intrinsic parameters. Therefore, in certain cases a deviation from the provided data could occur.

LEDiL Oy reserves the right to undertake technical changes of its products without further notification which could lead to changes in the provided data. LEDiL Oy assumes no liability of any kind for the possible deviation from any provided data or any other damage resulting from the usage of the provided data.

The user agrees to this disclaimer and user agreement with the download or usage of the provided files.

#### LEDiL Oy

Joensuunkatu 13  
FI-24240 SALO  
Finland

#### LEDiL Inc.

228 West Page Street  
Suite D  
Sycamore IL 60178  
USA

#### Ledil Optics Technology (Shenzhen) Co., Ltd.

# 405 , Block B  
Casic Motor Building  
Shenzhen 518057  
P.R.CHINA

#### Local sales and technical support

[www.ledil.com/  
where\\_to\\_buy](http://www.ledil.com/where_to_buy)

#### Shipping locations

Salo, Finland  
Hong Kong, China

#### Distribution Partners

[www.ledil.com/  
where\\_to\\_buy](http://www.ledil.com/where_to_buy)