



ACL-750

DATA LOGGING WRIST AND FOOT STRAP COMBO TESTER KIT

OWNERS MANUAL & OPERATION GUIDE

Includes software, calibration data, bar code,
magnetic stripe and proximity card reader instructions



MANUAL PRICE: \$25.00 US
SOFTWARE VERSION: _____
SERIAL NUMBER: _____
COMPANY: _____

ACL Staticide
840 West 49th Place
Chicago, IL 60609 USA
Tel: 800.782.8420 or 847.981.9212
FAX: 847.981.9278
Email: info@aclstaticide.com
www.aclstaticide.com



TABLE OF CONTENTS

INTRODUCTION.....	4
FEATURES:.....	5
CALIBRATION VERIFICATION	6
ISO TRAINING AND CERTIFICATION OF ESD HANDLING AND CONTROL MEASURES FOR OPERATORS	7
Objectives	7
Qualification and Certification Testing	7
Standards Compliant	7
Learning station system requirements	7
Setup of training courses	7
Training Program Sequence of Events	8
TESTING OF WRIST STRAPS AND FOOTWEAR	9
BASIC SETUP	10
EQUIPMENT	10
Equipment Required	10
Equipment Provided.....	10
Equipment Options	10
HARDWARE INSTALLATION	11
Before You Begin.....	11
Meter Assembly	11
Meter Adjustments	12
Dip Switch Settings for 100M unit	13
Dip Switch Settings for 1000M unit special unit.....	14
Door Relay	15
SOFTWARE INSTALLATION GUIDE	18
Software Installation for First Time Installation of New Software.....	18
Software installation for Upgrading to a Minor Version Change	18
Software Installation for Upgrading to a Major Version Change	18
STARTING THE PROGRAM	19
Help.....	20
CARD READER INSTALLATION INSTRUCTIONS.....	21
Keyboard Wedge and USB Bar Code Reader or Magnetic Stripe Reader Installation.....	22
Trouble Shooting if Scanner Does Not Read Correctly	23
USB Reader Installation.....	24
Trouble Shooting if USB scanner Does Not Read Correctly.....	24
General RS232 Reader Installation	25
Trouble Shooting If the RS232 reader card does not work.....	26
CASI-RUSCO™ 94x, 97x weigand, HID 5352, HID RW-400™, AWID™ SP-6820 RS232 reader Installation.....	27
Trouble Shooting If the card does not work.	27
PROGRAM SETTINGS.....	29
General Configuration	29
Change Administrator Password	31
Unknown ID Configuration'	31
User Information	32
Directories.....	34
Change Employee Password.....	34
Certification Configuration.....	35
Remote Data Base Setup for accessing employee names.....	35
Remote Data Base Setup for storing resistance test data	39
Multiple Station Configuration and operation	41
Language Display	43

OPERATION	44
OPERATOR TESTING INSTRUCTIONS WHEN NOT USING THE COMPUTER	44
OPERATOR TESTING INSTRUCTIONS WHEN USING THE COMPUTER.....	45
Troubleshooting high wrist readings:	45
Troubleshooting low wrist readings:.....	45
Troubleshooting high foot readings:.....	45
Troubleshooting low foot readings:	45
Example of program waiting for the test button to be pressed:.....	46
Example of a good reading:	46
Example of a low wrist reading:	47
Example of a high wrist reading:.....	47
Example of a multiple high readings:	48
Example of a miscommunication reading caused by releasing the test button prematurely:	48
REPORT GENERATION:	49
Monthly report	49
Entire Log report	50
Daily report.....	50
Individual test log report.....	50
Exceptions report	51
Twice Tested Exceptions report.....	52
Certification Expiration report.....	53
Individual Attendance report	53
Monthly Vacation (Attendance) report	53
Automatic Emailed Reports	54
LogSort Notes	58
TOOLS.....	59
ADVANCED FEATURE SETUP	61
NETWORKING THE ACL-750 TESTER.....	61
Test Station Computer Setup.....	63
Server Computer Setup	63
Synchronizing Test Station System Time	63
EsdTest File Administration	64
INTERFACING WITH OTHER DATA BASES.....	65
Importing Log files to Excel:.....	65
Exporting Name.txt file from Excel:	65
Importing Files To Microsoft Access:	66
Exporting the Names.txt File From Microsoft Access:	66
Reading the Employee Names Directly From the Company Data base	66
SPECIFICATIONS:	67
MAINTENANCE AND CALIBRATION	68
MAINTENANCE.....	68
CALIBRATION TESTING	68
TROUBLESHOOTING AND FREQUENTLY ASKED QUESTIONS (FAQ).....	69
WARANTEE AND LICENSE AGREEMENTS	76
LIMITED WARANTEE:	76
Exclusions.....	76
Limitations:.....	76
SOFTWARE LICENSE AGREEMENT;	76

INTRODUCTION

Congratulations on purchasing your new ACL-750 data-logging wrist and foot strap testing kit!

This is the finest tester available on the market.

The ACL-750 combo meter is an instrument that concurrently measures the resistance of a wrist strap and two foot straps within a few second period. The measurements are sent to a computer and can be judged for valid readings, and then logged to a file. Many additional services are available as shown in the following "features" section, such as having reports directly emailed to supervisors.

A typical test station consists of a badge reader to identify the user, the ACL-750, a computer, and a monitor. The user scans his badge and tests his straps. Multiple test stations are connected via an Ethernet network to a common server that combines the data and issues reports.

For economy, multiple meters may be connected to one computer, but the user loses the ability to see the direct readings on the monitor, and instead relies on the visual LED indicators on the meter.

The RS232 output allows many connection options:

- Direct connection of one meter to a computer RS232 port (standard method)
- Connection to a computer USB port via an inexpensive RS232 to USB converter
- Connection of multiple readers to a single computer with our serial multi-port card option
- Connection of multiple readers to a single computer with our RS232 to Ethernet converter option
- Connection of multiple readers to a single computer with our RS232 to wireless LAN converter option

Dual RS232 to Ethernet configuration

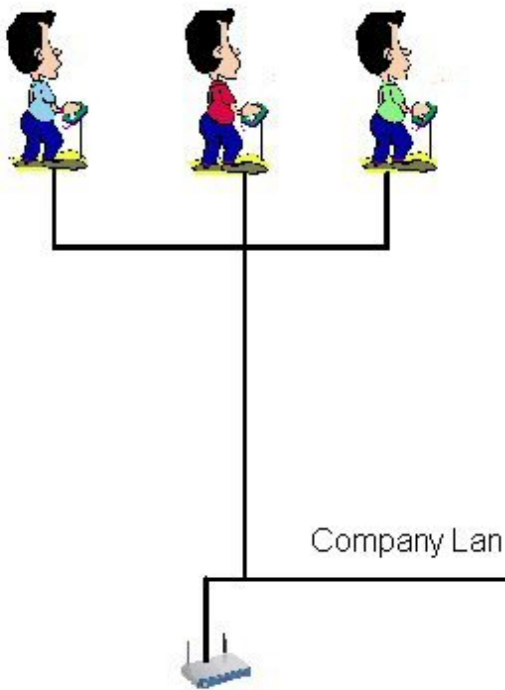

Dual RS232 configuration

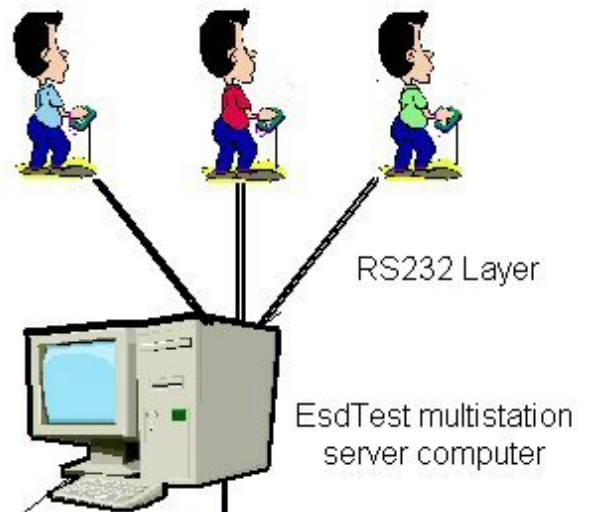

**Single computer
all mode multistation
EsdTest system configuration**

FEATURES:

- Reads actual resistance of the strap from 100 kilohms to 100 megohms and up to 1000megohms for new 1000M unit.
- Alarm points may be programmed to any value for any user or the combo tester limits can be automatically used.
- Accepts up to 30,000 employees
- Easy to use: employees step on the foot pads, plug in their wrist strap, scan a proximity card or barcode
 - (or click on their name)
 - (or type in the first few letters of their name)
 - (or type the line number of their name)
 - (or type their ID number)and push a button
- Generates and prints
 - monthly test results reports
 - daily event logs
 - continuous event logs
 - event logs for any employee over any time span
 - employee failure exception reports
 - certification expiration report
 - certification training exam report
 - attendance summary
 - vacation summary
 - labels for employees that pass the esd test
- Employee leave status(sick, vacation etc.) can be stored.
- Reports can be limited to specific work groups.
- Report files may be easily imported into other spreadsheets or data bases.
- Reports can be automatically generated and emailed.
- Requires a password to change the parameters and access the data.
- Can optionally require an individual password for each employee to test.
- Can read employee bar code badges or cards (via keyboard wedge).
 - Can use first, last, or middle n characters of the barcode.
 - Can ask employee to type in name if new badge is read.
- Can read employee proximity card with following readers:
 - HID 5352 or RW-400 RS232 reader.
 - Casi-Rusco 94x, 97x Wiegand reader
 - Motorola, Indala
 - Awid Sentinel-Prox SP-6820 reader
 - General RS-232 readers
- Can be used without a monitor.
- Is able to open a door if straps are in tolerance. As an accessory
- Is able to prevent unauthorized entry without the proper badge.
- Can warn employee of impending certification expiration.
- Can limit access of employees with expired certification.
- Runs on any Windows 98, ME, NT, 2000, or XP compatible PC.
- Uses any standard RS-232 communications port
 - Uses a standard dual DB9S (female) connector RS-232 cable
- Can use a USB port with a USB to fully compliant RS-232 port adapter.
- Can accept and display International dates and numbers
- Program window can be minimized only with correct password.
- Multiple stations can be connected to a network.
- A networked station will still operate even if the network malfunctions.
- Can read employees from a remote SQL data base.
- Can store test data to a remote SQL data base (Oracle, SQL2000, Access, etc).
- Optional certification training courses available.
- Reads training course data bases to determine which employees are certified.
- Can connect multiple stations to one computer.
- Can record exit times.
- Testing window can be displayed in English, Spanish, Portuguese, Italian, Polish, Hungarian, or Chinese.
- Data base can be easily read, edited, imported, and exported by a variety of programs.
- Data base (.txt file) is virus and worm proof

TERMINOLOGY

Static fields can build up on humans as they walk along an insulative surface such as a carpet. A person with a high voltage static charge can destroy or damage an integrated circuit or FET device either by touching or coming close to it. Thus most electronic assemblers wear wrist straps or heel grounders to keep the wearers at the same voltage potential as the parts they are assembling. Wrist straps and heel grounders/shoes may also be worn at chemical plants, explosive materials factories and storage areas.

A **wrist strap** is simply a resistorized conductive cord that connects the wearer's wrist to a grounded conductive mat that covers the assembly bench. The resistor protects the static sensitive device as well as the worker.

A **heel grounder** is a small resistorized strap that connects the wearer to their special conductive floor surface. This requires that the floor be covered with a grounded conductive carpet, tile, mat or dissipative floor wax or paint (available through ACL). It is important that two heel grounders/shoes be worn to achieve proper static discharge.

Wrist straps and heel grounders simply act as a wire to drain off charges. However, to prevent accidental electrocution of the wearer (should the wearer inadvertently touch an external high voltage source) a high resistance is built into the strap. The resistance is typically between .5 to 2 megohms.

Thus straps and heel grounders have to be tested for two different malfunction conditions. If there is an open circuit or too high a resistance, then it will fail to prevent high voltage build up and no longer control dissipation. If there is a short circuit or too low a resistance (such as wet shoes), then it could fail to prevent electrocution, or could cause a rapid discharge which could emit a spark or cause a secondary effect.

The **Wrist Strap and Dual Heel Tester** checks the controlled conductive integrity of wrist straps and heel grounders/shoes for both of the fault conditions mentioned above. It can be attached to a free stand or can be a wall mounted. For use, the wearer simply inserts their wrist strap banana plug into the instrument, and stands on the foot plates (if wearing heel grounders or shoes), and presses the button. An LED display shows the results of the test (OK, low or high), and an alarm sounds if the resistance is not within its preset limits, and if the correct person and/or card is correctly identified from the data base. If the card or person is not recognized, there will be no LED lights and there will be a buzzer sound emitted.

If the computer data logging option is used then the actual resistance is displayed on the monitor, is automatically recorded in the computer, and can be printed in a daily/monthly report. If the resistance is changing day by day, the ACL-750 can be a valuable tool to predict failures before they occur.

Unlike other testers, the ACL-750 Dual Heel Tester tests both feet and wrist at once and separately, and does not require the wearer to shift feet and repeat the test. This saves time, and can insure proper testing. The ACL-750 cannot be fooled by a wearer who dislikes wearing two grounders and merely presses the button twice while stepping on the footplate with the same foot.

The EOS 20/20 standard mandates that a company must record the results when a person tests their wrist/heel straps to enter a static sensitive area, or must use a constant wrist strap monitor. In either case, when using shoes or heel grounders, a record must be kept. If a constant wrist strap monitor is used, the ACL-750 will test it as well, and notify the user if it has failed.

The tester software can generate a number of reports, including informing the supervisor if the wearer does not perform a test once or twice a day.

CALIBRATION VERIFICATION

The ACL-750 meter is calibrated to NIST traceable standards. The meter self calibrates itself with each use by comparing the surface mounted 1-megohm resistor value and capacitor against the unknown value. After one year of use, the meter can be sent to ACL, Inc. to be re-calibrated and be issued a new NIST traceable certificate. Please call ACL for the cost of this service.

ISO TRAINING AND CERTIFICATION OF ESD HANDLING AND CONTROL MEASURES FOR OPERATORS

A comprehensive interactive multimedia learning program with certification for those who work with static sensitive devices is available as an option. The training is directed to assemblers and support personnel.

Objectives

Participants successfully completing the program will be able to:

- Describe conditions most likely to cause uncontrolled electrostatic discharge
- Identify three types of ESD protective packaging
- Explain the use of ionization and topical antistats for static control
- Describe the impact of environmental factors on static charge
- Describe the function of ESD protective items in a protected area
- List the requirements of an ESD protective workstation
- Describe the correct use of ESD protective smocks, wrist straps, and footwear
- Recognize correct use of personal protection around high voltage hazards
- List recommended ESD protective practices at workstations

Qualification and Certification Testing

The training course incorporates interactive learning checks throughout the instructional sequences. Certification tests are criterion-referenced and module-based with feedback on every response for enhanced learning. The tests also include a scorebar to provide the learner with continuous status information. Administrative access to dates and scores of tests, certifications, and re-certifications is compliant with ISO quality-standards requirements.

Standards Compliant

The courses meet and comply with the ANSI/ESD S20.20 ESD control program guidelines as well as to JEDEC JESD625, IEC 61340-5, and IPC-610 standards.

Learning station system requirements

Install the training course software on the computer that the employees will be trained. The computer learning station will require:

- a PC style Pentium class computer with a Microsoft operating system Windows 2000/XP is preferred.
- a color monitor
- speakers.
- a network connection to the EsdTest server so that the EsdTest server can read the training course data base
- an internet connection to transfer license codes over.

Setup of training courses

The training course is sold on a per seat license basis. A separate license seat must be pre purchased from ACL for each employee who takes the course. Once the course is taken, a license seat is good for a 12 month period. If you have not purchased a group of license seats yet, please contact ACL.

The training course installation software is located on our EsdTest installation CD. After installing the EsdTest software, a window will appear and ask if you would like to install the training software. The software can also be installed later by opening the LTechCP1 subdirectory on our installation CD, and running Setup.exe. The training course installation manual LTechInstallationGuide.pdf is also located in that subdirectory.

Install the software on the training course CD, as per the installation directions contained in the training course CD package. Once the course software is installed, the course software will ask for the company name, telephone number, and email address. Once this information has been entered, the registration license number will be emailed back, and they can then be entered (or cut and pasted from the email) into the training program. The company ESD administrator can then either register the IDs of all the employees who will be taking the course (has to be the same ID as the one entered into the EsdTest system data base) into the training course system, or the employee/trainee can enter his/her employee ID when first registering to take the training course. Once registered, the trainee can sign in with just his name and ID number.

The AutoGenerate email report task scheduler should be setup to run the "Training" report every week or so.

Training Program Sequence of Events

1. Employees normally test their straps at the EsdTest station before entering the ESD sensitive work area.
2. A month or so before the employee's certification is due to expire, the test station will flash a warning.
3. Sometime during the next month, the employee should then spend one to two hours taking the recertification training course at the learning station computer. They must log in with their EsdTest ID number.
4. The EsdTest server periodically runs the "Training" report in the Auto email report generator task scheduler which then searches the training course data base for all similar employee ID numbers that are in the EsdTest data base, and updates the EsdTest data base certification dates with the date the employee passed the training course. The report will list all employees who have recently passed the training course.
5. If the employee does not pass the course before his/her certification date expires, they will not be allowed to test their straps (if the EsdTest certification window setup has been so configured).
6. To generate a list of expired or soon to expire employee certifications, run the Certification report.

TESTING OF WRIST STRAPS AND FOOTWEAR

Daily testing of wrist straps and footwear is mandatory to ensure the grounding devices function properly and to minimize charge generation on the human body, which may cause damage to integrated circuits. Partially conductive footwear and wrist straps are the primary techniques used to drain and minimize electrical charges from the body. The wrist and foot straps typically have a 1 megohm or two megohm resistor built into them. Too low a resistance can cause rapid discharge resulting in sparking and failures. Low resistance wrist or foot straps can also cause an electrical shock to the operator if he touches a high voltage circuit. On the other hand, open circuit or broken straps can cause high electrical resistant paths that result in static buildup, arcing, and integrated circuit damage.

To adapt to ISO-9000 certification the results should be recorded in a computer database or printed to hard copy as specified in EOS 20/20 specification.

BASIC SETUP

EQUIPMENT

Equipment Required

1. A computer with a 486DX or higher (Pentium or similar) microprocessor. Larger hard drives (2 G or more) will store more employee data.
2. Windows operating system (Windows 98/ME/NT/2000/XP).
3. An operable serial communication (comm.) port with the standard +/-12 volt signal levels, (or a USB port with a fully compliant +/-12V RS232 to USB converter) on the computer. HID/CASI-RUSCO/MOTOROLA™/AWID USB proximity readers require a USB port. The RS232 versions require an additional serial communication port (or USB to RS232 converter). Note that some laptops may not use the full legal standard +/-12 volt RS232 comm. port signal levels, so they will not work, in which case use an RS232/USB converter..
4. A LAN network-able system is needed for networking multiple testers. This may be a hard wire or wireless modem. (ACL is not responsible for the installation or maintenance of the network after the software is installed.)
5. To use e-mail feature, users will need a MAPI compliant e-mail program such as Microsoft Outlook 2000 (without the email security update) or Outlook Express. Eudora (www.eudora.com) also claims to be MAPI compatible.

Equipment Provided

- | | |
|-----------------------------|--|
| 1 – ACL-750 meter unit | 1 – ACL 742-Foot Plate w/ Allen head bolts and Allen head wrench |
| 1 – AC power adapter | 1 – ACL 733 (ACL 734 for HID) |
| 1 – 9 volt battery-alkaline | 1 – RS-232 Cord- must be used |
| 1 –CD with software | |

Equipment Options

1. PS2 connector for laptop connection
2. Barcode scanner (ACL 755)
3. Magnetic stripe reader (ACL 756)
4. HID™ Proximity Reader
5. Casi-Rusco™ Reader
6. Low profile footplate (FP-8755LP)
7. Rechargeable 9V battery – will be continuously recharged by RS232 power.
8. Certification training courses

HARDWARE INSTALLATION

Before You Begin

1. Make sure that a sample identification card has been sent to ACL for proper programming of reader.
2. Read the manual, help files, and other files on the C:\EsdTest directory.
3. If user will not be using the software function of the ACL-750 meter, disregard the software instructions in this manual.
4. Install the meter in view of the computer monitor, so employees that are testing can view the test results.
5. Take a deep breath, and know that with the innovative product line of ACL there is instant peace of mind.
6. At anytime, please contact ACL technical staff or refer to www.AclStaticide.com for technical support literature. Technical questions should be directed to info@AclStaticide.com.
7. Program updates are available at www.EsdTest-Acl.com.

Meter Assembly

1. For HID/CASI-RUSCO™/Indala/Motorola proximity card RS232 readers, two nine pin serial ports (or one if using an RS232 to USB converter for the card reader) are required on your computer. One for the ACL-750 meter and one for the HID/CASI-RUSCO™ proximity reader. The supplied RS-232 cords must be used. If there is a 25 pin DB25P on the computer, a DB25P to DB9P serial port adapter can be purchased from an electronic store like Radio Shack™. A USB to serial adapter for the card reader may be purchased from ACL.
For USB compatible proximity card readers, at least one USB port is required on your computer for the reader, and one nine pin serial port (or another USB port if using a fully compliant +/-12V RS232 to USB converter) for the ACL-750 meter.
2. Fasten the foot stand to the footplate. Place the foot stand on top of the footplate. Insert the small Allen head bolts through the holes in the circular plate on the bottom of the stand. Position these bolts into the T nuts located in the bottom of the footplate using the enclosed Allen head wrench. Tighten with Allen head wrench. **DO NOT OVER TIGHTEN.**
3. Position the HID/CASI-RUSCO™ reader (if purchased) on the right side or top of the top of the foot stand, where indicated by label. Place the RS-232 wire attached to the back of the HID reader down through the rectangle hole. Then attach the ACL-750 meter on the left side on top of the foot stand, where indicated by label. Place the meter so the top of the meter is flush with the top of the foot stand and is touching the HID reader on the right side. With the non-proximity stand (Bar Code or Magnetic stripe) position the meter so that the RS-232 plug does **NOT** protrude from the bottom and cause interference with the person being tested. Place the bar code or mag stripe reader on **TOP** of the stand.
4. Attach the two-plug power supply cord (see Illustration 1 – A) to both the ACL-750 meter and to the HID/CASI-RUSCO™ reader (if purchased). If a USB reader is used, a power supply for the reader is not required. The male plug is attached to back of the HID™ reader, through the small round hole besides the reader. The female plug is attached to the ACL-750 meter up through the hole of the stand into the front of the meter. Attach the RS-232 loose cable (see Illustration 1 - B) to the front of the ACL-750 meter. Use hook/loop strips and attach the ACL-750 meter and the HID/CASI-RUSCO™ proximity reader to the stand. With the meter alone or with bar code or mag stripe attach the one power supply unit.



Illustration 1

5. Insert the cords and wires inside the back of the foot stand allowing wire slack. Place the enclosed plastic shroud over the wire enclosure.
6. **Do not install an alkaline battery if the power supply is used.** IT MIGHT OVERHEAT AND RUPTURE. Use only the power supply **OR** the alkaline battery. You may use a rechargeable battery if desired.
7. Insert the other ends of the RS-232 cords into the computer.
8. An optional USB to fully compliant +/-12V serial RS-232 converter may be purchased. Many of the less expensive converters will not work.
9. Plug the footplate lead (see Illustration 1 – C) completely into the tester socket "Heel Plate".
10. Plug in the power supply.
11. Remove the protective film from both the metal plates on the footplate.
12. Install the card reader if purchased.
13. Turn on the computer. (Turning on the computer before the hardware is installed **may** not allow the Windows operating system to properly run.)

Meter Adjustments

The ACL-750 can be adjusted to various electrical resistance specifications by opening the meter case and pressing the dipswitches corresponding to the desired test ranges (see chart below). For units manufactured after 3/12/2002, the ACL-750 will alarm according to the ESDTest software set points, unless disconnected from the computer. The software parameters can be set in the software under 'Set up', 'User Information', and entering desired information in 'Strap Parameters' In the individual User Information menu . (see below), or later entered for everyone at once in the Setup "Change All Limits" menu (discussed later).

The resistance ranges depend on what test standard, i.e. (EOS-CECC) the user follows. The user must know what resistance range values are acceptable for their floors, shoes, and heel/toe grounders and according to either EOS or European standards. The 750 Meter is preset to the EOS ESD standard based on the 2020 specification (represented in **bold** under "Dip Switch Settings" on page 11). Attempt to keep the default (meter DIP switch settings) specifications the same as the computer. That way, the combo meter will display the correct set points if the computer is off. The system can be programmed to use the default (inside meter) by using a **default setting of "dipswitch"(or -1).**

Dip Switch Settings for 100M unit

The following resistance alarm values may be set inside the combo meter.
The factory settings are represented in **bold**.

<u>Foot Low</u>	<u>sw1</u>	
.5M	off	(use this setting for 100K lower limit option meters)
.75M	ON	(US & IEC default)

<u>Wrist Low</u>	<u>sw2</u>	
.5M	off	(or for 100K lower limit option meters)
.75M	ON	(US & IEC default)

<u>Foot High</u>	<u>sw3</u>	<u>sw4</u>	<u>sw5</u>	
2M	off	off	off	
5M	ON	off	off	
10M	off	ON	off	
25M	ON	ON	off	
35M	off	off	ON	(IEC & CECC default)
50M	ON	off	ON	
75M	off	ON	ON	
100M	ON	ON	ON	(US default)

<u>Wrist High</u>	<u>sw6</u>	<u>sw7</u>	<u>sw8</u>	
2M	off	off	off	
5M	ON	off	off	
10M	off	ON	off	(US default)
25M	ON	ON	off	
35M	off	off	ON	(IEC & CECC default)
50M	ON	off	ON	
75M	off	ON	ON	
100M	ON	ON	ON	

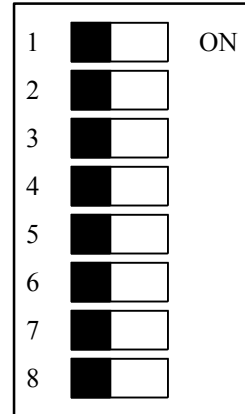

Figure 1 Dip switch - see table for settings

A special 1000 megohm unit is also available. See below.

Dip Switch Settings for 1000M unit special unit

The following resistance alarm values may be set inside the combo meter.
The factory settings are represented in **bold**.

(For new dual range meter, remove jumpers W4 and W5. Add jumper W2)

<u>Foot Low</u>	<u>sw1</u>	
0 (none)	off	
.75M	ON	(default)

<u>Wrist Low</u>	<u>sw2</u>	
0 (none)	off	
.75M	ON	(default)

<u>Foot High</u>	<u>sw3</u>	<u>sw4</u>	<u>sw5</u>	
20M	off	off	off	
50M	ON	off	off	
100M	off	ON	off	
250M	ON	ON	off	
350M	off	off	ON	
500M	ON	off	ON	
750M	off	ON	ON	
1000M	ON	ON	ON	(default)

<u>Wrist High</u>	<u>sw6</u>	<u>sw7</u>	<u>sw8</u>	
20M	off	off	off	(default)
50M	ON	off	off	
100M	off	ON	off	
250M	ON	ON	off	
350M	off	off	ON	
500M	ON	off	ON	
750M	off	ON	ON	
1000M	ON	ON	ON	



Door Relay

Units that are ordered with the a door-opening relay option will be equipped with two pigtail wires found on the right side of the unit. There are two male bayonet type plugs attached to these wires. There are two unwired female jacks attached to these male plugs, which can be attached to the open/close schematics on the door/bell circuit board (connected to the door mechanism). The relay in the ACL-750 is a single throw, low voltage single pole normally open relay. When the user passes a test, the relay is activated and remains closed for about 3 – 5 seconds after the user releases the test button. Units manufactured after 1/30/2006 have an activation time adjust trimpot in them which can be used to adjust the door open time from about 1 – 9 seconds (see photograph below).

The relay is rated .5 amps at 24 volts. It is illegal to introduce voltages greater than 24V into this unit, since shock hazards could possibly occur. Please refer to the schematics of a footplate door opening mechanism. Substitute the two wire door wires for the two-wire connection of the door foot-switch or hand-switch. The door in a facility has a second relay, usually of a higher voltage of 110 or 220VAC that allows voltage into the door electrical motor that opens and closes a door. This relay can be activated by a press button, a proximity sensor, or a floor switch as in a super market. When a person passes the combo meter strap tests, the low voltage relay in the combo meter is closed thus allowing current to pass into the higher voltage door relay and activate the motor in the door. When the low voltage relay in the meter opens the reverse happens – the high voltage relay in the door is opened thus stopping the door current, and the door closes.

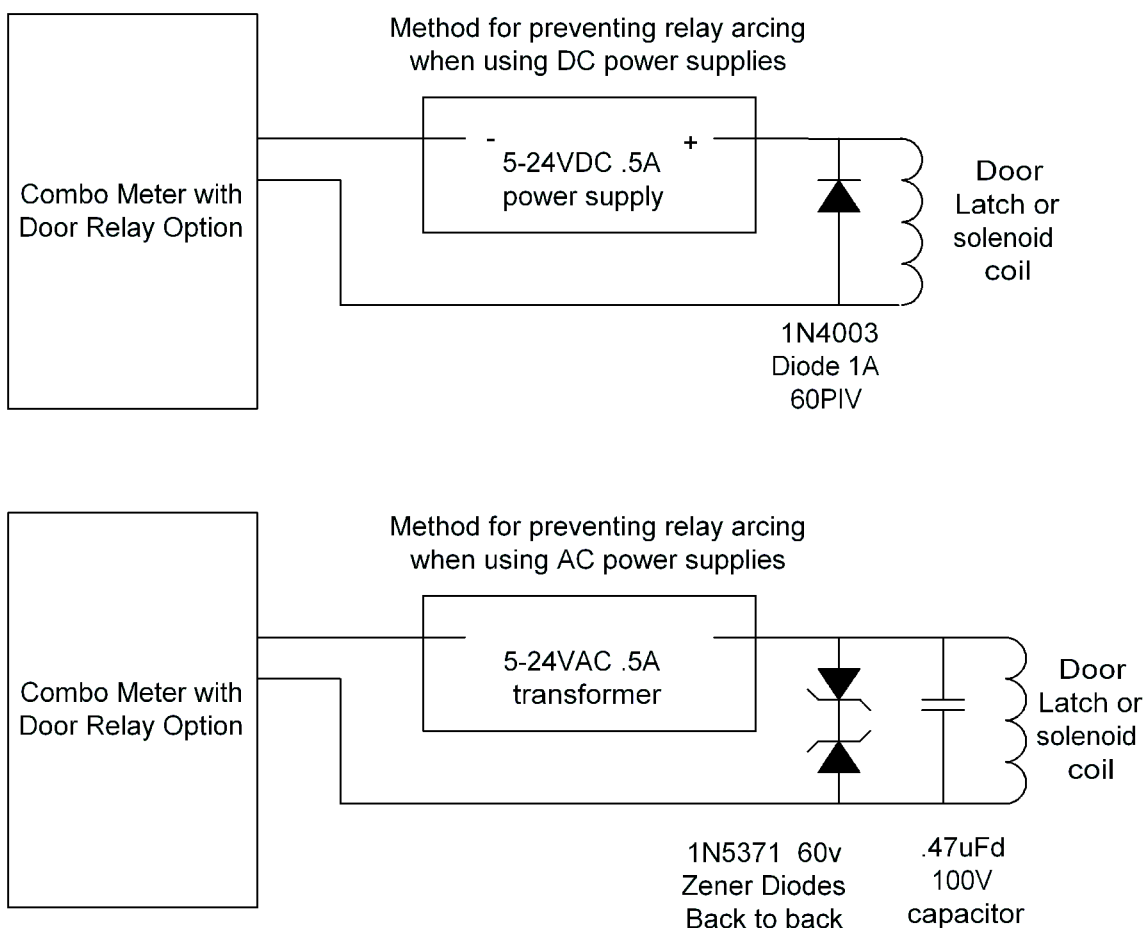

If the door relay contact is in series with a high current inductive load door latch such as a large solenoid or electromagnet, then arcing can develop across the relay contact when the contact breaks the circuit, and shorten the relay life.

To prevent relay contact arcing if the contact current is DC, then a diode (such as a 1N4003 or 1N4004) across the coil leads, with cathode (band side) on the positive lead, may be wired across the contacts. The diode should have a PIV (peak inverse voltage) rating of at least twice the DC voltage.

To prevent relay contact arcing if the contact current is AC, then two zener diodes back to back (band to band) may be wired across the coil leads. The zener voltage should be at least twice the AC voltage. If running 24VAC (30VAC open load?), use two 60 volt 1N5371B zeners.

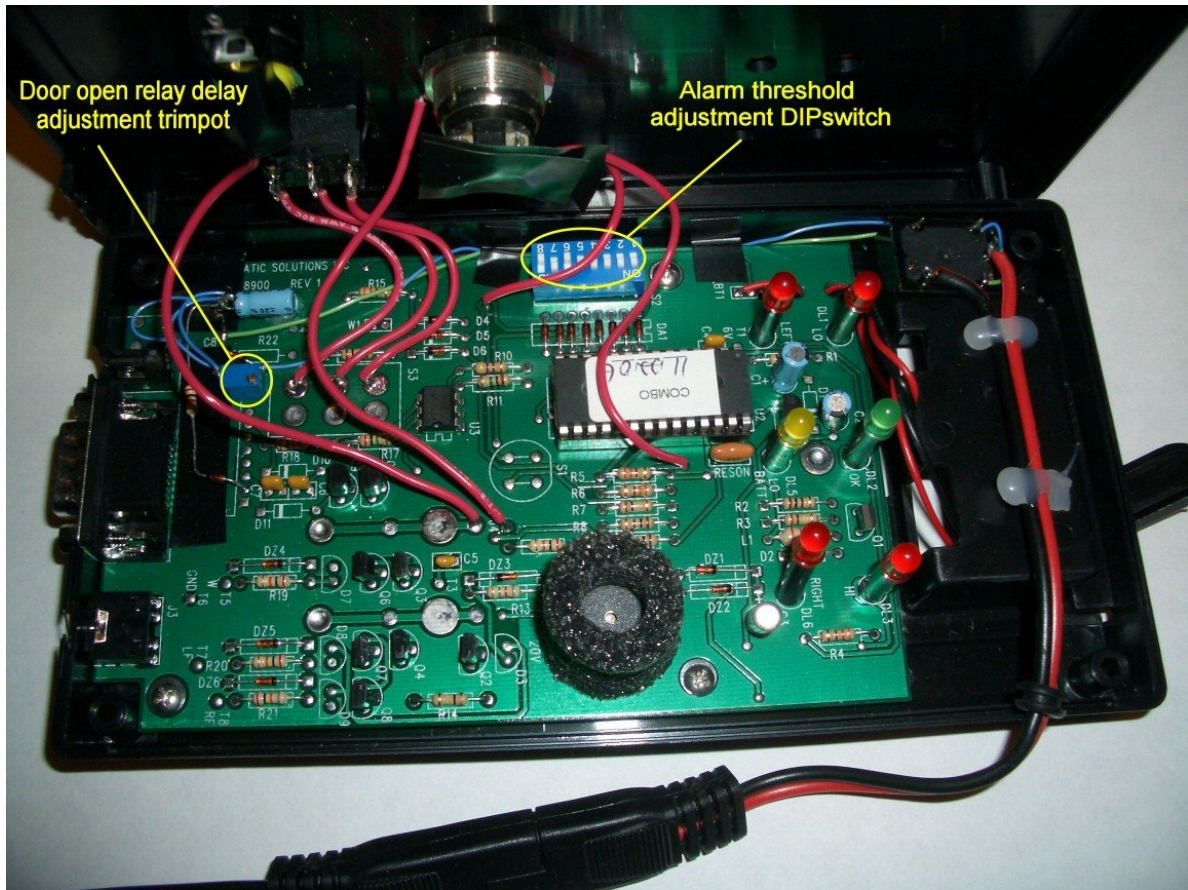

Set the "Door open relay delay adjustment trimpot" for the desired door opening time.

Multi-station hardware setup

Multiple meters may be connected to one computer via ACL's numerous multi-station options which include RS232 to wired Ethernet converters, RS232 to wireless Ethernet converters, or multi RS232 port PCI cards in a computer. The specific hardware installation and setup instructions of these options are included in separate manuals that are supplied with each of these options.

Some of these options require the meter to be connected to a remote computer located quite some away, in which case the following section applies.

Long distance wiring warning advisory

The following advisory only applies to meters that are connected to remote computers via long cables:

As with any long distance wiring, proper grounding precautions should be considered. If the building in which the test stations are located is improperly wired, or contains ground faults, or if the computer power supply is faulty, a shock hazard may exist.

If the tester is connected to the computer via a cable, and if the computer is located outside the local area, a voltage potential difference could arise if the computer ground is not at the same voltage potential as the local ground near the test station. For example, if the computer ground differed by 40 volts from a light switch cover plate on the wall located near the test station, and if an employee touched the light switch while pressing the test station test button or standing on the test station foot plate, a mild electrical shock hazard might arise. The tester has internal 20K limiting resistors to mitigate such a problem, but not eliminate it.

Thus it is advisable

- not to locate the test station within reach of a metal object that might be grounded
- and/or connect the meter ground (i.e. the power supply connector outer ground terminal) to the local ground

When finished installing the test stations, be sure to test, and periodically retest, the voltage potential from the ACL-750 combo tester push button to the nearest local ground. If the building is properly wired, there should normally be no more than a few volts difference.

Neither ACL Inc, nor its distributors, accepts any liability for such hazards, as stated in the liability disclaimer.

SOFTWARE INSTALLATION GUIDE

Software Installation for First Time Installation of New Software

1. Close all open programs. If installation problems arise, then close anti-virus programs also.
2. Insert the CD into the CD reader.
3. If the CD does not start automatically, select "RUN" From the start menu and type: D:\setup and press enter. Follow instructions.
4. If the following message is displayed, "A file being copied is older than the file currently on your system. It is recommended that you keep your existing file. Do you want to keep this file? ", Select Yes. If the user is reinstalling this software due to a computer error after already having input data, do not copy over the log.txt or names.txt files.
5. After installing the software, a small window will pop up asking if you want to check for newer versions on the internet. Note the present version number. If the computer is connected to the internet, then you may press yes. Follow the instructions below for "upgrading to a minor version change".
6. To create an EsdTest program startup icon on your desktop as a shortcut, click Start, Programs and select the EsdTest icon in the ESD Test folder to use as an icon to copy. Click on it, hold the left mouse button down, drag the icon onto the desktop, press the Ctrl key to duplicate it, and release the mouse button. This should create icon on the desktop identical to the one in the start menu. If you ever loose the start menu icon, you can also generate the desktop icon by using Windows Explorer to locate the ESD Test folder on the hard drive, usually in the C:\EsdTest directory. Open it and right click on the EsdTest.exe file icon. Select Create Shortcut in the menu, and then drag the newly created shortcut it onto your desktop.

Software installation for Upgrading to a Minor Version Change

When updating any software, it is advisable to first back up your present data. If all the data is contained in the c:\EsdTest directory, then just back up this directory (as in step A below).

To get the latest software updates, run the EsdTest program and press the Help, "Check for software updates" menu item. This should open an internet browser to www.EsdTest-Acl.com. Close the EsdTest program. If the version shown in the update link on the website is newer than the present version, then:

1. Click on the top update link,
2. Download the update program
3. The unzip window should open
4. Modify the file destination folder box if necessary
5. Click Unzip

Software Installation for Upgrading to a Major Version Change

Follow these instructions to upgrade from ver 6 to ver 8, or from ver 7 to ver 8.

A - Backup everything.

1. Open Windows Explorer (not Internet Explorer). Either hold the Windows Logo key and press the E key, or click on the MyComputer desktop icon.
2. If there are not 2 panes (columns) then click on the Folders icon so that you see 2 panes. The left pane should now say Folders.
3. Left click on the Local Disk (C:) drive item to expand it. All its folders should then be displayed beneath it.
4. Right click on the EsdTest folder and select Copy.
5. Right click on the Local Disk (C:) drive item and select Paste.
6. A new folder should have been created that says "Copy of EsdTest".
7. Left click on this new backup "Copy of EsdTest" folder and you should see all the files displayed in the right pane. There are 5 crucial ones: Names.txt, Log.txt, EsdTest.ini, GenReports.txt, and Netlist.txt. If these exist, then you can proceed to uninstall.

B - Uninstall old program

8. Close or minimize window explorer.
9. Click the Start icon on the lower left toolbar

- 10 Click Settings and/or Control Panel
11. Click Add/Remove Programs
12. Wait for all the programs to be displayed.
13. Left click on EsdTest
14. Left Click on Uninstall
15. Left click on OK.
16. The program should now have been uninstalled.

C - Install new program

17. Insert the new CD or run the new installation file
18. The CD should auto-boot and ask standard installation questions. If it does not auto-boot then open Windows Explorer again, click on the CD drive, and click on Setup.exe. If you can not find Setup.exe then see if EsdTestVer8xxIS4.exe is there and click on it.
19. Once installed, a pop up window should appear and ask if you want to check the web for updates. Click yes which will open Internet Explorer and take you to the update website, then click on the newest update. Updates can also be gotten later by opening the EsdTest program and clicking on "Help", "Check for software updates".
20. If the EsdTest program is open then close it.

D - Copy the old data files (in Copy of EsdTest directory) back to the EsdTest directory

21. Open Windows explorer again (as you did in steps 1-3 above)
22. You should see all the directories in the left hand pane.
23. Left click on the "Copy of EsdTest" directory.
24. You should see all of its files in the right hand pane.
25. Hold down the Ctrl key and while holding it down left click once each on the following 5 files: Names.txt, Log.txt, EsdTest.ini, GenReports.txt, and Netlist.txt.
- 26 Keep holding the ctrl key down. You should now see those 5 files highlighted in blue.
27. Keep holding the ctrl key down, and right click on one of the 5 files, and select copy.
28. Release the ctrl key.
29. Right click on the EsdTest directory in the left hand pane, and select paste.
30. If a message asks you if you want to over write a file, then make sure the file dates seem logical and then click yes.

E. - Check operation

31. Boot up the EsdTest program in the EsdTest directory. It should boot up and say ver 7.12 or higher. If you miss reading the boot up logo, then just click Help About.
32. Check the names. They should be your old ones.
32. Run a report. It should show your old test data.

F. - Notes

For future updates, you will never have to do all this again, just click on Help "Check for software updates". It is a good idea to occasionally back up everything anyway (as in steps 1-7).

STARTING THE PROGRAM

The EsdTest program may be automatically run upon computer boot-up by placing a program icon in the Programs Startup folder. Click Start, Programs and select the EsdTest icon in the ESD Test folder to use as an icon to copy. Click on it and hold the left mouse button down, drag the icon into the Programs Startup folder, press the Ctrl key to duplicate it, and release the mouse button. This should create a copy of the program icon in the startup folder identical to the one in the start EsdTest menu.

To start the program, manually click on the EsdTest icon in the Program Start menu or in the desktop. The program should begin and appear as in the following example:

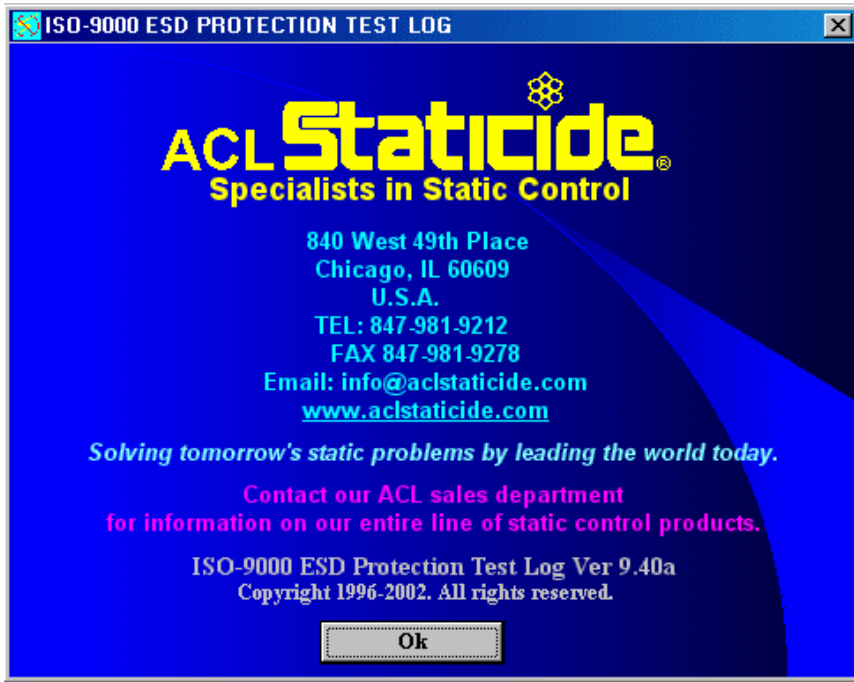

Help

Clicking the help item will give the following choices:

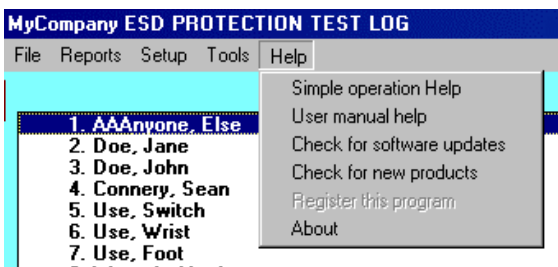

1. "Simple operation help" will list a help text file. This file (help.txt) can be modified with a word processor to give help specific to your company.
2. "User Manual Help" will call Adobe acrobat (if it is installed) and display the user manual. This action requires the EsdTest administrator's password.
3. "Check for updates on website" will go to the EsdTest website if an internet connection and browser exist, and download the latest EsdTest software. This action requires the EsdTest administrator's password.
4. "Register this program" is no longer used.
5. "About" lists the EsdTest program version number on the window shown at the top of this page.

If you have not yet plugged in a card reader (if purchased), then close the program, shut down the computer, and follow the installation instructions below.

CARD READER INSTALLATION INSTRUCTIONS

For the following card readers, see the designated sections of this manual:

DEVICE	SEE SECTION
Non RS232 Barcode readers (includes keyboard wedge and USB barcode readers)	Keyboard Wedge and USB Bar Code Reader or Magnetic Stripe Reader Installation
RS232 barcode readers (and RS232 Mag Stripe readers) Use this setting even with RS232 to USB converter cables.	General RS232 Reader Installation
USB interface proximity card readers. This does NOT include RS232 readers that have an RS232 to USB converter on them that use virtual com port drivers	USB Reader Installation
HID 5352 with ACL RS232 converter	CASI-RUSCO Weigand, HID 5352, HID RW-400ä, AWID SP-6820 RS232 Reader Installation
HID RW-400	CASI-RUSCO Weigand, HID 5352, HID RW-400ä, AWID SP-6820 RS232 Reader Installation
CasiRusco 94x, 97x Weigand, with ACL RS232 converter	CASI-RUSCO Weigand, HID 5352, HID RW-400ä, AWID SP-6820 RS232 Reader Installation
Awid Sentinel-Prox SP-6820	CASI-RUSCO Weigand, HID 5352, HID RW-400ä, AWID SP-6820 RS232 Reader Installation
All other RS232 interface proximity card readers (for almost all of the multi-station systems)	General RS232 Reader Installation

Quick Setup

To set up	In the employee selection window select
-----	-----
USB Barcode reader*	USB
USB Mag stripe reader*	USB
Keyboard wedge Barcode reader*	USB
Keyboard wedge Mag stripe reader*	USB
USB proximity card reader	USB
most RS232 proximity card readers	General RS232**
most RS232 barcode readers	General RS232**
most RS232 mag stripe readers	General RS232**
old HID 5352 reader	(see manual)
old HID RW-400ä reader	(see manual)
old CASI-RUSCO 94x, 97x Weigand	(see manual)
old AWID SP-6820	(see manual)

* NOTE: if some barcode or mag stripe characters must be skipped then use the following

To set up	Select
-----	-----
USB Barcode reader	Barcode-Mag (non RS232)**
USB Mag stripe reader*	Barcode-Mag (non RS232)**
Keyboard wedge Barcode reader*	Barcode-Mag (non RS232)**
Keyboard wedge Mag stripe reader*	Barcode-Mag (non RS232)**

** NOTE: Also select "Edit Reader Parameters" to choose which characters to use

Keyboard Wedge and USB Bar Code Reader or Magnetic Stripe Reader Installation

(i.e. unit is a keyboard wedge device that sends the badge number followed by a carriage return.)

1. NOTE: If your unit has a PS2 connector port for your keyboard, you will have to obtain a 5-din pin adapter from a local electronics store. (Radio Shack)
2. Un-package the magnetic stripe reader or bar code reader and unravel cord.
3. Unplug your computer's keyboard from the back of the CPU.
4. Plug the magnetic stripe reader or bar code reader (male end) into the keyboard socket in the back of the computer.
5. Plug the keyboard into the female terminal on the magnetic stripe reader or bar code reader. Attach the reader on the top of the stand.
6. The magnetic stripe reader or bar code reader is now ready to use. Position the reader on TOP of the stand. Position the ACL-750 directly below the reader so as the RS-232 does not protrude.
7. Turn computer on.
8. Install software
9. Read, "help files".
10. Open ESD program- Click "Set up".
11. Click "Employee Selection Configuration"
12. Select Bar code/Mag reader. This is same setting if using magnetic stripe reader.
13. Select "by scanning badge number"
14. If you do not want the numbers to be displayed for safety reasons select the Don't Show Numbers box.
15. Press "Edit Reader parameters".
16. Press "all" under Characters to use.
17. If you want to automatically enter new badges click all the 4 boxes in the unrecognized employee configuration window.

The screenshot shows a Windows-style dialog box titled "Employee selection and test configuration window". The window has a blue title bar with standard minimize, maximize, and close buttons. The main content area is light gray and contains several sections of settings:

- Enter employee identification via:** A group of radio buttons for selecting the identification method:
 - Keyboard
 - Barcode-Mag (non RS232)
 - USB interface readers (includes HID, Casi-Rusco, Indala, Mifare, etc. proximity cards)
 - General RS232 reader
 - Casi-Rusco 94%, 97%
 - HID 5352 reader
 - HID RW-400 reader
- Identify Employee:** A group of radio buttons for identifying the employee:
 - from list of names
 - by scanning badge number or typing name or badge number
 - by scanning badge number or or typing badge number
 - by scanning badge number or typing ID number or badge number
 - by scanning badge number or typing name, ID number, or badge number
- Don't show numbers:** A checkbox with the text "(Do not display badge or ID numbers while scanning badges)".
- No Monitor:** A checkbox with the text "(Will cause RS232 window to look for test data after test OK.)".
- No Keyboard:** A checkbox with the text "(Will cause some question boxes to default)".
- Simulate Mode:** A checkbox with the text "(Only available in training version.)".
- Allow employee:** A checkbox with the text "to change own sick time".
- Show results:** A checkbox with the text "of non required strap."
- Show last person:** A checkbox with the text "that tested".
- Ask for password:** A checkbox with the text "before each test".
- Blink if OK to test:** A checkbox with the text "(for new units)".

At the bottom right of the window, there are two buttons: "OK" and "Cancel". There is also an "Edit reader params" button in the top right corner and a "Help" button in the middle right area.

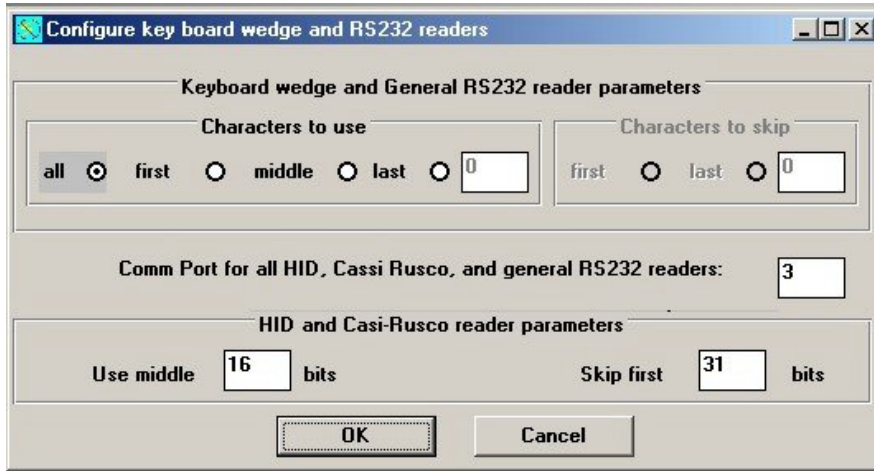

Trouble Shooting if Scanner Does Not Read Correctly

1. If your card- reader configuration is incorrect the card will not work. The reader must be programmed for your card configuration. I.e. tracks 1,2,3 or 1 and 2, or 2 and 3 etc.
2. Try reversing your card around and offering the readable side on the reverse side. Pass card faster or slower. Clean with water or alcohol if dirty.
3. Make sure the reader has been pre programmed to send a carriage return after a scan
4. Check characters to use configuration. If problems still continue send a sample card to ACL.

USB Reader Installation

A USB reader automatically reads and decodes the card, and injects the number into the keyboard stream. It is powered by the USB cable so does not need a power supply. Setup the software by clicking the “USB” option as shown in the following picture. When the USB option is selected, the “Configure Reader” button will be hidden since no other configuration is needed.

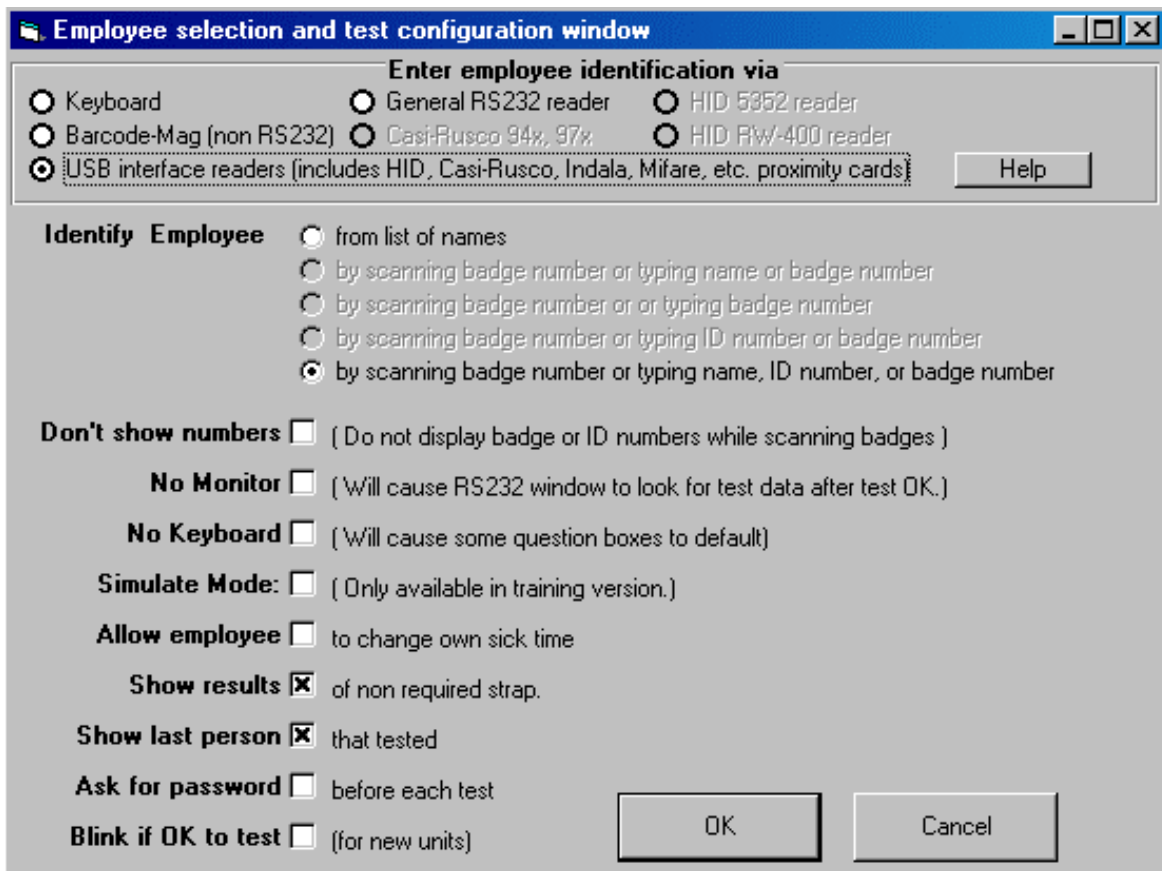

Trouble Shooting if USB scanner Does Not Read Correctly

The reader must be preprogrammed to read and decode the card correctly, and end with a “return” character. To test, open Microsoft Notepad, type a few characters to see them displayed, then read a card and it should also be displayed. If the badge number is not displayed correctly, then return the reader, a typical card, and a note with the desired badge number to be read from the card, to ACL Inc for reprogramming.

Note that RS232 readers connected to an RS232-USB converter acts like RS232 input readers and not like USB readers, so see the “INSTALLING CASI-RUSCO, HID, AWID RS232 READERS” section below.

General RS232 Reader Installation

For all RS232 card readers that transmit at

- 9600 Baud
- 8 bits
- No Parity
- No Handshaking

Can use the General RS232 check box.

Note: The computer must have two working serial ports installed on the computer. One for the meter and one for the reader. A low cost two serial port card is available from any computer store. However, if a USB port is preferred, an optional USB converter with USB to Com port driver may be purchased from ACL.

The screenshot shows a Windows-style dialog box titled "Employee selection and test configuration window". The window has a blue title bar with standard minimize, maximize, and close buttons. The main content area is divided into several sections:

- Enter employee identification via:** This section contains three columns of radio buttons. The first column has "Keyboard", "Barcode-Mag (non RS232)", and "USB interface readers (includes HID, Casi-Rusco, Indala, Mifare, etc. proximity cards)". The second column has "General RS232 reader" (which is selected), "Casi-Rusco 94x, 97x", and "USB interface readers (includes HID, Casi-Rusco, Indala, Mifare, etc. proximity cards)". The third column has "HID 5352 reader" and "HID RW-400 reader". To the right of these buttons is a button labeled "Edit reader params".
- Identify Employee:** This section contains five radio button options:
 - from list of names
 - by scanning badge number or typing name or badge number
 - by scanning badge number or or typing badge number
 - by scanning badge number or typing ID number or badge number
 - by scanning badge number or typing name, ID number, or badge number (which is selected)
- Don't show numbers:** A checkbox (unchecked) with the text "(Do not display badge or ID numbers while scanning badges)".
- No Monitor:** A checkbox (unchecked) with the text "(Will cause RS232 window to look for test data after test OK.)".
- No Keyboard:** A checkbox (unchecked) with the text "(Will cause some question boxes to default)".
- Simulate Mode:** A checkbox (unchecked) with the text "(Only available in training version.)".
- Allow employee:** A checkbox (unchecked) with the text "to change own sick time".
- Show results:** A checkbox (checked) with the text "of non required strap."
- Show last person:** A checkbox (checked) with the text "that tested".
- Ask for password:** A checkbox (unchecked) with the text "before each test".
- Blink if OK to test:** A checkbox (unchecked) with the text "(for new units)".

At the bottom right of the window are two buttons: "OK" and "Cancel".

Press the "Edit reader parameters" button and:

- Select "all characters" (unless you want to skip some)
- Enter the com port number

Configure key board wedge and RS232 readers

Keyboard wedge and General RS232 reader parameters

Characters to use: all first middle last 0

Characters to skip: first last 0

Comm Port for all HID, Cassi Rusco, and general RS232 readers: 3

HID and Casi-Rusco reader parameters

Use middle 16 bits Skip first 31 bits

OK Cancel

Trouble Shooting If the RS232 reader card does not work.

1. Incorrect comm. ports will not allow the system to work. Check if they are operable and if they are correctly connected. The tester and reader must NOT be on the same ports.
2. Press the test press switch for at least two seconds.
3. Try rebooting the computer after everything is installed.
4. Open Microsoft Hyperterminal (Start, Programs, Accessories, Communications, Hyperterminal) and see if it can receive the transmitted characters.

CASI-RUSCO™ 94x, 97x weigand, HID 5352, HID RW-400™, AWID™ SP-6820 RS232 reader Installation

Note: These readers are no longer officially supported. They can not be directly selected in the entry window. However, they may still be selected by manually editing the "Barcode" parameter in the EsdTEst.ini file (0=keybd 1=barcd 2=HID5352 3=Casi 4=GeneralRS232 5=HIDrw400 6=USB). If upgrading from an older software version that used these readers, simply copy the old EsdTest.ini file to the C:\EsdTest directory so the new software will use it.

The computer must have two working serial ports installed on the computer. One for the meter and one for the reader. A low cost two serial port card is available from any computer store. However, if a USB port is preferred, an optional USB converter with USB to Com port driver may be purchased from ACL.

1. Attach the HID™ 5352 reader to the ACL HID to RS-232 serial comm. port. Converter, and plug the converter into the computer. Connect the CASI RUSCO™ 94x, 97x reader to the ACL CASI RUSCO to RS-232 serial comm. port. Converter, and plug the converter into the computer. Attach the two-plug power supply. Male to the HID or Casi-Rusco unit and female to the meter. Test the card to see if the unit reads green and emits a 'buzz' sound.
2. Check the HELP files on the C:\EsdTest directory for any later updates.
3. Open the 'Employee selection Configuration' screen and press the appropriate box for HID 5352, or CASI-RUSCO Wegand in addition to the character and bit information. (See figure below.) The RS232 box is for a Motorola unit with a Wiegand to RS232 converter, or any other reader with a general RS232 output.
4. Click the appropriate box in the Identify Employee section to select if an employee is to be identified by having an employee:
 - select their name from a list of names
 - or by automatically scanning a badge number or typing name, ID number, or badge number if the badge is lost
5. If you do not want the numbers to be displayed for safety reasons select the Don't Show Numbers box.
6. If there is no monitor, the "NoMonitor" box may be selected. This will continue to take data if the test button is pressed again, even after a good reading. This may only be required for some circumstances when using RS232.
7. If there is no keyboard, select the No Keyboard box to bypass any of the question boxes.
8. "Simulate mode is only used in some demo programs. It is not used for actual testing.
9. If the employees are to enter their own sick/vacation schedule then check the "Allow employees to change own sick time" box.
10. If the employee has multiple straps but is not required to test all of them, click the "show results of non-required strap" to allow the employee to see the results of all the tests.
11. If it is desired to show the last person that tested on the login screen, then check the "show last person that tested" box.
12. If it is desired to require an individual employee password for each employee that tests, then check the "ask for password before each test" box.
13. On new models of the tester that have an extra "employee recognized – OK to test" LED, select this box.
14. Press "EDIT READER PARAMETERS"
15. For HID 5352 readers select the HID 5352 option, for a standard "26 bit" HID card enter Use 16 bits and enter Skip first 31 bits (because the RS232 version adds extra bits.) If the 8 bit facility code is to be included in addition to the 16 card number bits, then use 24 bits and skip first 23 bits. For an HID "37 bit" card, use 31 bits and skip the first 16. Parity and checksum bits are not checked.
16. For the HID RW-400 reader (10-16VDC) select the HID RW-400 option in the reader configuration window. Skip 11 bits and use 16 for their demo cards.
17. For CASI-RUSCO 94x, 97x Weigand cards, the full 38 bits can be read by setting the bits-to-use to 38 and the bits-to-skip to 1. To only read the 6 digit employee id (which is the last 19 bits of the 38 bit data field) set Bits-to-use to 19 and set bits-to-skip to 20 (although some cards require setting bits-to-skip to 24).
18. If an Awid Sentinel-Prox SP-6820 reader is used, then select the "HID 5352" option in the reader configuration window. Set Bits to use = 16, bits to skip = 17. If this gives too many digits on some cards then use 12 bits and skip the first 21 bits. The number read from the card is the same as the number printed sideways on the rear of the card near the edge (i.e. 01897).

SEND A CARD TO ACL FOR PROPER REGISTRATION

Trouble Shooting if the card does not work.

5. If either the card reader configuration or bits to use or bits to skip is incorrect the card will not work.
6. Incorrect comm. ports will not allow the system to work. Check if they are operable and if they are correctly connected. The tester and reader must NOT be on the same ports.

7. Press the test press switch for at least two seconds.
8. Try rebooting the computer after everything is installed.

PROGRAM SETTINGS

1. Open the EsdTest program
2. Select "Setup"

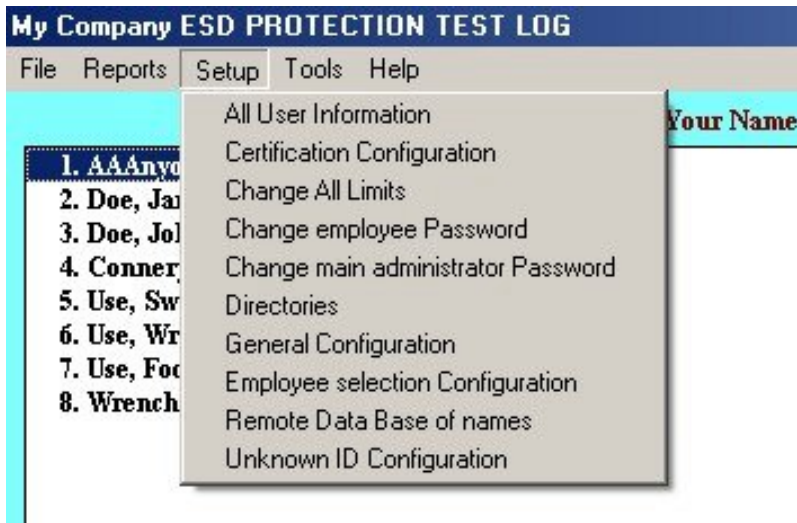

General Configuration

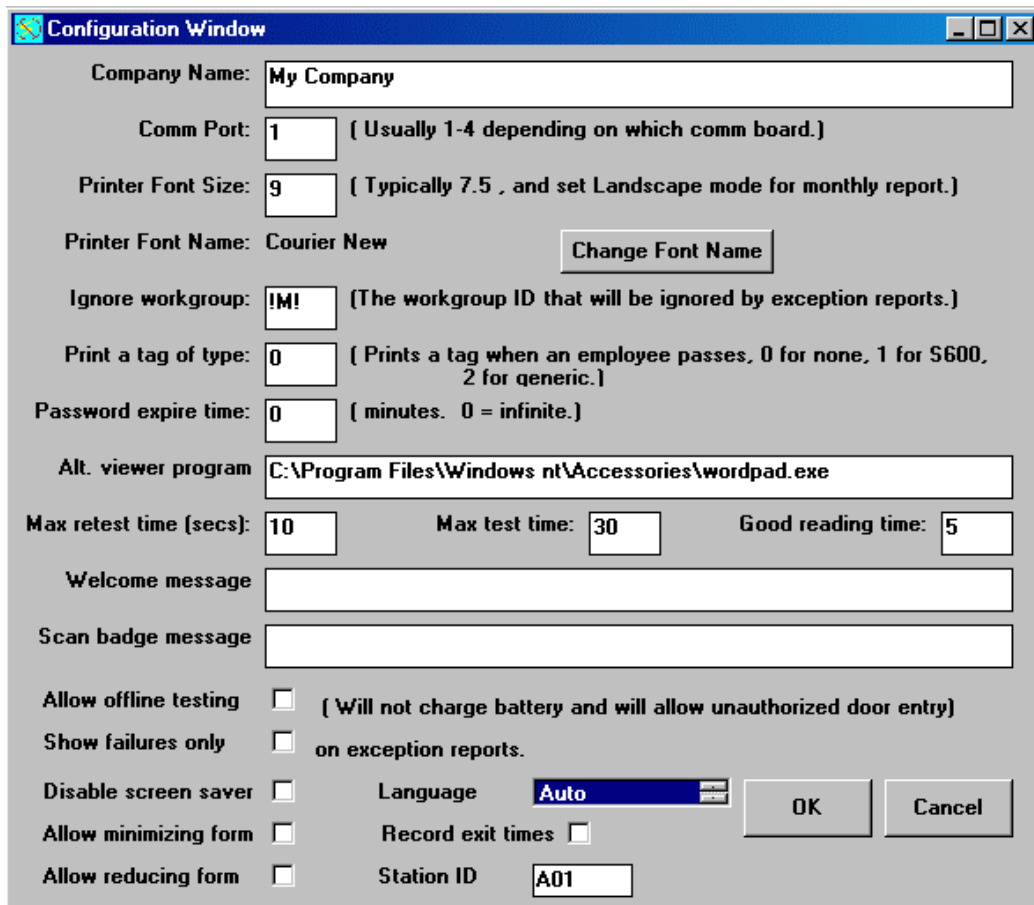

- Enter the Company Name. Do not use commas or periods.
- Enter the serial com port number that the RS-232 cable is connected. The default is 1. If the EsdTest program will only be used as a server, and never have a meter connected to it, a zero can be entered.
- Select the printer 'Font Name' item from the 'Setup' menu, and select a fixed font width font such as Courier, Courier New, Terminal, System or Fixed. Print a report by selecting the 'Reports Menu' and clicking on 'Print Monthly'. The user should pick a month with 31 days in order to check the proper type width. The printer setup should be in the Landscape mode. Check the printout. Adjust the 'Printer Font Size' item of the 'Setup' menu to expand or contract the lines to fit the page. Select size 7.5 font.
- The configuration menu contains an ignore workgroup box. If maintenance workers need to be tested but not included in the exception report, then enter the maintenance workgroup prefix to be ignored in the exception report.
- A label can be printed every time an employee passes by setting the tag type box to 1 (if a Zebra S600 printer is connected), or 2 (if a general purpose printer is connected), or 0 if no tag is to be printed. If sending to a Zebra S600, make sure that the default printer configuration in Start Settings Printer is set to a Generic Text printer driver.
- If a report overflows the text viewer, an alternative viewer can be selected by inserting the path into the Alt Viewer Program line of the Setup General Configuration Window.
- If the test fails, the test window can be made to time out for any period from 1-30 seconds if another test is not conducted. This way the following employee will see a failed test window left on the screen. This time is set from the General configuration window, in the "Max retest time" text box. Setting it to 0 will cause the test window to never time out.
- The time that a good test reading is displayed may be varied by changing the "Good Reading time" text box. This interval is in seconds, and may include a decimal point.
- The Welcome message can be modified for different languages by entering new wording into the Welcome Message text box. Leaving it blank will default to "Welcome".
- The "Please scan your badge" message can be modified for different languages by entering the new wording into the Scan Badge Message text box.
- If the "Allow Offline Testing" box checked, the program will allow the combo tester to conduct measurements even if the employee is not logged in, but the combo meter will use its internal dip switch alarm values. Operation in this mode is not recommended because the employee could scan in with a faulty badge, not notice that the test window had failed to open, test, and think he had tested properly. Operation in this mode also prevents the internal rechargeable battery (if installed) from charging. Operation in this mode also allows unauthorized personnel to open the door (if the combo meter is equipped with a door opener relay). If testing of unregistered employees is desired, the preferred method is just to set up a dummy employee named AAAnyoneElse with a workgroup designation of ???, that way any unrecognized employees will be tested normally. Note - once an employee is logged in, the computer limits will be used.
- In the Exception reports, if it is only desired to show employees who have failed the strap resistance test, instead of showing all employees in that workgroup who either failed, or did not test, or who are absent, then click the "show failures only on exception reports" check box. Note that this option is not recommended, since it will not list employees who forgot to test.
- Some computer operating systems have automatic screen savers that blank the screen and ask for a password after an inactive period of no keyboard entry. This screen saver timeout can either be disabled by turning it off at the operating system level (recommended) or disabling it by clicking on the "disable screen saver" check box.
- If it is desired to allow the employees to minimize the program when the administrator password is enabled, then click the "Allow Minimizing form" box.
- If it is desired to allow the employees to show a reduced size program when the administrator password is enabled, then click the "Allow Reducing form" box. If the title bar is double clicked, the program will reduce in size. Double click it again to return to full size.
- The language options for the testing window can be chosen in the language window. See the section on "Language display".
- To run the "record exit" option, click the "Record Exit Times" check box. This will record the time that an employee left the area. To record an exit, swipe the badge but do not press the tester button. It is permissible for the next person swipes their card before the test window clears the screen. The test window time delay can be set in the General Configuration window. To view the entrance and exit times in a report, use either the "Daily" report or the "Individual" report. (The "View Entire Log" report shows what was originally recorded in the log.txt file, so will display the entrance and exit times on separate lines)
- If it is desired to know which station a test was conducted from, then enter a station ID in the "StationID" box. This parameter can then be added to the remote data base test log. Use an ID such as A01 where A is the facility, and 01 is the station number at that facility.

Change All Limits.

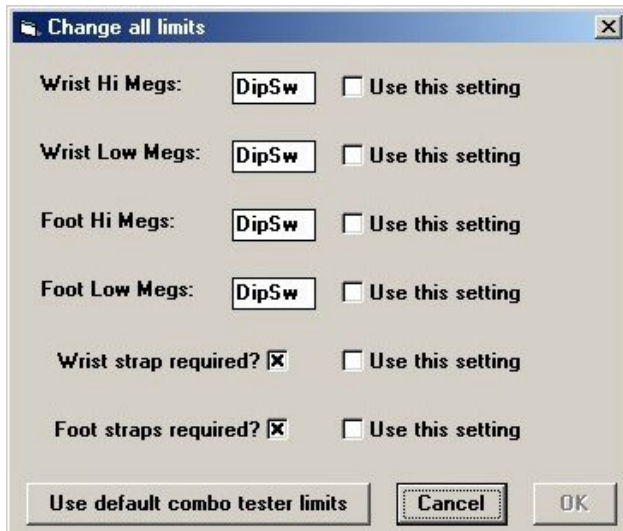

Change all limits

Wrist Hi Megs: Use this setting

Wrist Low Megs: Use this setting

Foot Hi Megs: Use this setting

Foot Low Megs: Use this setting

Wrist strap required? Use this setting

Foot straps required? Use this setting

This is under the 'Setup Menu' "Change All Limits". This screen can be used to reset the parameters for the wrist and foot strap alarm resistances of all employees. The wrist strap and heel grounder defaults may also be selected. Resistance values from 0.10 megohms to 99.99 megohms for the minimum and maximum alarm conditions may be entered. *A special 1000 megohm model PROM is also available. However, it is recommended that you enter the alarm conditions at which the tester internal dipswitches are set. These may be determined later by running a test and reading the set point conditions in the 'Received' window. The dip switch setting on the tester overrides the "Wrist Used" and "Foot Used" criteria in the user 'Setup' menu.

By using "DipSw" or "-1" in all fields, the parameter settings will automatically match the dipswitch settings inside the meter. For example, the wrist low would be .75 because dipswitch 2 is turned on. If the user puts dipswitch 2 to the off position (.5M), -1 would then be .5 Megs. (See limit switch settings chart).

Change Administrator Password

A password protection can be activated in order to access the setup parameters and the data. . Select 'Change Password' under 'Setup' and type in the new password.



Password

Enter the old administrator password.

If using a password, it will only be asked for once. If a password was previously entered and is no longer required, select 'Change Password' and leave the field blank when selecting a new one.

Unknown ID Configuration'

The program will also allow automatic addition of new badges if an unknown badge number is read during testing. This may be enabled in the 'Unknown ID Configuration' menu under the 'Setup'.

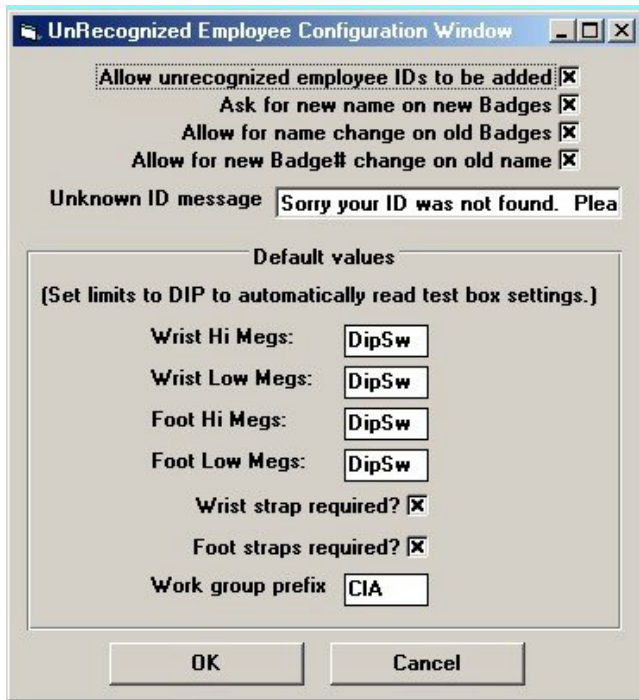

The parameters are as follows:

- Allow unrecognized employees to be added - If this is the only box checked, the employee will be entered with the Name and ID as the badge number.
- Ask for new name on new badge – If this box is also checked, the program will ask the employee to enter a name.
- Allow for name changes on old badges – If this box is checked, and if the F1 key pressed during testing, the program will ask the employee if the name needs to be changed.
- Allow for new badge# change on old name – if “Ask for new name on new badge” is checked, and if an employee scans a new badge and enters his name, the program will check the name to be sure it does not already exist with an old badge number. If it does, the old badge number will be changed to the new badge number.
- Unknown ID message – if none of the above boxes are checked, and if “AAAanyone else ???” does not exist in the names.txt file, then this message is displayed. This message can be changed to any message.

User Information

Enter the desired user information. Select ‘Setup’ from the main menu and “all user information”.

User Information -

- LastName: The employee' last name with no commas or spaces.
- First Name: The employee' first name with no commas or spaces.
- Grp: The workgroup designator (department) with no commas, spaces, dashes, or colons. One to four characters are recommend for best report formatting
- ID: Employee's ID number with no commas, spaces, dashes, or colons. Try to keep under 9 characters for best report formatting
- Badge: Employee's ID number with no commas, spaces, dashes, or colons. Try to keep under 9 characters for best report formatting
- Wrist Low Megs: The low resistance alarm setting. Use "DipSw" to read the combo meter dip switch settings.
- Wrist Hi Megs: The high resistance alarm setting. Use "DipSw" to read the combo meter dip switch settings.
- Foot Low Megs: The low resistance alarm setting. Use "DipSw" to read the combo meter dip switch settings.
- Foot Hi Megs: The high resistance alarm setting. Use "DipSw" to read the combo meter dip switch settings.
- Wrist Strap check box: Check this box if wrist straps are required
- Foot Straps: Check this box if foot straps are required. Check neither box to use the combo meter toggle switch.
- Leave Status: Select a leave status if desired or type a letter into the box.
- Leave date from: Starting date of leave
- Through date: Ending date of leave
- Update button: Update the dates entered above so can add more dates
- Yearly summary button: Show the yearly status summary.
- Certification Type: Enter a company defined certification type
- Certification Expiration date: Enter the date the certification expires. Can use the optional training course if desired.

Up to 30000 employee names and information may be added. There are 9 sample users already in the software, which may be deleted after the user studies them as examples. The names can be manually entered with data base software such as Access™.

- There are five **command buttons** at the bottom of the user information screen: **Append, Insert, Modify, Delete Cancel.**
- When the 'User Information' is selected, the first employee will automatically pop up. It can be typed over with the new user's information. This feature allows the default settings to be used repeatedly. Once new user information is typed over

the default settings, the user should press '**APPEND**'. This will create a new number for that user at the bottom of the list.

- If you would like to insert a new employee at a certain point in the list, select the name you want the user to come before in the list. Type over the information with the new user's information. When finished, press **INSERT**. This will put the new user ahead of the person you selected.
- Anytime information is changed for a user, use the **MODIFY** command when finished to save all changes.
- To move between users in the general configuration screen, use the side toolbar under the word list. This will advance to the next or previous user.

Directories

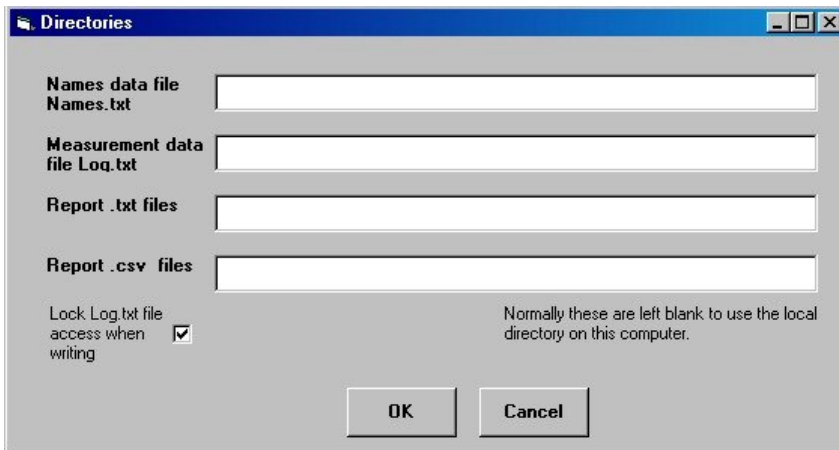

Can set different directories for the Names.txt file, Log.txt file, report.txt files, and report.csv files in the Setup, Directories window. Normally these entries are left blank to default to the local EsdTest working directory, but for simple networking, they may be set to point to the main server directory (see networking help below). If one master log.txt file is used, and if problems arise with multiple servers writing to it at the same time, then file locking may be selected by placing a check in the checkbox. If the log.txt file is local to the computer, this option should not be used (i.e it should not be checked).

Change Employee Password



An option exists to allow employee to enter their own sick time. Enable this option by selecting the Employee Selection Configuration window, and checking the "Allow employee to change own sick time". Set a password for this feature by selecting the Change Employee Password item in the Setup window. If the password is set to no characters, then it will be ignored. When an employee tests his/her strap, there will be a box that says "Modify Sick Time" on the lower right corner of the main test results window. An employee can now click this box. The employee password will be asked for (if it was not set blank). A sick time modification window will be displayed (without the certification data shown), and the employee can then modify this. You can show explicit help instructions for your company's sick/vacation policies by modifying the file named HelpVacation.txt, which can be modified with any word processor.

Certification Configuration

The screenshot shows a dialog box titled "Certification Expiration Notification Configuration". It contains several fields and options:

- "Days before the certification expiration date to give a warning notice. Set to -1 to disable. Set to 30 for a 1 month advance notification." with a text box containing "-1".
- "Interval of days before repeating the warning notice. Set to 7 to be reminded every week. Set to 0 to be reminded each time logged in." with a text box containing "-1".
- Three radio button options:
 - Never allow access to expired certificate users.
 - Allow Expired Certificate users entry with this password (requires keyboard). A text box next to it contains "-1".
 - Always allow access to expired certificate users (default).
- "Certification training data base file path" with a text box containing "C:\LTRRecords\LTRRecords.mdb".
- "Interval of months before retraining is again required." with a text box containing "12".
- "OK" and "Cancel" buttons at the bottom.

To warn an employee of impending training certification expiration, limit access of employees with expired certification, and automatically update the certification expiration date, use the Setup Certification Configuration menu. Enter the days of advanced warning. Set to 0 to disable advanced warnings. Enter the number of days interval between notifications. Set the interval to 0 to notify the employee every time they log in. Check one of the three option buttons to: exclude all employees with expired certificates, allow expired employees access if they know the password (and enter the password - make sure it is different than the administrator password) (must have a keyboard for this option), or allow all expired employees access. The "Training" report can automatically update the certification expiration dates from a ACL training course (contact ACL for pricing). Also enter the retraining interval in units of months. To update the certification dates click the Reports Training button, or periodically run the Training function from the AutoGenerate email task scheduler

Remote Data Base Setup for accessing employee names

Introduction

The EsdTest program typically uses the EsdTest data base file (Names.txt file) to store employee names, badge numbers, Id number, and other information. However a customer's existing remote data base can also be used. Typical data bases include Oracle, SQL2000, Access 2000, and most other SQL type data base servers.. The EsdTest program can be set up to do one of the following:

1. Find an employee in the remote data base if the employee can not be found in the EsdTest Names.txt file data base, and add that employee's information to the EsdTest data base.
2. Only use the remote data base and never use the EsdTest Names.txt file data base. Note that this method will prohibit using most of the EsdTest report features, and will only work as long as the network and remote data base server are functioning.
3. Use the remote data base, but keep a local copy of it to use if the network or server stops functioning. Note that this method will prohibit using the EsdTest sick/vacation report features.
4. Only use the EsdTest data base file (Names.txt file).

The operating characteristics are further described here.

Method 1 – Uses the remote data base only if the employee can not be found in the EsdTest Names.txt file data base, and adds that employee's information to the EsdTest data base. For example, if John Smith is a new employee and has not been entered into the EsdTest data base, then without this feature he would not be recognized. What this feature does is:

Testing sequence

1. When a person swipes his badge, look up the badge number in the EsdTest Names.txt data base and retrieve the last

- name, first name, and id#
2. If the person is not found in the EsdTest data base, then look up the person's badge number in the Remote data base. If the person is found there, then get the ////////////////person's ID number from the remote data base, and search the EsdTest data base for the person's id#
 - a. if it already exists then update that person's badge number in the EsdTest data base
 - b. else add the person to the EsdTest data base
 3. If the employee is not found in the remote data base either, and if the Unknown employee setup window is configured to accept unknown employees (see adding unknown employees in the main help file), then the employee may key in his name and be added to the Esdtest data base.
 4. Otherwise the employee will be rejected and not allowed to test.
 5. If recognized, the employee may then proceed with the test, and the test data is stored in the EsdTest log.txt data base, and/or a remote log data base (see Remote test data base help file)
 6. The Esdtest data base can be later exported back to the remote data base if desired

Method 2 – Only use the remote data base and never use the EsdTest Names.txt file data base. Note that this method will prohibit using most of the EsdTest report features, and will only function as long as the network and remote data base server are functioning. Editing the employee information from the EsdTest program can only be done by another copy of the EsdTest program running in Method 1, 3, or 4 and importing the entire remote data base into the EsdTest Names.txt file, editing it, then exporting back to the remote data base. What this feature does is:

Testing sequence

1. When a person swipes his badge, look up the badge number in the Remote data base and retrieve the last name, first name, and id#
2. If the person is not found in the EsdTest data base, then the employee will be rejected and not allowed to test.
3. If recognized, the employee may then proceed with the test, and the test data is stored in the EsdTest log.txt data base, and/or a remote log data base (see Remote test data base help file)

Method 3 – Use the remote data base, but keep a local copy of it to use if the network or server stops functioning. Note that this method will prohibit using the EsdTest sick/vacation report features. What this feature does is:

Testing sequence

1. On program boot, copy the entire remote data base to the EsdTest Names.txt file data base. Note that this overwrites all the previous data and clears all sick and vacation data.
2. When a person swipes his badge, look up the badge number in the remote data base. If the person is not found in the remote data base, then the employee will be rejected and not allowed to test.
3. If the person is found in the remote data base, then update the EsdTest data base if that person is not already in there.
4. If the remote data base or network is unavailable, then look up the employee in the EsdTest Names.txt file data base. If the person is not found in the remote data base, then the employee will be rejected and not allowed to test.
5. If recognized, the employee may then proceed with the test, and the test data is stored in the EsdTest log.txt data base, and/or a remote log data base (see Remote test data base help file)

REMOTE DATA BASE CREATION

Create a view with a name like ESD_EMP_BADGE_VW to the company data base with the following fields:

LAST_NAME (will be holding data like - Smith)

FIRST_NAME (will be holding data like - Fred)

BADGE (will be holding data like - 3852)

DEPT (will be holding data like - CIA)

EMPID (will be holding data like - 12345)

WRIST_USED (will be holding data like - 0 or 1) this field is not required

FOOT_USED (will be holding data like - 0 or 1) this field is not required

CERTIFICATION_EXPIRATION_DATE (will be holding data like - 10/28/2006) this field is not required

It may be best to have all fields be text (char) fields, although the CERTIFICATION_EXPIRATION_DATE field can be a date field.

For Oracle create an ODBC driver instance and a DSN name such as ESD.

If writing names or certification dates to the remote database will never be used, then the remote data base can be set up as read only.

EsdTest SETUP

Names Data Base Setup Window

Connect string:
Can leave connect string blank if data base does not exist.

SQL read prefix:

SQL write prefix:

SQL delete prefix:

Last name field:

First name field:

Badge field: aux Wrist used field:

Id field: aux Foot used field:

Group field: aux Cert expire field:

Usage:

- Only read the name from the remote data base if it is not in the Names.txt file, then add it to the names.txt file.
- Only read the name from the remote data base, never from the names.txt file.
- Import the remote data base to the names.txt file on bootup.
- Always try reading the name from the remote database but use the names.txt file if the database is unavailable.
- Never read the name from the remote data base, always use the names.txt file.

Buttons: Import names.txt file from remote database, Export names.txt file to remote database, OK, Cancel, Help

Click Setup, Remote data base of names to open the setup window and enter the following items:

Connect String: Enter the data base connection string which for Oracle might look something like:

Server=WPRPROD;DSN=ESD;UID=wpread;PWD=wpread

And for SQL2000 might look something like:

UID=;PWD=;Database=ESD_EMP_BADGE;Server=MYSERVER;Driver={SQL Server};DSN=;

And for Access .mdb might look something like:

Driver={Microsoft Access Driver (*.mdb)};Dbq=c:\EsdTest\EsdTest.mdb;Uid=Admin;Pwd=

SQL read prefix: Select the fields from the view by entering something like:

SELECT * TRANSFER.FROM ESD_EMP_BADGE_VW (if using Oracle)

Or SELECT * FROM ESD_EMP_BADGE_VW (if using SQL2000)

Or SELECT * FROM ESD_EMP_BADGE (if using an Access table)

If writing names to the data base then

SQL write prefix: Insert names by entering something like:

INSERT INTO ESD_EMP_BADGE_VW (if using Oracle)

Or INSERT INTO ESD_EMP_BADGE_VW (if using SQL2000)

Or INSERT INTO ESD_EMP_BADGE (if using an Access table)

If deleting names from the data base then

SQL delete prefix: Insert names by entering something like:
DELETE FROM ESD_EMP_BADGE_VW (if using Oracle)
Or DELETE FROM ESD_EMP_BADGE_VW (if using SQL2000)
Or DELETE FROM ESD_EMP_BADGE (if using an Access table)

If writing names or certification dates to the remote database will be used, then the remote data base must not be set up as read only.

Last name field: Enter the name of the field that contains the last name which should look something like:
LAST_NAME

First name field: Enter the name of the field that contains the first name which should look something like:
FIRST_NAME

Badge name field: Enter the name of the field that contains the badge number string which should look something like:
BADGE

Group field name: Enter the name of the field that contains the Group string which should look something like:
DEPT

Id field name: Enter the name of the field that contains the Id string which should look something like:
EMPID

Wrist used field: (optional) Enter the name of the field that contains the Wrist used value (should be 1 if using wrist straps and 0 if not required to use wrist straps)which should look something like:
WRIST_USED

Foot used field: (optional) Enter the name of the field that contains the Foot used value (should be 1 if using foot straps and 0 if not required to use foot straps)which should look something like:
FOOT_USED

Certification expiration date field: (optional) Enter the name of the field that contains the Certification expiration date which should look something like:
CERTIFICATION_EXPIRATION_DATE

Operation

Method 1 Operation

Click the top radio button in the Setup Remote Data Base window

To add employees to the EsdTest Names.txt file data base:

If the setup boxes are not blank, and if an employee scans his badge and is not found in the local data base, the program will automatically search for unknown employees in the remote data base

To delete (scrub) employees who are no longer in the remote data base from the EsdTest data base, and update employees who's name, badge number, group, strap requirement, or certification expiration date has changed (but who still has the same ID number, and still has either the same last name or the same badge number), either:

Manually click on Reports, "View or Print Update modify/remove employees using remote data base" report

Automatically – Enter the Update function in the AutoGenerate email task scheduler. This should be done after running a GetNames to combine all the names from other test stations, and before a SendNames to send the combined names.txt data file back down to all the test stations. Since this might take a while, it should probably be done during a period when other reports are not needed to be run.

Note that the Scrubbing will be aborted if more than 50% of the names in the EsdTest data base are not found in the remote data base, as a safety measure to prevent too many names from being scrubbed in case of a remote data base error.

However, WHEN USING THE UPDATE/SCRUB FEATURE, KEEP GOOD BACKUPS OF THE NAMES.TXT DATA BASE just in case. You can use the BackupNames function in AutoGenerate email, or click on Tools Backup names.

Scrubbing will not add employees from the remote data base to the EsdTest, it will only modify (update if already there), or

delete. This prevents the entire corporate employee listing from being added – employees will only be added as they test.

Method 2 Operation (remote data base only)

Click the 2nd radio button in the Setup Remote Data Base window. All employee editing features and most reports are disabled.

Method 3 Operation (remote data base if available)

Click the 3rd radio button in the Setup Remote Data Base window. If the employee information editor is used, it will only modify the Names.txt file, so the Names.txt file will need to be exported to the remote data base (see Tools menu)

Method 4 Operation (never use the remote data base)

Click the 4th radio button in the Setup Remote Data Base window

An example Access 2000 data base (EsdTest.mdb) is included in the EsdTest directory. The best way to get familiarized with this feature is to use this example. You can open it with MS Access or other data base editing program to see what the table looks like, then close it. Set up our Remote Data Base configuration window to use this data base (EsdTest.mdb) as instructed above. Copy and paste the configuration parameters from this file into the set up window. Setup the Employee Selection configuration window to use Keyboard and Identify employee by scanning name or badge#. When the "Please type your badge#" window appears, type 12321. This badge number is not currently in our example names.txt data base, so the remote data base feature will look for it in the EsdTest.mdb data base and add it to the Names.txt data base.

Remote Data Base Setup for storing resistance test data

Description

This feature allows the storing of resistance test data in a remote database such as Oracle, SQL2000, or Access 2000 (even though the data is already available in the EsdTest log Log.txt). For example, after James Bond presses the test button, the following information can be stored in the remote results database:

```
Date and time of test - 08/14/2005 01:02:03 PM
ID#                   - 007
Last name             - Bond
First name            - James
Workgroup designator: - HMSS
Wrist status          - Pass
Left foot status      - High
Right foot status     - Low
Wrist resistance      - 12.34
Left foot resistance  - 100.0
Right foot resistance - 0.03
```

Remote Data Base creation

Create a database with a name something like EsdTest, or use the remote names database. If using the remote names database, it must have writing privileges.

Create a table with a name like ESD_RESULTS in the results database with the following fields:

```
DATE_TIME (create as date/time field)
EMPID     (create as text or char field)
LAST_NAME (create as text or char field) optional
FIRST_NAME (create as text or char field) optional
DEPT      (create as text or char field) optional
WRIST_STATUS (create as text or char field) optional
LFOOT_STATUS (create as text or char field) optional*
RFOOT_STATUS (create as text or char field) optional*
WRIST_RESISTANCE (create as text or char field) optional*
LFOOT_RESISTANCE (create as text or char field) optional*
RFOOT_RESISTANCE (create as text or char field) optional*
```

optional* - Their should either be a STATUS or a RESISTANCE (or both) fields

EsdTest Remote Test Results Data Base setup parameters

Click Setup, Remote results database to open the setup window and enter the following items:

For Oracle create an ODBC driver instance and a DSN name such as ESD.

Connect String: Enter the data base connection string which for Oracle might look something like:

Server=WPRPROD;DSN=ESD;UID=user1;PWD=pword1

And for SQL2000 might look something like:

UID=;PWD=;Database=ESD_EMP_BADGE;Server=MYSERVER;Driver={SQL Server};DSN=;

And for Access .mdb might look something like:

Driver={Microsoft Access Driver (*.mdb)};Dbq=c:\EsdTest\EsdTest.mdb;Uid=Admin;Pwd=

SQL prefix: To insert the data into a table named ESD_RESULTS, the SQL prefix string would look like:

INSERT INTO ESD_RESULTS (if using an Access table)

If using the "Import measurements from the remote data base" feature to overwrite the log.txt file with the data from the remote data base, then add the following read prefix strings

SQL read prefix: Select the fields from the view by entering something like:

SELECT * TRANSFER.FROM ESD_RESULTS (if using Oracle)

Or SELECT * FROM ESD_RESULTS (if using SQL2000)

Or SELECT * ESD_RESULTS (if using an Access table)

To disable the storing of data into the remote results database, just leave the connect string or SQL string blank.

An example Access 2000 database (EsdTest.mdb) is included in the EsdTest directory. The best way to get familiarized with this feature is to use this example. You can open it with MS Access or other database editing program to see what the ESD_RESULTS table looks like, then close it. Set up our Remote Data Base configuration window to use this database (EsdTest.mdb) as instructed above. After an employee presses the test button on the test meter, the data will be entered into the database.

Usage:

There are four usage methods, each have their own radio button in the Setup, Test Results data base configuration window:

1. "Add test data to log.txt file and the remote data base". This adds data to both the data bases.
2. "Add test data to remote data base only" This only utilizes the customer's remote data base. Data will not be stored in the EsdTest log.txt file, and no EsdTest test reports can be generated. If the remote data base or network is not available then the test results will be lost.
3. "Add test data to remote data base only, but use Log.txt as a buffer if the remote data base is not available". This is similar to the above method, but will continue to operate during network failures by buffering (temporarily storing) the test data in the Log.txt file. When the network becomes available, the next person to test will cause the test records in the log.txt file to be transferred to the remote data base, and those test records that were transferred will be flushed (removed) from the log.txt file. Since data will not be stored long term in the EsdTest log.txt file, no EsdTest test reports can be generated.
4. "Add test data to log.txt file only". The remote data base will not be used.

Multiple Station Configuration and operation

The software will allow using multiple test stations with one computer, but it is not recommended, since the advantages of using one computer and monitor with every test station include:

- the employee can instantly see if his/her card has been accepted and what the results of the test are.
- The animation graphics are fairly easy to understand by people of any language, and the main test windows can be displayed in Spanish, Portuguese, Italian, Polish, Hungarian, or Chinese.
- The system will record data even if the network goes down.
- Most companies have a surplus of slow obsolete computers that will work in this application, so computer cost is not an issue. And if an old computer is not available, the cost of a new computer and monitor is less than \$400 total (e.g. Dell).

However, if it is desired to have multiple test stations run on one computer, then the following is required:

1. The card readers (card scanners) must have an RS232 output.
2. Each combo meter and each card reader require an RS232 cable back to the computer, or our RS232 to Ethernet converter option, or our RS232 to wireless Ethernet option.
3. The stations should be located within 100' of the computer (although 400' seems to work if the card readers are transmitting at low speed 9600 baud)
4. The computer should be a Pentium preferably with Microsoft XP, although 98 and 2000 should work.
5. For RS232 operation, the computer needs a PCI com port card with two com ports for each station. A typical 6 port card requires a PCI card slot for the card (which has 2 RS232 connectors on it), and two more back panel slots for the four additional RS232 ports (two per slot). USB to RS232 converters are not recommended. If you have to add one USB to RS232 converter, use it for the card reader, not the combo meter.
6. If more than 3 stations are being run from a multi-port serial card, one or more 8 port cards should be used, since the 6 port card requires 3 slots, but the 8 port card only requires one slot (since the 8 connectors cables hang out the rear). Four 8 port cards will drive 32 ports – which is 16 stations.
7. If it is desired to power the test station reader and combo tester through the serial cables to avoid having to provide AC-DC power supplies at the test station, then order the Power-Through-Serial-Cable option for the multi-port cards, the reader, and the combo tester.
8. Once the PCI com port card is installed, install its drivers. Refer to the separately provided multi-port serial card installation manual. Notes: you will probably have to install one driver for each added com port. Once they are installed, the Microsoft Hardware Device Manager should be used to check that each com port is functional. Next, a com port testing program (such as two Hyper Terminal windows and a null modem or loop back connector) should be used to determine which com port number

was assigned to which RS232 connector (on the PC rear panel), and the connectors should be labeled. Once the com ports have been labeled and verified, then proceed with the ESDTest software setup.

ESDTest program multiple station setup

- A. Open the ESDTest program
- B. Click on Setup
- C. Click on Multiple Reader Configuration

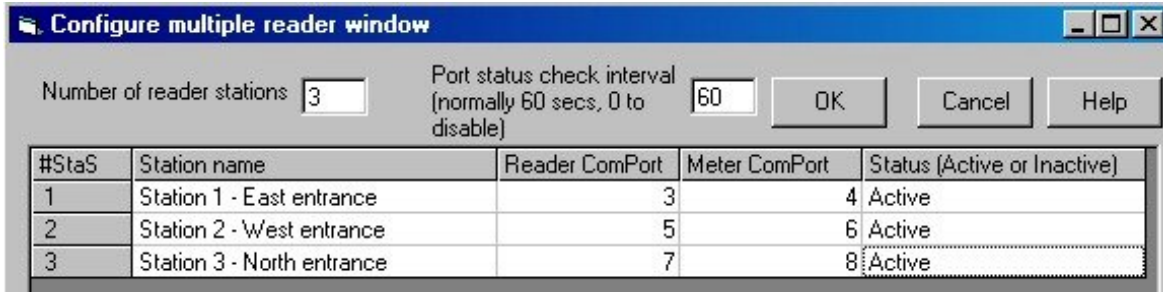

- D. Enter the number of stations (up to 16) that will be connected to the computer (a station is one tester and one card reader).
- E. Enter the Station name in the first column. This will be the name that is displayed in the status logs. An example would be "Station 1", or "Tester 1" or "East Entrance", etc.
- F. Enter the com port number that the card reader for that station is connected to. This will be a number 1 - 99 that you set up in step 6 above.
- G. Enter the com port number that the combo meter for that station is connected to. This will be a number 1 - 99 that you set up in step 6 above.
- H. Enter an A if the station is active (on line) or enter an I if the station is inactive (off line)
- I. Repeat steps E-H for each station.
- J. Enter 60 seconds into the port status check interval box. Some Ethernet to RS232 converters will require a setting of 0 to disable the check.
- K. Click OK when finished

Multiple Station Operation

When more than one station is entered into the Multiple Reader Configuration window, the software will enter the multiple station display mode. There are two display panes. The upper pane shows the present status of each station, and the lower pane shows the accumulated test log results.

DIGIKEY ESD PROTECTION TEST LOG

File Reports Setup Tools Help

Station status

Station	Name	Stat	Action	Employee ID	Employee Name	Readings
1	Station 1	OK	Pass	0041331026628	Employee, 0041331026628	W=03.45M=OK, L=56.78M=OK, R=67.89=OK, 00.50M<W<10.00
2	Station 2	OK	Time up - employee failed tes	716040	Employee, 716040	W=23.45M=HI, L=99.99M=HI, R=99.99=HI, 00.50M<W<10.00M
3	Station 3	Inactive				
4	Station 4	Inactive				
5	Station 5	Inactive				

Measurement Log

Date	Time	Sta#	Employee Name	Employee ID	Test Status	Wrist	L foot	R foot
11-09-2005	21:37:09	2	Employee, 716040	DIG-716040	FAIL ***	Whi 23.45 Megohms	Lhi	Rhi
11-09-2005	21:40:12	1	Employee, 0041331026628	DIG-0041331026628	FAIL ***	Whi 23.45 Megohms	Lhi	Rhi
11-09-2005	21:40:21	1	Employee, 0041331026628	DIG-0041331026628	Pass	Wok 03.45 Megohms	Lok 56.78 Megohms	Rok 67.89 Megohms
11-09-2005	21:47:51	1	Employee, 0041331026628	DIG-0041331026628	Pass	Wok 03.45 Megohms	Lok 56.78 Megohms	Rok 67.89 Megohms
11-09-2005	21:48:05	1	Employee, 0041331026628	DIG-0041331026628	FAIL ***	Whi 23.45 Megohms	Lhi	Rhi
11-09-2005	21:48:20	1	Employee, 0041331026628	DIG-0041331026628	FAIL ***	Whi 23.45 Megohms	Lhi	Rhi
11-09-2005	21:48:31	1	Employee, 0041331026628	DIG-0041331026628	Pass	Wok 03.45 Megohms	Lok 56.78 Megohms	Rok 67.89 Megohms
11-09-2005	21:48:47	1	Employee, 0041331026628	DIG-0041331026628	FAIL ***	Whi 23.45 Megohms	Lhi	Rhi
11-09-2005	21:49:16	1	Employee, 716040	DIG-716040	FAIL ***	Whi 23.45 Megohms	Lhi	Rhi
11-09-2005	21:49:25	1	Employee, 716040	DIG-716040	Pass	Wok 03.45 Megohms	Lok 56.78 Megohms	Rok 67.89 Megohms
11-09-2005	21:51:12	1	Employee, 0041331026628	DIG-0041331026628	FAIL ***	Whi 23.45 Megohms	Lhi	Rhi
11-09-2005	21:51:19	1	Employee, 0041331026628	DIG-0041331026628	Pass	Wok 03.45 Megohms	Lok 56.78 Megohms	Rok 67.89 Megohms

Language Display

The "Scan Badge" window and the "Test results" window can be displayed in different languages. The correct language should be displayed according to the Windows Regional language settings (Start, Settings, Control Panel, Regional and Language Options, Regional Options Tab), if the language mode is set to "Auto". This can be over ridden in the Settings, General Configuration, Language list box. Click the up or down arrow to select one of the following settings:

- Auto
- English
- Spanish
- Portuguese
- Italian
- Chinese
- Polish
- Hungarian

Be sure to also click on the language shown in the box, so that it is displayed in blue, to select it. Then click OK.

OPERATION

OPERATOR TESTING INSTRUCTIONS WHEN NOT USING THE COMPUTER

If using a computer for logging the test readings, proceed to the next section.

Wrist Straps

1. If NOT using the software and computer, position the switch located on the front of the meter to the wrist strap position. If using the software, the computer will recognize what you are testing without using the switch. If not using the computer the internal adjusted DIP switch setting will determine the pass/fail resistances.
2. Attach the wrist strap to the ground cord attached. Be sure the strap is in snug contact with the wrist. Dry skin, hair or foreign contaminants may cause failures for in-specification, well functioning wrist straps. ESD hand lotions will improve skin contact with wrist straps.
3. Insert the end of the ground cord into the appropriate banana jack located on the front of the Combo-Tester meter. The US female jack is on the left side and the constant monitoring 3.5 mm stereo plug is on the right side. Depress and hold the metal test plate until an LED illuminates. Software users should ignore tester LED's and watch the computer monitor. The software will test both the wrist straps and foot grounders simultaneously and display the results of both the resistances and pass/fail in one step.
4. If the green "OK" LED illuminates, the wrist strap is functioning within the resistance specification range and therefore may be used to handle static sensitive devices. If the monitor screen turns green, the test was also a "pass." Make sure the toggle switch is in the correct testing position.
5. If either the red "Too High" or red "Too Low" LED illuminates and the buzzer activates or the computer screen turns red, the worker must adjust and re-test the wrist strap cord immediately. To test a faulty cord, leave the cord plugged into the meter and detach the wrist cord from the strap. Press the wrist strap metal snap-end of the cord against the stainless steel test plate avoiding skin contact. If the cord tests "FAIL" replace the cord.
6. Replace a low battery immediately in order to assure accurate readings. When using the power cord do not use a nickel cadmium or alkaline battery. It is suggested to not use a battery or use either rechargeable battery which is charged via the RS-232 cable,

Do not install an alkaline battery if power supply is used. It may damage the tester and negate the warranty

Footwear

Testing shoes or heel/toe grounders require the unique dual stainless steel footplate.

1. Make sure the footplate lead is plugged **all the way** into the tester socket "Heel Plate." Low results will appear if plug not fully inserted.
2. Position the switch in the front of the meter to the dual heel footplate position (only required if not using the software.)
3. Stand on the footplate making sure that each foot is aligned in the left and right stainless steel pad and not touching both foot plates.
4. Depress and **hold** the metal test plate switch or button until an LED light illuminates or monitor screen displays readings.
5. If the green "OK" LED lights or the monitor displays green, then the foot grounders are functioning within the specifications.
6. If either of the "FAIL LOW" or "FAIL HIGH" red LED's illuminate along with the activation of the buzzer for either foot, or the display turns red, the user should check their shoe or heel/toe grounders and re-test. If both feet fail only one foot will display "FAIL" on the tester. When that foot is corrected the other foot will display "fail" until it is corrected.
7. If the buzzer emits a sound and there is not an LED display the card or person is not identified by the computer. Check the computer setting and or RS-232 cord.

The ESD foot-grounding device may be out of specification for the following reasons: poor skin-tab contact, dirt contamination, broken internal resistor, broken leads, etc.

OPERATOR TESTING INSTRUCTIONS WHEN USING THE COMPUTER

1. If you have a barcode/magnetic stripe scanner or a HID/CASI-RUSCO™ proximity reader, simply swipe the card. Otherwise click a name in the main selection window to begin a test. If no mouse is installed, press the arrow keys to move the cursor and press Enter. The operator's information window should appear and the 'Press Button' window should also pop up.
2. Insert the wrist strap banana plug into the reader. Be sure the strap is in snug contact with the wrist. Dry skin, hair or foreign contaminants may cause failures for in-specification, well functioning wrist straps. ESD hand lotions will improve skin contact with wrist straps. Stand on the footplate making sure that each foot is aligned in the left and right stainless steel pad and not touching both foot plates. Press and hold the tester button until the PRESS BUTTON window disappears and the test measurements are displayed on the main window. All the results and any error messages should be displayed (if software is enabled all readings will instantaneously be recorded in the database).
3. Click the 'Cancel button' (or press Enter key) to return to the 'Name Selection' menu. This will be automatic (adjustable 10 second delay) when using cards and by checking off the 'USE ID' and 'DON'T SHOW NAMES' under 'General Configuration'.

The ESD foot-grounding device may be out of specification for the following reasons: poor skin-tab contact, dirt contamination, broken internal resistor, broken leads, etc.

Troubleshooting high wrist readings:

1. Make sure the ground cord is attached to the wrist strap.
2. Make sure the end of the ground cord is plugged into the appropriate banana jack located on the front of the Combo-Tester meter. The US female jack is on the left side and the constant monitoring 3.5 mm stereo plug is on the right side.
3. Be sure the strap is in snug contact with the wrist. Dry skin, hair or foreign contaminants may cause failures for in-specification, well functioning wrist straps. ESD hand lotions will improve skin contact with wrist straps.
4. Be sure the wrist strap is not dirty
5. Make sure the metal test plate button is fully depressed until an LED illuminates
6. If not using an external power supply or the RS232 battery charging option, then check for a low battery condition and replace if needed. Do not insert a battery if using an external power supply.

Troubleshooting low wrist readings:

Replace wrist strap or check the wrist strap internal resistor reading

Troubleshooting high foot readings:

1. Make sure each foot is firmly touching its own foot plate
2. Make sure foot straps are not over insulative polyester socks or stockings
3. Make sure the footplate lead is plugged **all the way** into the tester socket "Heel Plate."

Troubleshooting low foot readings:

1. Make sure each foot is only touching its own foot plate
2. Make sure shoes are not wet.
3. Replace foot strap or check the foot strap internal resistor reading
4. Make sure the footplate lead is plugged **all the way** into the tester socket "Heel Plate."

Example of program waiting for the test button to be pressed:

My Company ESD PROTECTION TEST LOG

Press Button

Please plug in wrist strap
Step on foot plate

Press and hold the button

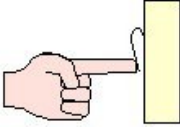

My Company ESD Protection Test Results

Operator Information

Operator's Name: Connery, Sean
Date: 08-06-2003 Time: 22:33:13
Wrist Strap: Required Foot Strap: not used
Wrist Low Setting: DipSw Foot low Setting: DipSw
Wrist high setting: DipSw Foot high Setting: DipSw

Action:

Please plug in wrist strap, Press and hold the button.

Received:

Results

Wrist:
Left foot: Right foot:

Cancel

Example of a good reading:

My Company ESD PROTECTION TEST LOG

File Reports Setup Help

1. AAAnyone, Else
2. Doe, Jane
3. Doe, John
4. Connery, Sean
5. Clinton, Hillary
6. Use, Switch
7. Use, Wrist
8. Use, Foot
9. Wrench, Monkey

My Company ESD Protection Test Results

Operator Information

Operator's Name: Connery, Sean
Date: 08-06-2003 Time: 22:45:58
Wrist Strap: Required Foot Strap: not used
Wrist Low Setting: .75 Meg Foot low Setting: .75 Meg
Wrist high setting: 10 Meg Foot high Setting: 100 Meg

Action:

OK

Readings OK thank you. Please press the Enter key
or click on Cancel.

Received: W=01.38M=OK, L=99.99M=--, R=99.99M=--,
00.75M<W<10.00M, 00.75M<F<99.98M

Results

Wrist: OK = 1.38 Meg
Left foot: not used > 100 Meg Right foot: not used > 100 Meg

Cancel



Example of a low wrist reading:

My Company ESD PROTECTION TEST LOG

Press Button

Please plug in wrist strap
Step on foot plate

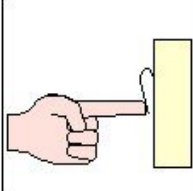
Press and hold the button

My Company ESD Protection Test Results

Operator Information

Operator's Name: Connery, Sean
 Date: 08-06-2003 Time: 22:47:52
 Wrist Strap: Required Foot Strap: not used
 Wrist Low Setting: .75 Meg Foot low Setting: .75 Meg
 Wrist high setting: 10 Meg Foot high Setting: 100 Meg

Action:

Wrist Low

Wrist strap is low. Check and try again.

Received: W=00.00M=LO, L=99.99M=--, R=99.99M=--,
 00.75M<W<10.00M, 00.75M<F<99.98M

Results

Wrist: **LOW** = 0 Meg
 Left foot: not used > 100 Meg Right foot: not used > 100 Meg

Cancel



Example of a high wrist reading:

My Company ESD PROTECTION TEST LOG

Press Button

Please plug in wrist strap
Step on foot plate

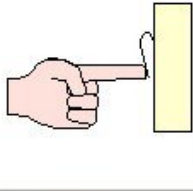
Press and hold the button

My Company ESD Protection Test Results

Operator Information

Operator's Name: Connery, Sean
 Date: 08-06-2003 Time: 22:47:09
 Wrist Strap: Required Foot Strap: not used
 Wrist Low Setting: .75 Meg Foot low Setting: .75 Meg
 Wrist high setting: 10 Meg Foot high Setting: 100 Meg

Action:

Wrist high

Wrist strap is high. Make sure it is connected and try again.

Received: W=99.99M=HI, L=99.99M=--, R=99.99M=--,
 00.75M<W<10.00M, 00.75M<F<99.98M

Results



Wrist: **HIGH** > 100 Meg
 Left foot: not used > 100 Meg Right foot: not used > 100 Meg

Cancel

Example of a multiple high readings:

My Company ESD PROTECTION TEST LOG

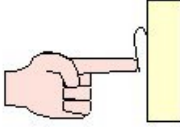
Press Button
Please plug in wrist strap
Step on foot plate
Press and hold the button

My Company ESD Protection Test Results

Operator Information

Operator's Name: Connery, Sean
Date: 08-06-2003 Time: 22:49:49
Wrist Strap: Required Foot Strap: Required
Wrist Low Setting: .75 Meg Foot low Setting: .75 Meg
Wrist high setting: 10 Meg Foot high Setting: 100 Meg

Action:

Multiple problems
Wrist is high. Left foot is high. Right foot is high.

Received: W=99.99M=HL, L=99.99M=--, R=99.99M=--,
00.75M<W<10.00M, 00.75M<F<99.98M

Results

Wrist: **HIGH** > 100 Meg
Left foot: **HIGH** > 100 Meg Right foot: **HIGH** > 100 Meg

Cancel

Example of a miscommunication reading caused by releasing the test button prematurely:

My Company ESD PROTECTION TEST LOG

Press Button
Please plug in wrist strap
Step on foot plate
Press and hold the button

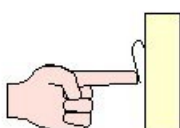

My Company ESD Protection Test Results

Operator Information

Operator's Name: Connery, Sean
Date: 08-06-2003 Time: 22:48:43
Wrist Strap: Required Foot Strap: not used
Wrist Low Setting: DipSw Foot low Setting: DipSw
Wrist high setting: DipSw Foot high Setting: DipSw

Action:

Communications failure
Communications failure. Try pressing the switch longer.

Received: W=00.00M=LO, L=99.99M=--

Results

Wrist: -
Left foot: - Right foot: -

Cancel

REPORT GENERATION:

There are eleven types of employee reports that can be generated from the ACL-750 software: DAILY, MONTHLY, ENTIRE LOG, INDIVIDUAL LOG, INDIVIDUAL ATTENDANCE, EXCEPTIONS, TWICE TESTED EXCEPTIONS, MONTHLY VACATION, CERTIFICATION EXPIRATION, TRAINING, UPDATE (updates or removes employees who are no longer in the remote corporate data base), and AUTOGENERATE EMAIL

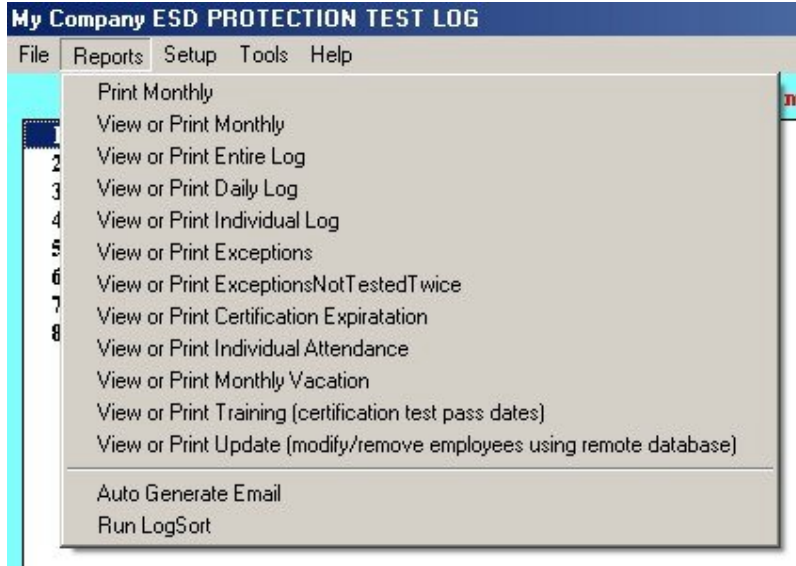

Each of these reports will interpret information collected from employee testing.
PRINTER DRIVER SOFTWARE MUST BE INSTALLED TO PRINT REPORTS.

Monthly report

Below is an example of the Monthly report. A monthly report can be generated, displayed, or printed at any time by pulling down the Reports menu and selecting "Monthly". The information presented includes. Person, ID number, department number, date, time, value in ohms of the test. The file REPORT.TXT may be imported into other applications (see below). A FONT size of 7.5 was recommended in order to print a full month on a standard size of paper.

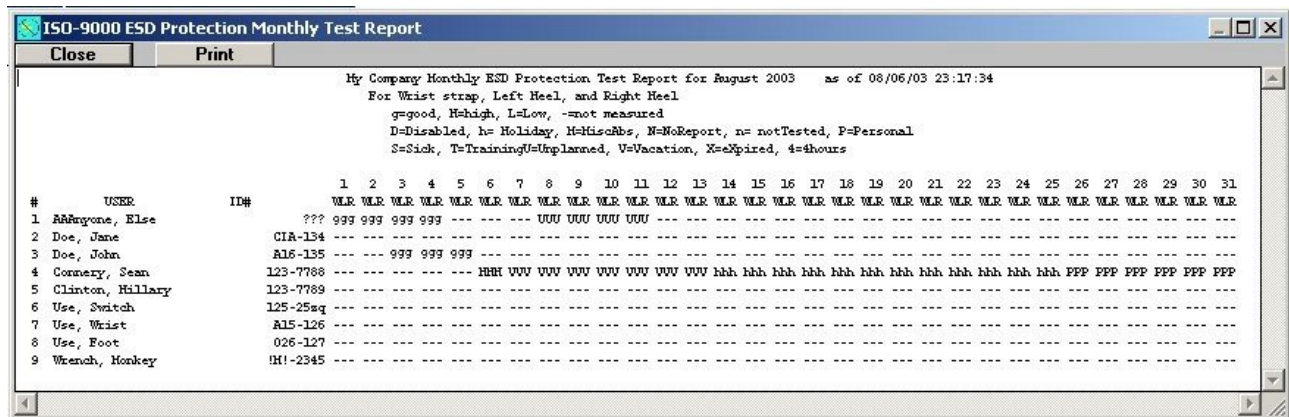

Entire Log report

Below is an example of the Test Log Report. The log file LOG.TXT may be viewed by selecting the 'View Log' item in the 'Report Menu'. This file is a comma separated value (.CSV) text file and may be imported directly into any spreadsheet or data base program. To print only part of it, select the desired part to print with the mouse, and click the print button.

LastName	FirstName	ID#	Date	Time	WristStat	LeftStat	RightStat	WristMegs	LeftMegs	RightMegs
Stat key: ok=in range, hi=resistance too high, lo=resistance too low, -=not used										
Date is in mm-dd-yyyy format										
Doe, Jane		CIA-123	09-04-2000	23:42:35	Wok, Lhi, Rhi			06.40	100.00	100.00
Use, Wrist		R15-126	09-04-2000	23:43:02	Wok, L-, R-			02.72	-	-
Connery, Sean		123-7788	08-06-2003	22:45:26	Wok, L-, R-			02.47	-	-
Connery, Sean		123-7788	08-06-2003	22:46:08	ComFail, *	*	*	*	*	*
Connery, Sean		123-7788	08-06-2003	22:46:11	Wok, L-, R-			01.38	-	-
Connery, Sean		123-7788	08-06-2003	22:47:11	Whi, L-, R-			100.00	-	-
Connery, Sean		123-7788	08-06-2003	22:47:57	Wlo, L-, R-			0.00	-	-
Connery, Sean		123-7788	08-06-2003	22:48:47	ComFail, *	*	*	*	*	*
Connery, Sean		123-7788	08-06-2003	22:49:59	Whi, Lhi, Rhi			100.00	100.00	100.00

Daily report

Below is an example of the daily report, which can show the daily test result for all employees, or a particular workgroup of employees.

LastName	FirstName	ID#	Date	Time	WristStat	LeftStat	RightStat	WristR	LeftR	RightR	Station	GmtDiff	Exit date	Exit time
ISO-9000 ESD Protection Daily Log Report MyCompany Inc as of 2/25/2009 12:49:20														
Stat key: ok=in range, hi=resistance too high, lo=resistance too low, -=not used														
Smith, Paul		GIA-12321A	7/31/2008	15:49:13	Whi, Lhi, Rhi			100.00	100.00	100.00	R05	-5	-	-
Smith, Paul		GIA-12321A	7/31/2008	15:49:21	Whi, Lhi, Rhi			100.00	100.00	100.00	R05	-5	-	-
Smith, Paul		GIA-12321A	7/31/2008	15:49:28	Whi, Lhi, Rhi			100.00	100.00	100.00	R05	-5	-	-
Smith, Paul		GIA-12321A	7/31/2008	15:49:41	Whi, Lhi, Rhi			100.00	100.00	100.00	R05	-5	-	-
Smith, Paul		GIA-12321A	7/31/2008	15:49:47	Whi, Lhi, Rhi			100.00	100.00	100.00	R05	-5	7/31/2008	15:54:59
Smyth, Joe		GR2-3212z	7/31/2008	15:50:11	W-, Lhi, Rhi			-	100.00	100.00	R05	-5	-	-
Smyth, Joe		GR2-3212z	7/31/2008	15:55:34	W-, Lhi, Rhi			-	100.00	100.00	F01	-5	7/31/2008	16:00:28
Smith, Paul		GIA-12321A	7/31/2008	15:58:51	Whi, Lhi, Rhi			100.00	100.00	100.00	F01	-5	7/31/2008	16:01:21
Smith, Paul		GIA-12321A	7/31/2008	16:01:44	Whi, Lhi, Rhi			100.00	100.00	100.00	F01	-5	7/31/2008	16:02:13
Smith, Paul		GIA-12321A	7/31/2008	16:02:59	Com, *	*	*	*	*	*	F01	-5	7/31/2008	16:03:21
Smith, Paul		GIA-12321A	7/31/2008	16:04:22	Whi, Lhi, Rhi			100.00	100.00	100.00	F01	-5	-	-
Smith, Paul		GIA-12321A	7/31/2008	16:06:15	Whi, Lhi, Rhi			100.00	100.00	100.00	F01	-5	-	-
Smith, Paul		GIA-12321A	7/31/2008	16:14:12	Whi, Lhi, Rhi			100.00	100.00	100.00	F01	-5	8/21/2008	18:42:16

Individual test log report

Below is an example of the individual log, which can show the test results for any or all employees for any day or group of days.

LastName	FirstName	ID#	Date	Time	WristStat	LeftStat	RightStat	WristHegs	LeftHegs	RightHegs
Stat key: ok=in range, hi=resistance too high, lo=resistance too low, -=not used										
Connery, Sean		123-7788	08/06/03	22:45:26	Wok, L-, R-			02.47	-	-
Connery, Sean		123-7788	08/06/03	22:46:08	Com, *	*	*	*	*	*
Connery, Sean		123-7788	08/06/03	22:46:11	Wok, L-, R-			01.38	-	-
Connery, Sean		123-7788	08/06/03	22:47:11	Whi, L-, R-			100.00	-	-
Connery, Sean		123-7788	08/06/03	22:47:57	Wlo, L-, R-			0.00	-	-
Connery, Sean		123-7788	08/06/03	22:48:47	Com, *	*	*	*	*	*
Connery, Sean		123-7788	08/06/03	22:49:59	Whi, Lhi, Rhi			100.00	100.00	100.00

Exceptions report

Below is an example of the exceptions report. A daily failure exception report may be generated and displayed or printed at any time by pulling down the Reports menu and selecting "Exception". The file EXCEPT.TXT may be imported into other applications (see below). The password and workgroup designator features (see Report Generation Paragraph 1 above) apply. Note that the last reading of the day is the one that is reported for the day. An SSS will be shown for sick leave, a VVV will be shown for vacation leave, and a TTT will be shown for training leave. Other codes include Other buttons include: HHH for Holiday, 444 for 4hours, DDD for Disabled, MMM for MiscAbs, NNN for NoReport, and UUU for Unplanned. An x will be shown for a failure, and a - will be shown for a possible failure if the wrist or foot mode has not been selected.

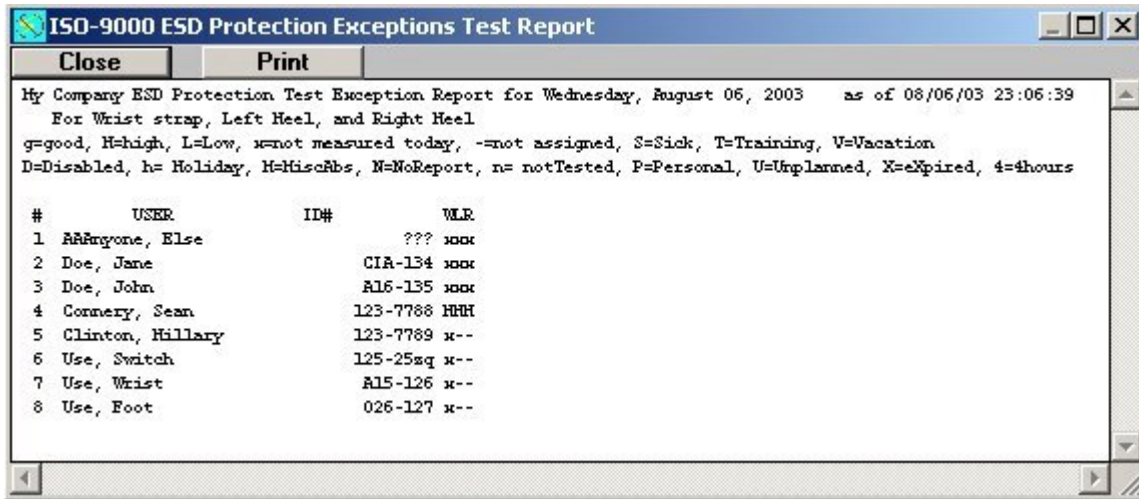

The report can be formatted by double clicking on the Except.csv report file and then double clicking on the Exceptions.xls formatting file. You can easily modify the company name, headers, language, and statistics.

	A	B	C	D	E	F	G	H
1		EsdTest® Report	MyCompany	Employee Exception report				
2			as of 1/15/2007 22:59:36					
3								
4	#	Name		Work	ID	wrist	left foot	right foot
5		Last	First	Group	#	status	status	status
6								
7	1	Smith	Will	FBI	654	Vacation	Vacation	Vacation
8	2	Loe	Jane	CIA	134	FAILED HIGH***	FAILED HIGH***	FAILED HIGH***
9	3	Doe	John	A16	135	NOT TESTED***	NOT TESTED***	NOT TESTED***
10	4	Connery	Sean	HSS	1007	NOT TESTED***		

Twice Tested Exceptions report

Below is an example of the twice tested exceptions report. Since ISO-9000 requires testing before and after meal breaks, this report will list employees who have not tested twice with 12 hours of generating this report. The employees must have tested twice with a three hour or more interval between tests to pass.

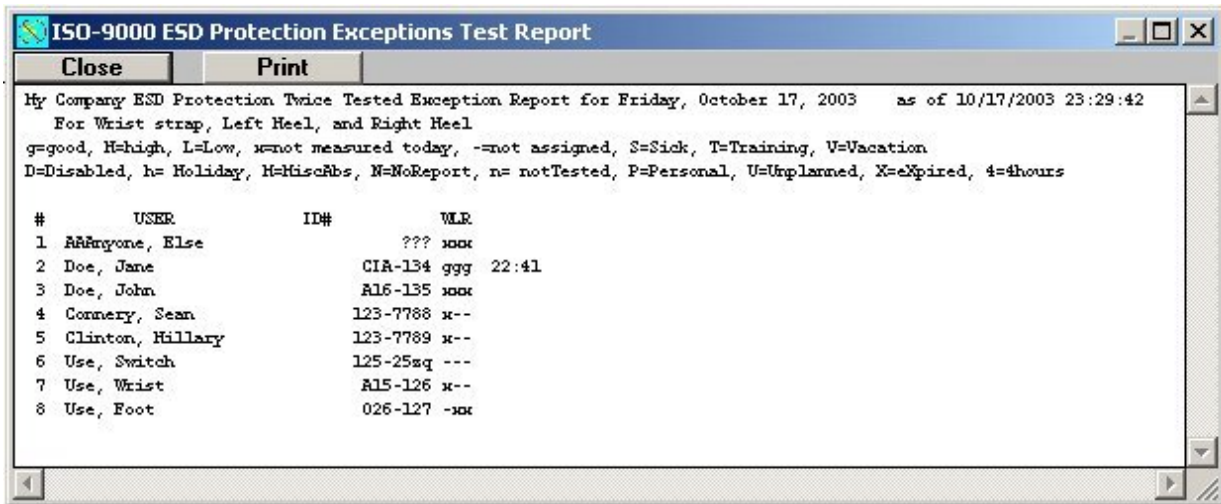

Certification Expiration report

Below is an example of the certification expiration report. A certification expiration report may be generated and displayed or printed at any time by pulling down the Reports menu and selecting "Certification Expiration". The file CERTIF.TXT may be imported into other applications (see below). The password, workgroup designator, and individual selection features (see Report Generation Paragraph 1 above) apply. To see a report of which employee's certification will expire at the end of the month, enter the date for the end of the month. To see a report of all employees certification types and expiration dates, enter a date that is greater than the highest expiration date.

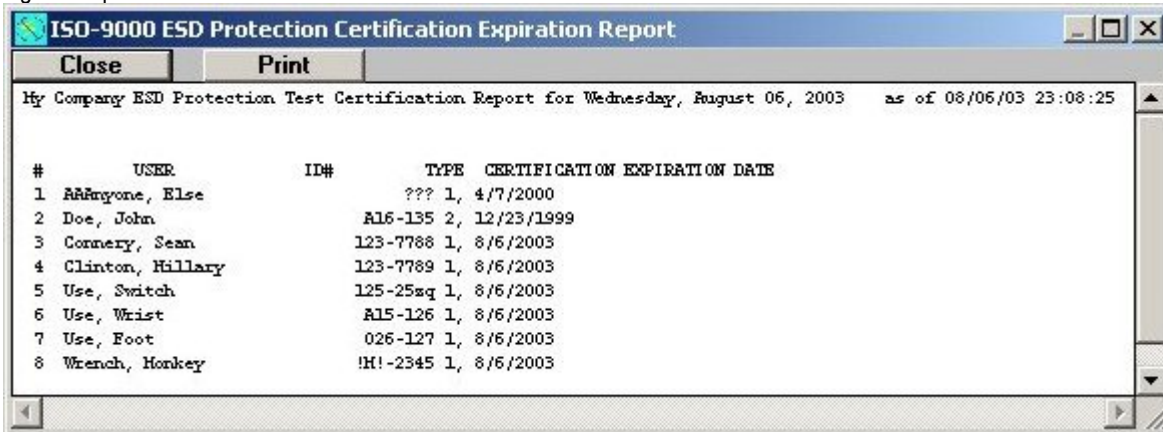

Individual Attendance report

Below is an example of the individual attendance report, which will display the yearly attendance record for any individual.

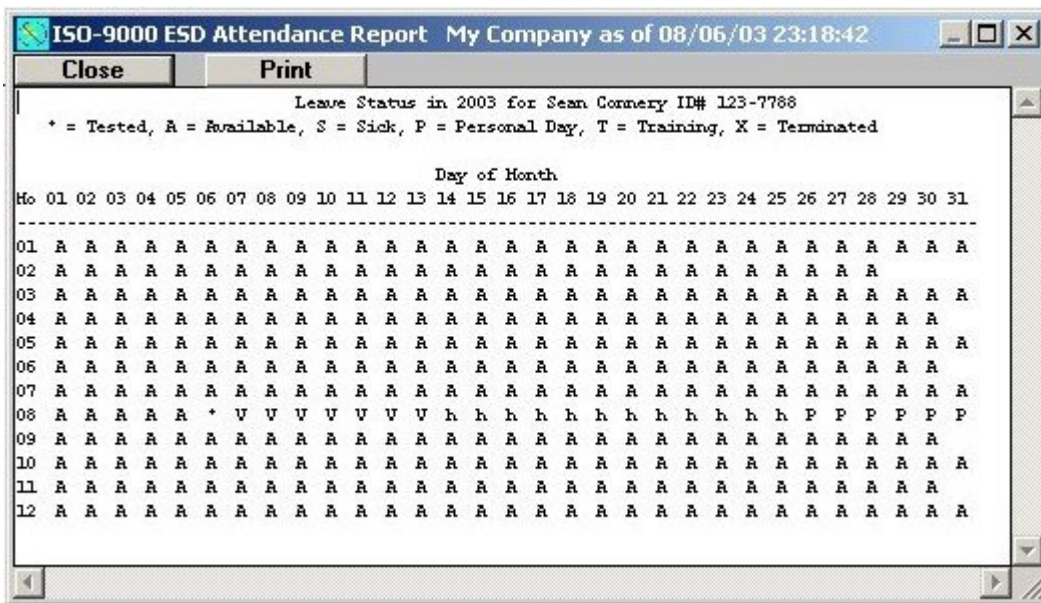

Monthly Vacation (Attendance) report

Below is an example of the monthly vacation report, which will generate an attendance report for all employees, a work group of employees, or an individual employee.

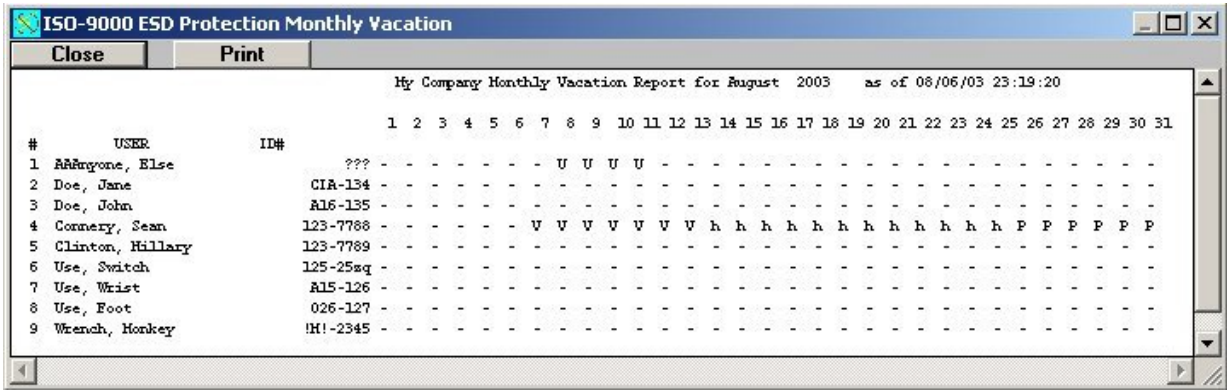

Automatic Emailed Reports

A unique feature of the ACL-750 meter allows users to enable the automatic generation of a report to be sent directly to a supervisor. This requires a MAPI compliant email program such as Microsoft Outlook Express or Microsoft Outlook (without the email security update). Click On Reports, Auto Generate Email

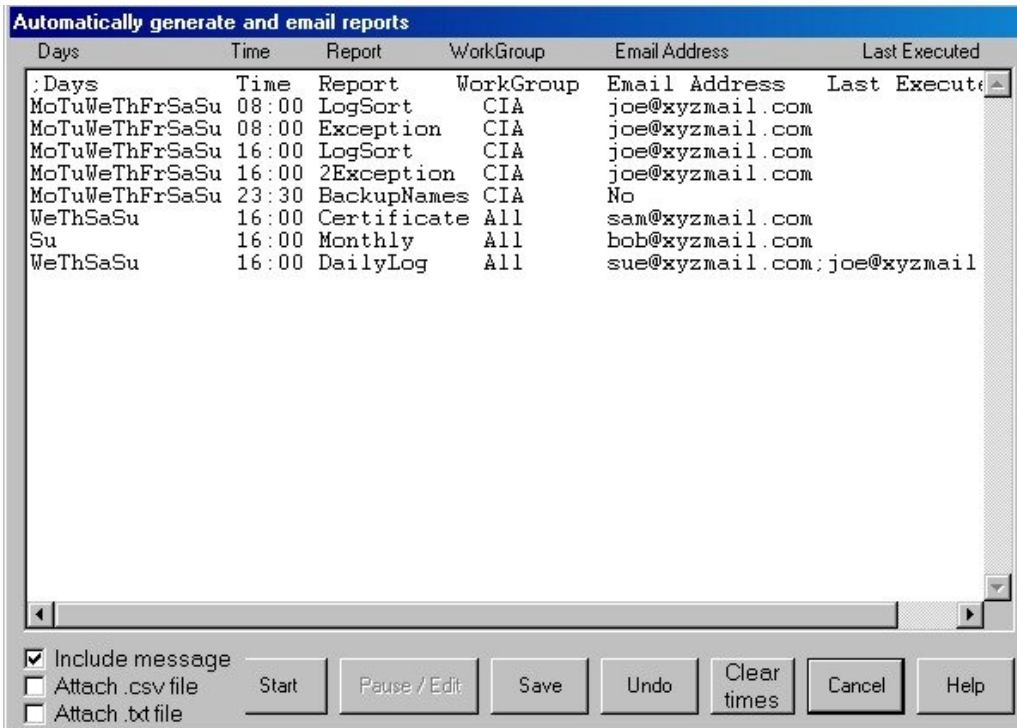

Automatic report generation help (This is also displayed when clicking on the help button)

Fill out the main text window with the times, reports, workgroups, and email addresses to be sent. The standard copy (Ctrl Insert) and paste (Shift Insert) shortcuts can be used to fill out the text window. Separate the fields with spaces, not tabs.

An example of filling out the main text box is shown below:

```
;Days      Time  Report      WorkGroup  Email Address      Last Executed
MoTuWeThFrSaSu  00:00 LogSort      CIA         joe@xyzmail.com
MoTuWeThFrSaSu  00:00 Exception    CIA;CIB     moe@xyzmail.com;tim@xyzmail.com
WeThSaSu        15:05 Certificate  All         sam@xyzmail.com
Su               15:06 Monthly    All         bob@xyzmail.com
WeThSaSu        15:07 DailyLog    All         sue@xyzmail.com
WeThSaSu        15:10 GetNames    All         NO
WeThSaSu        15:10 SendNames   All         NO
```

Any line beginning with a semicolon will be ignored as a comment.

Possible entries for Days:

MoTuWeThFrSaSu (one or more of)

La (Last day of month)

Fi (First day of month)

Possible entries for Time:

01:23 (hour in 24 hr format : minute)

Possible entries for report:

LogSort (Lo)	Combines the log.txt files from the test stations and sorts them
Exception (Ex)	Report of employees who have not passed the test
2Exception (2E)	Report of employees who have not tested before and after a break
Certification (Ce)	Report of the status of the employee training certifications
Daily (Da)	Report of the daily test log
Monthly (Mo)	Report of tests summarized by month
GetNames (Ge)	Combines the name.txt files from the test stations
SendNames (Se)	Sends the server names.txt file to the test stations
BackupNames (Ba)	Backs up the names.txt file through 7 rotations
M1Task (M1)	Executes a custom batch program named M1.bat
M2Task (M2)	Executes a custom batch program named M2.bat
M3Task (M3)	Executes a custom batch program named M3.bat
M4Task (M4)	Executes a custom batch program named M4.bat
M5Task (M5)	Executes a custom batch program named M5.bat
Training (Tr)	Imports the training course status to the names.txt file
Update (Up)	Updates and deletes employee info from the names.txt file
Vacation (Va)	Report of employees sick and vacation schedules
DownloadLog (Do)	Imports the remote data base measurements to the log.txt file
NdownloadNames (Nd)	Imports the remote data base names info to the names.txt file
Occupancy (Oc)	Report of the employees who have not signed out

LogSort will read all the test stations (that are listed in the netlist.txt file) log.txt files and combine and sort them into one log.txt file on the server.

Exception will generate an exception report of workers who failed the test or did not test. The exception report will list employees that have not yet tested on that day (i.e since 00:00 AM of the day the report was run). To prevent second shift employees (who test at 4PM) from showing up on the 7AM exception report, assign them different workgroups (like SH1 and SH2) and run the 7AM exception report for the SH1 workgroup only, and run the 4PM exception report for the SH2 workgroup only.

2Exception will generate an exception report of workers who did not test twice within the last 12 hours. Tests must be separated by 3 hours or more.

Certification will generate a report of workers who's certification period has expired.

Daily will generate a report of test values for the day. If the "exit" feature is used, this will list both the test time and the exit time on the same line.

Monthly will generate the monthly summary report.

GetNames will read all the test stations' names.txt files and combine any newly added names into the server's names.txt file, and call BackupNames.

SendNames will send the names.txt file to the test stations listed in the netlist.txt file.

M1Task will launch (and execute what ever is in) your custom M1Task.bat file (such as copying report files from one computer to another), but will not wait for M1Task.bat to finish.

M2Task – M5Task will likewise execute M2Task.bat – M5Task.bat.

BackupNames will backup the names.txt data file through seven rotations, so call this once per day for a complete weekly backup. It will backup the names data file names.txt. It should be called once each day, It will: delete NamesBakRot7.txt, rename NamesBakRot6.txt to NamesBakRot7.txt, rename NamesBakRot5.txt to NamesBakRot6.txt, rename NamesBakRot1.txt to

NamesBakRot2.txt, and copy Names.txt to NamesBakRot1.txt. Thus you will have seven days to recover a names.txt file before it gets deleted. This function can be automatically called from the Autogenerate email task scheduler.

Training will read the optional Certification training course data files to see which employees have passed the retraining exam, and generate a report. Refer to the Help.txt file Installation step 30 on how to Setup Certification Configuration.

Update will update employees that are in the names.txt data base with the latest info in the remote data base, and remove employees that are not in a remote data base from the names.txt file, and email a report showing the names that were removed. The remote data base settings are in the Setup Remote data base window.

DownloadLog will imports the remote data base measurements to the log.txt file. WARNING – all previous data in the log.txt file will be overwritten

NdownloadNames imports the remote data base names info to the names.txt file. WARNING – all previous data in the names.txt file will be overwritten

Occupancy will generate a report of the employees who have conducted a test, but not signed out (i.e. not scanned their badge on the way out without pressing the test button).

Possible entries for Workgroup:

any legitimate predefined workgroup designator

any concatenation of the other predefined workgroup designators with semicolons but no spaces

e.g. CIA;CIB;CIC

the word ALL - will use all workgroups

Possible entries for Email addresses:

any legitimate email address e.g. joe@xyzmail.com

any concatenation of email addresses using a semicolon but no spaces

e.g. joe@xyzmail.com;moe@xyzmail.com

the word NO (or any word less than 4 letters) to generate a report but not email it

Possible entries for Last Executed:

the program will fill this in when the report is run

Delete the entry or leave it blank to run the report today.

Other Notes:

There are three check boxes at the bottom of the window:

Check the one labeled "Include Message" to include the report in the email message body

Check the one labeled "Attach .txt file to attach the report as a .txt file

Check the one labeled "Attach .csv file to attach the report as a .csv file

Note that at least one of these must be checked or the default will be the message body with the .csv file attached.

the email security update). Outlook 2002 requires administrator security overrides. The email messages will be placed in the Outlook Express outbox. Set up Outlook Express to automatically send the email outbox every 10 minutes or so.

If while generating reports to email, Outlook Express 6 generates a warning message saying "An application is attempting to send email in your name", then disable the messages by opening Outlook Express, clicking Tools, Options, Security, Virus Protection, and uncheck the box that says "Warn me if other applications try to send mail as me."

Microsoft recently added major security updates to Outlook 2002 which prevents other programs (such as EsdTest) from using it to send MAPI email messages without popping up a warning message "A program is automatically trying to send email on your behalf."

Thus if your company is using Microsoft Outlook 2002 with Microsoft the Exchange Server, then only the administrator is able to set up a public Outlook security folder to disable the warnings (see the Microsoft Knowledge Base Article # 263297 on the www.microsoft.com website). The alternative is to switch to either Outlook Express (which is not fully compliant with Microsoft Exchange) or Outlook 2000 without the email security update.

Troubleshooting:

If you do not receive a report please:

1. Check in the server Outlook Express Outbox Sent box and see if got sent. If it did get sent, then the problem may be in your spam filter or your company's email server.
2. If it is not in the Sent box, see if it is in the Out box, in which case your company's SMTP server had a problem sending it.
3. If it is not in the Out box then make sure the Autogenerate window is still open and that the Start button is grayed out - meaning that the report program is still running, and no one accidentally shut it off. Accidental shutoff can be prevented in program versions 6.72 and later by activating the EsdTest administrator password.
4. If no one shut the program off, then check the Last Executed column in the Autogenerate window and see when the last report was sent. If the last report was sent at the scheduled time, then there is a problem with your MAPI mail programs on your server - try rebooting.
5. If the last report executed did not execute at the scheduled time, check the server's computer clock and date setting. Move the mouse to the lower right of the screen and right click on the time, and then choose Adjust Time/Date to see the date.
6. If the date is correct, then click the Pause/Edit button in the Autogenerate window, and then click the Start button again. Make sure that the scheduled report information looks OK, especially the top line, and that the file has not been corrupted, and that the format looks the same as the examples above. Also check the Last Executed column to make sure no dates in the future have been inserted.

File backups:

GetNames (but not SendNames) will automatically backup the new combined names.txt file whenever it is run, on a 2 run rotation. It will backup Namesbak1.txt to Namesbak2.txt then backup Names.txt to Namesbak1.txt, so you will need to catch it within 2 executions before the backups are totally overwritten.

If you want a longer rotation, our AutoGen Report scheduler has the capability of running your own custom .bat files, so you can run any rotation schedule or to any computer you desire.

For example, to backup the names.txt file once per day on a 7 day rotation you could write a file named M1Task.bat as follows

```
xcopy namesB6.txt namesB7.txt /Y /C
xcopy namesB5.txt namesB6.txt /Y /C
xcopy namesB4.txt namesB5.txt /Y /C
xcopy namesB3.txt namesB4.txt /Y /C
xcopy namesB2.txt namesB3.txt /Y /C
xcopy namesB1.txt namesB2.txt /Y /C
xcopy names.txt namesB1.txt /Y /C
```

(might have to specify path if default path is different, i.e.)
xcopy c:\EsdTest\names.txt c:\EsdTest\namesB1.txt /Y /C

The /Y and /C prevent the xcopy command from stopping on errors. Place the M1Task.bat file in the same directory as the EsdTest.exe file, which is usually the c:\EsdTest directory.

and insert the following line into the AutoGenerate Task scheduler:

```
MoTuWeThFrSaSu 06:00 M1Task all no
```

In addition, you could even do a 4 week rotation by the following lines to a file named M2Task.bat:

```
xcopy namesW3.txt namesW4.txt /Y /C
xcopy namesW2.txt namesW3.txt /Y /C
xcopy namesW1.txt namesW2.txt /Y /C
xcopy names.txt namesW1.txt /Y /C
```

and insert the following line into the AutoGenerate Task scheduler:

```
Fr 06:05 M2Task all no
```

LogSort Notes

LogSort is only needed if the test stations are using their local log.txt data bases to store their data.

LogSort should not be run if the test stations are directly storing their data on the server log.txt file.

If LogSort is run, it should be from the server computer.

Selecting LogSort as a report will backup and combine the test station log.txt files. It will:

- a. Rotate the backup logbak1.txt file to logbak2.txt.
- b. Rotate the log.txt file to logbak1.txt.
- c. Append (and sort if needed) the test station Log.txt files to the server Log.txt file.
- d. Append each users Log.txt file to its own LogHist.txt file.
- e. Delete each users Log.txt file.

Errors will be ignored. To see errors, run the Logsort.exe program directly from Explorer.

The LogSort.exe program will combine the data from four workstations I:, J:, K:, and L:. For other drives or network computers, place the complete file path on a line in the NetList.txt file.

Thus the Netlist.txt file will look something like:

```
\\teststation1\EsdTest  
\\teststation2\EsdTest  
\\teststation3\EsdTest  
\\teststation4\EsdTest
```

or for some operating setups may look like:

```
\\teststation1\c:\EsdTest  
\\teststation2\c:\EsdTest  
\\teststation3\c:\EsdTest  
\\teststation4\c:\EsdTest
```

If the Log.txt, LogBak1.txt, and LogBak2.txt files grow too large, then

- a. delete the Logbak1.txt file
- b. delete the LogBak2.txt file
- c. backup the Log.txt file to an external disk or tape drive if desired
- d. either delete the Log.txt file, or use a text editor to remove the old unwanted data.

The Log.txt file should be reset periodically to prevent it from growing so huge that it slows down report processing. Click on "Tools" and then select the "Reset Log File" item. It will ask for a backup file name.

For very large companies, it may be desirable to backup the log.txt file to a monthly backup file (for example Log0699.txt for June 1999). For small companies, this should be done at least once per year on January 1st.

Every January 1st, the LogHist.txt on the test station computers should also be deleted.

If while generating reports to email, Outlook Express 6 generates a warning message saying "An application is attempting to send email in your name", then disable the messages by opening Outlook Express, clicking Tools, Options, Security, Virus Protection, and uncheck the box that says "Warn me if other applications try to send mail as me."

There are three check boxes at the bottom of the window:

Check the one labeled "Include Message" to include the report in the email message body

Check the one labeled "Attach .txt file to attach the report as a .txt file

Check the one labeled "Attach .csv file to attach the report as a .csv file

Note that at least one of these must be checked or the default will be the message body with the ,csv file attached.

"A program is automatically trying to send email on your behalf."

For Microsoft Outlook Email security issues see Microsoft Knowledge Base Article - 263297

<http://support.microsoft.com/kb/263297#PF>

TOOLS

From the main window select tools

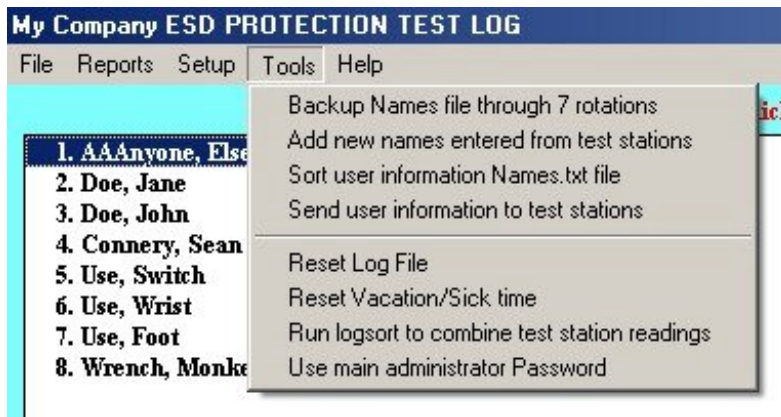

Tools menu

1. Backup Names file through seven rotations will backup the names data file names.txt. It should be called once each day, or set up to automatically called from the Autogenerate email task scheduler. It will: delete NamesBakRot7.txt, rename NamesBakRot6.txt to NamesBakRot7.txt, rename NamesBakRot5.txt to NamesBakRot6.txt, rename NamesBakRot1.txt to NamesBakRot2.txt, and copy Names.txt to NamesBakRot1.txt. Thus you will have seven days to recover a names.txt file before it gets deleted. Add new names entered from test stations will read the netlist.txt file to find the test station paths, and read the test station names.txt file and add those names to the server names.txt file (can only be called from the server).
2. Sort user information will sort the employee names in the names.txt file, and check for duplicates.

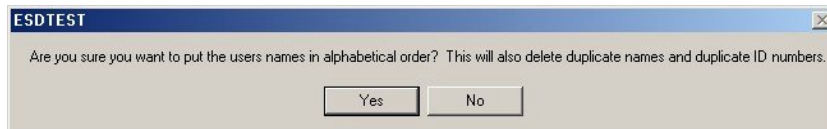

3. Send user information to test stations will copy the names.txt file back out to the test stations listed in the netlist.txt file
4. To reset the main log file (log.txt), or copy it to a backup file, select the Reset Log File item in the Tools menu. This will prompt for a backup file name to copy the file to before it resets (deletes) the log file. The log.txt file should be reset annually every January 1st.



5. To reset the sick/vacation attendance data, select the Reset vacation/sick time menu item in the tools menu. The attendance data must be reset annually every January 1st, otherwise the report generation will use the previous years data stored in the names.txt file.

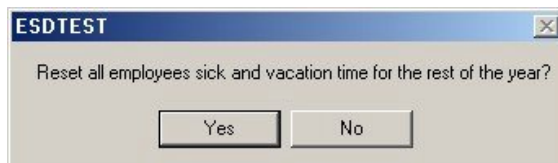

6. "Run log sort to combine test station readings" will combine the test station reading data if using the local data file method (see below).

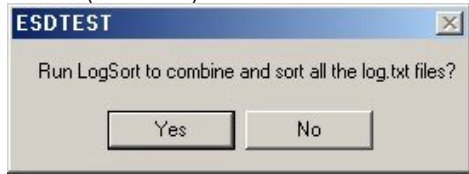

This function can also be accessed from the Reports menu, or run automatically from the AutoGenerate email task scheduler.

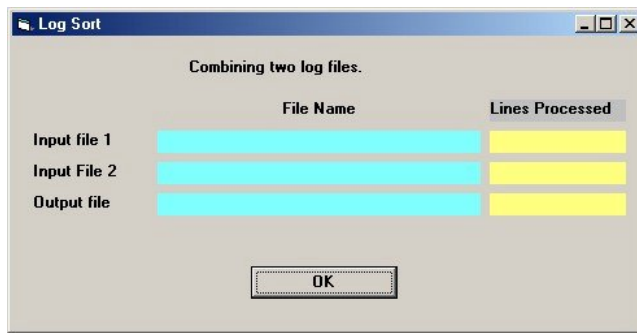

7. "Use main administrator password" will force the administrator password (if one exists) to be used. This is always required to be used to access any setup information after booting up, but is not required once the administrator has entered the password., unless the password expiration time (set in the General configuration window) has been set and exceeded.

ADVANCED FEATURE SETUP

NETWORKING THE ACL-750 TESTER

The average network installation will have 1-5 test station computers, and a server. The server may also be used as a test station, but this not recommended in high use applications. There are three methods of networking.

Method 1 (Simple) is to have the test stations all use the common server data base. This method is easy to set up and understand. The disadvantages are:

- the same ones that all common data base applications have – the test stations will not work if the server or network goes down.
- increased network usage since each test must access the data files over the network
- decreased server security since the server directory must grant access and sharing rights to all the test stations

Method 2 (Robust) is to have the test stations all use local data bases (i.e. data files stored on their own computer) so they can run independently of the network. The server then periodically reads and resets the local data base logs using a routine called LogSort.

Method 3 (Customer's data base) is only used if the customer wishes to write his own report and maintenance routines using his existing SQL data base, and not use the EsdTest server functions. See the "Remote data base" section of this manual.

Method 1 (Simple) – using one common data base for all test stations

At each test station, click Setup, Directories, and in the top two lines, enter the file path where the common data base will reside. For example, if the common data base files (log.txt and names.txt) reside on the server computer, and if the server computer is named EsdTestServer, then enter [\\EsdTestServer\c:EsdTest](#) in the top two lines. To check the path, open Windows Explorer Network Neighborhood and locate the log.txt file on the server. Double click it to open the file with Notepad, which will check that the test station has the proper sharing rights. Close the log.txt file. Be sure to use the exact path name that is displayed in Windows Explorer.

Note - when running the Auto Email reports on the server, ignore all references to LogSort, GetNames, and SendNames since they only pertain to method 2 below.

Method 2 (Robust)– using local data bases at each test station

All execution files (ESDTest.exe) and data files (Log.txt, Names.txt,ESDTest.ini) are stored locally on the test station computer so that a network or server failure will not affect the test station operation. Each workstation can operate independently of the server. The server can be set up to be totally secure with no access or sharing required on it's drives, which ensures that employees can not tamper or corrupt the master data files. Setup the server to read the local test station log.txt files in the following manner:

Setup

A.) At the server, edit the Netlist.txt file (in the server EsdTest directory) using Notepad to point to the EsdTest directory of each test station:

[\\teststation1\c\EsdTest](#)

[\\teststation2\c\EsdTest](#)

[\\teststation3\c\EsdTest](#)

If your computer network does not allow accessing other computers this way, then but does allow drive remapping, then delete the NetList.txt file, and map drives I-L to the test station EsdTest directories.

B.) If desired, the remote test stations can automatically update their time clocks from the server by executing the Synch.bat file whenever a test is conducted. To do this, see the section below titled "Synchronizing Test Station System Time", which explains how to put the server name into the one line file. An easy way to edit Synch.bat is to locate the file in Windows Explorer (My Computer), right click on it, and select edit, which should open it with Notepad.

If a test station computer is out of time synchronization with another computer, the following can happen. Suppose Joe Employee fails a test at Station A, and then passes a test at Station B five minutes later. If Station B's time is six minutes slower than Station A, it will appear that Joe first passed the test and then failed the test, so he will show up on all the reports as failing.

C.) At each test station, click Setup, Directories, and make sure all the entry boxes are blank. This will ensure that the test station uses local data files.

Operation

Each test station contains a local copy of the master names.txt files, so that a user can be tested at any test station. If the user information is changed on the server master copy, all test stations will automatically read the new information whenever the new copy is downloaded into their local directory. To download the names.txt file to the test stations after it is modified on the server (such as when a new user is added), run the SendNames function in the Auto Email report generator on the server to automatically download them, or manually click Tools, "Send user information to test stations".)

The test data log file is named Log.txt, which stores one line of data every time a user tests. When it is desired to consolidate the remote test station data (e.g. before running a report), the server runs the LogSort function to read the data from the remote test station log.txt files, append the data to the local remote log history files called 'loghist.txt', resets the local log.txt file, and stores the data in the server log.txt file. The function also sorts all the data in chronological order.

The sequence of the server operation will thus look something like this:

1. Each day, the data from all the test stations should be gathered to produce a combined log.txt data file on the server for report generation. On the server, either manually click on Reports, Run LogSort; or run it automatically from the task scheduler in the AutoGenerate Email feature. The LogSort function will combine the data from the test stations listed in the NetList.txt file. If the NetList.txt file does not exist, the LogSort function will combine the data from the test stations mapped to the four drives I:, J:, K:, and L. The LogSort function will:
 - a. Rotate the backup the server logbak1.txt file to the server logbak2.txt file
 - b. Rotate the server log.txt file to the server logbak1.txt file
 - c. Append (and sort by time if needed) the test station Log.txt files to the server Log.txt file.
 - d. Append each test station's Log.txt file to the test station's LogHist.txt file.
 - e. Delete each test station's Log.txt file (which will be re-created after the next test).
2. The daily exception report can be generated from the from the server computer EsdTest program by clicking Reports, "View or Print Exception Report", (refer to Help.txt) or can be run automatically from the AutoGenerate Email feature.
3. Other reports can be generated such as the monthly report, for ISO9000 documentation
4. The Log.txt file should be reset periodically to prevent it from growing so large that it slows down report processing. Click "Tools" and select "Reset Log File". It will ask for a backup file name. Large companies should back up the log.txt file to a monthly backup file (for example Log0601 for June 2001). For small companies a back up should be done once every year.
5. If employees are permitted to enter their names when a badge is not recognized, then the individual tests station names.txt files may be consolidated into a master name.txt file. Run the GetNames and SendNames function from the server Auto Email window, or manually click the Tools "Add new names entered from Test Stations", "Sort names alphabetically", "Send names to test stations".

Test Station Computer Setup

1. It is recommended to use any Pentium type PC 166 MHz or greater, although even an old 486DX will work, running Windows 95 or higher (98 / NT / XP), with a 10/100base T RJ-45 type network card, 16MB or higher of ram, 1G disk or greater, and a spare serial port (9 pin preferred).
2. Connect all stations and the server to a central 10/100baseT Rj-45 type Ethernet hub using a star (parallel) arrangement with RJ-45 TPE (twisted pair Ethernet) or category 5 type cables.
3. Name the test stations something like TestStation1 (each station must have a unique name), and do not designate a password.
4. Install the ESDTest Software (see above).
5. If using the Network setup disks generated by the XP server (see Server Setup 1 below), then just run them. Otherwise, right click on the Network Neighborhood icon, select 'Properties', and check that Client for Microsoft Networks, network card driver software is present. On simple Windows 95 networks, also install NetBeui
6. Click 'File Sharing' (access to all files). Do this ONLY on test stations.
7. In Primary Network Logon select 'Client for Microsoft Networks', click the Identification tab
8. Type a computer name (like TestStation1)
9. Type the workgroup name (like ESDTestGroup). Do not use spaces.
10. Type a description (like ESDTestStation1)
11. Click OK
12. A message will pop up asking you to reboot the computer. Answer "No". Do not allow the computer to restart.
13. To boot up into the ESDTest program when power is applied to the computer, change the logon password in Setting, Control Panel, Passwords to 'no passwords'. Some operating systems may require using Microsoft "PowerToys" (available on their website) to bypass the Windows logon.
14. Copy the ESDTest shortcut and past it to the start-up directory, which is named something like: C:\Documents and Settings\All Users\Start Menu\Programs\Startup
15. Restart the computer
16. Through Explorer, right click on the 'c:ESDTest' directory, select 'sharing' and then select 'all files'.
17. Give it a unique name (like ESDTest1).
18. Do not set up a password to the Server station.
19. If using Network Method 1 (see Networking section above), open the ESDTest file, click Settings, Directory, and enter the full path of the server ESDTest directory in the top two lines of the Directories window..

Server Computer Setup

1. The easiest way to set up a network is the Network Wizard such as the one that comes with Microsoft Windows XP Pro.
2. Give the server name like 'Server1' and a password.
3. Install the ESDTest software (see above)
4. Right click on the Network Neighborhood icon
5. Select properties, check that Client for Microsoft, network card driver software is present. On simple Windows 95 networks, also select NetBeui.
6. Do not click file sharing unless using the Method 1 networking (see Networking section above).
7. In primary Network Logon select Client for Microsoft Networks and click the Identification tab.
8. Type a unique name (like Server1)
9. Type the workgroup name (like ESDTestGroup)-do NOT use spaces
10. Type the description Main Sever and click OK.
11. Do not allow the computer to restart.
12. To remove the logon password, go to Setting, Control Panel, User. Some operating systems may require using Microsoft "PowerToys" (available on their website) to bypass the Windows logon.
13. Restart the computer
14. The 4 test stations should be visible in Windows Explorer Network Neighborhood.
15. Edit the NetList.txt file to include all the test stations if using networking Method 2 (see Networking section above).

Synchronizing Test Station System Time

To maintain the most accurate test results, it is imperative that all networked computer have the same time set.

1. Edit the Synch.bat file in the \ESDTest directory (if the Synch.bat file does not exist, rename the example SynchNet.bat file to Synch.bat.

2. Place the server name in the NET TIME line:
NET TIME \\XYZ /SET /YES *XYZ is the server name
3. Save the file
4. Right click on the Synch.bat file , click Properties, and select Close On Exit.
5. If the SYNCH.BAT file already exists in the directory, but the program leaves a small 'Finished' box on the toolbar when it is called, click the Properties box on the Synch.bat file item in Explorer and click the 'Close on Exit' box.
6. The SYNCH.BAT file is included in the installation disk. If no network is used or the time synchronization is not desired, delete or rename the SYNCH.BAT file.

EsdTest File Administration

1. Install and configure the computer hardware (see above)
2. Set up the network. Make sure the test stations and their files are visible on Windows Explorer.
3. If polling the station data bases then put the test station computer names into the NetList.txt file. If running from one master data base, then set up the test station "Setup Directories Window" to point to the server data directory.
4. Set up the server AutoGenerate email task scheduler to poll the stations for data and send reports
5. The supervisor checks his emailed exception report to see if any employees have failed or did not test.
6. The supervisor can modify the sick leave/vacation status, generate monthly reports, delete any employees that are no longer working at the firm, and can reset the log.txt file to create a back up.
7. To access the master file from a remote manager's computer, set up the "Setup Directories Window" to point to the server data directory.

INTERFACING WITH OTHER DATA BASES

To be universally compatible with all other databases, spreadsheets, and word processors, the data is stored in a text file named Log.txt. Each record (row) is the results of one test, including the employee's name, ID, test date, test time, test results, and resistance values. Each of these fields is separated by a comma, so the file is actually in .CSV (Comma Separated Value) format. Importing and exporting to common databases is explained below.

The software can directly read the employee names from a company data base – see accessing names from a remote data base in the setup section.

Importing Log files to Excel:

1. To import monthly report files REPORT.TXT into Excel 5.0:
 - a. Run Excel
 - b. Open REPORT.TXT file
2. To import the file LOG.TXT into Excel 5.0:
 - a. Run Excel
 - b. Open LOG.TXT file
 - c. Text Import Wizard should appear. Choose Delimited
 - d. Click on Next
 - e. Choose Comma
 - f. Click on Finish

For older versions of Excel copy LOG.TXT file to LOG.CSV and open file.
See the help file for more aid in importing instructions.

Exporting Name.txt file from Excel:

Open a Names.txt file with a word processor just to see what a typical file looks like. It contains name, id, resistance limits, certification expiration dates, and attendance records. However, the only fields required in the Names.txt file are in the first 3 fields- LastName, FirstName, ID. Any missing fields after this will be filled in with default values. The first field (i.e. the first column in Excel) is the Last Name field.

The second field (i.e. the 2nd column in Excel is the First Name field. The combined length of the first and last name field should be less than 17 characters for best report formatting.

The third field (i.e. 3rd column in Excel) should be a combined workgroup-ID: badge number field. It should look like www-iiiiiiiiii:bbbb where www is the 3 character work group designator, iiiiii is the id code (12 char max.) , and bbbbbb is the badge code (12 char. Max.) Save the Excel file as a .csv (Comma Separated Values) file.

The other fields do not need to be filled in if the EsdTest default values are acceptable. Otherwise they may be filled in using Excel. The complete list of fields is: Field 1 – Last name, Field 2 – First name, Field 3 – Group-ID:Badge, Field 4 – Wrist min, Field 5 – Wrist max, Field 6 – Foot min, Field 7 – Foot max, Field 8 – Wrist enabled (-1 = yes, 0 no), Field 9 – Foot enabled, Field 10 – Leave status, Field 11 – Start date, Field 12 – Stop date, Field 13 – Certification type, Field 14 – Certification expiration, Field 15 – string of 365 attendance characters.

See the example file - HowToGenerateNamesFile.xls

Export this data as a .csv file and then rename it back to Names.txt.

Importing Files To Microsoft Access:

The Names.txt and Log.txt files are .csv (comma separated values) delimited files. The exception.csv and report.csv are also .csv files. Users can easily import these into Access using the File import method.

To import or link a delimited or fixed-width text file: NOTE: Users can link a table only in a Microsoft Access database, not a Microsoft Access project. IMPORTANT: Before a user import or link data from a delimited text file or fixed-width text file, make sure that the file has the same type of data in each field and the same fields in every row.

Open a database, or switch to the Database window for the open database.

To import data, on the file menu, point to Get External Data, and then click Import. To link data, on the File menu, point to Get External Data, and then click Link Tables. In the Import (or Link) dialog box, in the Files of Type box, select Text Files (*.txt, *.csv, *.tab, *.asc). Click the arrow to the right of the Look In box, select the drive and folder where the file is located, and then double-click its icon. IMPORTANT: if you link to a file on a local area network, make sure that you use a universal naming convention (UNC) path, instead of relying on the drive letter of a mapped network drive in Windows Explorer. A drive letter can vary on a computer, or it may not always be defined; whereas, a UNC path is a reliable and consistent way for Microsoft Access to locate the data source that contains the linked table.

Follow the directions in the Import Text Wizard dialog boxes. Click Advanced to create or use an import/export specification. Although you usually create a new table in Microsoft Access for the data, you can append the data to an existing table as long as the first row of your text file contains matching field names. If importing a text file takes an unexpectedly long time, it might be because many errors are occurring. To cancel importing, press CNRL+BREAK. In a fixed-width text file, you can ignore fields at the end of a record that contain no data. In addition, the last field with data in the record can be less than the maximum width.

Exporting the Names.txt File From Microsoft Access:

In the database window, click the name of the table, query, view or stored procedure you want to export, and then on the File menu, click Export. In the Save As Type box, click Text Files (*.txt, *.csv, *.tab, *.asc). Click the arrow to the right of the Save In box and select the drive or folder to export to. In the File Name box, enter the file name

(Names.csv), and then click Save All. Microsoft Access starts the Export Text Wizard. Follow the directions in the dialog boxes. Click Advanced to create or use an

Import/export specification. Save this as a .csv file (Comma Separated Values File), use commas to separate the fields. When done, rename the file to Names.txt.

The following are the field names:

Field 1 – Last name, Field 2 – First name, Field 3 – Group-ID:Badge, Field 4 – Wrist min, Field 5 – Wrist max, Field 6 – Foot min, Field 7 – Foot max, Field 8 – Wrist enabled (-1 = yes, 0 no), Field 9 – Foot enabled, Field 10 – Leave status, Field 11 – Start date, Field 12 – Stop date, Field 13 – Certification type, Field 14 – Certification expiration, Field 15 – string of 365 attendance characters.

For additional information see the help files in Microsoft Access.

Reading the Employee Names Directly From the Company Data base

See the section above on Remote Data Base Setup

SPECIFICATIONS:

Testing Range: 10^4 - 10^8 ohms. (10^9 ohms optional and can be specially ordered)

High Range: 2M, 5M, 10M, 25M, 35M, 50M, 75 M, 100M ohms. (1000M can be specially ordered)

Low Range: 500k, 750k ohms.

Display: Red, yellow and green LED buzzer

Accuracy: +/- 10% for the standard 100M meter, and +/- 20% for the 1000M meter

Weight: approx 1.0 lb. (454 grams) Meter alone with battery

Battery type/Life: typically over 20,000 measurements with a 9-volt alkaline battery

Continuous power may be run with an external 9-15 VDC power supply.
(Remove battery before running with an external power supply).

CE listed

NIST certificate included

Environment: 32°F to 100°F (0°C to 38°C); 15% to 95% RH.

Stand: Powder coated industrial grade steel. Color: Black

Footplate: heavy-duty board with plastic laminate and two stainless steel plates

MAINTENANCE AND CALIBRATION

MAINTENANCE

The meter test button should be occasionally cleaned to remove any buildup of dirt, wax, or finger oils.
The meter foot plate should be occasionally cleaned to remove any buildup of dirt, wax, or other foreign materials.
If the meter is run on battery power, the battery will need to be occasionally replaced after 20,000 or so readings

CALIBRATION TESTING

The combo tester is self-calibrating, but it can be tested by either:

- sending it back to your distributor,
- testing it with Combo Meter Calibration box available from your distributor,
- or by testing with three resistors as shown in the following diagram. For the 100M meter use 1M - 90M 1% resistors. For the 1000M meter use 10M – 800M resistors. The results are displayed in the regular EsdTest program strap test window.

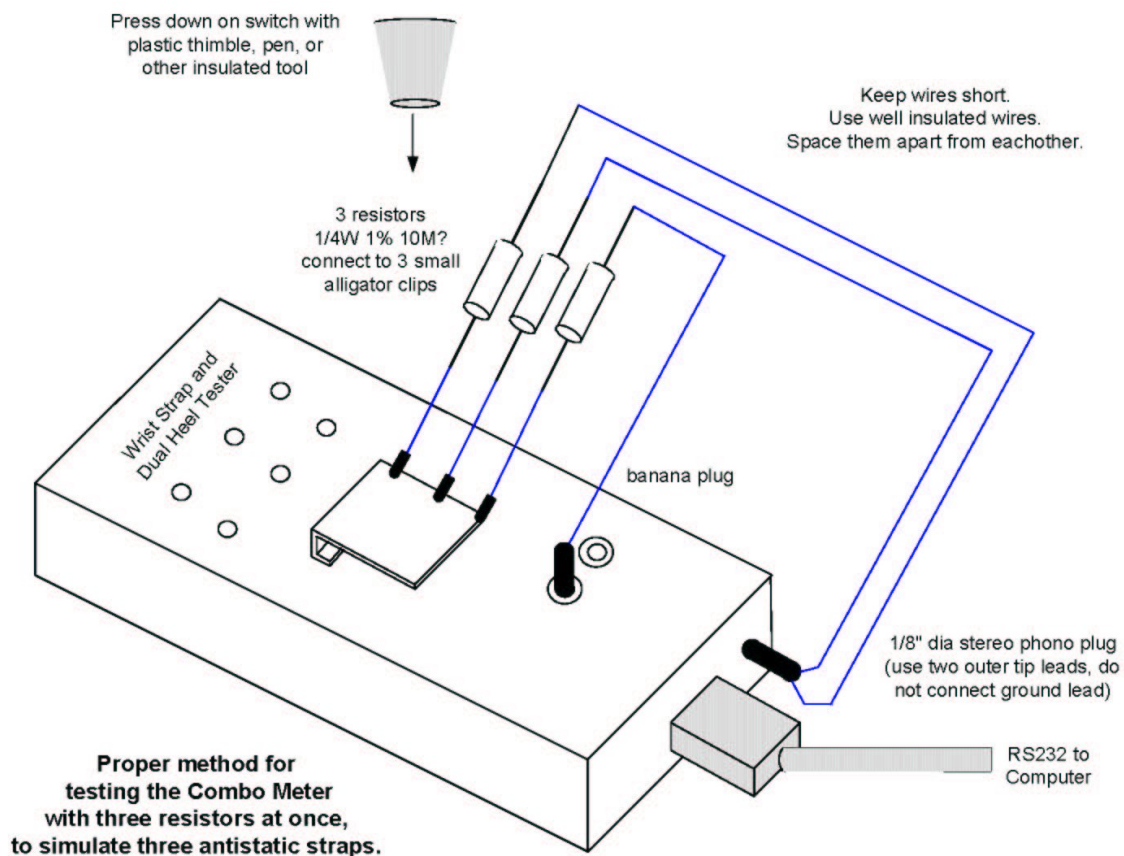

TROUBLESHOOTING AND FREQUENTLY ASKED QUESTIONS

(FAQ)

What are the major problems encountered when setting up a system?

1. Using the wrong communication port.
2. Not checking off the correct report or card identification box in the software.
3. Not setting up the correct electrical limits in the software and matching it to the default settings set up on the DIP switch settings inside the meter.
4. Installing the RS-232 cable so it protrudes from the edge of the stand will cause problems because the plug will bend and become dislodged from the jack.
5. Low battery if not using the AC power supply or rechargeable battery option.
6. Not backing up and resetting the test data file Log.txt after one year. Too much data will slow down the system.
7. Not reading the help files or instructional manual.
8. If in doubt call ACL and we will run through the system while you are on the keyboard.

My barcode/mag stripe scanner does not read

1. Increase or decrease the speed of the swipe in both directions
2. Turn the card around, offering the readable side
3. Check that the code offered is within the design parameters (Code 39)
4. Check cable connections, remove and re-insert.
5. Check to see if the reader is reading the exact amount of characters on a persons' identification card. If not delete or add the correct numbers.

I want my system to read a card that is not in the system. Does the card have to be installed manually?

No. Check off "Unknown ID configuration. This will ask if the card should be added. Check yes and type in the name shown on the card.

If a failed tested is repeated and passes at another test station, but the report says the person failed, what is wrong?

The test station times are not synchronized. All test stations *must* be set with the same time. See Synch.bat

How do I hook up the two pig tail wires which are on the "special" meter with the door opening option?

The relay circuit is normally open. When the test results are passed, the two leads will close because of the activation of the low voltage relay in the meter and allow the passage of a maximum of 24 volts at 500milliamps through the relay to the door. See the connection diagram listed above.

How do I change the regional settings?

Make sure the regional settings are mm/dd/yyyy and not mm/dd/yy. To change click start, settings, control panel, regions, dates, short date setting= mm/dd/yyyy.

When the reports are printed slow what should be done?

The log.txt file should be reset periodically to prevent it from growing so huge that it slows down the report processing. Click on "setup" and then select the "Reset Log File" item. It will ask for a backup file (for example Log0699.txt for June 1999) For small companies this should be done at least once a year on January 1st. Every January 1st, the LogHist.txt on the test station computers should also be deleted. You may also want to check with Windows Explorer to see if there are any other huge files with recent dates.

What can be done if a password is forgotten?

Open the EsdTest.ini file with a word processor program. You will see the password on one of the lines marked Password.

How big a system is needed on the computer?

Suppose you have 2500 people in a company and they test three times a day for 280 days. Each data entry has approximately 80 characters. Therefore you need 168 megabytes or fewer than 2 Gigs hard drive capacity. If the file is reset each month a smaller hard drive will be required.

What can be done if the readings for the foot wear are low?

Check the footplate wire. Insert the wire completely into the meter. Workers wearing leather shoes that are wet will produce low readings.

How far can the computer/monitor be located away from the ACL-750?

Probably 50 feet with a normal RS-232 cable and up to 200 feet with special low capacitance cable and up to a mile with a RS-485 converter. However, the computer monitor should be visible to the employee to tell if there is a problem, inform the user regarding certification dates, or desire to print out reports. If using a USB to serial converter for the card reader, make sure that the converter is located close to the computer, since USB cables can only be a few meters long.

I am using an RS232 to USB converter, but do not see any information from the meter when the test button is pressed.

It sounds like your RS232/USB converter is not functioning.

1. Make sure no other program is trying to access the com port
2. Check the MS Device manager and make sure it says the port is functioning. (Start, Settings, Control panel, System, Hardware, Device Manager)
3. Try setting it to a different com port.
4. Make sure it is a fully compliant +/-12V serial RS-232 converter. Many of the less expensive converters are only +5/-0 or +/-5 and will not work.
5. If you have a serial port on the computer, use that instead of the USB converter
6. Try a different computer
7. Check with the USB converter manufacturer's technical support group.
8. Order the correct RS232/USB converter from your EsdTest distributor

The customer has all their employee details on an Excel spreadsheet. Can you download this information directly from Excel, instead of inputting each record separately?

Yes. All the information is in the enclosed manual. Use one row for each employee, and make sure the columns follow our format, then save the file in a .csv format which will create a text file with the fields separated by commas, then rename the files as names .txt.

To set up the first time, just do the opposite with our present names.txt file. Copy the names.txt file to names .csv and open it with Excel. This will show you what it looks like in Excel. You do need at least the three first columns (names and ID number) to make a names.txt file, the EsdTest program will use default values for the rest of the columns if you do not supply them. See the section above on "Exporting names from Excel".

Currently if a user tests, fails, tests again and passes, the report will only show the pass. Is there any way to record the full history of test results?

All test results are stored in the log.txt file. You can see it in the Entire log report, the Daily log report, or in the individual log report.

I would like to know if we can make the reports more user friendly like the Windows format not like the DOS format?

The monthly report is abbreviated so that all 31 days fit across one page. The other reports also fit across a page. Every report generates two files: a .txt and a .csv file, so that you can import the report into your favorite word processor or spreadsheet program and then reformat it any way you please.

Can you modify the system while it is performing tasks?

Typically the administrator will update the server names.txt file and then download it to the individual test stations. The individual test station will read the new names.txt file just before someone tests. So the answer is yes.

Regarding the "leave status" buttons, can they be modified to show criteria that is specific to the user company?

Yes. See the help file.

What is the maximum number of records that can be stored on the system?

It depends on the hard drive of the server or computer being used. A 10 Gig system should keep 30000 employees' three tests per day for a year. After a year save all the data on a CD.

Is there any information available besides what is on the HELP file?

All operating information is contained in this manual and the individual topic help files in the main EsdTest directory.

What can I do if my HID or Casi-Rusco card does not work?

See the card reader trouble shooting sections above.

Can we use a USB cord?

Yes. You can purchase a RS-232 to USB converter for the card reader for under \$35.00. 15 feet is the maximum length for a USB cable without an extender.

Can we test constant monitor wrist straps to see if they actually drain a charge from your body?

Yes you can. Merely insert the 3.5 mm plug into the 3.5 mm jack and press the test button.

Once I set the time for the automatic email it does not execute. I have an email program running always in the background. Why is it not working?

Make sure you have a MAPI compliant program such as Microsoft Outlook Express or Microsoft Outlook.

Try just entering a couple of lines in the Autogenerate Email editor window. Make sure the right hand LastExecuted field is empty.

;Days	Time	Report	WorkGroup	Email Address	Last Executed
MoTuWeThFrSaSu	00:01	Exception	CIA	<u>joe@xyzmail.com</u>	

Press the Start button in the Autogenerate Email window.

The system should generate an exception report for the CIA workgroup, and generate an email to joe@xyzmail.com. If you look in your Microsoft Outlook Express Out or Sent folder, you should see it there. The system should then add the time it did this to the last field as shown below:

MoTuWeThFrSaSu	00:01	Exception	CIA	<u>joe@xyzmail.com</u>	3/8/2002 08:47
----------------	-------	-----------	-----	------------------------	----------------

See the section in the above manual on "Auto Generate Email Reports".

If using Outlook instead of Outlook Express, use the Outlook 2000 version without the email security update, since newer versions have so much security built in to them that they will not accept 3rd party program email sending requests.

I forgot to setup an email account before I scheduled Logsort in the AutoGenerate Email window, and it will not let disable it.

To disable the email generator just open the EsdTest.ini file with Notepad or any text processor and change the 47th line
from: 1, Auto start the email server(0=no 1=yes)
to: 0, Auto start the email server(0=no 1=yes)
Save the file and restart the EsdTest program.

To use Outlook Express instead of Outlook as the MAPI client,
either right click on your Internet Explorer icon and click properties, or open Internet Explorer and click Tools, Internet options
click the "Programs" tab
select "Outlook Express" in the E-mail box.
click OK

To use Outlook, either use Outlook 2000 without the security updates, or use a later version of Outlook and have your IT administrator set up a public Outlook security folder to disable the warnings (see the Microsoft Knowledge Base Article # 263297 at <http://support.microsoft.com/kb/263297/en-us>).

I tried the generating of the Exception Report, both manually and through email. But, still it does not have the most recent update. Am I doing something wrong?

By "most recent update" do you mean that it generates a report but not with the most recent test data?
If this is the case, run the Reports, View Entire Log. Make sure the most recent test date is there. If not, and if you are running from a server (i.e. you are not running from the local test station), you either need to run the Logsort.exe program (manually or automatically), or have all test stations running from the same log.txt file by settings their working directories to the same folder. We recommend the logsrt.exe method. Please read the manual on how to set up the netlist.txt file with the proper test station paths. Also make sure that the dates in the Log.txt data are in chronological order. A sudden jump forward to the future can cause the report generator to stop searching.

Does the Exception Report get updated automatically after each test?

No. The exception report does not get updated after each test, it needs to be run either:

1. Manually from the Reports, Exception menu or

2. Automatically from the AutoGenerate mail window.

I get an error saying: Runtime error '339' - Component 'msmapi32.ocx' or one of its dependencies not currently registered: a file is missing or invalid.?

This file is included on our installation disk and should have been automatically installed by our installation CD. So here are your options:

- a. Try uninstalling and reinstalling the software using the latest version.
- b. If that does not work, try installing the file manually:
 - Copy the file from the CD at D:\System32\Redist\MS\System\msmapi32.ocx to your system directory C:\Windows\System32
 - Register it by clicking Start, Run, and type: regsvr32 c:\Windows\System32\msmapi32.ocx

When the operator scans his/her badge, a DOS window pops up, and I have to close it myself manually. What can I do?

The DOS window is caused by the Synch.bat program (Refer to the manual). If you are running multiple test stations you need to synchronize the ties to the server. If you have another way of doing this then just rename the synch.bat file to something else like Synch.bak and disregard the rest of the instructions listed below:

1. Using Windows Explorer, right click on the Synch.bat file, select Edit (this will open the Synch.bat file in Notepad for editing) and make sure the server computer name is correctly saved and exit.
2. Using Windows Explorer, double left click on the Synch.bat file to run it. Make sure it runs correctly with no error message. Close the DOS window.
3. Using Windows Explorer, right click on the Synch.bat file, select properties and click the box that says "Close on Exit".

Can I use other data base programs for generating my Names.txt file?

Our database input file names.txt is extremely simple - it is just a text file with the fields separated by commas, with a record (line of text) for each employee. In almost every data base program ever designed (including Excel and MS Access), it can be generated by exporting the data as a .csv file. If you can export your employee data base with just three fields per employee - last name, first name, and badge#, our program will fill in the remaining fields with default values.

You can open the attached names.txt file with a word processor, or rename it to names.csv and open it with Excel.

If you want to specify more fields, they are:

Field 1 – Last name, Field 2 – First name, Field 3 – Group-ID:Badge, Field 4 – Wrist min, Field 5 – Wrist max, Field 6 – Foot min, Field 7 – Foot max, Field 8 – Wrist enabled (-1 = yes, 0 no), Field 9 – Foot enabled, Field 10 – Leave status, Field 11 – Start date, Field 12 – Stop date, Field 13 – Certification type, Field 14 – Certification expiration, Field 15 – string of 365 attendance characters.

Please see the sections above on importing and exporting names.txt to Excel and Access, and the feature to allow access to company remote data bases to read employee names directly.

Some test stations will not recognize a card, or a card is read differently at differently test stations

A quick reader test if you are using USB readers, is to take a card that is giving you trouble and:

1. Go out to a test station where the card is known to work properly
2. Open up Microsoft Word (note RS232 readers will require using Hyperterminal instead of Word)
3. Click Tools, Options, View, Formatting marks, All
4. Click on the main window text area
5. Scan the card - it should display all the characters on the card. Try several times if intermittency is suspected.
6. Write down all the characters that were displayed.
7. Repeat the above at the other test station that does not work properly
8. The two should be identical. If not, then either the card is bad, the reader is bad, or the two readers are not programmed the same.

If the card reads the same at each station with Microsoft Word, then also check whether our software is set to interpret the reader the same way at each station:

1. Go out to a test station
2. Open our EsdTest program
3. Click Setup, Employee Selection
4. Note the settings
5. Click Edit Reader Parameters (if visible) and also note the settings
6. Repeat the above at the other test station
7. The two should be identical if the readers are identical.

If the problem still can not be located, make sure that:

1. The Names.txt file is the same at both stations (or that both are reading the same common Names.txt file)
2. The EsdTest software version is the same at each station (click Help About)

The new software does not allow me to select my old HID 5352 card reader that my older software used

The new software still indirectly supports old readers. Just copy your old EsdTest.ini file to the C:\EsdTest directory (or where ever the EsdTest.exe working directory is located.)

When emailing reports I get a pop up box saying "A third party program is trying to send email in your name"

Microsoft recently added major security updates to Outlook 2002 which prevents other programs (such as EsdTest) from using it to send MAPI email messages without popping up a warning message "A program is automatically trying to send email on your behalf." The solutions are:

- if your company is using Microsoft Outlook 2002 with Microsoft the Exchange Server, then have the administrator set up a public Outlook security folder to disable the warnings (see the Microsoft Knowledge Base Article # 263297)
- switch to Outlook Express (which is not fully compliant with Microsoft Exchange) or another MAPI compliant email program
- or switch to Outlook 2000 without the email security update,
- or download ClickYes Pro from <http://www.contextmagic.com/express-clickyes/> and modify the Outlook security settings
- or download the free Express ClickYes program from <http://www.contextmagic.com/express-clickyes/> (Set it to always be suspended)
- or install the ClickYesSetup.exe file included on the installation CD. This will automatically dismiss the message. (set it to always be suspended)

What other security measures can I apply.

- Use the EsdTest Administrator password
- Put the EsdTest icon in the Startup menu to boot upon startup
- Boot-up in Windows "Guest" mode.
- Activate the EsdTest Administrator password.
- Get rid of all other program icons.
- Removing the shortcut keys from the registry (see Microsoft website).
- Lock up the keyboard

When I try to run the ver 9 or later EsdTest program I get a message saying that file FM20.dll is not registered or Error 7 - Out of Memory, or Module not found, or System error &&H8007007E.

This file normally comes with Microsoft Outlook. If you do not have Microsoft Outlook installed then:

1. Make sure you run the complete ver 9 installation file
2. if you still have trouble, click Start, Run and type:
RegSvr32 c:\windows\system32\fm20.dll (or what ever the correct file path is)
3. If you still have trouble then go to
<http://msdn.microsoft.com/library/default.asp?url=/library/en-us/dnaxctrl/html/cpad.asp>
click on Setuppad.exe. Or look and see if MsSetupPad.exe is included on our installation disk, and click on it.
4. If your c:\windows\fm20.dll file is older than 1/11/1999, then go to
<http://office.microsoft.com/downloads/9798/fm2paste.aspx>
and install the update.

When I try to run the ver 9 or later EsdTest program I get a message saying that file scrrun.dll is not registered or Module not found.

1. try click Start, Run and type:

RegSvr32 c:\windows\system32\scrrun.dll

2. If there is still a problem, make sure you have the correct script files installed. Go to:

<http://msdn.microsoft.com/library/default.asp?url=/downloads/list/webdev.asp>

(Microsoft Windows Script Downloads)

and download the correct scripting files for your system.

When I try to display in Chinese, I only see square boxes and question marks.

You do not have the Chinese font loaded. Download and install the "Office XP Tool: Simplified Chinese Language Pack"

<http://www.microsoft.com/downloads/info.aspx?na=47&p=3&SrcDisplayLang=en&SrcCategoryId=&SrcFamilyId=959EB2A2-FAC3-4443-999B-8BE12734A596&u=details.aspx%3ffamilyid%3dDEB6731A-CA36-47A3-B4A0-2A1D19EEFA05%26displaylang%3den>

What are the power adapter requirements?

The combo meter is shipped with a power adapter that has been tested by ACL to be compatible with the meter. Using other supplies may invalidate the warranty. If another supply is used, it must conform to the following specifications:

1. 9-15VDC, filtered, > 50ma
2. The output connector must be a 2.5mm ID, 5.5mm OD, 12mm long barrel, female power connector, with the center pin connected to positive voltage (i.e. center positive).
3. If a switching power supply is used, make sure the output noise is low, and an RFI filter choke is included on the cable (such as a Steward 28A0592-0A2 or 28A0350-0B2).
4. In high noise environments, use 4 EMI filter chokes (such as a Steward 28A0592-0A2 at each end of the power cable and one on the foot plate cable near where it connects to the meter, and a Steward 28A0593-0A2 on the RS232 cable near the combo meter connector.)

Thus typical power supply adapters can be:

- 9VDC unregulated (i.e. 9-15VDC)
- 9VDC regulated
- 12VDC unregulated (i.e. 9-15VDC)
- 12VDC regulated

(Note - many 9VDC supplies come with a 2mm ID connector which will not work. Neither will a 9.5mm long connector)

If an Ethernet adapter is used, it's 12VDC supply can usually be used to power the meter.

When I boot the program I get a message saying "Printer problem - Make sure a printer is selected and has the proper driver.

Check that:

- the printer has a name assigned to it (i.e. the name can be blank) (Start, Settings, Printers, Default (i.e. the printer with the little check by it)
- the printer font size in the Setup, General window is not 0
- the printer font name in the Setup, General window is not blank
- If the computer is not connected to a printer then add a generic printer driver:

Start, Settings, Printers, Add A Printer, Next

More troubleshooting tips are available through ACL' customer service Meter Department. Special systems can be ordered from ACL, which will open doors, print labels, or have an upper limit of 1000 megohms.

WARANTEE AND LICENSE AGREEMENTS

LIMITED WARANTEE:

ACL warrants for a period of one year from the date of purchase the ACL-750 will be free of defect in material. Within the warranty period the meters will be replaced free of charge. Any meters returned shall be shipped prepaid to ACL along with a return authorization number and proof of purchase.

Exclusions.

The above warranty will not apply to defects or damage due to accidents, misuse, design alterations, neglect, operator error, failure to clean or maintain the meters.

Limitations:

In no event shall ACL be responsible for any loss, damage, injury, direct or consequential, arising out of the use of or the inability to use the meters. Before using, users shall determine the suitability of the product for their intended use. Users will assume all risk and liability what so ever in connection therewith.

SOFTWARE LICENSE AGREEMENT:

ACL is willing to license the enclosed software only upon the condition that all of the terms of the software license agreement are accepted. Please carefully read all of the terms of this agreement during the installation process prior to clicking the "I accept the terms of this license". By continuing to install the software you accept the terms and conditions of this agreement.