

PLUG P/N	CKT	DIM "A"	DIM "B"
1727621002	2	5.40	4.95
1727621004	4	9.60	4.95
1727621006	6	13.80	4.95
1727621008	8	18.00	4.95
1727621010	10	22.20	12.95
1727621012	12	26.40	12.95
1727621014	14	30.60	12.95
1727621016	16	34.80	12.95
1727621018	18	39.00	20.95

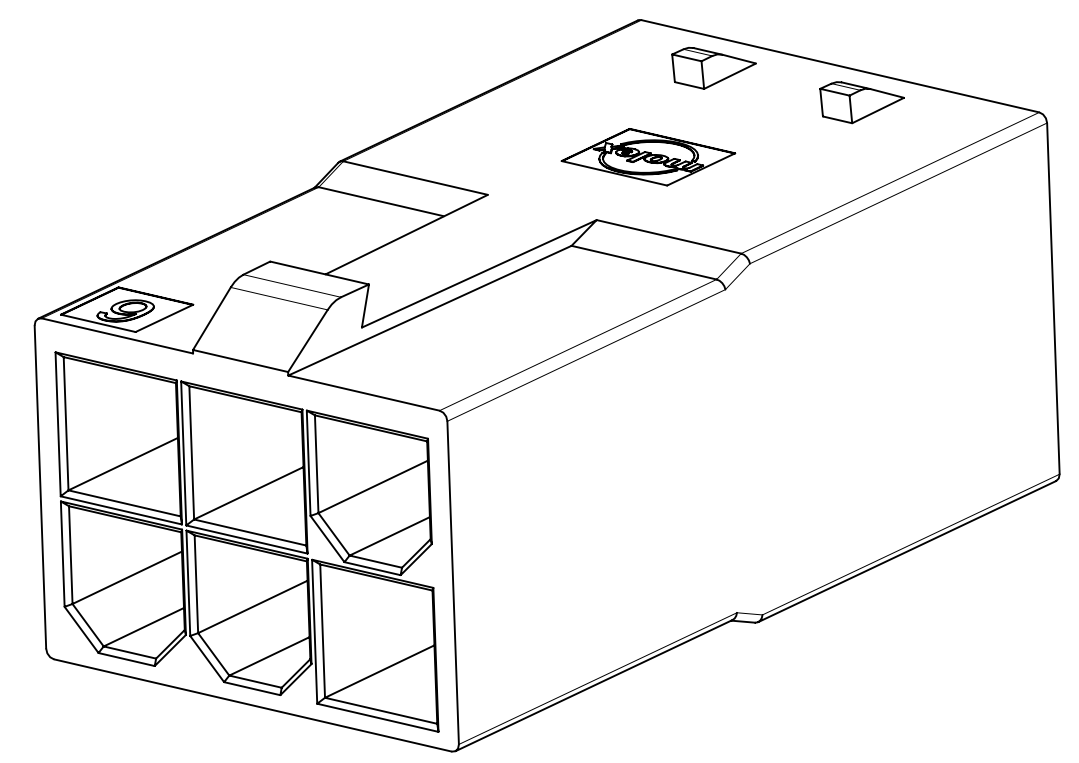
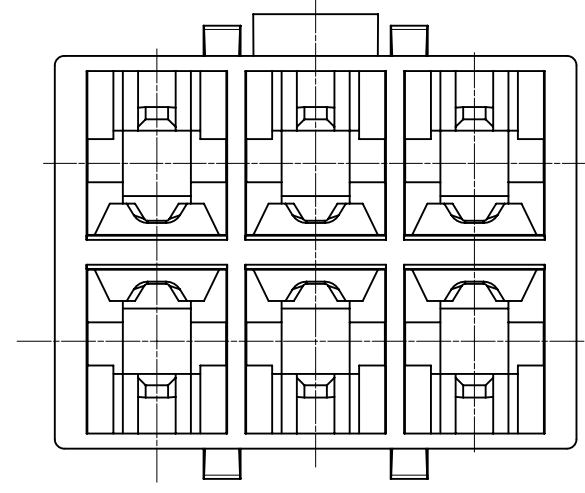
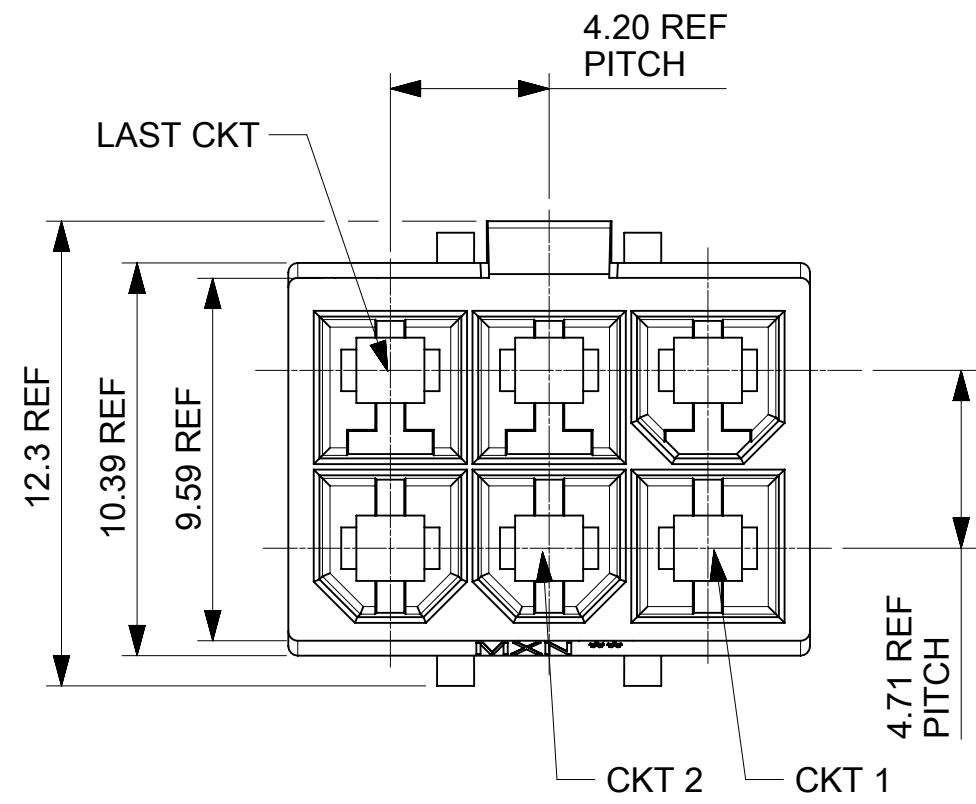

- NOTES:
1. MATERIAL: NYLON, UL 94V-0 AND GLOW WIRE CAPABLE PER IEC60335-1; COLOR: BLACK
  2. FINISH: NONE
  3. PRODUCT SPECIFICATION: 2131370000-PS/2029880002-PS
  4. APPLICATION SPECIFICATION: 2131370000-AS
  5. PACKAGING SPECIFICATION: 172762-0001-PK
  6. REFER TO AS-45499-001 FOR MOISTURIZING NYLON CONNECTOR PARTS.
  7. THIS PART TO BE USED WITH FEMALE TERMINAL SERIES 172765, 203070 AND TPA SERIES 172709-2\*\*\*.
  8. THIS PART MATES WITH RECEPTACLE SERIES 172708-1\*\*\*
  9. THIS PART CONFORMS TO CLASS 'B' REQUIREMENTS OF COSMETIC SPECIFICATION PS-45499-002.
  10. SEE DRAWING 1727090002-SD FOR OTHER TPA INFORMATION.
  11. SEE DRAWING 1727080002-SD FOR RECEPTACLE INFORMATION.
  12. SEE DRAWINGS SD-172718-0000 AND 2029880001-PSD FOR OTHER CRIMP TERMINAL INFORMATION.

THIS DRAWING CONTAINS INFORMATION THAT IS PROPRIETARY TO MOLEX ELECTRONIC TECHNOLOGIES, LLC AND SHOULD NOT BE USED WITHOUT WRITTEN PERMISSION

DIMENSION UNITS	SCALE	CURRENT REV DESC:		<b>molex</b>			
mm	NTS						
GENERAL TOLERANCES (UNLESS SPECIFIED)				SD-DRAWING OF MINI-FIT SIGMA DR PLUG			
ANGULAR TOL	±	°		PRODUCT CUSTOMER DRAWING			
4 PLACES	±			DOCUMENT NUMBER			
3 PLACES	±			1727620001-SD			
2 PLACES	±	0.25		DOC TYPE		DOC PART	
1 PLACE	±	0.36		PSD		000	
0 PLACES	±			REVISION		A5	
DRAFT WHERE APPLICABLE MUST REMAIN WITHIN DIMENSIONS		THIRD ANGLE PROJECTION		DRAWING		SERIES	
		A2-SIZE		172762		MATERIAL NUMBER	
				SEE TABLE		CUSTOMER	
				GENERAL MARKET		SHEET NUMBER	
						1 OF 4	

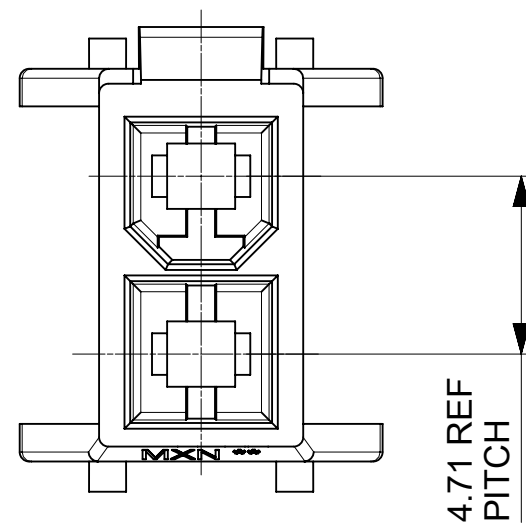
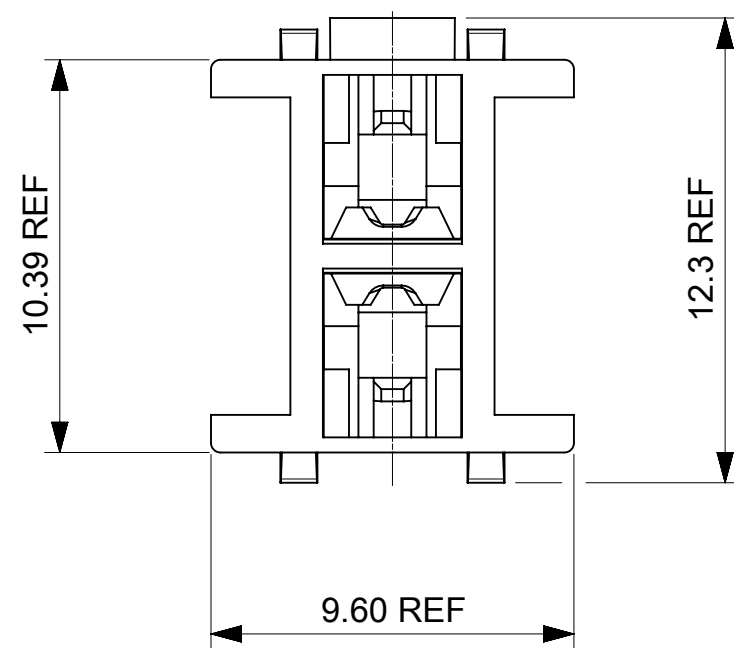
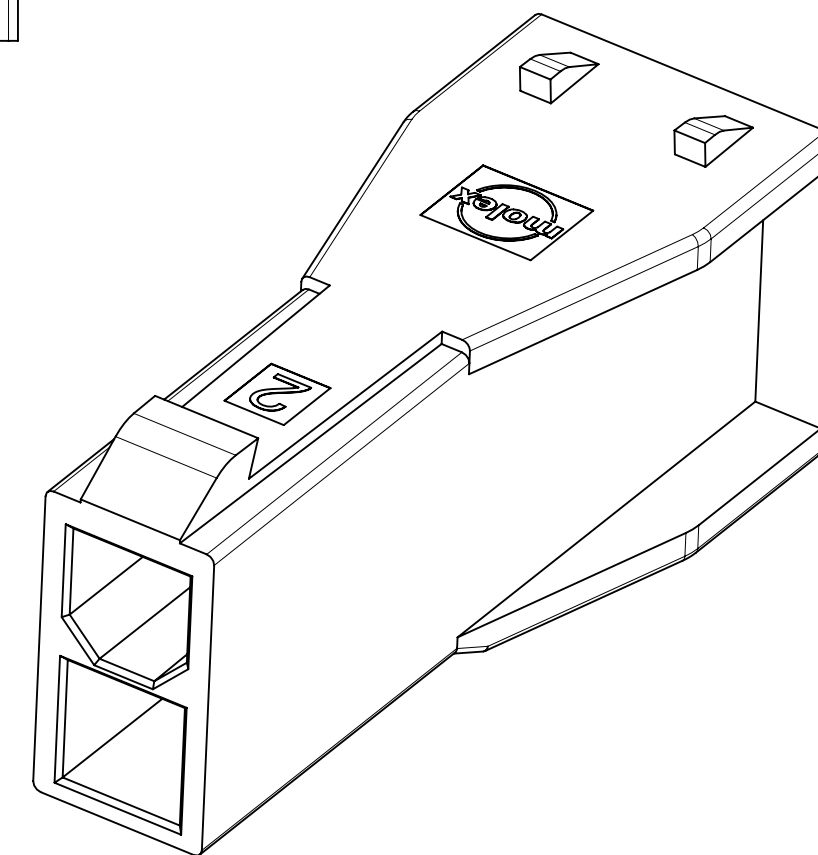
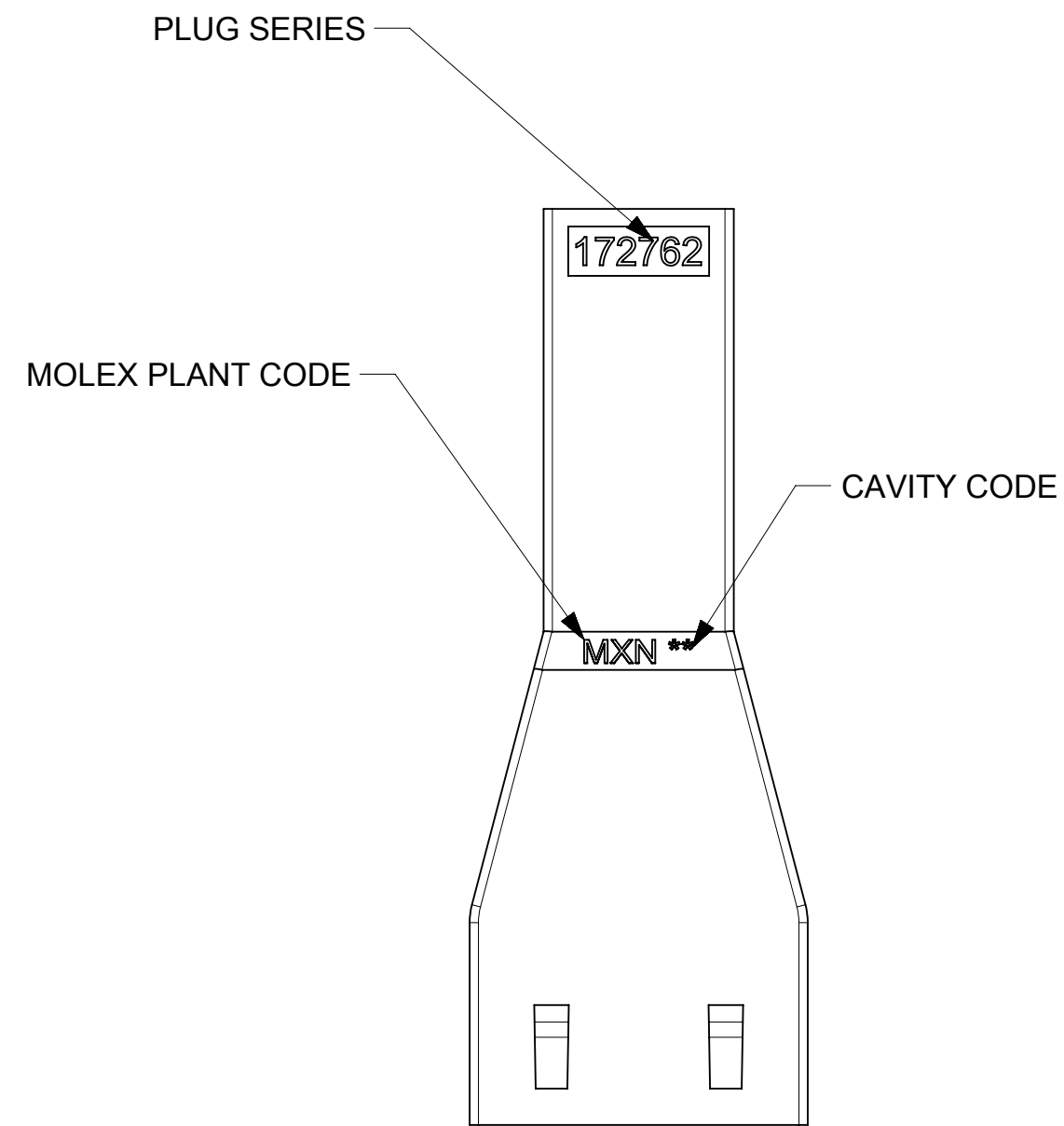
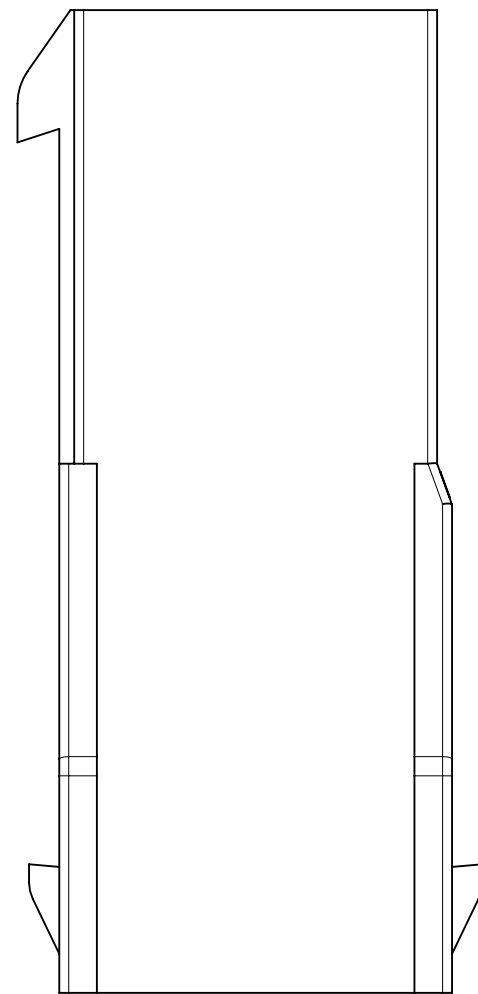
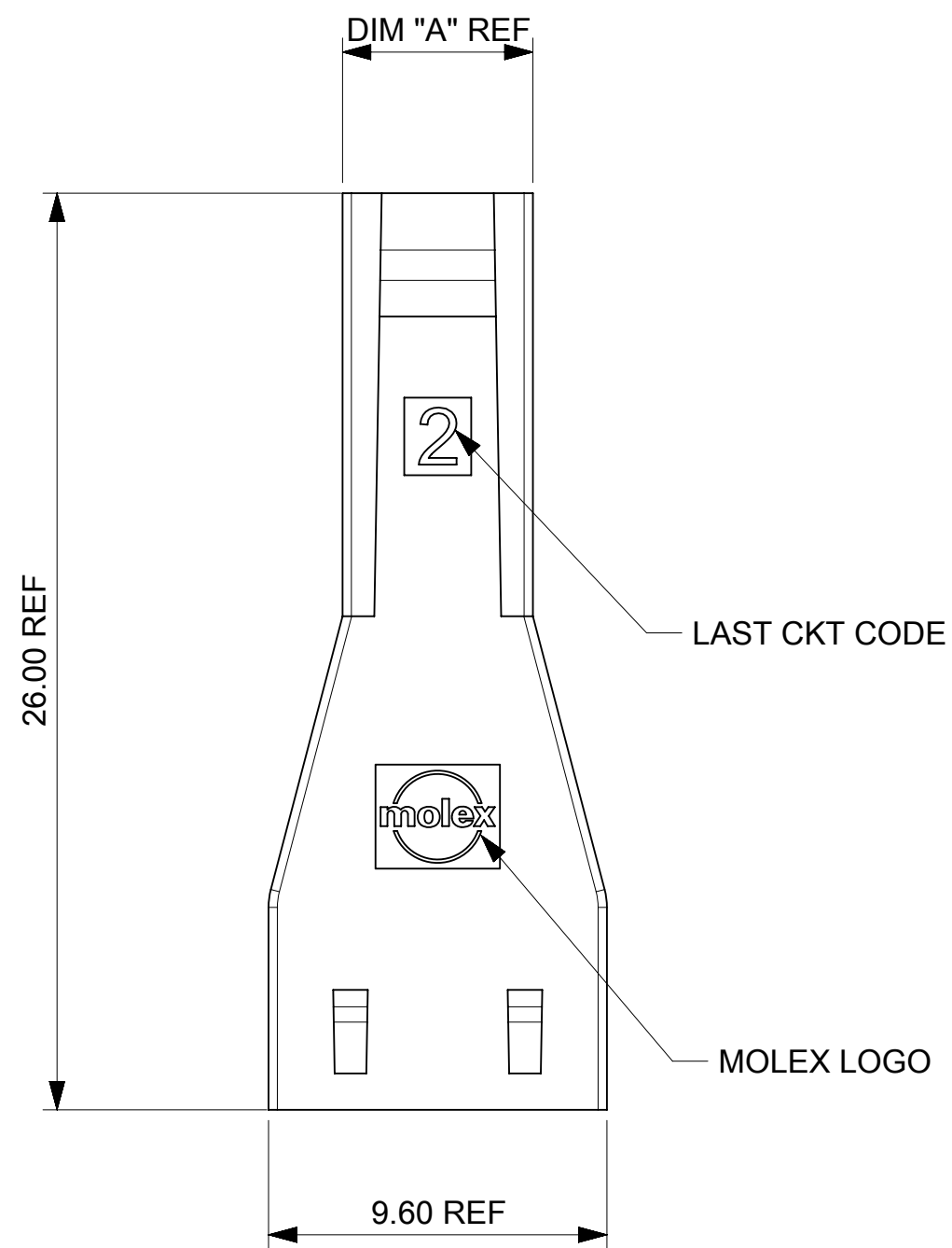

THIS DRAWING CONTAINS INFORMATION THAT IS PROPRIETARY TO MOLEX ELECTRONIC TECHNOLOGIES, LLC AND SHOULD NOT BE USED WITHOUT WRITTEN PERMISSION										
DIMENSION UNITS	SCALE	CURRENT REV DESC:				<b>molex</b>				
mm	NTS									
GENERAL TOLERANCES (UNLESS SPECIFIED)						SD-DRAWING OF MINI-FIT SIGMA DR PLUG				
ANGULAR TOL	± °					PRODUCT CUSTOMER DRAWING				
4 PLACES	±	EC NO: 735375								
3 PLACES	±	DRWN: JERRYW8	2023/01/06							
2 PLACES	± 0.25	CHK'D: XQZHANG	2023/02/01							
1 PLACE	± 0.36	APPR: XQZHANG	2023/02/01							
0 PLACES	±	INITIAL REVISION:				DOCUMENT NUMBER		DOC TYPE	DOC PART	REVISION
DRAFT WHERE APPLICABLE MUST REMAIN WITHIN DIMENSIONS		DRWN: ALU002	2019/09/18		1727620001-SD		PSD	000	A5	
		APPR: YXZHENG	2019/10/11		SEE TABLE		GENERAL MARKET		SHEET NUMBER	
		THIRD ANGLE PROJECTION	DRAWING	SERIES	MATERIAL NUMBER	CUSTOMER	2 OF 4			
			A2-SIZE	172762						

DOCUMENT STATUS	P1	RELEASE DATE	2023/02/01	07:45:18
-----------------	----	--------------	------------	----------

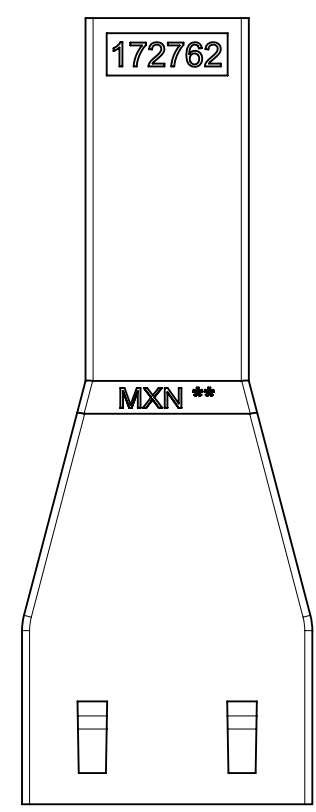
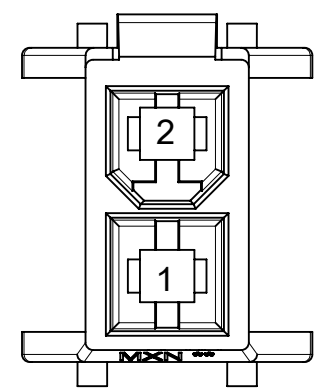

2-CKT

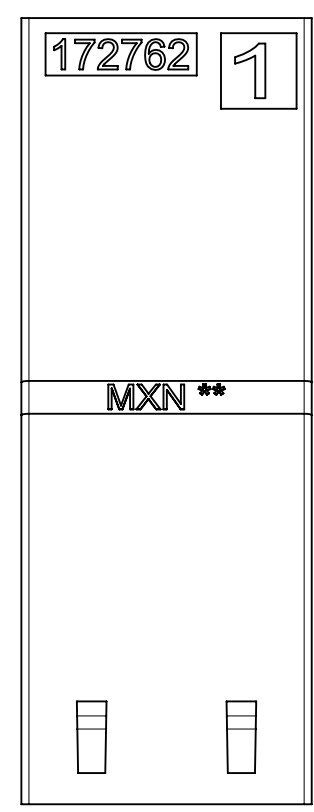
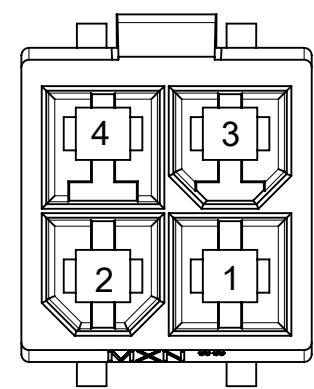

4-CKT

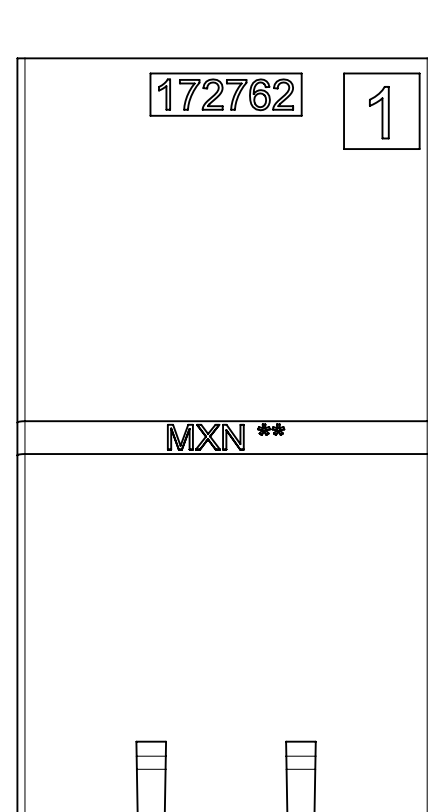
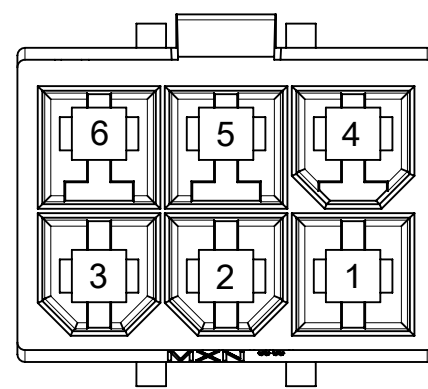

6-CKT

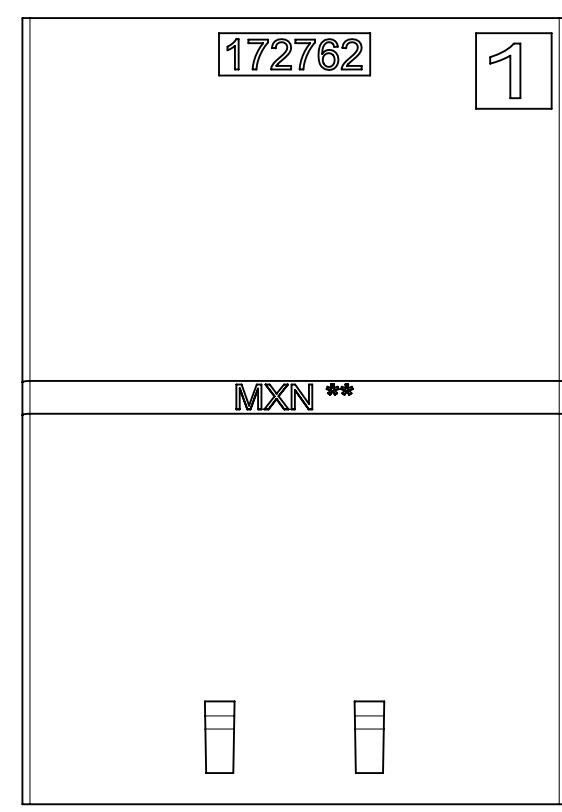
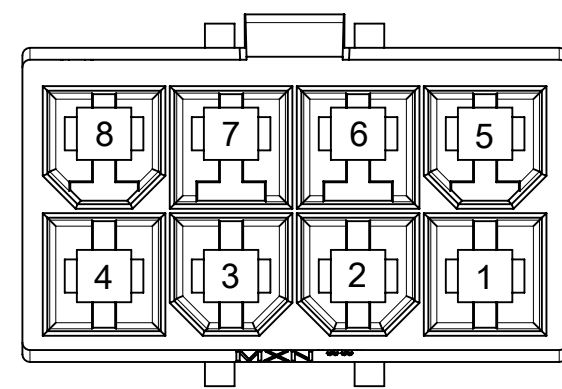

8-CKT

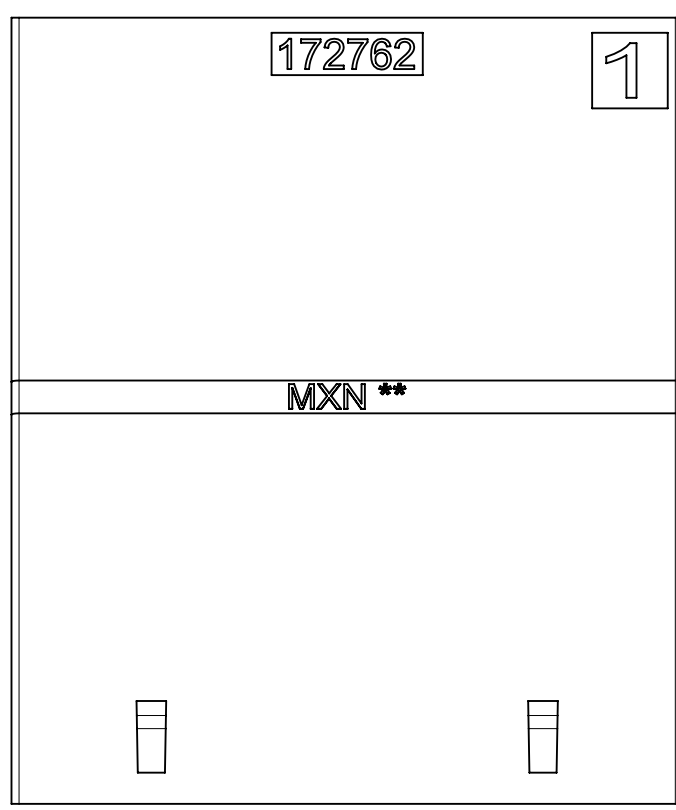
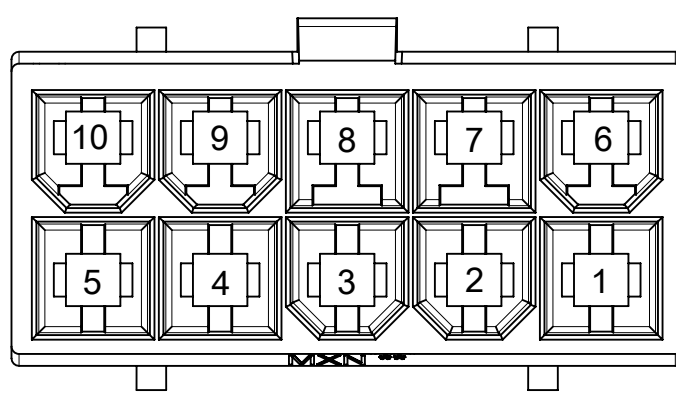

10-CKT

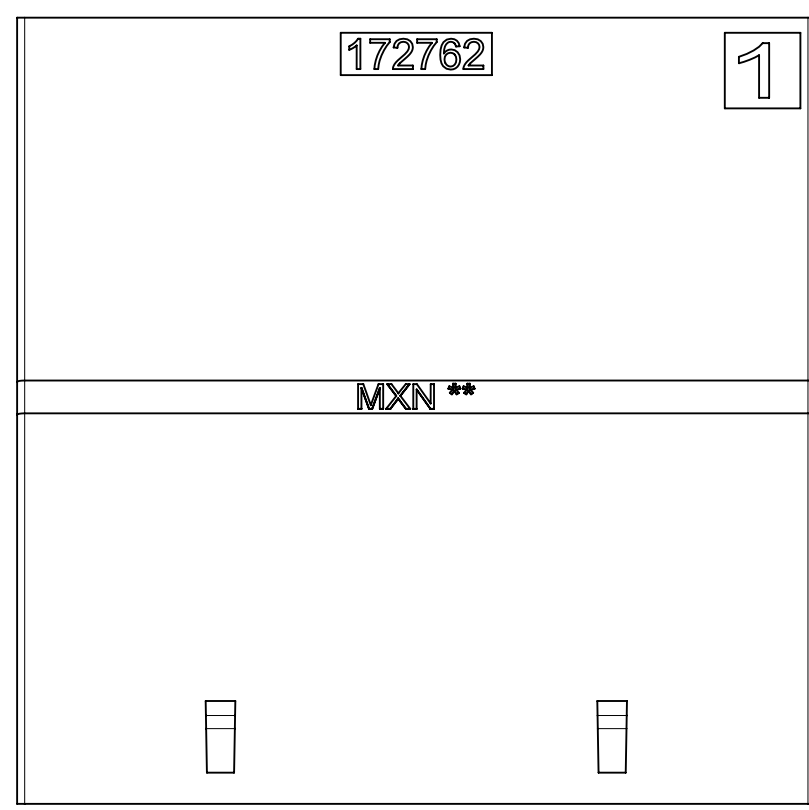
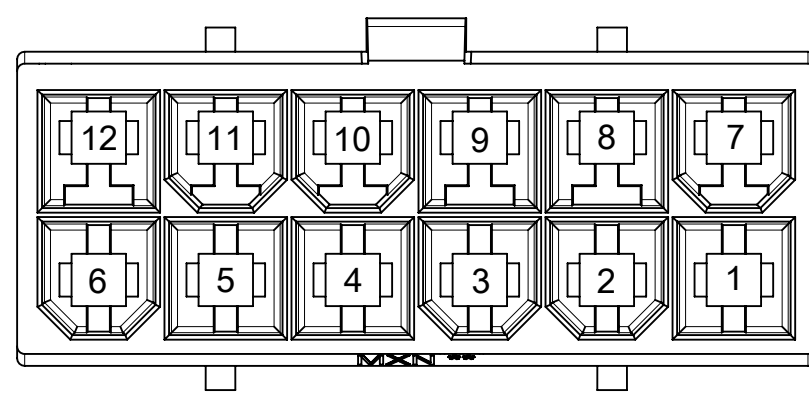

12-CKT

THIS DRAWING CONTAINS INFORMATION THAT IS PROPRIETARY TO MOLEX ELECTRONIC TECHNOLOGIES, LLC AND SHOULD NOT BE USED WITHOUT WRITTEN PERMISSION										
DIMENSION UNITS	SCALE	CURRENT REV DESC:								
mm	NTS									
GENERAL TOLERANCES (UNLESS SPECIFIED)					SD-DRAWING OF MINI-FIT SIGMA DR PLUG					
ANGULAR TOL	± °	EC NO: 735375			PRODUCT CUSTOMER DRAWING					
4 PLACES	±	DRWN: JERRYW8			2023/01/06					
3 PLACES	±	CHK'D: XQZHANG			2023/02/01					
2 PLACES	± 0.25	APPR: XQZHANG			2023/02/01					
1 PLACE	± 0.36	INITIAL REVISION:			DOCUMENT NUMBER					
0 PLACES	±	DRWN: ALUO02			1727620001-SD					
DRAFT WHERE APPLICABLE MUST REMAIN WITHIN DIMENSIONS		THIRD ANGLE PROJECTION		DRAWING	SERIES	MATERIAL NUMBER	CUSTOMER	DOC TYPE	DOC PART	REVISION
				A2-SIZE	172762	SEE TABLE	GENERAL MARKET	PSD	000	A5
										SHEET NUMBER
										3 OF 4

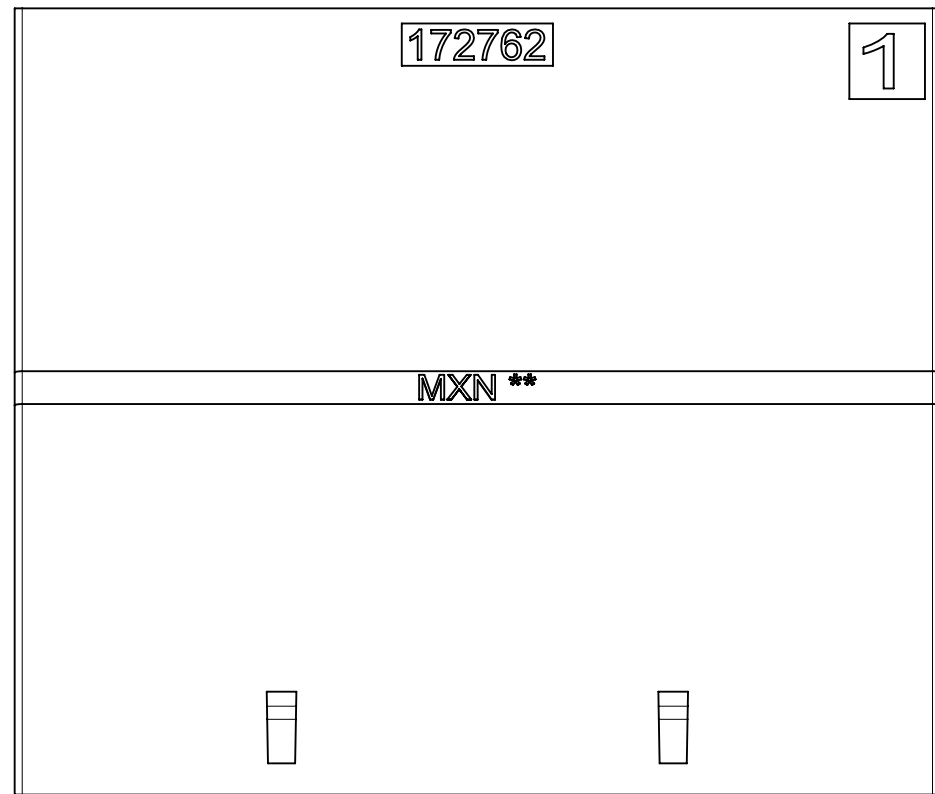
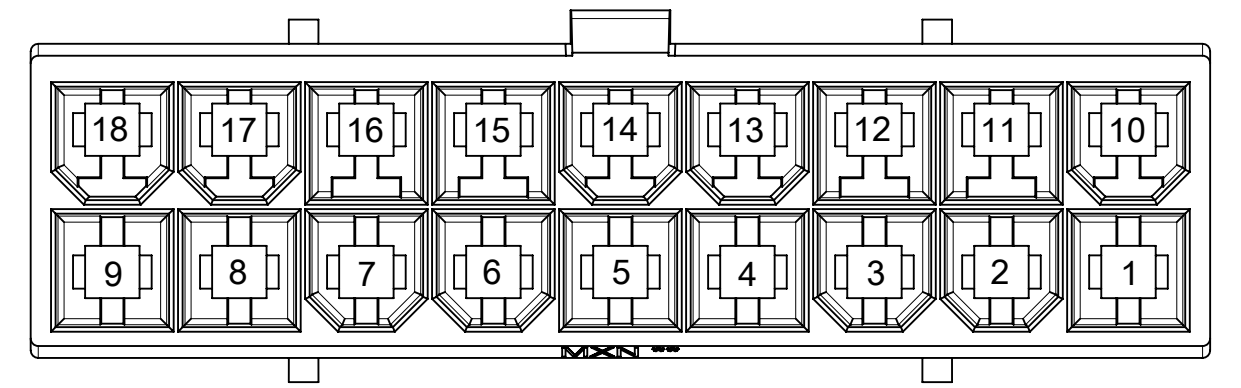
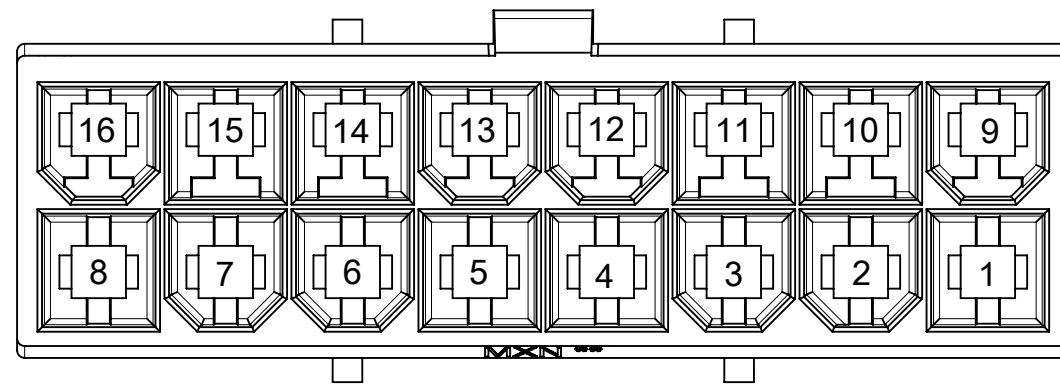
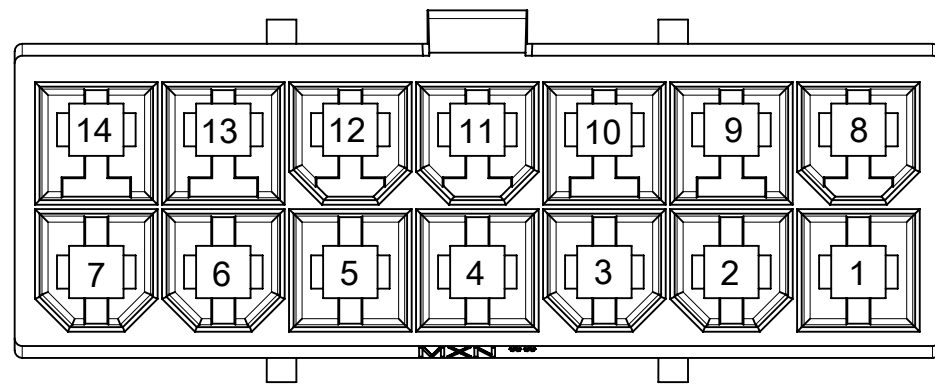

14-CKT

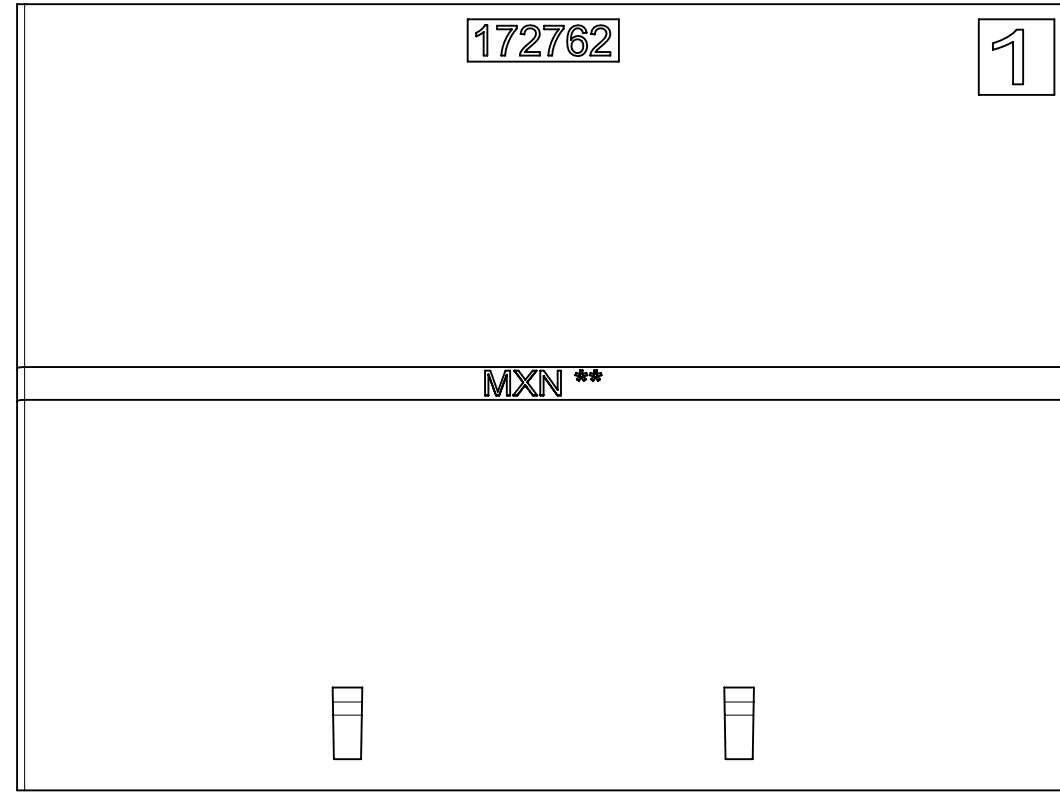

16-CKT

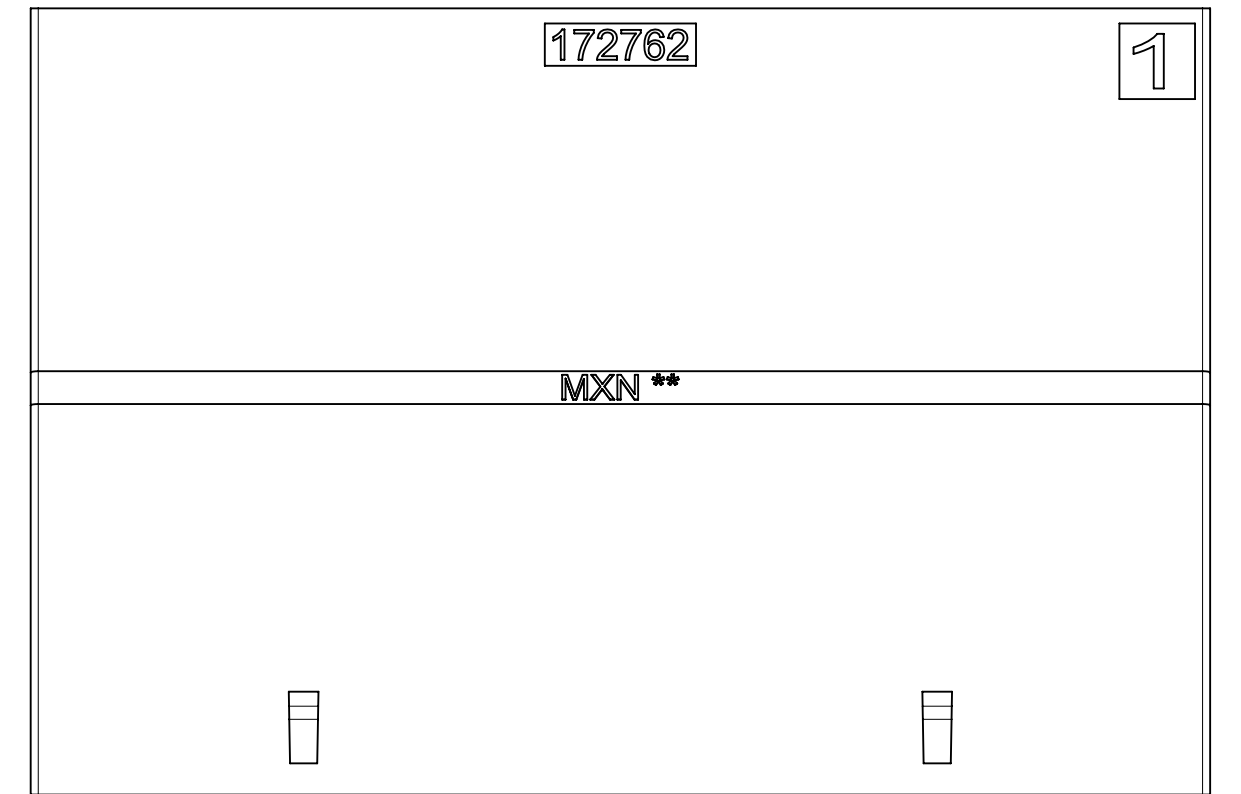

18-CKT

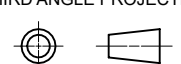
THIS DRAWING CONTAINS INFORMATION THAT IS PROPRIETARY TO MOLEX ELECTRONIC TECHNOLOGIES, LLC AND SHOULD NOT BE USED WITHOUT WRITTEN PERMISSION									
DIMENSION UNITS	SCALE	CURRENT REV DESC:							
mm	NTS								
GENERAL TOLERANCES (UNLESS SPECIFIED)					SD-DRAWING OF MINI-FIT SIGMA DR PLUG				
ANGULAR TOL	±	°							
4 PLACES	±	EC NO: 735375			PRODUCT CUSTOMER DRAWING				
3 PLACES	±	DRWN: JERRYW8 2023/01/06							
2 PLACES	±	CHK'D: XQZHANG 2023/02/01			DOCUMENT NUMBER				
1 PLACE	±	APPR: XQZHANG 2023/02/01							
0 PLACES	±	INITIAL REVISION:			1727620001-SD				
DRAFT WHERE APPLICABLE MUST REMAIN WITHIN DIMENSIONS									
THIRD ANGLE PROJECTION		DRAWING		SERIES		MATERIAL NUMBER		CUSTOMER	
		A2-SIZE		172762		SEE TABLE		GENERAL MARKET	
								SHEET NUMBER	
								4 OF 4	