

## SSR21NH-M07890

Aliases (UALM21H0789000)

KEMET, SSR21NV-M/NH-M, AC Line Filters, Common Mode, 89 mH

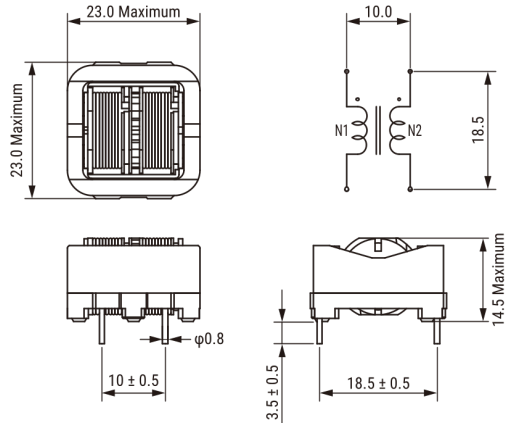

Click [here](#) for the 3D model.

### Dimensions

L	23mm MAX
T	23mm MAX
H	14.5mm MAX
LL	3.5mm +/-0.5mm
S	10mm +/-0.5mm
S1	18.5mm +/-0.5mm
Wire Size	0.28mm

### Packaging Specifications

Packaging	Tray
Packaging Quantity	420
Component Weight	13 g

### General Information

Series	SSR21NV-M/NH-M
Style	Through-Hole
Features	High Performance, High Impedance, Strong Inductance
RoHS	Yes
Miscellaneous	65 (K) Temperature Rise Max.
Core	Mn-Zn Ferrite

### Specifications

Voltage AC	250 VAC
Inductance	89 mH (10 kHz)
Current	700 mA
Temperature Range	-25/+120°C
DC Resistance	1.05 Ohms