

S-LINK

Related Information ■ General terms and conditions..... F-7

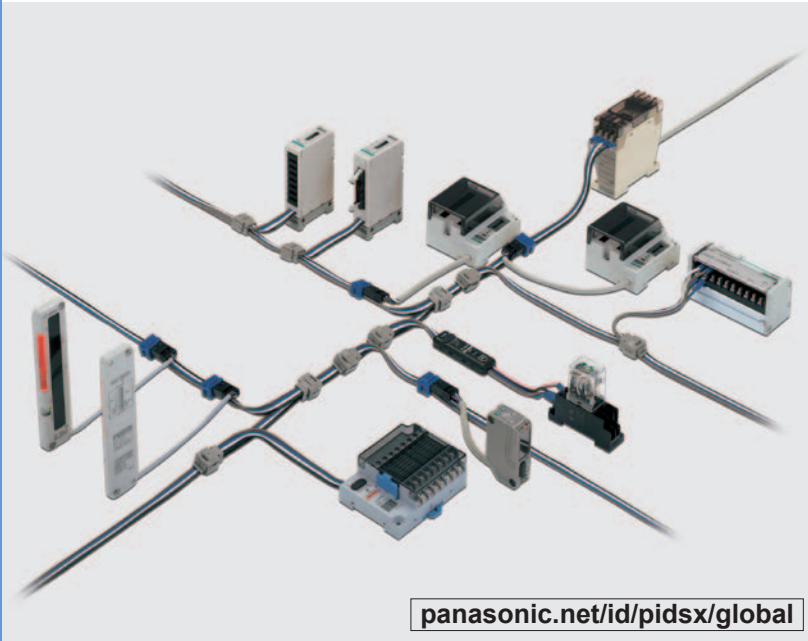

panasonic.net/id/pidsx/global

This product is introduced to only limited countries. Please contact our office for details.

S-LINK transmits 128 points on two signal lines, and "T"-branch multi-drop system enabling flexible cable layout

We've realized a wire-saving system that's easy to use

Remote I/O

Just with the wire-saving between the PLC and the sub-stations, you'll be able to save a mountain of I/O device connection wires.



The remote I/O is one-dimensional wiring

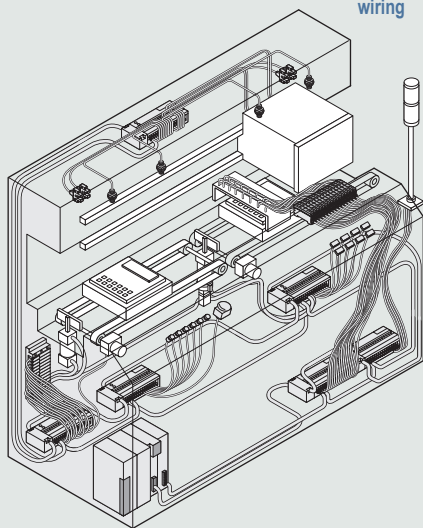

S-LINK

Allows for great wire-saving for all connections. Installation is made easy with no faulty wiring. The power supply line can also be wired up together enabling true wire-saving for I/O devices.



The S-LINK is two-dimensional wiring

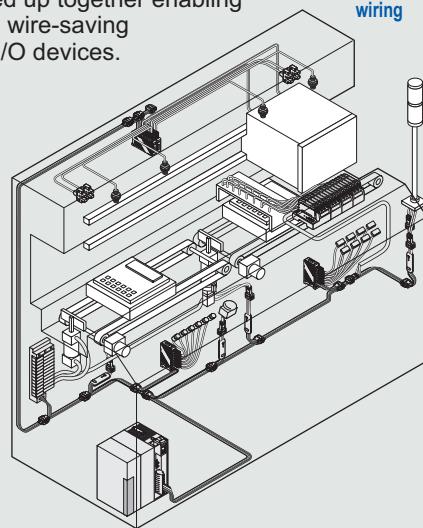

Transmission distance:
 200 m **656.168 ft** (400 m **1312.336 ft** when using booster)
 Total wiring length:
 400 m **1312.336 ft** (800 m **2624.672 ft** when using one booster)
 Connectable I/O: 128 points
 (The maximum number of sub-stations which can be connected: 128 nodes)

FIBER SENSORS

LASER SENSORS

PHOTOELECTRIC SENSORS

MICRO PHOTOELECTRIC SENSORS

AREA SENSORS

LIGHT CURTAINS / SAFETY COMPONENTS

PRESSURE / FLOW SENSORS

INDUCTIVE PROXIMITY SENSORS

PARTICULAR USE SENSORS

SENSOR OPTIONS

SIMPLE WIRE-SAVING UNITS

WIRE-SAVING SYSTEMS

MEASUREMENT SENSORS

STATIC ELECTRICITY PREVENTION DEVICES

LASER MARKERS

PLC

HUMAN MACHINE INTERFACES

ENERGY CONSUMPTION VISUALIZATION COMPONENTS

FA COMPONENTS

MACHINE VISION SYSTEMS

UV CURING SYSTEMS

For Large Scale Systems
 For Medium Scale Systems

S-LINK

High noise immunity

Large voltage amplitude (24 V) and wide pulse width (35 μ s) signal transmissions make for units less prone to impulse noise effects with no code errors. This high level of noise proofing enables them to be used even in worksites with conventional, high-priced optical communication remote I/O units.

Specifies malfunctioning S-LINK I/O devices

In the event that verification cannot be obtained from an **S-LINK** I/O unit, such as if the main cable is cutoff, the address of the particular unverifiable **S-LINK** I/O unit is specified and displayed allowing equipment recovery time to be greatly reduced.

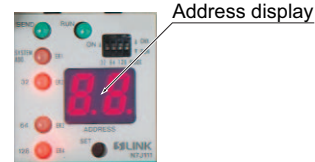

Alleviates the burden laid on engineer for designing and wiring

Labor-saving hook-up connectors are used enabling multiple "T"-branch hookups. It goes without saying that cascade wiring (bus wiring) as well as multiple branch wiring (star wiring) is also possible.

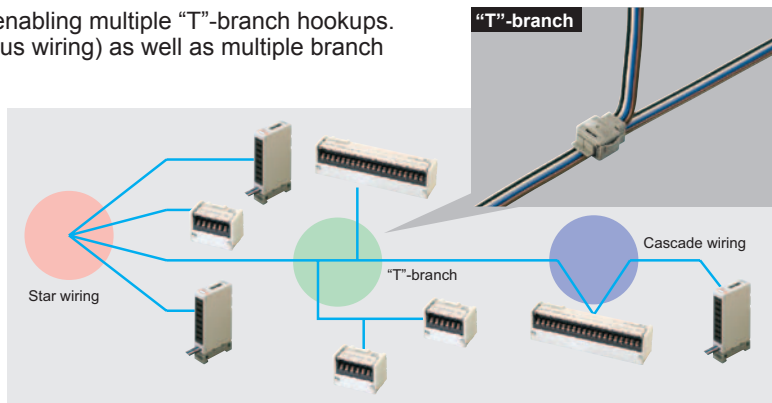

Simple and reliable connections

We've provided all types of hook-up connectors. Connections from **S-LINK** I/O devices to the main cable and from sensors and other devices to **S-LINK** I/O devices are all realized with one-touch hook-up connectors. They can be connected anywhere quickly and maintenance is easy.

Branch cable to main cable connection and S-LINK I/O device to main cable connection

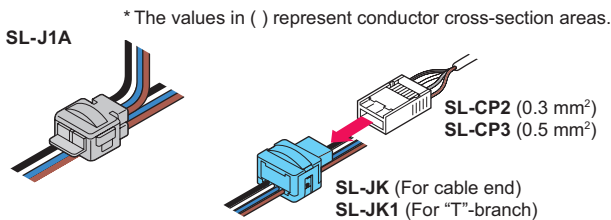

Connection from various connected units to S-LINK I/O devices

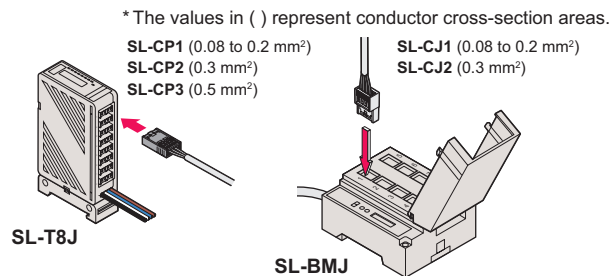

In addition, to enhance the reliability of the crimping, **S-LINK** exclusive pliers are made available so that anyone can do it with ease.

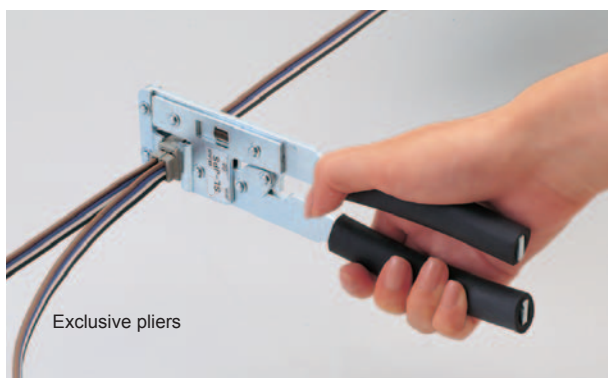

Connected device extensions

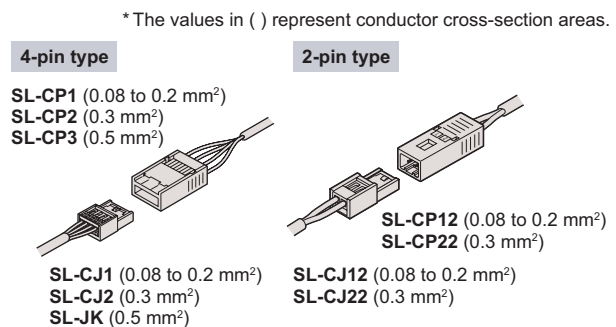

FIBER SENSORS

LASER SENSORS

PHOTOELECTRIC SENSORS

MICRO PHOTOELECTRIC SENSORS

AREA SENSORS

LIGHT CURTAINS / SAFETY COMPONENTS

PRESSURE / FLOW SENSORS

INDUCTIVE PROXIMITY SENSORS

PARTICULAR USE SENSORS

SENSOR OPTIONS

SIMPLE WIRE-SAVING UNITS

WIRE-SAVING SYSTEMS

MEASUREMENT SENSORS

STATIC ELECTRICITY PREVENTION DEVICES

LASER MARKERS

PLC

HUMAN MACHINE INTERFACES

ENERGY CONSUMPTION VISUALIZATION COMPONENTS

FA COMPONENTS

MACHINE VISION SYSTEMS

UV CURING SYSTEMS

For Large Scale Systems

For Medium Scale Systems

S-LINK

- FIBER SENSORS
- LASER SENSORS
- PHOTOELECTRIC SENSORS
- MICRO PHOTOELECTRIC SENSORS
- AREA SENSORS
- LIGHT CURTAINS / SAFETY COMPONENTS
- PRESSURE / FLOW SENSORS
- INDUCTIVE PROXIMITY SENSORS
- PARTICULAR USE SENSORS
- SENSOR OPTIONS
- SIMPLE WIRE-SAVING UNITS
- WIRE-SAVING SYSTEMS**
- MEASUREMENT SENSORS
- STATIC ELECTRICITY PREVENTION DEVICES
- LASER MARKERS
- PLC
- HUMAN MACHINE INTERFACES
- ENERGY CONSUMPTION VISUALIZATION COMPONENTS
- FA COMPONENTS
- MACHINE VISION SYSTEMS
- UV CURING SYSTEMS
- For Large Scale Systems
- For Medium Scale Systems
- S-LINK**

Direct main cable connecting of sensors and actuators possible

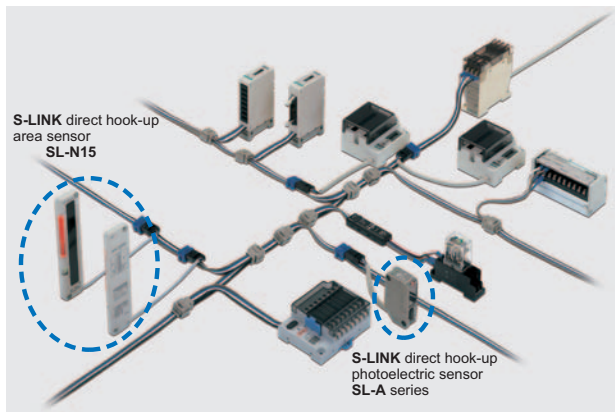

All types of transmission line direct-connecting type sensors are made available. Even partner makers are putting on the market manifold electromagnetic valves and limit switches that can be directly connected with the **S-LINK** system making wire-saving and labor-saving a reality.

Items offered by partner makers

- Manifold electromagnetic valve manufactured by Koganei Corp.
- Manifold electromagnetic valve manufactured by SMC Pneumatics
- Manifold electromagnetic valve manufactured by CKD Corp.
- Component indicator lamp manufactured by Yazaki Industrial Chemical Co., Ltd.

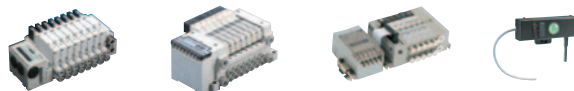

Mid-system main / branch cable installation and removal possible

For conveyors or other large scale equipment, transport can also be done after dividing the whole into units of several meters in length right at the factory. Then, reassembly and wiring can be effectuated onsite afterwards. Because the **S-LINK** can be easily divided even from mid-system main / branch cables with the help of commercially available connectors and terminals, the segmented equipment can be wired up prior to transport. Once onsite, assembly work is all but complete with just the connecting of the individual units to each other.

In addition, when assembling the equipment, the **S-LINK** can work even disconnected from the PLC enabling software (PLC programming) and hardware (machine assembly, I/O check) work to be done concurrently, which results in quick delivery time. With the handy monitor, I/O devices can be checked for each piece of equipment separately enabling subcontractors to conduct check work on delivery. This results in a total delivery deadline reduction and clearly defined subcontractor responsibilities. Also, checking can be performed even without programming so you'll know immediately if malfunctions are coming from the PLC or the **S-LINK**.

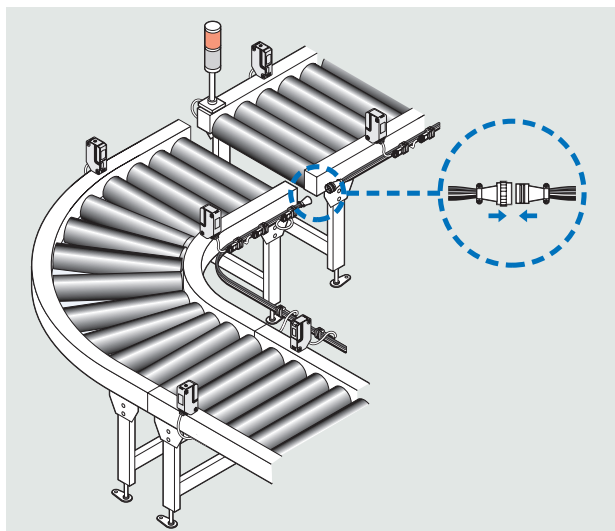

Dividing equipment into subunits possible

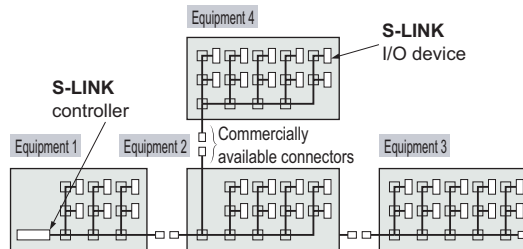

Individual equipment subunits can be checked separately

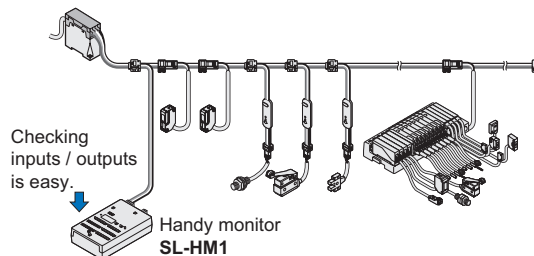

Total cost reductions and great savings in setup time

By introducing the **S-LINK**, you can reduce the total cost of system construction to one-fifth. Total costs including for materials go down dramatically and, by decreasing the workload, construction time is lessened which means you can easily meet that tough deadline.

The **S-LINK** system:

- A hardware-only construction makes layout design simple
- With hook-up connectors, construction time is greatly reduced
- Layout modifications made easy
- Equipment divided into separate segments make for easy debugging
- Segmented equipment can be easily interlinked with commercially available connectors

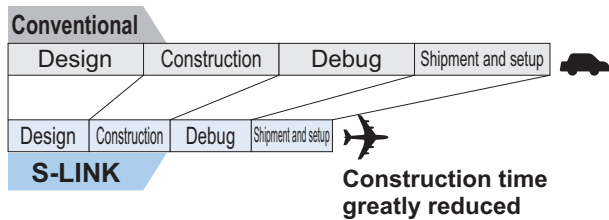

Auxiliary materials reduced

Great reductions in auxiliary materials such as cable racks, cable ducts, intermediate terminal blocks, and cables. This system also contributes greatly to the reduction waste caused by cutting cable ends.

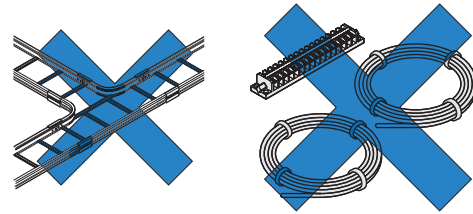

Space-saving

Because of great reductions in the amount of intermediate terminal blocks and cables needed, you can save space and minimize the size of your control board and machines. This will finally let you put all that wasted space to good use.

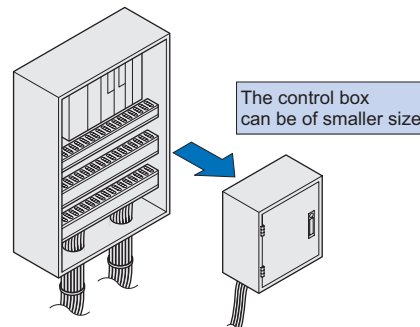

Upper-level network connection possible

Because it can be connected to any main open network, long-distance and multi-point transmission networks can be constructed enabling a greatly enhanced network upgrade. Also, by wiring up scattered bit-oriented I/O devices that include mostly connected sensors and switches, an efficient wire-saving layout can be realized. If exporting equipment that was setup with any open network, it can be made to correspond to different networks just by installing an **S-LINK** gateway controller with the entire **S-LINK** system left as it is.

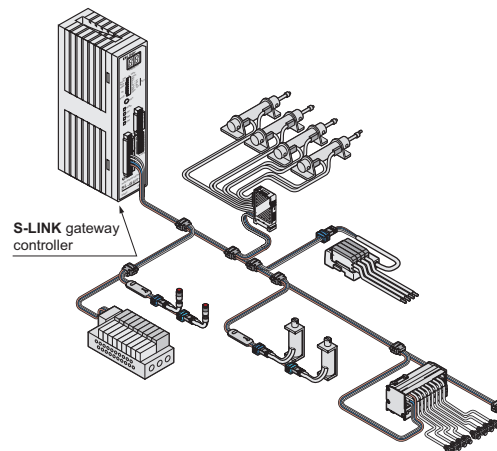

FIBER SENSORS

LASER SENSORS

PHOTOELECTRIC SENSORS

MICRO PHOTOELECTRIC SENSORS

AREA SENSORS

LIGHT CURTAINS / SAFETY COMPONENTS

PRESSURE / FLOW SENSORS

INDUCTIVE PROXIMITY SENSORS

PARTICULAR USE SENSORS

SENSOR OPTIONS

SIMPLE WIRE-SAVING UNITS

WIRE-SAVING SYSTEMS

MEASUREMENT SENSORS

STATIC ELECTRICITY PREVENTION DEVICES

LASER MARKERS

PLC

HUMAN MACHINE INTERFACES

ENERGY CONSUMPTION VISUALIZATION COMPONENTS

FA COMPONENTS

MACHINE VISION SYSTEMS

UV CURING SYSTEMS

For Large Scale Systems

For Medium Scale Systems

S-LINK

APPLICATIONS

Distributed installation

Automatic storage

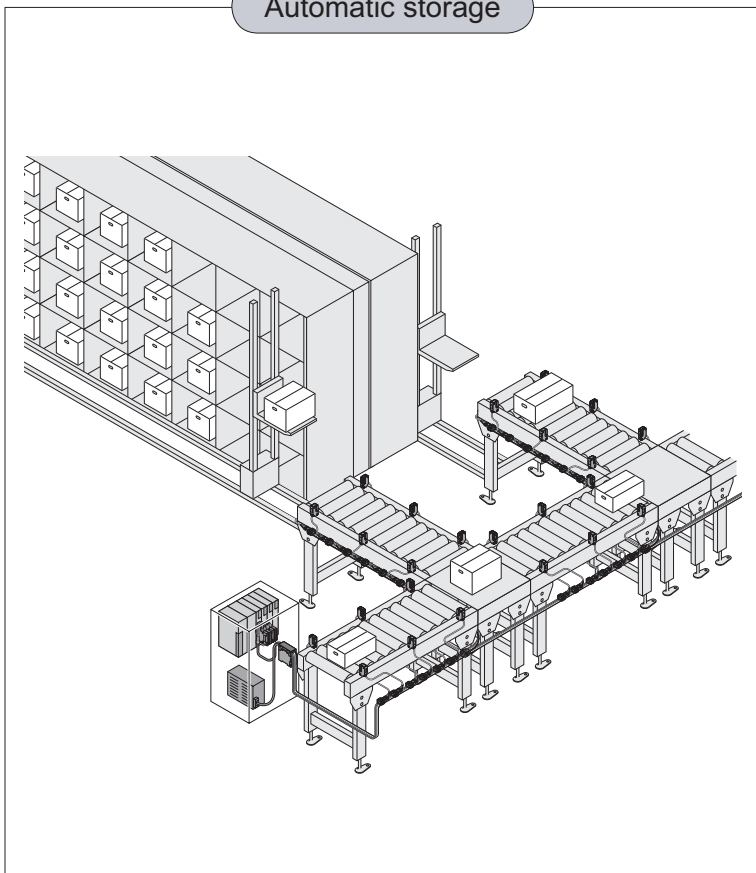

Because conveyors have multiple I/O device points, wire-saving and construction efficiency are the key to lowering overall costs. Other systems may be wire-saving but if they can't prove useful for long-distance distribution lines and be reliable, then they are useless. On this point, the **S-LINK** system offers a total wiring length of 400 m **1312 ft**, 800 m **2625 ft** when using booster, with reliable T-branch I/O device connections that can be mounted in any desired location.

Because T-branching renders layout designing simple, not only is it a wire-saving and construction efficient system, but you can even save time in the actual design stage. In addition, you can divide main and branch cables in mid-system with commercially available connectors and terminals so the time it takes to setup your conveyor decreases greatly.

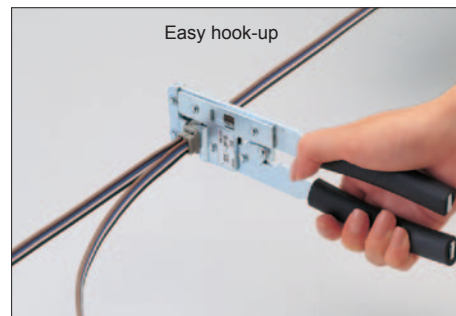

Parking garage

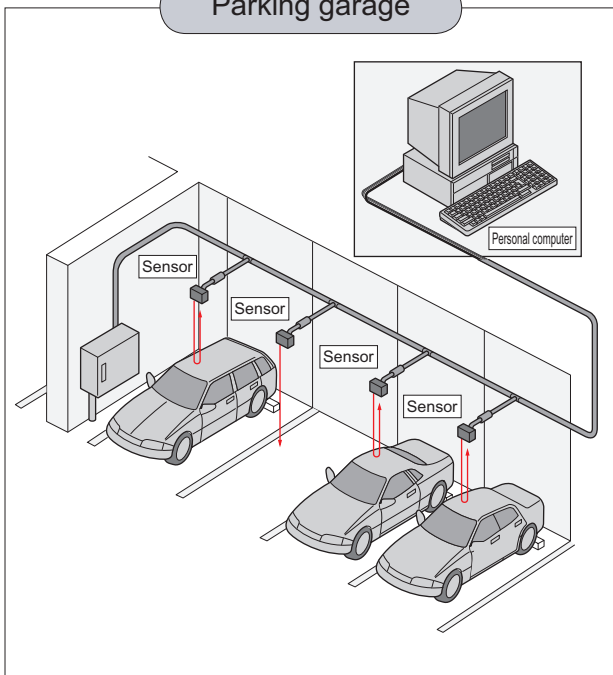

The **S-LINK** system is very suitable to wire up car detection sensors in a large parking garage. It reduces wires and installation time.

Display panel control

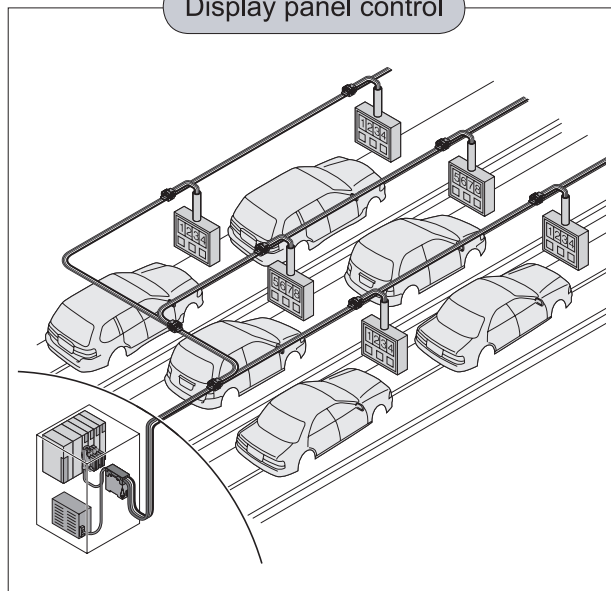

Display equipment can be mounted in automobile production lines to notify operators when malfunctions occur or just to keep a reliable count of units in each line.

Because each type of display equipment shows variegated data, they necessitate a great amount of wiring. This wiring must be conducted in very large factories requiring a substantial amount of cables and wires. A wire-saving system in this situation would be most effective.

Using the **S-LINK** system means that even display equipment can be wired up with just one flat cable, and clearing up all the bulky wiring inside the display panels themselves and realizing great material cost savings as well as a reduced workload.

- FIBER SENSORS
- LASER SENSORS
- PHOTOELECTRIC SENSORS
- MICRO PHOTOELECTRIC SENSORS
- AREA SENSORS
- LIGHT CURTAINS / SAFETY COMPONENTS
- PRESSURE / FLOW SENSORS
- INDUCTIVE PROXIMITY SENSORS
- PARTICULAR USE SENSORS
- SENSOR OPTIONS
- SIMPLE WIRE-SAVING UNITS
- WIRE-SAVING SYSTEMS**
- MEASUREMENT SENSORS
- STATIC ELECTRICITY PREVENTION DEVICES
- LASER MARKERS
- PLC
- HUMAN MACHINE INTERFACES
- ENERGY CONSUMPTION VISUALIZATION COMPONENTS
- FA COMPONENTS
- MACHINE VISION SYSTEMS
- UV CURING SYSTEMS

For Large Scale Systems
For Medium Scale Systems

S-LINK

APPLICATIONS**Integrated installation**

Automatic assembly machine

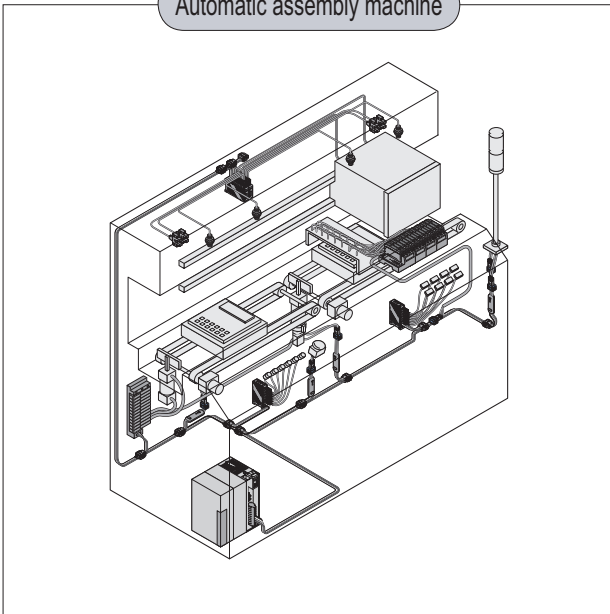

The wire-saving system is being greatly emphasized even for assembly lines crowded with multiple I/O devices. Also, to enhance productivity, using a wire-saving system is the key to reliability and avoiding the occurrence of troubles. In the **S-LINK** loop wiring, the system maintains signal transmission even when the loop may break at any one place. Also, the controller displays disconnected unit address. Further, when excess current flows or short-circuit occurs in the signal transmission lines, the signal transmission is stopped to protect the system. **S-LINK** is a wire-saving system optimal for the automatic assembly machinery.

Turntable

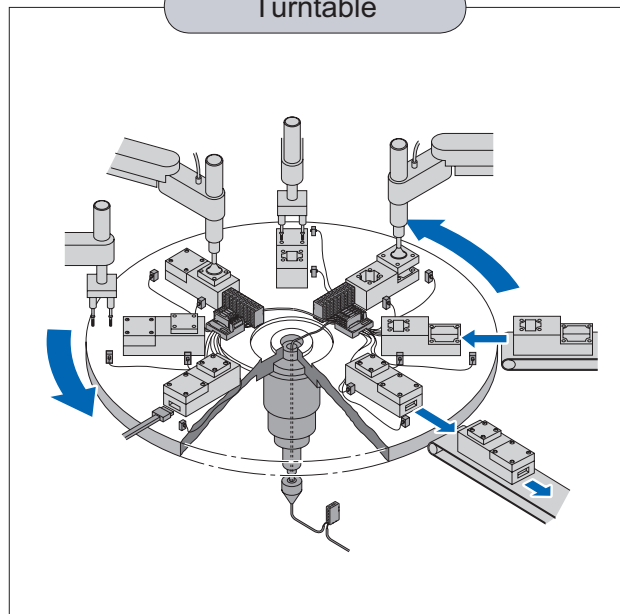

The wiring of I/O devices mounted on a rotating board (turntable) used to be quite a difficult task. Because a slip ring with the same number of terminals as wires had to be used. Therefore, there have been difficulties such as employing a large slip ring or reduction of I/O point count. **S-LINK** enables the connection of up to 128 I/O points on a 4-pole slip ring. A compact slip ring can be used without worrying about I/O points.

Handler

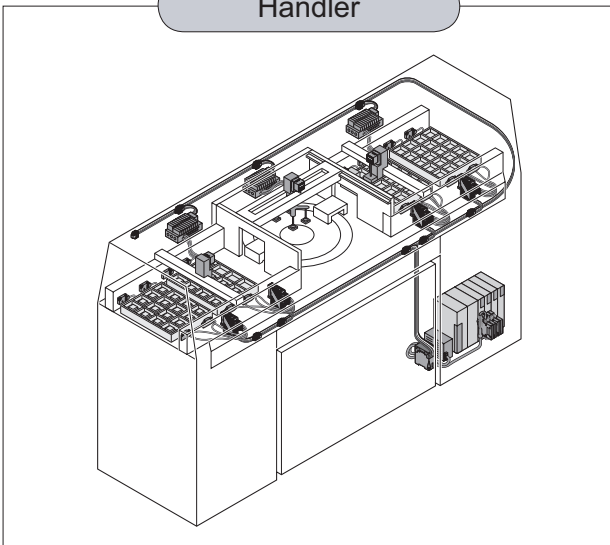

"The handler" as the IC test equipment uses multiple sensors. Cost reduction or downsizing depends on how to reduce these wires and to save space. **S-LINK** realizes wire-saving and space-saving; hence these problems are solved all at once.

Parts picking system

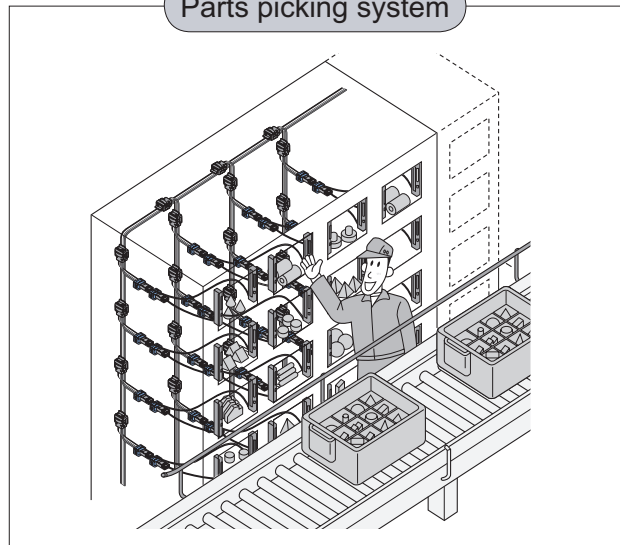

Many small picking sensors are employed in the parts picking system in order to verify the correct selection of components. The number of input points is required as much as the number of shelves, the number of output points is also required to be the same in adopting the operational indicators. **S-LINK** system greatly contributes to wire-saving both in I/O points and in space. Also, extra shelves can be added easily.

FIBER
SENSORSLASER
SENSORSPHOTOELECTRIC
SENSORSMICRO
PHOTOELECTRIC
SENSORSAREA
SENSORSLIGHT CURTAINS /
SAFETY
COMPONENTSPRESSURE /
FLOW
SENSORSINDUCTIVE
PROXIMITY
SENSORSPARTICULAR
USE SENSORSSENSOR
OPTIONSSIMPLE
WIRE-SAVING
UNITS**WIRE-SAVING
SYSTEMS**MEASUREMENT
SENSORSSTATIC ELECTRICITY
PREVENTION
DEVICESLASER
MARKERS

PLC

HUMAN MACHINE
INTERFACESENERGY CONSUMPTION
VISUALIZATION
COMPONENTS

FA COMPONENTS

MACHINE VISION
SYSTEMSUV CURING
SYSTEMSFor Large
Scale Systems
For Medium
Scale Systems**S-LINK**

- FIBER SENSORS
- LASER SENSORS
- PHOTOELECTRIC SENSORS
- MICRO PHOTOELECTRIC SENSORS
- AREA SENSORS
- LIGHT CURTAINS / SAFETY COMPONENTS
- PRESSURE / FLOW SENSORS
- INDUCTIVE PROXIMITY SENSORS
- PARTICULAR USE SENSORS
- SENSOR OPTIONS
- SIMPLE WIRE-SAVING UNITS
- WIRE-SAVING SYSTEMS
- MEASUREMENT SENSORS
- STATIC ELECTRICITY PREVENTION DEVICES
- LASER MARKERS
- PLC
- HUMAN MACHINE INTERFACES
- ENERGY CONSUMPTION VISUALIZATION COMPONENTS
- FA COMPONENTS
- MACHINE VISION SYSTEMS
- UV CURING SYSTEMS

For Large Scale Systems
For Medium Scale Systems

S-LINK

SYSTEM LAYOUT

Upper-level control devices

S-LINK control components

PLC

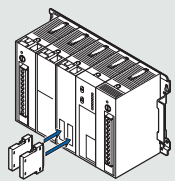

PLC I/O connectors
(for connectable PLC)
SL-S□, SL-P□



CE

Multi-core cable PLC I/O units
(for screw-on terminal type PLC)
SL-S, SL-SP, SL-P, SL-PP



CE

**S-LINK controller
SL-CU1A**



CE

**Booster
SL-BS1A**



CE

**PLC
(Direct connection to PLC bus)**

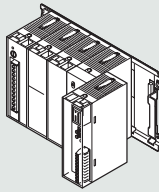

S-LINK controller for direct connection to PLC bus / S-LINK control boards

**FPΣ
S-LINK unit
FPG-SL**



**FP0 S-LINK
Control unit
FP0-SL1**



**FP2SH
S-LINK unit
FP2-SL2**



For Mitsubishi Electric Corp.
PLC MELSEC-Q series
SL-MEL-Q



CE

For Yokogawa Electric Corp.
PLC FA-M3 series
SL-FAM3



CE

Items offered by partner makers

Controllers manufactured by
JTEKT Corp.
THU-5291



Personal computers

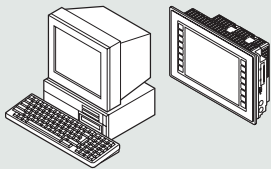

For ISA bus **SL-PCAT**



CE

For PC/104 bus **SL-PC104**



CE

Open network compatible PLC

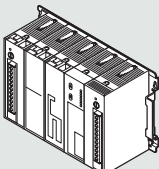

For CC-Link
SL-GU1-C



CE
CC-Link

For Device Net
SL-GU1-D



CE
DeviceNet.



SYSTEM LAYOUT

S-LINK I/O devices

1 • 2 channel I/O unit
SL-CH□(-PN)



CE

8 channel snap-connector I/O unit
SL-T8J(-PN), SL-TP8J(-PN)



CE

For e-con 8 channel snap-connector I/O unit
SL-T8E(-PN), SL-TP8E(-PN)



CE

16 channel MIL connector I/O unit
SL-T16C1(-PN), SL-TP16C1(-PN)



CE

8-branch connector tap
SL-T8PW



CE

I/O arrayed terminal unit
**SL-TB□(-PN), SL-TBP□(-PN)
SL-TBP□-TY**



CE 4, 8 or 16 inputs
4, 8 or 16 outputs

Relay output terminal unit
SL-TPR4, SL-TPR8

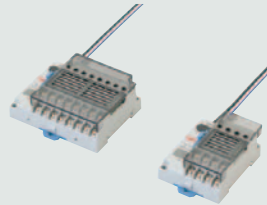

Snap-connector sensor block
SL-BMJ, SL-BXJ

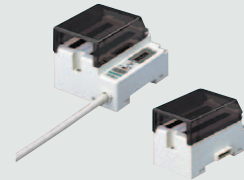

Plug-in unit sensor block
SL-BM, SL-BX



CE

S-LINK direct hook-up
photoelectric sensor
SL-A□



S-LINK direct hook-up
picking sensor
SL-N15



CE

Picking switch
SL-PK01



CE

Items offered by partner makers

Manifold electromagnetic valve
manufactured by Koganei Corp.

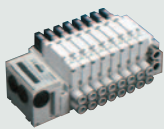

Manifold electromagnetic valve
manufactured by SMC Pneumatics

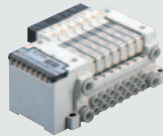

Manifold electromagnetic valve
manufactured by CKD Corp.

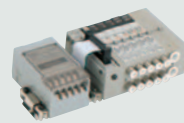

Component indicator lamp
manufactured by Yazaki
Industrial Chemical Co., Ltd.



FIBER
SENSORS

LASER
SENSORS

PHOTOELECTRIC
SENSORS

MICRO
PHOTOELECTRIC
SENSORS

AREA
SENSORS

LIGHT CURTAINS /
SAFETY
COMPONENTS

PRESSURE /
FLOW
SENSORS

INDUCTIVE
PROXIMITY
SENSORS

PARTICULAR
USE SENSORS

SENSOR
OPTIONS

SIMPLE
WIRE-SAVING
UNITS

WIRE-**SAVING**
SYSTEMS

MEASUREMENT
SENSORS

STATIC ELECTRICITY
PREVENTION
DEVICES

LASER
MARKERS

PLC

HUMAN MACHINE
INTERFACES

ENERGY CONSUMPTION
VISUALIZATION
COMPONENTS

FA COMPONENTS

MACHINE VISION
SYSTEMS

UV CURING
SYSTEMS

For Large
Scale Systems

For Medium
Scale Systems

S-LINK

Plug-in units (for SL-BM, SL-BX)

Amplifier-separated
photoelectric sensor
SU-7J



CE

Input terminal unit
SL-TJ1

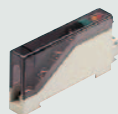

CE

SYSTEM LAYOUT

Connectors and cables

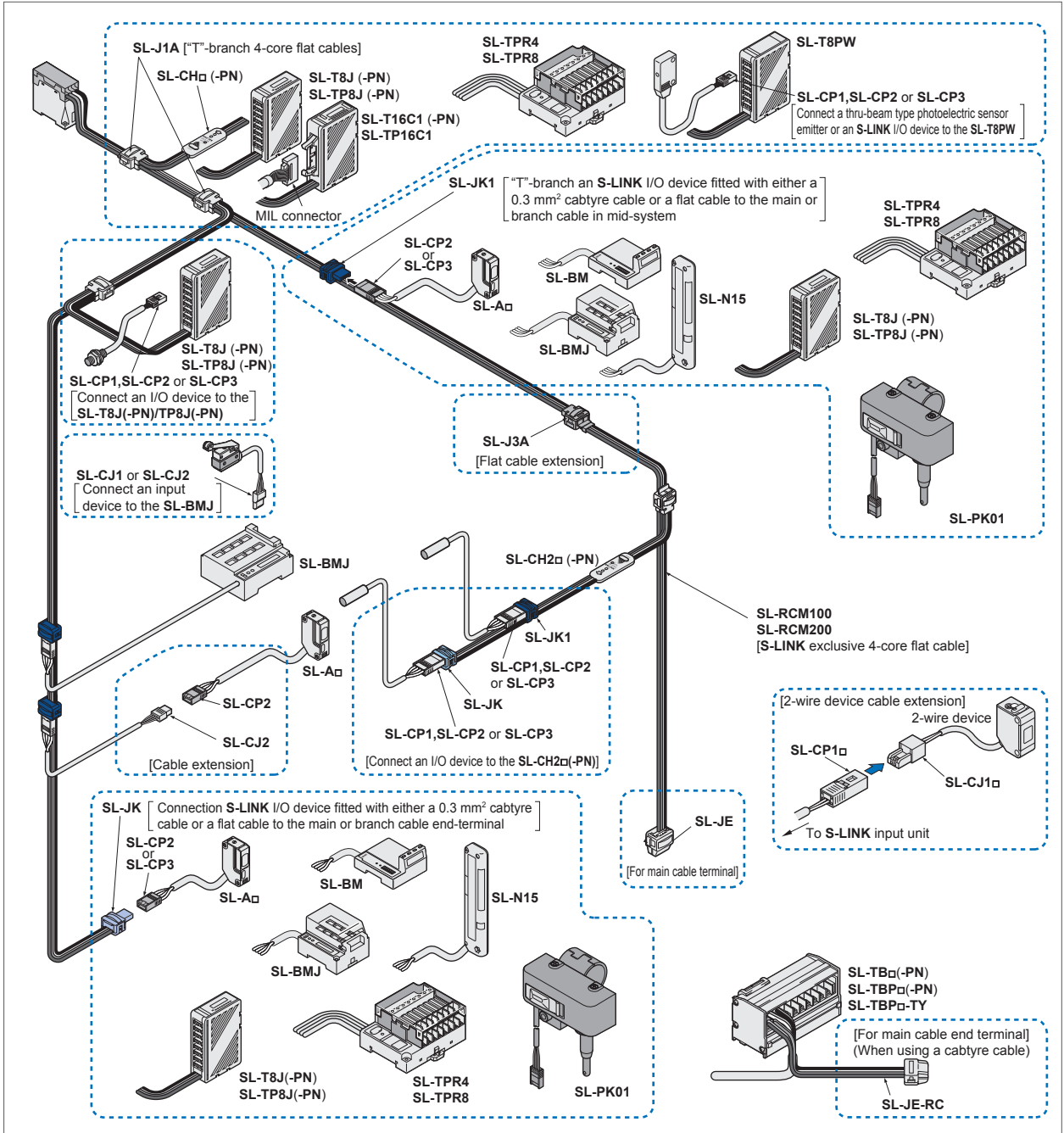

Other S-LINK devices

I/O modules
SL-M□, SL-M□F
 8 or 16 inputs
 8 or 16 outputs
 4 inputs and 4 outputs

Handy monitor
SL-HM1











- FIBER SENSORS
- LASER SENSORS
- PHOTOELECTRIC SENSORS
- MICRO PHOTOELECTRIC SENSORS
- AREA SENSORS
- LIGHT CURTAINS / SAFETY COMPONENTS
- PRESSURE / FLOW SENSORS
- INDUCTIVE PROXIMITY SENSORS
- PARTICULAR USE SENSORS
- SENSOR OPTIONS
- SIMPLE WIRE-SAVING UNITS
- WIRE-SAVING SYSTEMS
- MEASUREMENT SENSORS
- STATIC ELECTRICITY PREVENTION DEVICES
- LASER MARKERS
- PLC
- HUMAN MACHINE INTERFACES
- ENERGY CONSUMPTION VISUALIZATION COMPONENTS
- FA COMPONENTS
- MACHINE VISION SYSTEMS
- UV CURING SYSTEMS

For Large Scale Systems
 For Medium Scale Systems

S-LINK

ORDER GUIDE**S-LINK control units**

Designation	Appearance (Note)	Model No.	Description
S-LINK controller	 CE	SL-CU1A	It supplies the synchronization signal to the complete system to send and receive I/O data from external devices correctly. It also monitors the signal transmission line, and specifies the addresses of the disconnected devices if the line breaks, etc.
FPΣ S-LINK unit		FPG-SL (AFP780)	It controls the S-LINK system by directly connecting to the FPΣ series.
FP0 S-LINK Control unit		FP0-SL1 (AFP02700)	It controls the S-LINK system by directly connecting to the FP0 series.
FP2SH S-LINK unit		FP2-SL2 (AFP2780)	It controls the S-LINK system by directly connecting to the FP2SH series.
Mitsubishi Electric PLC bus S-LINK controller	 CE	SL-MEL-Q	It can be directly connected to the bus line of the MELSEC-Q series PLC manufactured by Mitsubishi Electric Corp. (Has S-LINK controller as well as PLC input and output connector functions so you don't have to prepare for these items. Also, it doesn't need a PLC input or output module.)
Yokogawa Electric PLC bus S-LINK controller	 CE	SL-FAM3	It can be directly connected to the bus line of the FA-M3 series PLC manufactured by Yokogawa Electric Corp. (Has S-LINK controller as well as PLC input and output connector functions so you don't have to prepare for these items. Also, it doesn't need a PLC input or output module.)
PC/AT S-LINK control board	 CE	SL-PCAT	It can be fitted into the expansion slot (ISA bus) of PC/AT series or compatible to control the S-LINK system. (Has S-LINK controller as well as PLC input and output connector functions so you don't have to prepare for these items.)
PC/104 bus S-LINK control board	 CE	SL-PC104	Controls the S-LINK system by directly coupling (stack) the PC/104 bus line to a PC/104 bus compatible PC board or panel computer. (Has S-LINK controller as well as PLC input and output connector functions so you don't have to prepare for these items.)

Note: Components with "CE" mark conform to the CE marking EMC Directive.

The following condition must be met to conform to EN 61000-6-2.

• **Conditions**

- ① Cable length between the main power supply and the **S-LINK** control unit should be less than 10 m 32.808 ft.
- ② When the power is supplied from **S-LINK** control unit to **S-LINK** I/O devices at a cable distance of more than 10 m 32.808 ft add a surge absorber between 24 V and 0 V at a cable distance of less than 10 m 32.808 ft, or use a local power supply at a cable distance of less than 10 m 32.808 ft from each **S-LINK** I/O device.

FIBER
SENSORSLASER
SENSORSPHOTO-
ELECTRIC
SENSORSMICRO
PHOTO-
ELECTRIC
SENSORSAREA
SENSORSLIGHT
CURTAINS /
SAFETY
COMPONENTSPRESSURE /
FLOW
SENSORSINDUCTIVE
PROXIMITY
SENSORSPARTICULAR
USE
SENSORSSENSOR
OPTIONSSIMPLE
WIRE-SAVING
UNITSWIRE-SAVING
SYSTEMSMEASURE-
MENT
SENSORSSTATIC
ELECTRICITY
PREVENTION
DEVICESLASER
MARKERS



PLC

HUMAN
MACHINE
INTERFACESENERGY
CONSUMPTION
VISUALIZATION
COMPONENTSFA
COMPONENTSMACHINE
VISION
SYSTEMSUV
CURING
SYSTEMSFor Large Scale
SystemsFor Medium
Scale Systems**S-LINK**

FIBER SENSORS
LASER SENSORS
PHOTO-ELECTRIC SENSORS
MICRO PHOTO-ELECTRIC SENSORS
AREA SENSORS
LIGHT CURTAINS / SAFETY COMPONENTS
PRESSURE / FLOW SENSORS
INDUCTIVE PROXIMITY SENSORS
PARTICULAR USE SENSORS
SENSOR OPTIONS
SIMPLE WIRE-SAVING UNITS
WIRE-SAVING SYSTEMS
MEASUREMENT SENSORS
STATIC ELECTRICITY PREVENTION DEVICES
LASER MARKERS
PLC
HUMAN MACHINE INTERFACES
ENERGY CONSUMPTION VISUALIZATION COMPONENTS
FA COMPONENTS
MACHINE VISION SYSTEMS
UV CURING SYSTEMS

ORDER GUIDE

Products for open network

Designation	Appearance (Note)	Model No.	Description
S-LINK gateway controller for CC-Link	 CE	SL-GU1-C	S-LINK gateway controller for connection to open network CC-Link, promoted by Mitsubishi Electric Corp.
S-LINK gateway controller for DeviceNet	 CE	SL-GU1-D	S-LINK gateway controller for connection to open network DeviceNet. * The SL-GU1-D will be discontinued at the end of September, 2015.

Note: Components with "CE" mark conform to the CE marking EMC Directive.
The following condition must be met to conform to EN 61000-6-2.

• **Conditions**

- ① Cable length between the main power supply and the **S-LINK** control unit should be less than 10 m **32.808 ft**.
- ② When the power is supplied from **S-LINK** control unit to **S-LINK** I/O devices at a cable distance of more than 10 m **32.808 ft** add a surge absorber between 24 V and 0 V at a cable distance of less than 10 m **32.808 ft**, or use a local power supply at a cable distance of less than 10 m **32.808 ft** from each **S-LINK** I/O device.



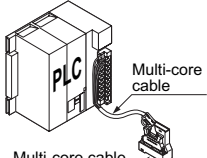
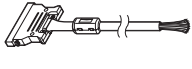

PLC related units

Designation	Appearance (Note 1)	Model No.		Description
		For input	For output	
Multi-core cable PLC I/O unit		SL-S	SL-P	This is the Multi-core cable PLC I/O unit for connecting the screw-on terminal type PLC with the S-LINK system. Interfaces I/O data between the S-LINK controller and PLC. It includes the I/O data conversion circuit for serial to parallel or parallel to serial conversion. I/O points: 32 points per unit Connection to screw-on terminal type PLC is by an optional multi-core cable attached with an MIL connector on one end.
		SL-SP	SL-PP	
Multi-core cable		SL-L2000F	Length: 2 m 6.562 ft	The multi-core cable attached with an MIL connector on one end links the multi-core cable PLC I/O unit to a screw-on terminal type PLC I/O module.

- Notes: 1) Components with "CE" mark conform to the CE marking EMC Directive.
However, note that for the multi-core cable PLC I/O units to conform to CE marking EMC Directive, it is necessary to use cascade cable **SL-F70**, **SL-F150** or **SL-F250**, control cable **SL-C2000F** and multi-core cable **SL-L2000F**.
- 2) In case the output circuit of the PLC output module contains capacitive components for improving the noise characteristics, since it is possible that the multi-core cable PLC output units **SL-P**, **SL-PP** may not be able to receive the signal correctly, please use output modules which have an output circuit capacitance of 0.01 μF or less.
- 3) Since the multi-core cable PLC output units **SL-P**, **SL-PP** are high input impedance, time division input type devices, please use PLC output modules whose output circuit can operate at a load current of even 0.1 mA.

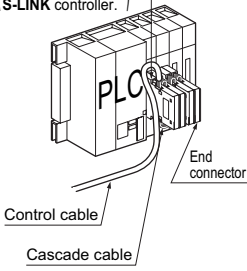
For Large Scale Systems
For Medium Scale Systems

ORDER GUIDE**PLC related units**

Designation	Appearance (Note 1)	Model No.		Description			
		For input	For output	Manufacturer	PLC	PLC input module (Note 4)	PLC output module (Note 4)
PLC input connector PLC output connector	<p>Fujitsu Component connector specs. MIL connector specs.</p>  <p>PLC input connectors PLC output connectors (same shape) (Note 2)</p> <p>The listed PLC I/O modules (NPN I/O type) allow the mating PLC I/O connector to be plugged on them for signal transmission between the PLC and the S-LINK controller.</p> <p>(The PLC I/O connector converts I/O data from serial to parallel, and vice versa. I/O points: 32 points per connector)</p> <p>Max. four PLC I/O connectors can be cascaded with one S-LINK controller.</p>  <p>Control cable Cascade cable</p>	SL-S1	SL-P1	Panasonic Industrial Devices SUNX Co., Ltd. Toshiba Machine Co., Ltd.	FPΣ (Excluding the FPG-C32T) FP2 TC200	FPG-XY64D2T (X side) FP2-X32D2 TC64DI	FPG-XY64D2T (Y side) FP2-Y32T TC64DON
				Fuji Electric FA Components & Systems Co., Ltd.	NS series	NS-X64-1 NS-XY64-1 (X side)	NS-XY64-1 (Y side)
					F55	NV1X3204 NV1X3204-W NV1X3206	NV1Y32T05P1
					F70	NC1X3204 NC1X3204-3 NC1X3206 NC1X6404 NC1X6406 NC1W6406T (X side)	NC1Y32T05P1 NC1Y64T05P1-1 NC1W6406T (Y side)
					F80H, F120H F120S F140S F15XS	FTU125A FTU126A FTU127C FTU612A (X side)	FTU222A FTU227C FTU612A (Y side)
				Fuji Electric FA Components & Systems Co., Ltd.	SX series SPH	NP1X3206-W NP1X6406-W	NP1Y32T09P1 NP1Y64T09P1
					AnS	A1SX41 A1SX42 A1SH42 (X side)	A1SY41 A1SY42 A1SH42 (Y side)
					AnN, AnA AnU, QnA QnAs	AX42 AH42 (X side)	AY42 AH42 (Y side)
					Q	QX41, QX42	QY41P, QY42P
				Mitsubishi Electric Corp.	A2CJ	AJ35TC1-32D	AJ35TC1-32T
				Sharp Manufacturing Systems Corp.	JW20, JW20H JW30H	JW-234N JW-264N	JW-232S JW-262S
					JW50H	JW-34NC JW-64NC	JW-32SC JW-62SC
				Omron Corp.	CJ1	CJ1W-ID231 CJ1W-ID261 CJ1W-MD261 (X side)	CJ1W-OD231 CJ1W-OD261 CJ1W-MD261 (Y side)
						CS1	CS1W-ID231 CS1W-ID261 CS1W-MD261 (X side)
CVM1, CV C500 C1000H C2000H	C500-ID219	C500-OD213					
C200H series	C200H-ID216 C200H-ID217	C200H-OD218 C200H-OD219					
	CQM1	CQM1-ID213	CQM1-OD213				
Hitachi Ltd.	EH-150	EH-XD32 EH-YT32					
Yokogawa Electric Corp.	FA500	XD64-6N WD64-6N (X side)	YD64-1A WD64-6N (Y side)				
	FA-M3	F3XD32-3N F3XD64-3N	F3YD32-1A F3YD64-1A				
Toshiba Corp.	T3	DI-335 DI-335H	DO-335				
Yasukawa Electric Corp.	GL20, GL40S GL60S, GL60H GL70H	—	B2604				
SL-S6	SL-P6	Hitachi Ltd.	H series		XDC24D2H	YTR24DH	
SL-S7	—	Yasukawa Electric Corp.	GL20, GL40S GL60S, GL60H GL70H		B2605	—	
End connector		SL-E	It must be connected at the end of the last PLC I/O connector.				
Cascade cable		SL-F70	Length: 70 mm	2.756 in	It links PLC input / PLC output connectors.		
		SL-F150	Length: 150 mm	5.906 in			
		SL-F250	Length: 250 mm	9.843 in			
		SL-F1000	Length: 1,000 mm	39.370 in			
Control cable		SL-C1000	Length: 1 m	3.281 ft	It links the S-LINK controller and the first PLC I/O connector.		
		SL-C2000	Length: 2 m	6.562 ft			
		SL-C5000	Length: 5 m	16.404 ft			
		SL-C2000F	Length: 2 m	6.562 ft			

Notes: 1) Components with "CE" mark conform to the CE marking EMC Directive.

However, note that for the PLC I/O connectors to conform to CE marking EMC Directive, it is necessary to use cascade cable **SL-F70**,**SL-F150** or **SL-F250** and control cable **SL-C2000F**.2) The PLC I/O connectors use Fujitsu connectors. However, **SL-S1**, **SL-S6**, **SL-P1** and **SL-P6** connectors use MIL connectors.3) PLC I/O connectors are connectable to **S-LINK** controller **SL-CU1A** only.







4) X side and Y side indicate the input and the output connectors, respectively, of the compound input / output module.

FIBER
SENSORSLASER
SENSORSPHOTO-
ELECTRIC
SENSORSMICRO
PHOTO-
ELECTRIC
SENSORSAREA
SENSORSLIGHT
CURTAINS /
SAFETY
COMPONENTSPRESSURE /
FLOW
SENSORSINDUCTIVE
PROXIMITY
SENSORSPARTICULAR
USE
SENSORSSENSOR
OPTIONSSIMPLE
WIRE-SAVING
UNITSWIRE-SAVING
SYSTEMSMEASURE-
MENT
SENSORSSTATIC
ELECTRICITY
PREVENTION
DEVICESLASER
MARKERS

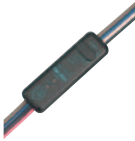
PLC

HUMAN
MACHINE
INTERFACESENERGY
CONSUMPTION
VISUALIZATION
COMPONENTSFA
COMPONENTSMACHINE
VISION
SYSTEMSUV
CURING
SYSTEMSFor Large Scale
SystemsFor Medium
Scale Systems**S-LINK**

ORDER GUIDE**S-LINK I/O devices**

Designation	Appearance (Note)	Model No.		Description
1 channel I/O unit		SL-CH1	NPN type	It can be used as either an input unit or an output unit by switch selection. Signals, such as from the sensor and limit switch, can be transmitted by the signal transmission line. These signals from the signal transmission line can turn ON / OFF the transistor output.
		SL-CH1-PN	PNP type	
2 channel I/O mixed unit		SL-CH21	NPN type	1 input and 1 output are equipped. 1 input device and 1 output device are connectable.
		SL-CH21-PN	PNP type	
2 channel input unit		SL-CH20	NPN type	2 input devices are connectable.
		SL-CH20-PN	PNP type	
2 channel output unit		SL-CH22	NPN type	2 output devices are connectable.
		SL-CH22-PN	PNP type	
8 channel snap-connector input unit		SL-T8J	8 NPN inputs	8 input or 8 output devices are connectable with snap male connectors. The output unit is incorporated with an output signal hold function, which retains the output state just prior to an error on the signal transmission line.
		SL-T8J-PN	8 PNP inputs	
		SL-TP8J	8 NPN outputs	
		SL-TP8J-PN	8 PNP outputs	
16 channel MIL connector input unit		SL-T16C1	16 NPN inputs	Since connection can be made with an MIL connector, 16 input or 16 output devices can be connected to this slim I/O unit. The output unit is incorporated with an output signal hold function, which retains the output state just prior to an error on the signal transmission line.
		SL-T16C1-PN	16 PNP inputs	
		SL-TP16C1	16 NPN outputs	
		SL-TP16C1-PN	16 PNP outputs	
8 channel snap-connector input unit		SL-T8E	8 NPN inputs	Up to 8 input or output devices can be easily connected via e-CON. Also, when there is an abnormality in the signal communication line, the output status just before the abnormality can be preserved since the output unit is equipped with an output hold function. *For the connector, please separately purchase a commercial product which supports e-CON standards.
		SL-T8E-PN	8 PNP inputs	
		SL-TP8E	8 NPN outputs	
		SL-TP8E-PN	8 PNP outputs	

Note: Components with "CE" mark conform to the CE marking EMC Directive.

FIBER SENSORS

LASER SENSORS

PHOTO-ELECTRIC SENSORS

MICRO PHOTO-ELECTRIC SENSORS

AREA SENSORS

LIGHT CURTAINS / SAFETY COMPONENTS

PRESSURE / FLOW SENSORS

INDUCTIVE PROXIMITY SENSORS

PARTICULAR USE SENSORS

SENSOR OPTIONS

SIMPLE WIRE-SAVING UNITS

WIRE-SAVING SYSTEMS

MEASUREMENT SENSORS

STATIC ELECTRICITY PREVENTION DEVICES

LASER MARKERS

PLC

HUMAN MACHINE INTERFACES

ENERGY CONSUMPTION VISUALIZATION COMPONENTS

FA COMPONENTS

MACHINE VISION SYSTEMS



UV CURRING SYSTEMS

For Large Scale Systems

For Medium Scale Systems

S-LINK

ORDER GUIDE**S-LINK I/O devices**

Designation	Appearance (Note 1)	Model No.	Description
I/O arrayed terminal unit		SL-TB4	4 NPN inputs
		SL-TB4-PN	4 PNP inputs
		SL-TB8	8 NPN inputs
		SL-TB8-PN	8 PNP inputs
		SL-TB16	16 NPN inputs
		SL-TB16-PN	16 PNP inputs
		SL-TBP4	4 NPN outputs
		SL-TBP4-PN	4 PNP outputs
		SL-TBP8	8 NPN outputs
		SL-TBP8-PN	8 PNP outputs
		SL-TBP16	16 NPN outputs
		SL-TBP16-PN	16 PNP outputs
	Separate load power supply type	SL-TBP4-TY	4 NPN outputs
		SL-TBP8-TY	8 NPN outputs
Relay output terminal unit		SL-TPR4	4 outputs (Note 2)
		SL-TPR8	8 outputs (Note 2)

Notes: 1) Components with "CE" mark conform to the CE marking EMC Directive.

2) Relay output is "Contact a" only. Further, when replacing the relay, use PA relay (APA3312) manufactured by Panasonic Corporation.









FIBER
SENSORSLASER
SENSORSPHOTO-
ELECTRIC
SENSORSMICRO
PHOTO-
ELECTRIC
SENSORSAREA
SENSORSLIGHT
CURTAINS /
SAFETY
COMPONENTSPRESSURE /
FLOW
SENSORSINDUCTIVE
PROXIMITY
SENSORSPARTICULAR
USE
SENSORSSENSOR
OPTIONSSIMPLE
WIRE-SAVING
UNITSWIRE-SAVING
SYSTEMSMEASURE-
MENT
SENSORSSTATIC
ELECTRICITY
PREVENTION
DEVICESLASER
MARKERS

PLC

HUMAN
MACHINE
INTERFACESENERGY
CONSUMPTION
VISUALIZATION
COMPONENTSFA
COMPONENTSMACHINE
VISION
SYSTEMSUV
CURING
SYSTEMSFor Large Scale
SystemsFor Medium
Scale Systems**S-LINK**

ORDER GUIDE

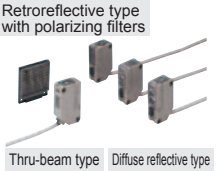
S-LINK I/O devices











Designation	Appearance (Note)	Model No.	Description	
Sensor block	Snap-connector	Sensor main block	 <p>SL-BMJ</p> <p>It allows connection of various kinds of input devices, such as, photoelectric sensors, inductive proximity sensors, limit switches, and push buttons with the snap female connectors. Changes signals from input devices into serial signals and transmits them to the signal transmission line. One SL-BMJ can be extended by one SL-BXJ or two SL-BXs, up to 16 input points. (It can generate the ORed self-diagnosis output of all the connected devices.) (In this case, the first channel gets occupied.)</p>	
		Extension block	 <p>SL-BXJ</p> <p>It can follow either main block, and allows connection of 8 input devices.</p>	
	For plug-in unit	Sensor main block	 <p>SL-BM</p> <p>It allows connection of various kinds of plug-in units and changes signals from plug-in units into serial signals and transmits them to the signal transmission line. One SL-BM can be extended by three SL-BXs or one SL-BX plus one SL-BXJ, up to 16 input points. (It can generate the ORed self-diagnosis output of all connected units. In this)</p>	
		Extension block	 <p>SL-BX</p> <p>It can follow either main block, and allows connection of four plug-in units.</p>	
Plug-in unit	Amplifier-separated photoelectric sensor	 <p>SU-7J</p> <p>Its thickness is merely 10 mm 0.394 in. The sensitivity is automatically set with ease.12 kinds of sensor heads are suitable with it. (For details, refer to the SU-7/SH series pages.)</p>		
	Input terminal unit	 <p>SL-TJ1</p> <p>It allows connection of 1 No. of various kinds of input devices, such as, a photoelectric sensor, an inductive proximity sensor or a limit switch.</p>		
S-LINK direct hook-up photoelectric sensor	 <p>Retroreflective type with polarizing filters</p> <p>Thru-beam type Diffuse reflective type</p>	SL-A11	Thru-beam type 10 m 32.808 ft	These can be hooked up to the S-LINK cable, at any place, without any interface.
		SL-A13	Thru-beam type 30 m 98.425 ft	
		SL-A19	Retroreflective type with polarizing filters 0.1 to 5 m 0.328 to 16.404 ft	
		SL-A12	Diffuse reflective type 700 mm 27.559 in	
S-LINK direct hook-up picking sensor	 <p>SL-N15</p> <p>Sensing range: 0.2 to 3 m 0.656 to 9.843 ft (0.05 to 1 m 0.164 to 3.281 ft when the switch is set to SHORT) Beam pitch: 25 mm 0.984 in Sensing height: 100 mm 3.937 in Sensing object: ø35 mm ø1.378 in or more opaque object</p>	<p>It is a parts-taking verification sensor with five sensing beams and can be hooked up to the S-LINK cable without any interface. Both the emitter and the receiver are incorporated with bright orange LED job indicators that are easily visible to the operator.</p>		
Picking switch	 <p>SL-PK01</p> <p>This picking switch can be installed on pipes. Its compact size (just 90 mm 3.543 in wide) allows it to be installed on small-sized shelving used with compact parts, while its cable with integrated connector and magnetic (Hall element) contactless switch simplify installation and provide freedom in terms of switch operation (back and forth, left and right, and vertically). Up to 64 units can be connected to a single S-LINK control unit.</p>			

Note: Components with "CE" mark conform to the CE marking EMC Directive.

- FIBER SENSORS
- LASER SENSORS
- PHOTO-ELECTRIC SENSORS
- MICRO PHOTO-ELECTRIC SENSORS
- AREA SENSORS
- LIGHT CURTAINS/ SAFETY COMPONENTS
- PRESSURE / FLOW SENSORS
- INDUCTIVE PROXIMITY SENSORS
- PARTICULAR USE SENSORS
- SENSOR OPTIONS
- SIMPLE WIRE-SAVING UNITS
- WIRE-SAVING SYSTEMS
- MEASURE-MENT SENSORS
- STATIC ELECTRICITY PREVENTION DEVICES
- LASER MARKERS
- PLC
- HUMAN MACHINE INTERFACES
- ENERGY CONSUMPTION VISUALIZATION COMPONENTS
- FA COMPONENTS
- MACHINE VISION SYSTEMS
- UV CURING SYSTEMS
- For Large Scale Systems
- For Medium Scale Systems
- S-LINK**

ORDER GUIDE

Connectors

Designation	Appearance	Model No.	Description
Hook-up connector	 (Note)	SL-J1A 10 pcs. per set	It creates a "T"-branch connection between two S-LINK exclusive flat cables (4-core). For 0.5 mm ² flat cable to 0.5 mm ² flat cable connection (Gray) Applicable hook-up pliers: SL-JPS, SL-JPD
Cable extension hook-up connector	 (Note)	SL-J3A 10 pcs. per set	It can extend the S-LINK exclusive flat cable (4-core). For 0.5 mm ² flat cable to 0.5 mm ² flat cable connection (Black) Applicable hook-up pliers: SL-JPS, SL-JPD
End hook-up connector	 (Note)	SL-JE 5 pcs. per set	It must be connected at the end of the main cable. For 0.5 mm ² flat cable (Gray) Applicable hook-up pliers: SL-JPS, SL-JPD
Cable attached end connector	 (Note)	SL-JE-RC 1 pc.	When cabtyre cable is used as the main cable, it must be connected at the end of the main cable.
Cable end socket-branch hook-up connector	 (Note)	SL-JK 10 pcs. per set	It enables one I/O device to be connected at the S-LINK exclusive 0.5 mm ² flat cable (4-core) end with the snap male connector (SL-CP□). (Light blue) Applicable hook-up pliers: SL-JPS, SL-JPD
"T"-branch hook-up connector	 (Note)	SL-JK1 10 pcs. per set	It enables one I/O device to be branched off in the middle of the S-LINK exclusive 0.5 mm ² flat cable (4-core) with the snap male connector (SL-CP□). (Blue) Applicable hook-up pliers: SL-JPS, SL-JPD
4-pin type snap female connector	 (Note)	SL-CJ1 (White) 10 pcs. per set	This snap female connector is used for plugging into the socket of SL-BMJ or SL-BXJ to connect an input device, or into the snap male connector SL-CP1 or SL-CP2 . Applicable hook-up pliers: SL-JPC
	 (Note)	SL-CJ2 (Black) 10 pcs. per set	
4-pin type snap male connector	 (Note)	SL-CP1 (White) 10 pcs. per set	This snap male connector is used for connecting S-LINK I/O devices to SL-T8J(-PN) and SL-TP8J(-PN) 8-channel snap-connector I/O units as well as to SL-JK and SL-JK1 hook-up connectors. Applicable hook-up pliers: SL-JPC (for the SL-CP1 and SL-CP2) SL-JPE (for the SL-CP3)
	 (Note)	SL-CP2 (Black) 10 pcs. per set	
	 (Note)	SL-CP3 (Greenish blue) 10 pcs. per set	

Note: For UL compatibility, please contact our office.

FIBER SENSORS

LASER SENSORS

PHOTO-ELECTRIC SENSORS

MICRO PHOTO-ELECTRIC SENSORS

AREA SENSORS

LIGHT CURTAINS / SAFETY COMPONENTS

PRESSURE / FLOW SENSORS

INDUCTIVE PROXIMITY SENSORS

PARTICULAR USE SENSORS

SENSOR OPTIONS

SIMPLE WIRE-SAVING UNITS

WIRE-SAVING SYSTEMS

MEASUREMENT SENSORS

STATIC ELECTRICITY PREVENTION DEVICES

LASER MARKERS

PLC

HUMAN MACHINE INTERFACES

ENERGY CONSUMPTION VISUALIZATION COMPONENTS

FA COMPONENTS

MACHINE VISION SYSTEMS

UV CURING SYSTEMS

For Large Scale Systems

For Medium Scale Systems

S-LINK

FIBER SENSORS

LASER SENSORS

PHOTO-ELECTRIC SENSORS

MICRO PHOTO-ELECTRIC SENSORS

AREA SENSORS

LIGHT CURTAINS / SAFETY COMPONENTS

PRESSURE / FLOW SENSORS

INDUCTIVE PROXIMITY SENSORS

PARTICULAR USE SENSORS

SENSOR OPTIONS

SIMPLE WIRE-SAVING UNITS

WIRE-SAVING SYSTEMS

MEASUREMENT SENSORS

STATIC ELECTRICITY PREVENTION DEVICES

LASER MARKERS

PLC

HUMAN MACHINE INTERFACES

ENERGY CONSUMPTION VISUALIZATION COMPONENTS

FA COMPONENTS

MACHINE VISION SYSTEMS

UV CURING SYSTEMS



For Large Scale Systems

For Medium Scale Systems



S-LINK

ORDER GUIDE

Basic units









Designation		Appearance	Model No.	Description	
I/O module	Vertical type		SL-M8	8 inputs	These are IC type modules which enable external connection of address setting switches and operation indicators. They increase the design flexibility.
			SL-M16	16 inputs	
			SL-M4P4	4 inputs and 4 outputs	
			SL-MP8	8 outputs	
	Horizontal type		SL-M8F	8 inputs	
			SL-M16F	16 inputs	
			SL-M4P4F	4 inputs and 4 outputs	
			SL-MP8F	8 outputs	
	Output module	SL-MP16F	16 outputs		

Optional units

Designation	Appearance	Model No.	Description
Booster	 CE	SL-BS1A	It can extend the signal transmission distance by 200 m 656.168 ft. A maximum of seven boosters can be connected for one S-LINK control unit. However, one booster can never be followed by another booster in series.
Handy monitor		SL-HM1	It can be connected at any place on the signal transmission line and the I/O states can be checked in batches of 16. The handy monitor is also incorporated with the S-LINK control functions, so that, for example, it can perform an I/O check on conveyor system segments, still under assembly, even without the S-LINK controller.

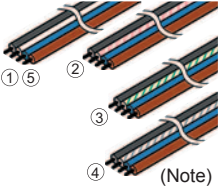
Note: Components with "CE" mark conform to the CE marking EMC Directive.

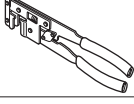
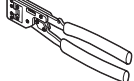
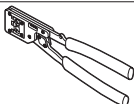
ORDER GUIDE**Others**

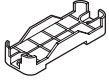
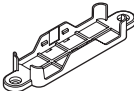
Designation	Appearance	Model No.	Description		
8-branch connector tap		SL-T8PW	Connects easily to up to 8 thru-beam type photoelectric sensor emitters or S-LINK I/O devices with snap male connectors.		
2-pin type snap female connector	 (Note)	SL-CJ12 (White) 10 pcs. per set	For 0.08 to 0.2 mm ² (Conductor cross-section area) Wire dia.: $\varnothing 0.7$ to $\varnothing 1.2$ mm $\varnothing 0.028$ to $\varnothing 0.047$ in	It can be used for cable extension of 2-wire I/O devices by combining with a 2-pin type snap male connector SL-CP \square 2. Applicable hook-up pliers: SL-JPC	
	 (Note)	SL-CJ22 (Black) 10 pcs. per set	For 0.3 mm ² (Conductor cross-section area) Wire dia.: $\varnothing 1.1$ to $\varnothing 1.6$ mm $\varnothing 0.043$ to $\varnothing 0.063$ in		
2-pin type snap male connector	 (Note)	SL-CP12 (White) 10 pcs. per set	For 0.08 to 0.2 mm ² (Conductor cross-section area) Wire dia.: $\varnothing 0.7$ to $\varnothing 1.2$ mm $\varnothing 0.028$ to $\varnothing 0.047$ in	It can be used for cable extension of 2-wire I/O devices by combining with a 2-pin type snap female connector SL-CJ \square 2. Applicable hook-up pliers: SL-JPC	
	 (Note)	SL-CP22 (Black) 10 pcs. per set	For 0.3 mm ² (Conductor cross-section area) Wire dia.: $\varnothing 1.1$ to $\varnothing 1.6$ mm $\varnothing 0.043$ to $\varnothing 0.063$ in		
Exclusive flat cable (4-core)		SL-RCM100	Length: 100 m 328.084 ft	S-LINK / S-LINK V exclusive flat cable (4-core) Conductor cross-section area: 0.5 mm ² Outer diameter: $\varnothing 2.5$ mm $\varnothing 0.098$ in $\times 4$	
		SL-RCM100-PK			D line: White ①
		SL-RCM100-GN			D line: White with pink stripe ②
		SL-RCM100-GY			D line: White with green stripe ③
		SL-RCM200			D line: White with gray stripe ④
			Length: 200 m 656.168 ft , D line: White ⑤		
Exclusive cabtyre cable (4-core)		SL-CBM100	Length: 100 m 328.084 ft	S-LINK / S-LINK V exclusive cabtyre cable (4-core) Conductor cross-section area: 0.5 mm ² Outer diameter: $\varnothing 7.4$ mm $\varnothing 0.291$ in (Hook-up connector cannot be used)	
		SL-CBM200	Length: 200 m 656.168 ft		
Exclusive pliers		SL-JPS	Hook-up connector (SL-J \square) can be connected in one grip.		
SL-CP3 exclusive pliers		SL-JPE	4-pin type snap male connector (SL-CP3) can be connected in one grip.		
Male / female connector exclusive pliers		SL-JPC	Snap female connector (SL-CJ1/CJ2 , SL-CJ11/CJ12) and snap male connector (SL-CP1/CP2 , SL-CP11/CP12) can be connected in one grip.		
Address label		SL-MA1-SET 4 sheets. per set	By sticking the labels on the respective S-LINK devices, the set addresses can be confirmed at one glance. SL-MA1-SET is available in white, pink, green and gray colors, as a 4-sheet set, and is convenient when used by matching the color with that of the S-LINK exclusive flat cable (100 m 328.084 ft type).		
DIN rail mounting bracket for SL-CH \square		MS-CH\times10 10 pcs. per set	Mounting bracket enabling the SL-CH \square (-PN) I/O units to be mounted onto a 35 mm 1.378 in width DIN rail. They can also be affixed with screws. (When affixing with screws, arrange two M4 pan-head screws separately.)		
I/O unit holder for SL-CH \square		MS-SLH 5 pcs. per set	It is used to mount the SL-CH \square (-PN) unit. (Please arrange two M4 pan-head screws separately.)		

Note: For UL compatibility, please contact our office.

FIBER SENSORS

LASER SENSORS

PHOTO-ELECTRIC SENSORS

MICRO PHOTO-ELECTRIC SENSORS

AREA SENSORS

LIGHT CURTAINS / SAFETY COMPONENTS

PRESSURE / FLOW SENSORS

INDUCTIVE PROXIMITY SENSORS

PARTICULAR USE SENSORS

SENSOR OPTIONS

SIMPLE WIRE-SAVING UNITS

WIRE-SAVING SYSTEMS

MEASUREMENT SENSORS

STATIC ELECTRICITY PREVENTION DEVICES

LASER MARKERS

PLC

HUMAN MACHINE INTERFACES

ENERGY CONSUMPTION VISUALIZATION COMPONENTS

FA COMPONENTS

MACHINE VISION SYSTEMS

UV CURING SYSTEMS

For Large Scale Systems

For Medium Scale Systems

S-LINK

FIBER SENSORS
 LASER SENSORS
 PHOTO-ELECTRIC SENSORS
 MICRO PHOTO-ELECTRIC SENSORS
 AREA SENSORS
 LIGHT CURTAINS / SAFETY COMPONENTS
 PRESSURE / FLOW SENSORS
 INDUCTIVE PROXIMITY SENSORS
 PARTICULAR USE SENSORS
 SENSOR OPTIONS
 SIMPLE WIRE-SAVING UNITS
 WIRE-SAVING SYSTEMS
 MEASUREMENT SENSORS
 STATIC ELECTRICITY PREVENTION DEVICES
 LASER MARKERS
 PLC
 HUMAN MACHINE INTERFACES
 ENERGY CONSUMPTION VISUALIZATION COMPONENTS
 FA COMPONENTS
 MACHINE VISION SYSTEMS
 UV CURING SYSTEMS

For Large Scale Systems
 For Medium Scale Systems

S-LINK

ORDER GUIDE

Accessories

• **NPS-CV**

(Protective cover for the **SL-CU1A**, **SL-BS1A** or **SL-CU1-485**)

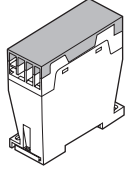

• **RF-230**

(Reflector for the **SL-A19**)



• **MS-SL-2**

(Mounting base for connector I/O units)

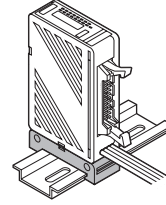

OPTIONS

Designation	Model No.	Description
Sensor mounting bracket for SL-A □	MS-NX5-1	Foot angled mounting bracket (The thru-beam type sensor needs two brackets.)
	MS-NX5-2	Foot biangled mounting bracket (sensor protection bracket) (The thru-beam type sensor needs two brackets.)
	MS-NX5-3	Back angled mounting bracket (The thru-beam type sensor needs two brackets.)
Sensor mounting bracket for SL-N15	MS-NA1-1	Four bracket set [Four M4 (length 15 mm 0.591 in) screws with washers, eight nuts, four hooks, four spacers and eight M4 (length 18 mm 0.709 in) screws with washers are attached. (Spacers are not attached with MS-NA1-1 .)
	MS-NA2-1	
Sensor protection bracket for SL-N15	MS-NA3	It protects the sensor body. Two bracket set (Silver) [Four M4 (length 15 mm 0.591 in) screws with washers, and four nuts are attached.]
	MS-NA3-BK	It protects the sensor body. Two bracket set (Black) [Four M4 (length 15 mm 0.591 in) screws with washers, and four nuts are attached.]
Reflector mounting bracket	MS-RF23	Reflector mounting bracket for RF-230
Slit mask for SL-N15	OS-NA1-5 10 sheets. per set	The seal type slit mask restrains the amount of beam emitted or received. (Take care that the sensing range will be reduced when the slit mask is used.)
Connector I/O unit mounting bracket, 8-branch connector tap mounting bracket	MS-DIN-3	It is a DIN rail mounting bracket which can be fitted on the mounting base of SL-T8J , SL-TP8J , SL-T16C1 , SL-TP16C1 and SL-T8PW .
DIN rail adapter	MS-DIN-IDC	This adapter is used when mounting the SL-GU1 □ to the 35 mm 1.378 in width DIN rail.

Sensor mounting bracket for **SL-A**□

• **MS-NX5-1**

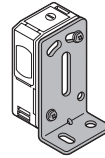

Two M4 (length 25 mm 0.984 in) screws with washers and two M4 nuts are attached.

• **MS-NX5-2**

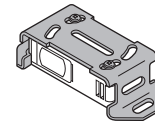

Two M4 (length 25 mm 0.984 in) screws with washers and two M4 nuts are attached.

• **MS-NX5-3**

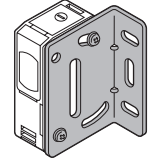

Two M4 (length 25 mm 0.984 in) screws with washers and two M4 nuts are attached.

Sensor mounting bracket for **SL-N15**

• **MS-NA1-1**

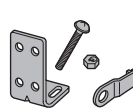

M4 screws with washers, nuts and hooks are attached.

• **MS-NA2-1**

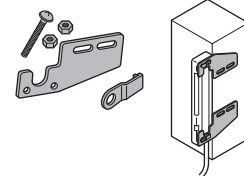

M4 screws with washers, nuts, hooks and spacers are attached.

Sensor protection bracket for **SL-N15**

• **MS-NA3**

• **MS-NA3-BK**

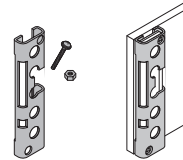

M4 screws with washers and nuts are attached.

Reflector mounting bracket

• **MS-RF23**

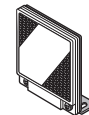

Two M4 (length 10 mm 0.394 in) screws with washers are attached.

DIN rail adapter

• **MS-DIN-IDC**

Two M4 (length 12 mm 0.472 in) screws with washers
(Two pcs. are attached with the DIN rail adapter)

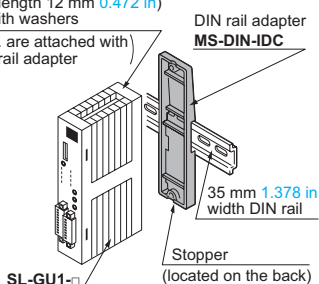

Slit mask for **SL-N15**

• **OS-NA1-5**

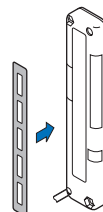

Connector I/O unit mounting bracket, 8-branch connector tap mounting bracket

• **MS-DIN-3**

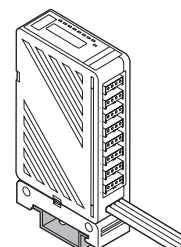

PRECAUTIONS FOR PROPER USE



- Never use this product in a device for personal protection.
- In case of using sensing devices for personnel protection, use products which meet laws and standards, such as OSHA, ANSI or IEC etc., for personnel protection applicable in each region or country.
- Handle safety related or emergency stop signals without passing them through the **S-LINK** system due to fail-safe considerations.
- Before touching this product, remove any electrostatic charge that may be present on your body. There is a danger of this product getting damaged due to the electrostatic charge.

The sensor & wire-saving link system **S-LINK** are not mutually interchangeable with the flexible wire-saving system **S-LINK V** and cannot be mixed or matched. Please exercise caution.

Nevertheless, any of the exclusive 4-core flat cable, connectors, hook-up pliers, or **SL-T8PW** 8-branch connector taps can be used.

Information about S-LINK partner makers | Refer directly to our partner makers for more details pertaining to the S-LINK compatible devices introduced here.

[Controllers suitable for S-LINK]

JTEKT Corp.



[S-LINK direct hook-up I/O devices]

Component indicator lamp
Yazaki Industrial Chemical Co., Ltd.



Manifold electromagnetic valves
Koganei Corp.

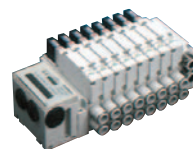

Manifold electromagnetic valves
SMC Pneumatics



Manifold electromagnetic valves
CKD Corp.

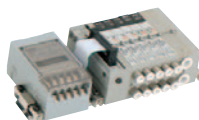

Information about the “Design Manual” and “Construction Manual” for the S-LINK sensor & wire-saving link system

We have two manuals available with more detailed information pertaining to the S-LINK sensor & wire-saving link system. Please contact our office for details.



S-LINK Design Manual

Holds information necessary when designing the layout for the **S-LINK** system. Refer to it for specifications and for illustration showing exterior dimensions.



S-LINK Construction Manual

Holds information necessary when introducing, constructing, and activating the **S-LINK** system. Refer to it for construction or startup cautionary items.

- FIBER SENSORS
- LASER SENSORS
- PHOTO-ELECTRIC SENSORS
- MICRO PHOTO-ELECTRIC SENSORS
- AREA SENSORS
- LIGHT CURTAINS / SAFETY COMPONENTS
- PRESSURE / FLOW SENSORS
- INDUCTIVE PROXIMITY SENSORS
- PARTICULAR USE SENSORS
- SENSOR OPTIONS
- SMILE WIRE-SAVING UNITS
- WIRE-SAVING SYSTEMS
- MEASURE-MENT SENSORS
- STATIC ELECTRICITY PREVENTION DEVICES
- LASER MARKERS
- PLC
- HUMAN MACHINE INTERFACES
- ENERGY CONSUMPTION VISUALIZATION COMPONENTS
- FA COMPONENTS
- MACHINE VISION SYSTEMS
- UV CURING SYSTEMS

For Large Scale Systems
For Medium Scale Systems

S-LINK