

Specification

Drawing No.	TKY1D-H2-19558-00[43] [1/9]
Issued Date.	Dec-11-2019

TO: Digi-Key

Note: In case of specification change, KYOCERA Part Number also will be changed.





Product Name	Crystal Oscillator
Product Model	_____
Frequency	**.**MHz
Customer Part Number	_____
Customer Specification Number	_____
KYOCERA Part Number	KC3225Z**.**C1KX00
Remarks	RoHS Compliant / MSL 1 /

Customer Acceptance

Accept Signature	Accept Date	
	Department	
	Person in charge	

Seller
 KYOCERA Corporation
 Corporate Electronic Components Group
 Electronic Components Sales Division
 6 Takeda Tobadono-cho, Fushimi-ku, Kyoto
 612-8501 Japan
 TEL. No. 075-604-3500
 FAX. No. 075-604-3501

Manufacturer
 KYOCERA Corporation
 Corporate Electronic Components Group
 Crystal Components Division
 Yamagata higashine Plant
 5850, Higashine-koh, Higashine-shi, Yamagata
 999-3701 Japan
 TEL. No. 0237-43-5611
 FAX. No. 0237-43-5615

Design Department KYOCERA Corporation Crystal Components Division	Quality Assurance	Approved by	Checked by	Issued by
				

1. Scope

This specification shall be defined of the Clock Oscillator for the integrated circuits (ICs).

2. Customer Part Number**3. KYOCERA Part Number****KC3225Z**.****C1KX00****4. Electrical Characteristics****4-1. Absolute Maximum Rating**

Item	Symbol	Rated Value	Units
Power Supply Voltage	V_{CC}	-0.3 to +4.5	V
Input Voltage	V_{IN}	-0.3 to $V_{CC} + 0.3$	V
Storage Temperature	T_{STG}	-55 to +150	°C

Note:

If the part is used beyond absolute maximum ratings, it may cause internal destruction. The part should be used under the recommended operating conditions the reliability of this part may be damaged if those conditions are exceeded.

4-2. Recommended Operating Conditions

Item	Symbol	Min	Typ	Max	Units	Remarks
Power Supply Voltage	V_{CC}	1.71	3.3	3.63	V	
Input Voltage	V_{IN}	0	---	V_{CC}	V	
Operating Temperature	T_{OPR}	-40	+25	+85	°C	

4-3. Electrical Characteristics

Item	Symbol	Min	Typ	Max	Units	Remarks
Output Frequency	F_O	0.5	** ****	170	MHz	
Frequency Tolerance*	F_{tol}	-20	---	+20	ppm	
Current Consumption (No Load/ $1.71 \leq V_{CC} \leq 2.25V$)		---	---	5.2		$0.5 \leq f_o < 5MHz$
		---	---	5.8		$5 \leq f_o < 15MHz$
		---	---	6.2		$15 \leq f_o < 30MHz$
		---	---	6.8		$30 \leq f_o < 50MHz$
		---	---	6.8		$50 \leq f_o \leq 60MHz$
		---	---	9		$60 < f_o < 75MHz$
		---	---	10		$75 \leq f_o < 105MHz$
		---	---	10.5		$105 \leq f_o < 130MHz$
		---	---	11.5		$130 \leq f_o < 160MHz$
		---	---	12.5		$160 \leq f_o \leq 170MHz$
Current Consumption (No Load/ $2.25 < V_{CC} \leq 2.8V$)	I_{CC}	---	---	5.5	mA	$0.5 \leq f_o < 5MHz$
		---	---	6		$5 \leq f_o < 15MHz$
		---	---	6.5		$15 \leq f_o < 30MHz$
		---	---	7.2		$30 \leq f_o < 50MHz$
		---	---	7.4		$50 \leq f_o \leq 60MHz$
		---	---	10		$60 < f_o < 75MHz$
		---	---	11.5		$75 \leq f_o < 105MHz$
		---	---	12.5		$105 \leq f_o < 130MHz$
		---	---	14		$130 \leq f_o < 160MHz$
		---	---	15		$160 \leq f_o \leq 170MHz$
Current Consumption (No Load/ $2.8 < V_{CC} \leq 3.63V$)		---	---	5.8		$0.5 \leq f_o < 5MHz$
		---	---	6.5		$5 \leq f_o < 15MHz$
		---	---	7.3		$15 \leq f_o < 30MHz$
		---	---	8		$30 \leq f_o < 50MHz$
		---	---	8.5		$50 \leq f_o \leq 60MHz$
		---	---	12.5		$60 < f_o < 75MHz$
		---	---	14.5		$75 \leq f_o < 105MHz$
		---	---	15.5		$105 \leq f_o < 130MHz$
		---	---	18		$130 \leq f_o < 160MHz$
		---	---	19.5		$160 \leq f_o \leq 170MHz$
Standby Current	I_{ST}	---	---	5	μA	
Symmetry (Duty Ratio)	SYM	45	50	55	%	@ 50% V_{CC}

Item	Symbol	Min	Typ	Max	Units	Remarks	
Rise Time/ Fall Time (20% V _{CC} to 80% V _{CC}) Loaded	Tr/ Tf	---	---	4	ns	0.5 ≤ f _o ≤ 60MHz	1.71 ≤ V _{CC} ≤ 2.25V
		---	---	3			2.25 < V _{CC} ≤ 2.8V
		---	---	2.5			2.8 < V _{CC} ≤ 3.63V
		---	---	1.5		60 < f _o ≤ 170MHz	1.71 ≤ V _{CC} ≤ 2.25V
		---	---	1.3			2.25 < V _{CC} ≤ 2.8V
		---	---	1			2.8 < V _{CC} ≤ 3.63V
Output Voltage-"L"	V _{OL}	---	---	10% V _{CC}	V	I _{OL} = 4mA	
Output Voltage-"H"	V _{OH}	90% V _{CC}	---	---	V	I _{OH} = -4mA	
Output Load	CL	---	---	15	pF	CMOS	
Input Voltage-"L"	V _{IL}	---	---	30% V _{CC}	V		
Input Voltage-"H"	V _{IH}	70% V _{CC}	---	---			
Output Disable Time	t _{dis}	---	---	200	ns		
Output Enable Time	t _{ena}	---	---	5	ms		
Start-up Time	t _{sta}	---	---	5	ms	@Minimum operating voltage to be 0sec	
1 Sigma Jitter**	J _{Sigma}	---	---	14	ps	10 ≤ f _o < 25MHz	
		---	---	12		25 ≤ f _o < 50MHz	
		---	---	10		50 ≤ f _o < 75MHz	
		---	---	14		75 ≤ f _o < 125MHz	
		---	---	18		125 ≤ f _o ≤ 170MHz	
Peak to Peak Jitter**	J _{PK-PK}	---	---	110	ps	10 ≤ f _o < 25MHz	
		---	---	95		25 ≤ f _o < 50MHz	
		---	---	80		50 ≤ f _o < 75MHz	
		---	---	75		75 ≤ f _o < 125MHz	
		---	---	100		125 ≤ f _o ≤ 170MHz	
Phase Jitter (BW: 12kHz to 20MHz)	---	---	---	33	ps	V _{CC} = 1.8V	10 ≤ f _o < 25MHz
		---	---	36			25 ≤ f _o < 50MHz
		---	---	45			50 ≤ f _o < 75MHz
		---	---	55			75 ≤ f _o < 125MHz
		---	---	60			125 ≤ f _o < 150MHz
		---	---	48			150 ≤ f _o ≤ 170MHz
		---	---	33	V _{CC} = 2.5V	10 ≤ f _o < 25MHz	
		---	---	36		25 ≤ f _o < 50MHz	
		---	---	45		50 ≤ f _o < 75MHz	
		---	---	53		75 ≤ f _o < 125MHz	
		---	---	57		125 ≤ f _o < 150MHz	
		---	---	48		150 ≤ f _o ≤ 170MHz	
		---	---	33	V _{CC} = 3.3V	10 ≤ f _o < 25MHz	
		---	---	36		25 ≤ f _o < 50MHz	
		---	---	43		50 ≤ f _o < 75MHz	
		---	---	49		75 ≤ f _o < 125MHz	
		---	---	52		125 ≤ f _o < 150MHz	
		---	---	44		150 ≤ f _o ≤ 170MHz	

Note: All electrical characteristics have defined on the maximum loaded and recommended operating conditions.

* Include initial tolerance, operating temperature range, rated power supply voltage change, load change, aging (1year @+25°C), shock and vibration

**Based on Time Interval Analyzer "Wavecrest SIA-3000".

Table 1

4-4. Measurement Condition

The reference temperature shall be +25±2°C. The measurement shall be performed at the temperature range of +5 °C to +35 °C unless otherwise the result is doubtful.

4-5. Measurement Circuit

The electrical characteristics shall be measured by test circuit "Fig. 1". Also jitter shall be measured by test circuit "Fig. 3".

4-6. Clock Timing Chart

The clock timing chart is "Fig. 2".

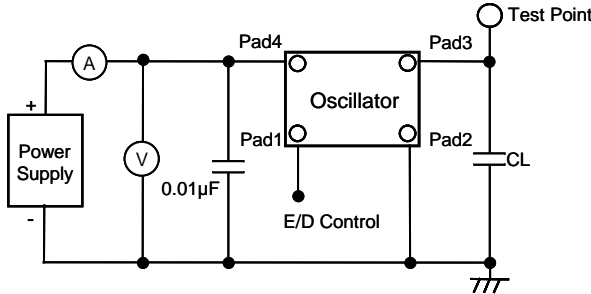

Note: CL includes probe and test fixture capacitance

Fig.1 Test Circuits

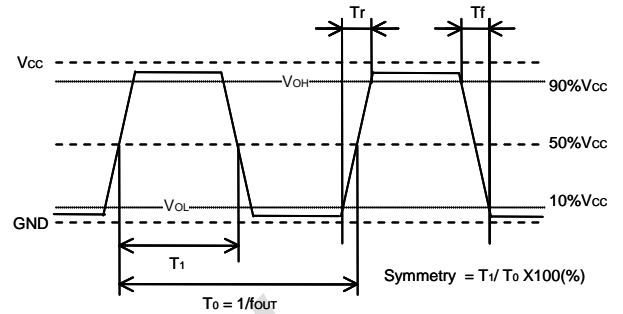
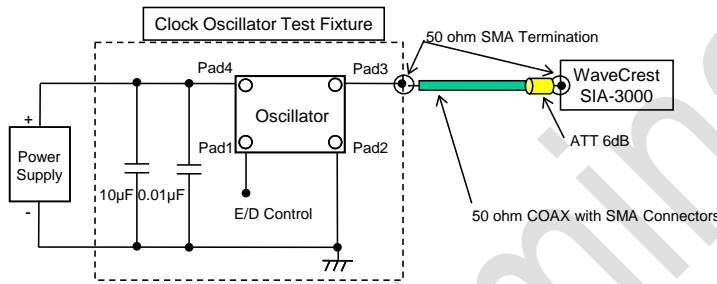

Fig.2 Clock Timing Chart (C-MOS Output)



<Measurement Conditions>

- Time Interval Analyzer
 - WaveCrest SIA-3000
- DTS timer calibration
 - Over 30 minutes warm-up
 - Extend 30 minutes calibration
- Jitter histogram conditions (Tail-fit)
 - More than 50,000cyc Hits
 - Bit Error Ratio (BER) -12 (14sigma)

Fig.3 Jitter Test Circuits

5. Dimensions and Marking

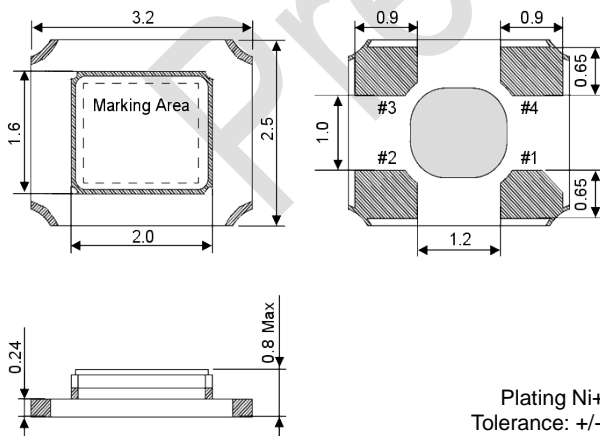

Plating Ni+Au
Tolerance: +/-0.1
Unit:(mm)

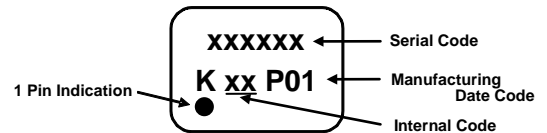

Manufacturing Date Code

- 1) Year Code (2000: "Z", 2001:"A", 2002: "B")
- 2) Weekly Code

Pad arrangement		Enable/Disable Function	
1	Enable/Disable	Pad1	Pad3 (Output)
2	Case GND	OPEN	Active
3	Output	"H" Level	Active
4	Vcc	"L" Level	High Z (No-Oscillation)

Table 2

6. Parts Numbering Guide

KC3225Z **** .****** **C 1 K X 00**
 A B C D E F G

- A. Series (SMD Oscillator)
 B. Output Frequency(MHz)
 C. Output
 C: C-MOS
 D. Supply Voltage
 1: 1.8V/ 2.5V/ 3.3V Compatible
 E. Frequency Tolerance*
 K:±20ppm

- F. Symmetry (Duty Ratio) and Enable/Disable Function
 X: Symmetry: 45% to 55% with Stand-by Function
 G. Suffix for Individual Requirements
 (STD Specification is "00")

Packing (Tape & Reel 2,000pcs/Reel)

*Over All Conditions:

Include initial tolerance, operating temperature range,
 rated power supply voltage change, load change,
 aging (1year @+25°C), shock and vibration.

Ex.

F0 < 1MHz

1MHz ≤ F0 < 10MHz

10MHz ≤ F0 < 100MHz

100MHz ≤ F0 ≤ 170MHz

Ex. 500kHz ----> KC3225Z500K000C1KX00

Ex. 8MHz ----> KC3225Z8.00000C1KX00

Ex. 50MHz ----> KC3225Z50.0000C1KX00

Ex. 125MHz ----> KC3225Z125.000C1KX00

7. Environmental Characteristics

Items	Conditions	Criteria of Acceptance
7-1. Solderability	Soaking: +245±5°C, 5.0±0.5sec	Dipped potion: Minimum 95% coverage
7-2. Soldering Heat Resistance	Reflow soldering: Peak +260°C max, 10sec, Twice max	Without looseness or crack etc.
7-3. Temperature Cycle	10 cycles: -55°C to +125°C (30minuts each/ cycle)	Clause 7-10 shall be satisfied.
7-4. Mechanical Shock (Pulse)	5 times 14,750m/sec ² (1,500G), Duration of pulse 0.5msec (MIL-STD-883D-2002.3 Condition B)	
7-5. Vibration	4 times each axis X, Y, Z: 20 to 2,000Hz and 2,000Hz to 20Hz/cycle Peak acceleration 196m/sec ² (20G) (MIL-STD-883D-2007.2 Condition A)	
7-6. High Temperature	1000 hours: Temperature: +85+5/-3°C	
7-7. Low Temperature	1000 hours: Temperature: -40+5/-3°C	
7-8. Humidity Cycle	10 cycles: Based on 1004 specifications (MIL-STD-883D-1004.7)	Clause 7-1 shall be satisfied.
7-9. Hermeticity 1 (Gross leak)	Soaking: +125°C, 5minutes	No bubbles appeared
7-10. Hermeticity 2 (Fine leak)	Measured by Helium Detector Equipment (MIL-STD-883D-1014.10 Condition A1)	5x10 ⁻⁹ Pa m ³ /sec max

After each testing, the parts shall be subjected to standard atmospheric conditions more than 2 hours. After that, the electrical characteristics shall be measured. The result of the test shall be satisfied **Table 1**.

Table 3

8. Recommended Land pattern and Soldering Guide

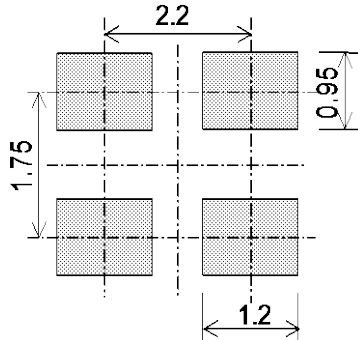

Unit: (mm)

Note:

Since the part doesn't have Bypass Capacitor between V_{cc} and GND, Please mount high frequency type capacitor $0.01\mu F$ to the nearest position of oscillator.

Fig.4 Land pattern

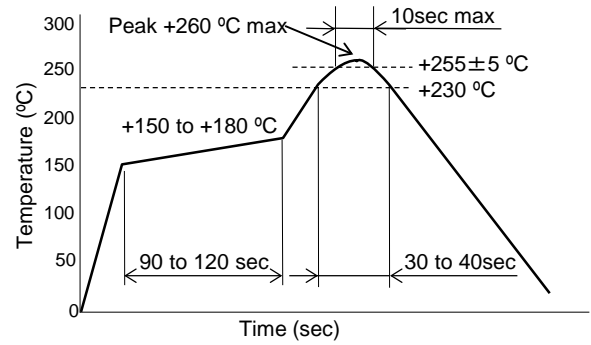

- Available Reflow times: Maximum twice

Fig.5 Reflow profile (Lead Free Available)

9. Taping Specifications

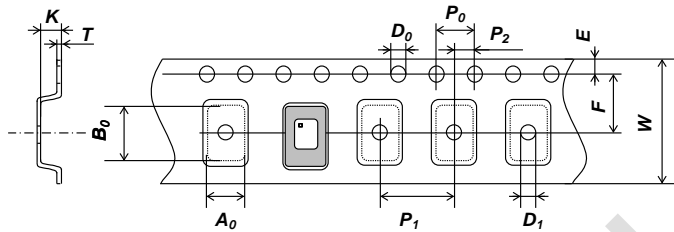

Unit: (mm)

Symbol	A₀	B₀	W	F	E
Dimensions	2.8±0.05	3.5±0.05	8.0±0.2	3.5±0.05	1.75±0.1
Symbol	P₁	P₂	P₀	D₀	T
Dimensions	4.0±0.1	2.0±0.05	4.0±0.1	1.5+0.1/-0	0.25±0.05
Symbol	K	D₁			
Dimensions	1.0±0.05	1.55±0.05			

Fig.6 Emboss Carrier Tape

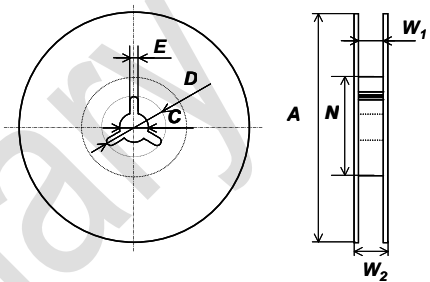

Std. Max 2,000pcs/Reel

Unit: (mm)

Symbol	A	N	W₁
Dimensions	180 +0/-1.5	60+1/-0	9.0+0.3/-0
Symbol	W₂	C	d
Dimensions	11.4±1.0	13.0±0.2	21.0±0.8
Symbol	E		
Dimensions	2.0±0.5		

Option Max 15,000pcs/Reel

Unit: (mm)

Symbol	A	N	W₁
Dimensions	330 +0/-2	100+1/-1	9.4+1/-0.5
Symbol	W₂	C	D
Dimensions	---	13.0±0.2	21.0±0.8
Symbol	E		
Dimensions	2.0±0.5		

Fig.7 Reel

9-1. Taping Quantities

- The taping of per reel shall be packed 2,000 pcs.
- The parts shall be contained continuously in the pocket.

9-2. Leader and Blank Pockets

- The package shall be consisted of leader, blank pockets and loaded pocket as follows “Fig. 8”.
- The power of peeling strength between top tape and carrier tape shall be 0.1N(10gf) to 0.7N(70gf) as follows “Fig. 9”.

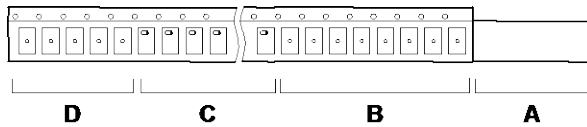

- A) Leader
 B) Blank Pocket (40mm to 320mm)
 A+B: 400mm to 560mm
 C) Load Pocket
 D) Blank Pocket (160mm minimum)

Fig.8 Packing Method

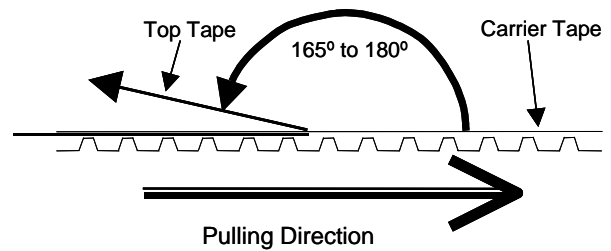

Fig.9 Peeling Strength

9-3. Reel Label

The reel label shall be consisted as below. (Based on EIAJ C-3 format)

- | | |
|-------------------------|------------------|
| A) Customer Part Number | D) Shipping Date |
| B) Lot No. | E) Vender Name |
| C) Quantities | |

9-4. Exterior Package Label

The oscillator shall be packed properly to avoid defect in transportation. The exterior package label shall be consisted as below.

- | | |
|-------------------------|------------------|
| A) Name of Customer | E) Quantities |
| B) P/O No. | F) Shipping Date |
| C) Customer Part Number | G) Vender Name |
| D) Lot No. | |

10. Production

- KYOCERA Corporation Yamagata Higashine Plant
 5850 Higashine-koh ohaza Higashine-shi Yamagata 999-3701, Japan

11. The agreement of this specifications

In case there is any obscure point or doubt concerning the contents of the specification, it shall be settled through consultation of both parties.

12. Remarks on Usages

A) Storage Conditions

The parts shall be stored in temperature range of -5 to +40°C, humidity 40 to 60% RH, and avoid direct sunlight. Then the parts shall be used within 6 months.

B) Handling Conditions

Although the part has protection circuit against static electricity, when excess static electricity is applied, the inside IC may get damaged.

Before mounting on the PCB, please make sure the direction of the part is correct. Otherwise the part of temperature will increase. And also the part will have some damages.

Please do not use the parts under the unfavorable condition such as beyond specified range in this specification.

Please do not use the parts under the condition, in the water or in the salt water also environment of dew or harmful gas.

Frequency drift may occur as a result of application of light such as direct sunlight or LED light etc when operating this oscillator.

Please use in a design and environment that consider light shielding.

Note the frequency drift will not occur if used in a light-shielded environment.

Please make sure the condition of pick and place following pick up nozzle guideline.

Picking Method: Case of Head Unit 1.6 x 1.2mm (Inside Diameter)

The proper condition of pick and place will be different each equipment. Therefore, please check before testing.

C) Rework Condition

Please do not pick up Head Unit. We can't guaranty electrical performance and reliability.

D) Soldering Conditions

This product can respond to the general Pb-free reflow profile. The wave soldering cannot be supported.

E) Soldering in Mounting

In case of Solder paste and conductive glue contact product lid or product side face exception for product terminal it's possible to influence product characteristics.

Please be careful above contents.

F) Washing Conditions

Ultra sonic cleaning is available. However there is a possibility that Crystal in the part may cause damaged under certain condition. Therefore please test before using.

After washing, please dry the parts completely. Otherwise water drops between the parts and PCB may cause migration.

In case of using this part without above precaution, Kyocera is unable to guarantee the specific characteristics.