

SN54HC365 THRU SN54HC368 SN74HC365 THRU SN74HC368 HEX BUS DRIVERS WITH 3-STATE OUTPUTS

SCLS139 D2684, DECEMBER 1982—REVISED JUNE 1989

- High-Current 3-State Outputs Drive Bus Lines, Buffer Memory Address Registers, or Up to 15 LSTTL Loads
- Choice of True or Inverting Outputs
- Package Options Include Plastic "Small Outline" Packages, Ceramic Chip Carriers, and Standard Plastic and Ceramic 300-mil DIPs
- Dependable Texas Instruments Quality and Reliability

'HC365, HC367 True Outputs
'HC366, HC368 Inverting Outputs

description

These Hex buffers and line drivers are designed specifically to improve both the performance and density of three-state memory address drivers, clock drivers, and bus-oriented receivers and transmitters. The designer has a choice of selected combinations of inverting and noninverting outputs, symmetrical G (active-low control) inputs.

The SN54HC' family is characterized for operation over the full military temperature range of -55°C to 125°C . The SN74HC' family is characterized for operation from -40°C to 85°C .

SN54HC365, SN54HC366 . . . J PACKAGE
SN74HC365, SN74HC366 . . . D[†] OR N PACKAGE

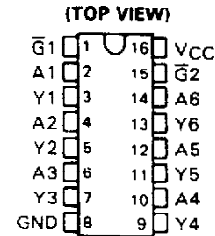

SN54HC365, SN54HC366 . . . FK PACKAGE
(TOP VIEW)

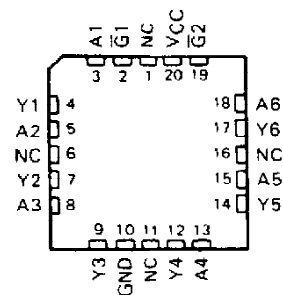

SN54HC367, SN54HC368 . . . J PACKAGE
SN74HC367, SN74HC368 . . . D[†] OR N PACKAGE

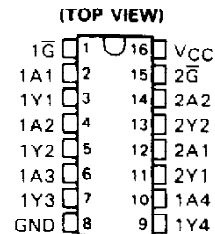

SN54HC367, SN54HC368 . . . FK PACKAGE
(TOP VIEW)

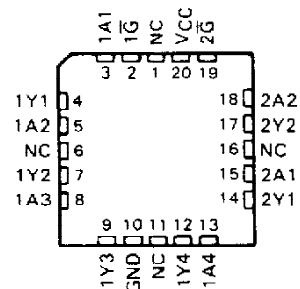

NC—No internal connection

[†] Contact the factory for D availability.

PRODUCTION DATA documents contain information current as of publication date. Products conform to specifications per the terms of Texas Instruments standard warranty. Production processing does not necessarily include testing of all parameters.

TEXAS INSTRUMENTS
POST OFFICE BOX 666012 • DALLAS, TEXAS 76265

Copyright © 1989, Texas Instruments Incorporated

**SN54HC365 THRU SN54HC368
SN74HC365 THRU SN74HC368
HEX BUS DRIVERS WITH 3-STATE OUTPUTS**

logic symbols†

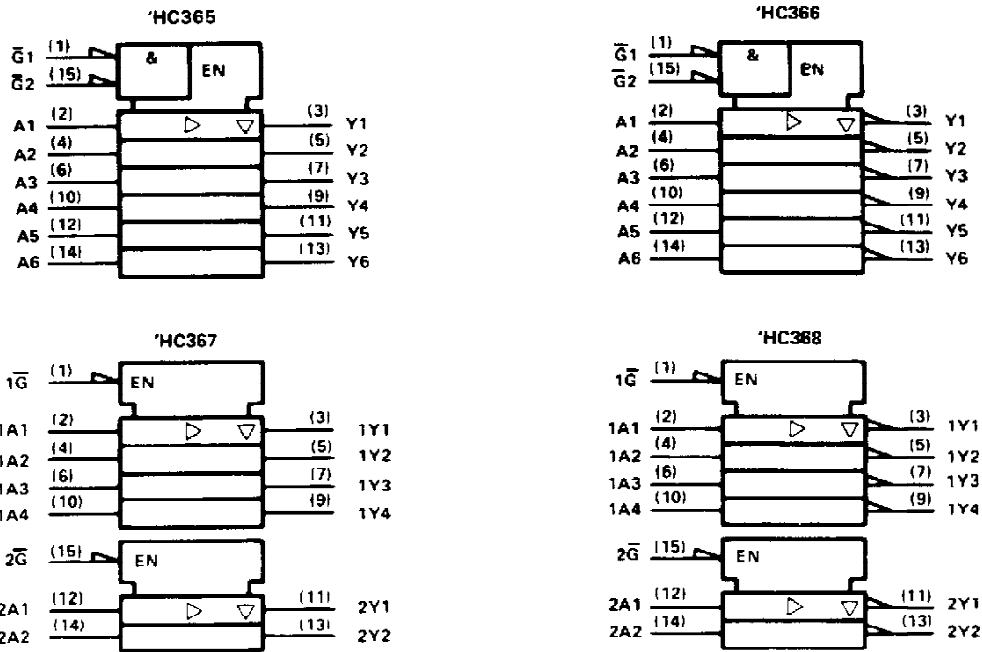

logic diagrams (positive logic)

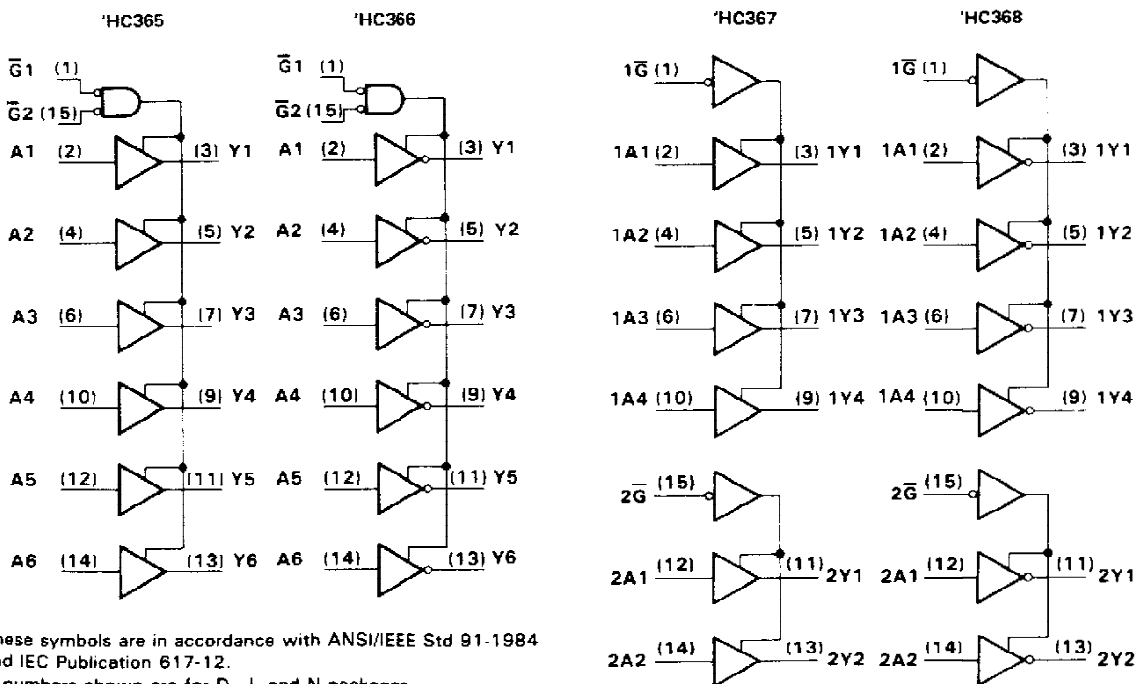

†These symbols are in accordance with ANSI/IEEE Std 91-1984 and IEC Publication 617-12. Pin numbers shown are for D, J, and N packages.

SN54HC365 THRU SN54HC368
SN74HC365 THRU SN74HC368
HEX BUS DRIVERS WITH 3-STATE OUTPUTS

absolute maximum ratings over operating free-air temperature range†

Supply voltage, V_{CC}	-0.5 V to 7 V
Input clamp current, I_{IK} ($V_I < 0$ or $V_I > V_{CC}$)	± 20 mA
Output clamp current, I_{OK} ($V_O < 0$ or $V_O > V_{CC}$)	± 20 mA
Continuous output current, I_O ($V_O = 0$ to V_{CC})	± 35 mA
Continuous current through V_{CC} or GND pins	± 70 mA
Lead temperature 1,6 mm (1/16 in) from case for 60 s: FK or J package	300°C
Lead temperature 1,6 mm (1/16 in) from case for 10 s: D or N package	260°C
Storage temperature range	-65°C to 150°C

†Stresses beyond those listed under "absolute maximum ratings" may cause permanent damage to the device. These are stress ratings only, and functional operation of the device at these or any other conditions beyond those indicated under "recommended operating conditions" is not implied. Exposure to absolute-maximum-rated conditions for extended periods may affect device reliability.

recommended operating conditions

		SN54HC365 thru SN54HC368			SN74HC365 thru SN74HC368			UNIT
		MIN	NOM	MAX	MIN	NOM	MAX	
V_{CC}	Supply voltage	2	5	6	2	5	6	V
V_{IH}	High-level input voltage	$V_{CC} = 2$ V		1.5	$V_{CC} = 2$ V		1.5	V
		$V_{CC} = 4.5$ V		3.15	$V_{CC} = 4.5$ V		3.15	
		$V_{CC} = 6$ V		4.2	$V_{CC} = 6$ V		4.2	
V_{IL}	Low-level input voltage	$V_{CC} = 2$ V		0	$V_{CC} = 2$ V		0	V
		$V_{CC} = 4.5$ V		0	$V_{CC} = 4.5$ V		0	
		$V_{CC} = 6$ V		0	$V_{CC} = 6$ V		0	
V_I	Input voltage	0	V_{CC}		0	V_{CC}		V
V_O	Output voltage	0	V_{CC}		0	V_{CC}		V
t_t	Input transition (rise and fall) times	$V_{CC} = 2$ V		0	$V_{CC} = 2$ V		0	ns
		$V_{CC} = 4.5$ V		0	$V_{CC} = 4.5$ V		0	
		$V_{CC} = 6$ V		0	$V_{CC} = 6$ V		0	
T_A	Operating free-air temperature	-55	125		-40	85		°C

**SN54HC365 THRU SN54HC368
SN74HC365 THRU SN74HC368
HEX BUS DRIVERS WITH 3-STATE OUTPUTS**

electrical characteristics over recommended operating free-air temperature range (unless otherwise noted)

PARAMETER	TEST CONDITIONS	V _{CC}	T _A = 25°C			SN54HC365 thru SN54HC368		SN74HC365 thru SN74HC368		UNIT
			MIN	TYP	MAX	MIN	MAX	MIN	MAX	
V _{OH}	V _I = V _{IH} or V _{IL} , I _{OH} = -20 μA	2 V	1.9	1.998		1.9		1.9	V	
		4.5 V	4.4	4.499		4.4		4.4		
		6 V	5.9	5.999		5.9		5.9		
	V _I = V _{IH} or V _{IL} , I _{OH} = -6 mA	4.5 V	3.98	4.30		3.7		3.84		
	V _I = V _{IH} or V _{IL} , I _{OH} = -7.8 mA	6 V	5.48	5.80		5.2		5.34		
V _{OL}	V _I = V _{IH} or V _{IL} , I _{OL} = 20 μA	2 V		0.002	0.1		0.1		0.1	V
		4.5 V		0.001	0.1		0.1		0.1	
		6 V		0.001	0.1		0.1		0.1	
	V _I = V _{IH} or V _{IL} , I _{OL} = 6 mA	4.5 V		0.17	0.26		0.4		0.33	
	V _I = V _{IH} or V _{IL} , I _{OL} = 7.8 mA	6 V		0.15	0.26		0.4		0.33	
I _I	V _I = V _{CC} or 0	6 V	±0.1	±100		±1000		±1000	nA	
I _{OZ}	V _O = V _{CC} or 0	6	±0.01	±0.5		±10		±5	μA	
I _{CC}	V _I = V _{CC} or 0, I _O = 0	6 V				8		160	μA	
C _i		2 to 6 V		3	10		10		10	pF

**SN54HC365 THRU SN54HC368
SN74HC365 THRU SN74HC368
HEX BUS DRIVERS WITH 3-STATE OUTPUTS**

switching characteristics over recommended operating free-air temperature range (unless otherwise noted), $C_L = 50$ pF (see Note 1)

PARAMETER	FROM (INPUT)	TO (OUTPUT)	V _{CC}	T _A = 25°C			SN54HC'		SN74HC'		UNIT
				MIN	TYP	MAX	MIN	MAX	MIN	MAX	
t _{pd}	A	Y	2 V		50	95		145		120	ns
			4.5 V		12	19		29		24	
			6 V		10	16		25		20	
t _{en}	\bar{G}	Y	2 V		100	190		285		238	ns
			4.5 V		26	38		57		48	
			6 V		21	32		48		41	
t _{dis}	\bar{G}	Y	2 V		50	175		265		240	ns
			4.5 V		21	35		53		48	
			6 V		19	30		45		41	
t _t		Any	2 V		28	60		90		75	ns
			4.5 V		8	12		18		15	
			6 V		6	10		15		13	

C _{pd}	Power dissipation capacitance per driver	No load, T _A = 25°C	35 pF typ
-----------------	--	--------------------------------	-----------

switching characteristics over recommended operating free-air temperature range (unless otherwise noted), $C_L = 150$ pF (see Note 1)

PARAMETER	FROM (INPUT)	TO (OUTPUT)	V _{CC}	T _A = 25°C			SN54HC'		SN74HC'		UNIT
				MIN	TYP	MAX	MIN	MAX	MIN	MAX	
t _{pd}	A	Y	2 V		70	120		180		150	ns
			4.5 V		17	24		36		30	
			6 V		14	20		31		25	
t _{en}	\bar{G}	Y	2 V		140	230		345		285	ns
			4.5 V		30	46		69		57	
			6 V		28	39		59		48	
t _t			2 V		45	210		315		265	ns
			4.5 V		17	42		63		53	
			6 V		13	36		53		45	

NOTE 1: Load circuit and voltage waveforms are shown in Section 1.

PACKAGING INFORMATION

Orderable Device	Status (1)	Package Type	Package Drawing	Pins	Package Qty	Eco Plan (2)	Lead finish/ Ball material (6)	MSL Peak Temp (3)	Op Temp (°C)	Device Marking (4/5)	Samples
5962-86812012A	ACTIVE	LCCC	FK	20	1	Non-RoHS & Green	SNPB	N / A for Pkg Type	-55 to 125	5962-86812012A SNJ54HC 368FK	Samples
5962-8681201EA	ACTIVE	CDIP	J	16	1	Non-RoHS & Green	SNPB	N / A for Pkg Type	-55 to 125	5962-8681201EA SNJ54HC368J	Samples
5962-8681201EA	ACTIVE	CDIP	J	16	1	Non-RoHS & Green	SNPB	N / A for Pkg Type	-55 to 125	5962-8681201EA SNJ54HC368J	Samples
5962-8682801EA	ACTIVE	CDIP	J	16	1	Non-RoHS & Green	SNPB	N / A for Pkg Type	-55 to 125	5962-8682801EA SNJ54HC366J	Samples
5962-8682801EA	ACTIVE	CDIP	J	16	1	Non-RoHS & Green	SNPB	N / A for Pkg Type	-55 to 125	5962-8682801EA SNJ54HC366J	Samples
8500101EA	ACTIVE	CDIP	J	16	1	Non-RoHS & Green	SNPB	N / A for Pkg Type	-55 to 125	8500101EA SNJ54HC365J	Samples
8500101EA	ACTIVE	CDIP	J	16	1	Non-RoHS & Green	SNPB	N / A for Pkg Type	-55 to 125	8500101EA SNJ54HC365J	Samples
8500201EA	ACTIVE	CDIP	J	16	1	Non-RoHS & Green	SNPB	N / A for Pkg Type	-55 to 125	8500201EA SNJ54HC367J	Samples
8500201EA	ACTIVE	CDIP	J	16	1	Non-RoHS & Green	SNPB	N / A for Pkg Type	-55 to 125	8500201EA SNJ54HC367J	Samples
JM38510/65706BEA	ACTIVE	CDIP	J	16	1	Non-RoHS & Green	SNPB	N / A for Pkg Type	-55 to 125	JM38510/ 65706BEA	Samples
JM38510/65706BEA	ACTIVE	CDIP	J	16	1	Non-RoHS & Green	SNPB	N / A for Pkg Type	-55 to 125	JM38510/ 65706BEA	Samples
JM38510/65708BEA	ACTIVE	CDIP	J	16	1	Non-RoHS & Green	SNPB	N / A for Pkg Type	-55 to 125	JM38510/ 65708BEA	Samples
JM38510/65708BEA	ACTIVE	CDIP	J	16	1	Non-RoHS & Green	SNPB	N / A for Pkg Type	-55 to 125	JM38510/ 65708BEA	Samples
JM38510/65709BEA	ACTIVE	CDIP	J	16	1	Non-RoHS & Green	SNPB	N / A for Pkg Type	-55 to 125	JM38510/ 65709BEA	Samples
JM38510/65709BEA	ACTIVE	CDIP	J	16	1	Non-RoHS & Green	SNPB	N / A for Pkg Type	-55 to 125	JM38510/ 65709BEA	Samples
M38510/65706BEA	ACTIVE	CDIP	J	16	1	Non-RoHS & Green	SNPB	N / A for Pkg Type	-55 to 125	JM38510/ 65706BEA	Samples

Orderable Device	Status (1)	Package Type	Package Drawing	Pins	Package Qty	Eco Plan (2)	Lead finish/ Ball material (6)	MSL Peak Temp (3)	Op Temp (°C)	Device Marking (4/5)	Samples
M38510/65706BEA	ACTIVE	CDIP	J	16	1	Non-RoHS & Green	SNPB	N / A for Pkg Type	-55 to 125	JM38510/ 65706BEA	Samples
M38510/65708BEA	ACTIVE	CDIP	J	16	1	Non-RoHS & Green	SNPB	N / A for Pkg Type	-55 to 125	JM38510/ 65708BEA	Samples
M38510/65708BEA	ACTIVE	CDIP	J	16	1	Non-RoHS & Green	SNPB	N / A for Pkg Type	-55 to 125	JM38510/ 65708BEA	Samples
M38510/65709BEA	ACTIVE	CDIP	J	16	1	Non-RoHS & Green	SNPB	N / A for Pkg Type	-55 to 125	JM38510/ 65709BEA	Samples
M38510/65709BEA	ACTIVE	CDIP	J	16	1	Non-RoHS & Green	SNPB	N / A for Pkg Type	-55 to 125	JM38510/ 65709BEA	Samples
SN54HC365J	ACTIVE	CDIP	J	16	1	Non-RoHS & Green	SNPB	N / A for Pkg Type	-55 to 125	SN54HC365J	Samples
SN54HC365J	ACTIVE	CDIP	J	16	1	Non-RoHS & Green	SNPB	N / A for Pkg Type	-55 to 125	SN54HC365J	Samples
SN54HC366J	ACTIVE	CDIP	J	16	1	Non-RoHS & Green	SNPB	N / A for Pkg Type	-55 to 125	SN54HC366J	Samples
SN54HC366J	ACTIVE	CDIP	J	16	1	Non-RoHS & Green	SNPB	N / A for Pkg Type	-55 to 125	SN54HC366J	Samples
SN54HC367J	ACTIVE	CDIP	J	16	1	Non-RoHS & Green	SNPB	N / A for Pkg Type	-55 to 125	SN54HC367J	Samples
SN54HC367J	ACTIVE	CDIP	J	16	1	Non-RoHS & Green	SNPB	N / A for Pkg Type	-55 to 125	SN54HC367J	Samples
SN54HC368J	ACTIVE	CDIP	J	16	1	Non-RoHS & Green	SNPB	N / A for Pkg Type	-55 to 125	SN54HC368J	Samples
SN54HC368J	ACTIVE	CDIP	J	16	1	Non-RoHS & Green	SNPB	N / A for Pkg Type	-55 to 125	SN54HC368J	Samples
SN74HC365DR	ACTIVE	SOIC	D	16	2500	RoHS & Green	NIPDAU SN	Level-1-260C-UNLIM	-40 to 85	HC365	Samples
SN74HC365DR	ACTIVE	SOIC	D	16	2500	RoHS & Green	NIPDAU SN	Level-1-260C-UNLIM	-40 to 85	HC365	Samples
SN74HC365N	ACTIVE	PDIP	N	16	25	RoHS & Green	NIPDAU	N / A for Pkg Type	-40 to 85	SN74HC365N	Samples
SN74HC365N	ACTIVE	PDIP	N	16	25	RoHS & Green	NIPDAU	N / A for Pkg Type	-40 to 85	SN74HC365N	Samples
SN74HC365NSR	ACTIVE	SO	NS	16	2000	RoHS & Green	NIPDAU	Level-1-260C-UNLIM	-40 to 85	HC365	Samples

Orderable Device	Status (1)	Package Type	Package Drawing	Pins	Package Qty	Eco Plan (2)	Lead finish/ Ball material (6)	MSL Peak Temp (3)	Op Temp (°C)	Device Marking (4/5)	Samples
SN74HC365NSR	ACTIVE	SO	NS	16	2000	RoHS & Green	NIPDAU	Level-1-260C-UNLIM	-40 to 85	HC365	Samples
SN74HC365PWR	ACTIVE	TSSOP	PW	16	2000	RoHS & Green	NIPDAU SN	Level-1-260C-UNLIM	-40 to 85	HC365	Samples
SN74HC365PWR	ACTIVE	TSSOP	PW	16	2000	RoHS & Green	NIPDAU SN	Level-1-260C-UNLIM	-40 to 85	HC365	Samples
SN74HC367DR	ACTIVE	SOIC	D	16	2500	RoHS & Green	NIPDAU SN	Level-1-260C-UNLIM	-40 to 85	HC367	Samples
SN74HC367DR	ACTIVE	SOIC	D	16	2500	RoHS & Green	NIPDAU SN	Level-1-260C-UNLIM	-40 to 85	HC367	Samples
SN74HC367N	ACTIVE	PDIP	N	16	25	RoHS & Green	NIPDAU	N / A for Pkg Type	-40 to 85	SN74HC367N	Samples
SN74HC367N	ACTIVE	PDIP	N	16	25	RoHS & Green	NIPDAU	N / A for Pkg Type	-40 to 85	SN74HC367N	Samples
SN74HC367NSR	ACTIVE	SO	NS	16	2000	RoHS & Green	NIPDAU	Level-1-260C-UNLIM	-40 to 85	HC367	Samples
SN74HC367NSR	ACTIVE	SO	NS	16	2000	RoHS & Green	NIPDAU	Level-1-260C-UNLIM	-40 to 85	HC367	Samples
SN74HC367PWR	ACTIVE	TSSOP	PW	16	2000	RoHS & Green	NIPDAU SN	Level-1-260C-UNLIM	-40 to 85	HC367	Samples
SN74HC367PWR	ACTIVE	TSSOP	PW	16	2000	RoHS & Green	NIPDAU SN	Level-1-260C-UNLIM	-40 to 85	HC367	Samples
SN74HC368DR	ACTIVE	SOIC	D	16	2500	RoHS & Green	NIPDAU SN	Level-1-260C-UNLIM	-40 to 85	HC368	Samples
SN74HC368DR	ACTIVE	SOIC	D	16	2500	RoHS & Green	NIPDAU SN	Level-1-260C-UNLIM	-40 to 85	HC368	Samples
SN74HC368N	ACTIVE	PDIP	N	16	25	RoHS & Green	NIPDAU	N / A for Pkg Type	-40 to 85	SN74HC368N	Samples
SN74HC368N	ACTIVE	PDIP	N	16	25	RoHS & Green	NIPDAU	N / A for Pkg Type	-40 to 85	SN74HC368N	Samples
SN74HC368NE4	ACTIVE	PDIP	N	16	25	RoHS & Green	NIPDAU	N / A for Pkg Type	-40 to 85	SN74HC368N	Samples
SN74HC368NE4	ACTIVE	PDIP	N	16	25	RoHS & Green	NIPDAU	N / A for Pkg Type	-40 to 85	SN74HC368N	Samples
SN74HC368NSR	ACTIVE	SO	NS	16	2000	RoHS & Green	NIPDAU	Level-1-260C-UNLIM	-40 to 85	HC368	Samples
SN74HC368NSR	ACTIVE	SO	NS	16	2000	RoHS & Green	NIPDAU	Level-1-260C-UNLIM	-40 to 85	HC368	Samples
SN74HC368PWR	ACTIVE	TSSOP	PW	16	2000	RoHS & Green	NIPDAU	Level-1-260C-UNLIM	-40 to 85	HC368	Samples
SN74HC368PWR	ACTIVE	TSSOP	PW	16	2000	RoHS & Green	NIPDAU	Level-1-260C-UNLIM	-40 to 85	HC368	Samples

Orderable Device	Status (1)	Package Type	Package Drawing	Pins	Package Qty	Eco Plan (2)	Lead finish/ Ball material (6)	MSL Peak Temp (3)	Op Temp (°C)	Device Marking (4/5)	Samples
SNJ54HC365J	ACTIVE	CDIP	J	16	1	Non-RoHS & Green	SNPB	N / A for Pkg Type	-55 to 125	8500101EA SNJ54HC365J	Samples
SNJ54HC365J	ACTIVE	CDIP	J	16	1	Non-RoHS & Green	SNPB	N / A for Pkg Type	-55 to 125	8500101EA SNJ54HC365J	Samples
SNJ54HC366J	ACTIVE	CDIP	J	16	1	Non-RoHS & Green	SNPB	N / A for Pkg Type	-55 to 125	5962-8682801EA SNJ54HC366J	Samples
SNJ54HC366J	ACTIVE	CDIP	J	16	1	Non-RoHS & Green	SNPB	N / A for Pkg Type	-55 to 125	5962-8682801EA SNJ54HC366J	Samples
SNJ54HC367J	ACTIVE	CDIP	J	16	1	Non-RoHS & Green	SNPB	N / A for Pkg Type	-55 to 125	8500201EA SNJ54HC367J	Samples
SNJ54HC367J	ACTIVE	CDIP	J	16	1	Non-RoHS & Green	SNPB	N / A for Pkg Type	-55 to 125	8500201EA SNJ54HC367J	Samples
SNJ54HC368FK	ACTIVE	LCCC	FK	20	1	Non-RoHS & Green	SNPB	N / A for Pkg Type	-55 to 125	5962- 86812012A SNJ54HC 368FK	Samples
SNJ54HC368FK	ACTIVE	LCCC	FK	20	1	Non-RoHS & Green	SNPB	N / A for Pkg Type	-55 to 125	5962- 86812012A SNJ54HC 368FK	Samples
SNJ54HC368J	ACTIVE	CDIP	J	16	1	Non-RoHS & Green	SNPB	N / A for Pkg Type	-55 to 125	5962-8681201EA SNJ54HC368J	Samples
SNJ54HC368J	ACTIVE	CDIP	J	16	1	Non-RoHS & Green	SNPB	N / A for Pkg Type	-55 to 125	5962-8681201EA SNJ54HC368J	Samples

(1) The marketing status values are defined as follows:

ACTIVE: Product device recommended for new designs.

LIFEBUY: TI has announced that the device will be discontinued, and a lifetime-buy period is in effect.

NRND: Not recommended for new designs. Device is in production to support existing customers, but TI does not recommend using this part in a new design.

PREVIEW: Device has been announced but is not in production. Samples may or may not be available.

OBSELETE: TI has discontinued the production of the device.

(2) **RoHS:** TI defines "RoHS" to mean semiconductor products that are compliant with the current EU RoHS requirements for all 10 RoHS substances, including the requirement that RoHS substance do not exceed 0.1% by weight in homogeneous materials. Where designed to be soldered at high temperatures, "RoHS" products are suitable for use in specified lead-free processes. TI may reference these types of products as "Pb-Free".

RoHS Exempt: TI defines "RoHS Exempt" to mean products that contain lead but are compliant with EU RoHS pursuant to a specific EU RoHS exemption.

Green: TI defines "Green" to mean the content of Chlorine (Cl) and Bromine (Br) based flame retardants meet JS709B low halogen requirements of <=1000ppm threshold. Antimony trioxide based flame retardants must also meet the <=1000ppm threshold requirement.

(3) MSL, Peak Temp. - The Moisture Sensitivity Level rating according to the JEDEC industry standard classifications, and peak solder temperature.

(4) There may be additional marking, which relates to the logo, the lot trace code information, or the environmental category on the device.

(5) Multiple Device Markings will be inside parentheses. Only one Device Marking contained in parentheses and separated by a "~" will appear on a device. If a line is indented then it is a continuation of the previous line and the two combined represent the entire Device Marking for that device.

(6) Lead finish/Ball material - Orderable Devices may have multiple material finish options. Finish options are separated by a vertical ruled line. Lead finish/Ball material values may wrap to two lines if the finish value exceeds the maximum column width.

Important Information and Disclaimer:The information provided on this page represents TI's knowledge and belief as of the date that it is provided. TI bases its knowledge and belief on information provided by third parties, and makes no representation or warranty as to the accuracy of such information. Efforts are underway to better integrate information from third parties. TI has taken and continues to take reasonable steps to provide representative and accurate information but may not have conducted destructive testing or chemical analysis on incoming materials and chemicals. TI and TI suppliers consider certain information to be proprietary, and thus CAS numbers and other limited information may not be available for release.

In no event shall TI's liability arising out of such information exceed the total purchase price of the TI part(s) at issue in this document sold by TI to Customer on an annual basis.

OTHER QUALIFIED VERSIONS OF SN54HC365, SN54HC367, SN54HC368, SN74HC365, SN74HC367, SN74HC368 :

● Catalog : [SN74HC365](#), [SN74HC367](#), [SN74HC368](#)

● Military : [SN54HC365](#), [SN54HC367](#), [SN54HC368](#)

NOTE: Qualified Version Definitions:

- Catalog - TI's standard catalog product
- Military - QML certified for Military and Defense Applications

TAPE AND REEL INFORMATION

QUADRANT ASSIGNMENTS FOR PIN 1 ORIENTATION IN TAPE

*All dimensions are nominal

Device	Package Type	Package Drawing	Pins	SPQ	Reel Diameter (mm)	Reel Width W1 (mm)	A0 (mm)	B0 (mm)	K0 (mm)	P1 (mm)	W (mm)	Pin1 Quadrant
SN74HC365DR	SOIC	D	16	2500	330.0	16.4	6.5	10.3	2.1	8.0	16.0	Q1
SN74HC365DR	SOIC	D	16	2500	330.0	16.4	6.5	10.3	2.1	8.0	16.0	Q1
SN74HC365DR	SOIC	D	16	2500	330.0	16.4	6.6	9.3	2.1	8.0	16.0	Q1
SN74HC365NSR	SO	NS	16	2000	330.0	16.4	8.45	10.55	2.5	12.0	16.2	Q1
SN74HC365NSR	SO	NS	16	2000	330.0	16.4	8.2	10.5	2.5	12.0	16.0	Q1
SN74HC365PWR	TSSOP	PW	16	2000	330.0	12.4	6.9	5.6	1.6	8.0	12.0	Q1
SN74HC365PWR	TSSOP	PW	16	2000	330.0	12.4	6.9	5.6	1.6	8.0	12.0	Q1
SN74HC365PWR	TSSOP	PW	16	2000	330.0	12.4	6.85	5.45	1.6	8.0	12.0	Q1
SN74HC367DR	SOIC	D	16	2500	330.0	16.4	6.6	9.3	2.1	8.0	16.0	Q1
SN74HC367DR	SOIC	D	16	2500	330.0	16.4	6.5	10.3	2.1	8.0	16.0	Q1
SN74HC367NSR	SO	NS	16	2000	330.0	16.4	8.45	10.55	2.5	12.0	16.2	Q1
SN74HC367NSR	SO	NS	16	2000	330.0	16.4	8.2	10.5	2.5	12.0	16.0	Q1
SN74HC367PWR	TSSOP	PW	16	2000	330.0	12.4	6.9	5.6	1.6	8.0	12.0	Q1
SN74HC367PWR	TSSOP	PW	16	2000	330.0	12.4	6.9	5.6	1.6	8.0	12.0	Q1
SN74HC367PWR	TSSOP	PW	16	2000	330.0	12.4	6.85	5.45	1.6	8.0	12.0	Q1
SN74HC368DR	SOIC	D	16	2500	330.0	16.4	6.6	9.3	2.1	8.0	16.0	Q1

Device	Package Type	Package Drawing	Pins	SPQ	Reel Diameter (mm)	Reel Width W1 (mm)	A0 (mm)	B0 (mm)	K0 (mm)	P1 (mm)	W (mm)	Pin1 Quadrant
SN74HC368DR	SOIC	D	16	2500	330.0	16.4	6.5	10.3	2.1	8.0	16.0	Q1
SN74HC368DR	SOIC	D	16	2500	330.0	16.4	6.5	10.3	2.1	8.0	16.0	Q1
SN74HC368NSR	SO	NS	16	2000	330.0	16.4	8.2	10.5	2.5	12.0	16.0	Q1
SN74HC368PWR	TSSOP	PW	16	2000	330.0	12.4	6.9	5.6	1.6	8.0	12.0	Q1
SN74HC368PWR	TSSOP	PW	16	2000	330.0	12.4	6.9	5.6	1.6	8.0	12.0	Q1

TAPE AND REEL BOX DIMENSIONS



*All dimensions are nominal

Device	Package Type	Package Drawing	Pins	SPQ	Length (mm)	Width (mm)	Height (mm)
SN74HC365DR	SOIC	D	16	2500	340.5	336.1	32.0
SN74HC365DR	SOIC	D	16	2500	356.0	356.0	35.0
SN74HC365DR	SOIC	D	16	2500	366.0	364.0	50.0
SN74HC365NSR	SO	NS	16	2000	356.0	356.0	35.0
SN74HC365NSR	SO	NS	16	2000	356.0	356.0	35.0
SN74HC365PWR	TSSOP	PW	16	2000	356.0	356.0	35.0
SN74HC365PWR	TSSOP	PW	16	2000	356.0	356.0	35.0
SN74HC365PWR	TSSOP	PW	16	2000	366.0	364.0	50.0
SN74HC367DR	SOIC	D	16	2500	366.0	364.0	50.0
SN74HC367DR	SOIC	D	16	2500	356.0	356.0	35.0
SN74HC367NSR	SO	NS	16	2000	356.0	356.0	35.0
SN74HC367NSR	SO	NS	16	2000	356.0	356.0	35.0
SN74HC367PWR	TSSOP	PW	16	2000	356.0	356.0	35.0
SN74HC367PWR	TSSOP	PW	16	2000	356.0	356.0	35.0
SN74HC367PWR	TSSOP	PW	16	2000	366.0	364.0	50.0
SN74HC368DR	SOIC	D	16	2500	366.0	364.0	50.0
SN74HC368DR	SOIC	D	16	2500	356.0	356.0	35.0
SN74HC368DR	SOIC	D	16	2500	340.5	336.1	32.0

Device	Package Type	Package Drawing	Pins	SPQ	Length (mm)	Width (mm)	Height (mm)
SN74HC368NSR	SO	NS	16	2000	356.0	356.0	35.0
SN74HC368PWR	TSSOP	PW	16	2000	356.0	356.0	35.0
SN74HC368PWR	TSSOP	PW	16	2000	356.0	356.0	35.0

TUBE

*All dimensions are nominal

Device	Package Name	Package Type	Pins	SPQ	L (mm)	W (mm)	T (μm)	B (mm)
5962-86812012A	FK	LCCC	20	1	506.98	12.06	2030	NA
SN74HC365N	N	PDIP	16	25	506	13.97	11230	4.32
SN74HC365N	N	PDIP	16	25	506	13.97	11230	4.32
SN74HC367N	N	PDIP	16	25	506	13.97	11230	4.32
SN74HC367N	N	PDIP	16	25	506	13.97	11230	4.32
SN74HC368N	N	PDIP	16	25	506	13.97	11230	4.32
SN74HC368N	N	PDIP	16	25	506	13.97	11230	4.32
SN74HC368NE4	N	PDIP	16	25	506	13.97	11230	4.32
SN74HC368NE4	N	PDIP	16	25	506	13.97	11230	4.32
SNJ54HC368FK	FK	LCCC	20	1	506.98	12.06	2030	NA

EXAMPLE BOARD LAYOUT

NS0016A

SOP - 2.00 mm max height

SOP

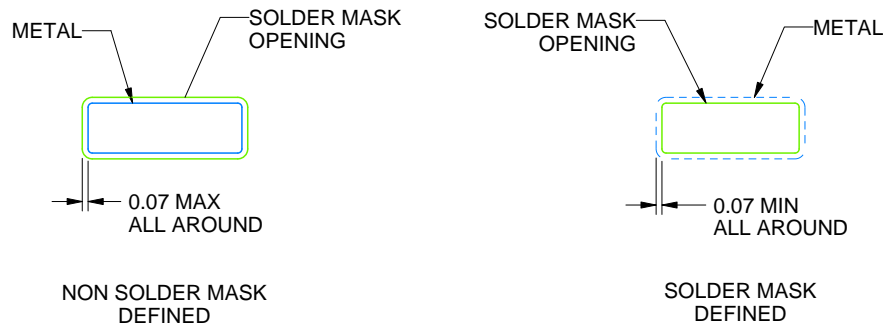

4220735/A 12/2021

NOTES: (continued)

5. Publication IPC-7351 may have alternate designs.

6. Solder mask tolerances between and around signal pads can vary based on board fabrication site.

EXAMPLE STENCIL DESIGN

NS0016A

SOP - 2.00 mm max height

SOP

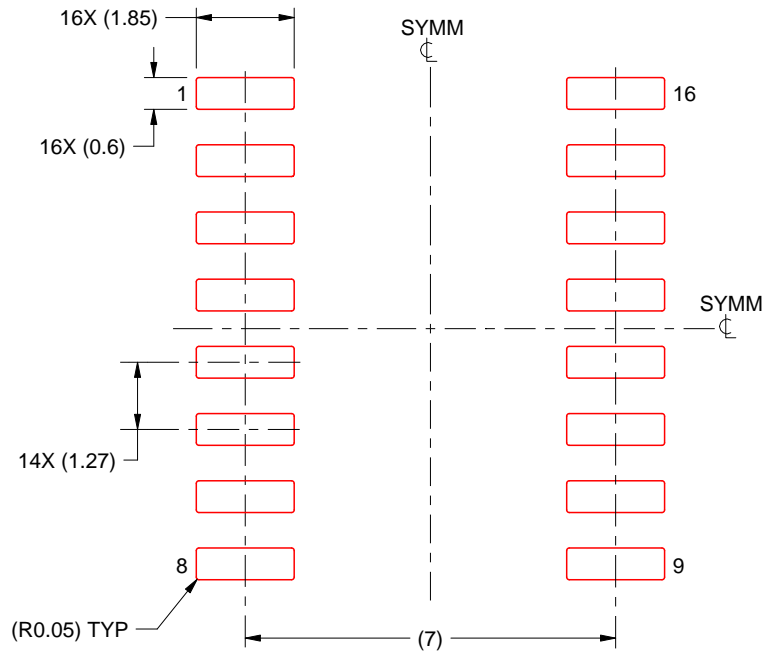

SOLDER PASTE EXAMPLE
BASED ON 0.125 mm THICK STENCIL
SCALE:7X

4220735/A 12/2021

NOTES: (continued)

7. Laser cutting apertures with trapezoidal walls and rounded corners may offer better paste release. IPC-7525 may have alternate design recommendations.
8. Board assembly site may have different recommendations for stencil design.

D (R-PDSO-G16)

PLASTIC SMALL OUTLINE



- NOTES:
- A. All linear dimensions are in inches (millimeters).
 - B. This drawing is subject to change without notice.
 - C. Body length does not include mold flash, protrusions, or gate burrs. Mold flash, protrusions, or gate burrs shall not exceed 0.006 (0,15) each side.
 - D. Body width does not include interlead flash. Interlead flash shall not exceed 0.017 (0,43) each side.
 - E. Reference JEDEC MS-012 variation AC.

D (R-PDSO-G16)

PLASTIC SMALL OUTLINE



- NOTES:
- All linear dimensions are in millimeters.
 - This drawing is subject to change without notice.
 - Publication IPC-7351 is recommended for alternate designs.
 - Laser cutting apertures with trapezoidal walls and also rounding corners will offer better paste release. Customers should contact their board assembly site for stencil design recommendations. Refer to IPC-7525 for other stencil recommendations.
 - Customers should contact their board fabrication site for solder mask tolerances between and around signal pads.



4220204/A 02/2017

NOTES:

1. All linear dimensions are in millimeters. Any dimensions in parenthesis are for reference only. Dimensioning and tolerancing per ASME Y14.5M.
2. This drawing is subject to change without notice.
3. This dimension does not include mold flash, protrusions, or gate burrs. Mold flash, protrusions, or gate burrs shall not exceed 0.15 mm per side.
4. This dimension does not include interlead flash. Interlead flash shall not exceed 0.25 mm per side.
5. Reference JEDEC registration MO-153.

EXAMPLE BOARD LAYOUT

PW0016A

TSSOP - 1.2 mm max height

SMALL OUTLINE PACKAGE



LAND PATTERN EXAMPLE
EXPOSED METAL SHOWN
SCALE: 10X



SOLDER MASK DETAILS

4220204/A 02/2017

NOTES: (continued)

- 6. Publication IPC-7351 may have alternate designs.
- 7. Solder mask tolerances between and around signal pads can vary based on board fabrication site.

EXAMPLE STENCIL DESIGN

PW0016A

TSSOP - 1.2 mm max height

SMALL OUTLINE PACKAGE



SOLDER PASTE EXAMPLE
BASED ON 0.125 mm THICK STENCIL
SCALE: 10X

4220204/A 02/2017

NOTES: (continued)

8. Laser cutting apertures with trapezoidal walls and rounded corners may offer better paste release. IPC-7525 may have alternate design recommendations.
9. Board assembly site may have different recommendations for stencil design.

MECHANICAL DATA

NS (R-PDSO-G**)

PLASTIC SMALL-OUTLINE PACKAGE

14-PINS SHOWN



- NOTES:
- A. All linear dimensions are in millimeters.
 - B. This drawing is subject to change without notice.
 - C. Body dimensions do not include mold flash or protrusion, not to exceed 0,15.

GENERIC PACKAGE VIEW

FK 20

LCCC - 2.03 mm max height

8.89 x 8.89, 1.27 mm pitch

LEADLESS CERAMIC CHIP CARRIER

This image is a representation of the package family, actual package may vary.
Refer to the product data sheet for package details.

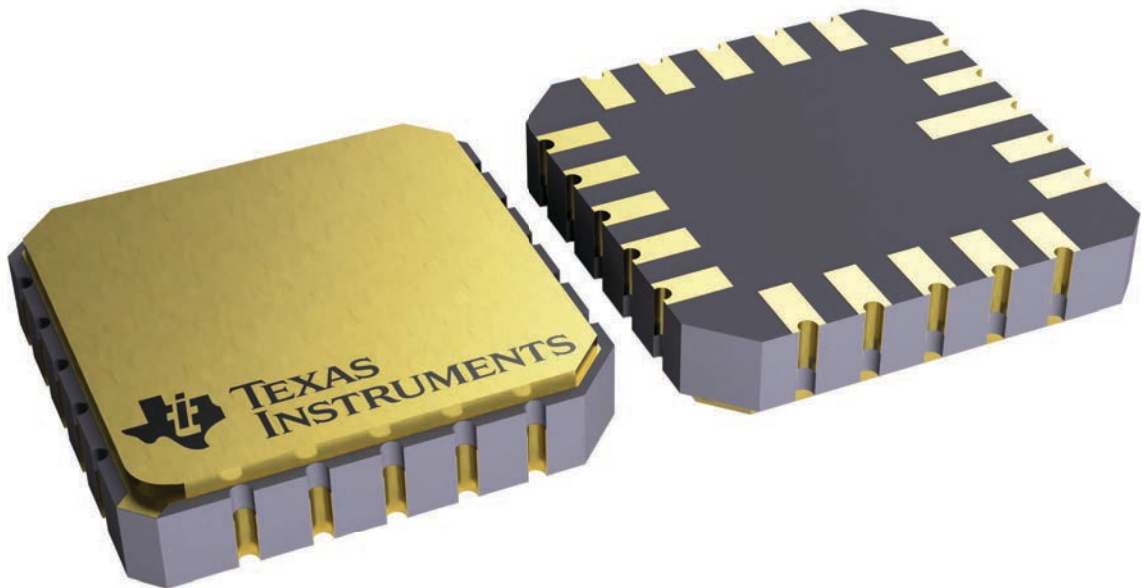

4229370VA\

J (R-GDIP-T**)

14 LEADS SHOWN

CERAMIC DUAL IN-LINE PACKAGE



DIM \ PINS **	14	16	18	20
A	0.300 (7,62) BSC	0.300 (7,62) BSC	0.300 (7,62) BSC	0.300 (7,62) BSC
B MAX	0.785 (19,94)	.840 (21,34)	0.960 (24,38)	1.060 (26,92)
B MIN	—	—	—	—
C MAX	0.300 (7,62)	0.300 (7,62)	0.310 (7,87)	0.300 (7,62)
C MIN	0.245 (6,22)	0.245 (6,22)	0.220 (5,59)	0.245 (6,22)



4040083/F 03/03

- NOTES:
- All linear dimensions are in inches (millimeters).
 - This drawing is subject to change without notice.
 - This package is hermetically sealed with a ceramic lid using glass frit.
 - Index point is provided on cap for terminal identification only on press ceramic glass frit seal only.
 - Falls within MIL STD 1835 GDIP1-T14, GDIP1-T16, GDIP1-T18 and GDIP1-T20.

N (R-PDIP-T**)

PLASTIC DUAL-IN-LINE PACKAGE

16 PINS SHOWN



- NOTES:
- A. All linear dimensions are in inches (millimeters).
 - B. This drawing is subject to change without notice.
 - Falls within JEDEC MS-001, except 18 and 20 pin minimum body length (Dim A).
 - The 20 pin end lead shoulder width is a vendor option, either half or full width.

IMPORTANT NOTICE AND DISCLAIMER

TI PROVIDES TECHNICAL AND RELIABILITY DATA (INCLUDING DATA SHEETS), DESIGN RESOURCES (INCLUDING REFERENCE DESIGNS), APPLICATION OR OTHER DESIGN ADVICE, WEB TOOLS, SAFETY INFORMATION, AND OTHER RESOURCES "AS IS" AND WITH ALL FAULTS, AND DISCLAIMS ALL WARRANTIES, EXPRESS AND IMPLIED, INCLUDING WITHOUT LIMITATION ANY IMPLIED WARRANTIES OF MERCHANTABILITY, FITNESS FOR A PARTICULAR PURPOSE OR NON-INFRINGEMENT OF THIRD PARTY INTELLECTUAL PROPERTY RIGHTS.

These resources are intended for skilled developers designing with TI products. You are solely responsible for (1) selecting the appropriate TI products for your application, (2) designing, validating and testing your application, and (3) ensuring your application meets applicable standards, and any other safety, security, regulatory or other requirements.

These resources are subject to change without notice. TI grants you permission to use these resources only for development of an application that uses the TI products described in the resource. Other reproduction and display of these resources is prohibited. No license is granted to any other TI intellectual property right or to any third party intellectual property right. TI disclaims responsibility for, and you will fully indemnify TI and its representatives against, any claims, damages, costs, losses, and liabilities arising out of your use of these resources.

TI's products are provided subject to [TI's Terms of Sale](#) or other applicable terms available either on [ti.com](https://www.ti.com) or provided in conjunction with such TI products. TI's provision of these resources does not expand or otherwise alter TI's applicable warranties or warranty disclaimers for TI products.

TI objects to and rejects any additional or different terms you may have proposed.

Mailing Address: Texas Instruments, Post Office Box 655303, Dallas, Texas 75265
Copyright © 2023, Texas Instruments Incorporated