

**Data sheet | Item number: 2210-1204**

2-conductor through terminal block; with push-button; 10 mm<sup>2</sup>; with test port; suitable for Ex i applications; side and center marking; for DIN-rail 35 x 15 and 35 x 7.5; Push-in CAGE CLAMP®; 10,00 mm<sup>2</sup>; blue

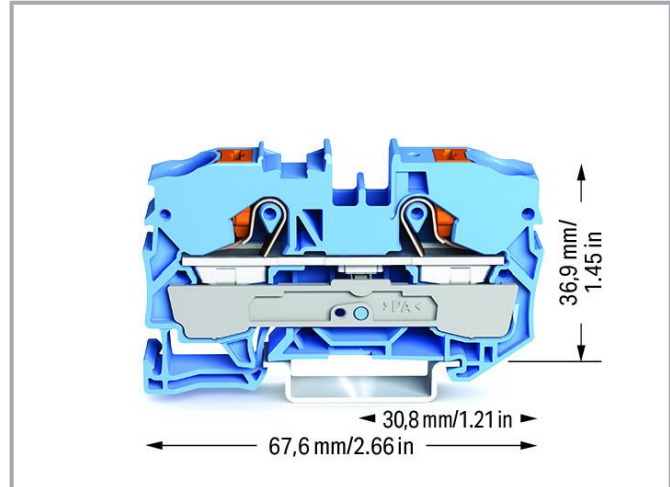

[www.wago.com/2210-1204](http://www.wago.com/2210-1204)

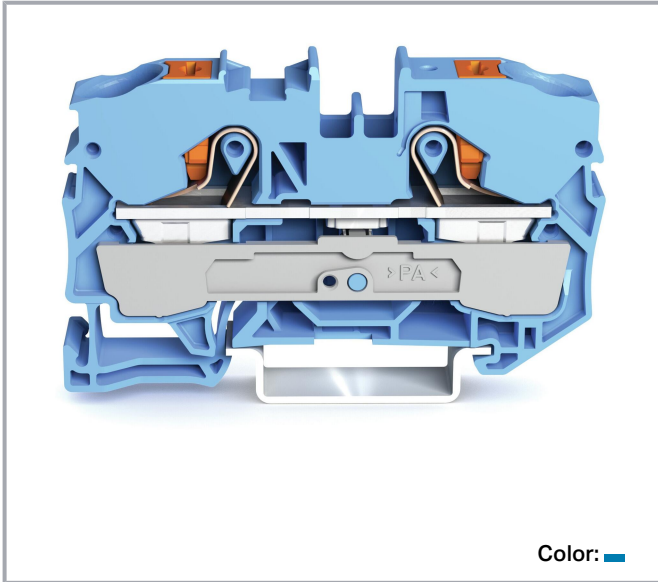

Color: 

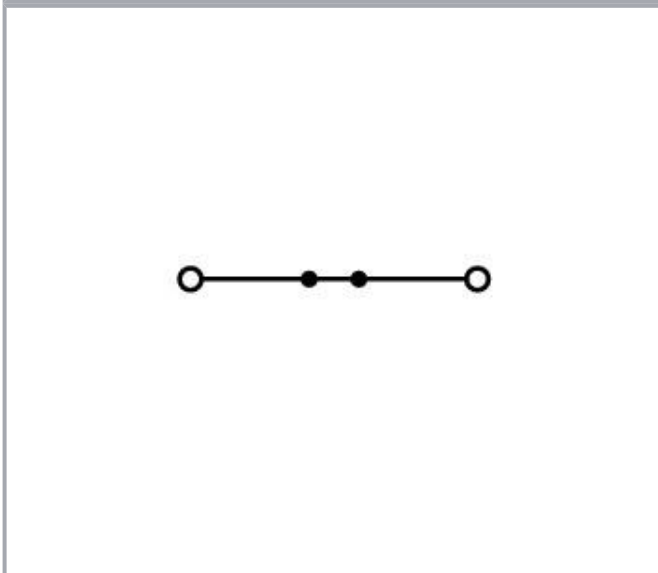

**Data**

**Electrical data**

Subject to changes. Please also observe the further product documentation!

WAGO GmbH & Co. KG  
Hansastr. 27  
32423 Minden  
Phone: +49571 887-0 | Fax: +49571 887-169  
Email: [info.de@wago.com](mailto:info.de@wago.com) | Web: [www.wago.com](http://www.wago.com)

Do you have any questions about our products?  
We are always happy to take your call at +49 (571) 887-44222.



### Ratings per IEC/EN

|   |   |
|---|---|
| Ratings per   | IEC/EN 60947-7-1  |
| Nominal voltage (III/3)                                   | 800 V   |
| Rated impulse voltage (III/3)                             | 8 kV  |
| Rated current   | 57 A  |
| Current at conductor cross-section (max.) mm <sup>2</sup> | 76 A  |
| Legend (ratings)  | (III / 3) $\hat{=}$ Overvoltage category III / Pollution degree 3 |

### Ratings per UL 1059

|                                |         |
|--------------------------------|---------|
| Approvals per                  | UL 1059 |
| Rated voltage UL (Use Group B) | 600 V   |
| Rated current UL (Use Group B) | 65 A    |
| Rated voltage UL (Use Group C) | 600 V   |
| Rated current UL (Use Group C) | 65 A    |

### Ratings per CSA

|                                 |                 |
|---------------------------------|-----------------|
| Approvals per                   | CSA 22.2 No 158 |
| Rated voltage CSA (Use Group B) | 600 V           |
| Rated current CSA (Use Group B) | 64 A            |
| Rated voltage CSA (Use Group C) | 600 V           |
| Rated current CSA (Use Group C) | 64 A            |

### Ex information

|                                     |   |
|-------------------------------------|---|
| Reference hazardous areas           | See "Downloads – Documentation – Additional Information: Technical Section; Technical Explications" |
| Ratings per                         | ATEX: PTB 18 ATEX 1008 U / IECEx: PTB 18.0015U (Ex eb IIC Gb)                                       |
| Rated voltage EN (Ex e II)          | 550 V   |
| Rated current (Ex e II)             | 54 A  |
| Rated current (Ex e II) with jumper | 50 A  |

### Power loss

|  |                |
|--|----------------|
| Power loss, per pole (potential)                             | 1.819 W        |
| Rated current $I_N$ for specified power loss                 | 57 A           |
| Resistance value for specified, current-dependent power loss | 0.001 $\Omega$ |

Subject to changes. Please also observe the further product documentation!



## Connection data

|                            |   |
|----------------------------|---|
| Connection points          | 2 |
| Total number of potentials | 1 |
| Number of levels           | 1 |
| Number of jumper slots     | 2 |

## Connection 1

|  |   |
|--|---|
| Connection technology                                      | Push-in CAGE CLAMP®   |
| Actuation type   | Push-button   |
| Connectable conductor materials                            | Copper  |
| Nominal cross-section                                      | 10 mm <sup>2</sup>  |
| Solid conductor  | 0.5 ... 16 mm <sup>2</sup> / 20 ... 6 AWG   |
| Solid conductor; push-in termination                       | 2.5 ... 16 mm <sup>2</sup> / 14 ... 6 AWG   |
| Fine-stranded conductor                                    | 0.5 ... 16 mm <sup>2</sup> / 20 ... 6 AWG   |
| Fine-stranded conductor; with insulated ferrule            | 0.5 ... 10 mm <sup>2</sup> / 20 ... 8 AWG   |
| Fine-stranded conductor; with ferrule; push-in termination | 4 ... 10 mm <sup>2</sup> / 12 ... 8 AWG   |
| Note (conductor cross-section)                             | Depending on the conductor characteristic, a conductor with a smaller cross-section can also be inserted via push-in termination. |
| Strip length   | 17 ... 19 mm / 0.67 ... 0.75 inches   |
| Wiring direction   | Front-entry wiring  |

## Physical data

|                                   |                        |
|-----------------------------------|------------------------|
| Width                             | 10 mm / 0.394 inches   |
| Height                            | 67.6 mm / 2.661 inches |
| Depth from upper-edge of DIN-rail | 36.9 mm / 1.453 inches |

## Mechanical Data

|               |                     |
|---------------|---------------------|
| Mounting type | DIN-35 rail         |
| Marking level | Center/side marking |

## Material Data

|                      |  |
|----------------------|--|
| Note (material data) | <a href="#">Information on material specifications can be found here</a> |
| Color                | blue   |
| Material group       | I  |

Subject to changes. Please also observe the further product documentation!

|                             |                  |
|-----------------------------|------------------|
| Insulation material         | Polyamide (PA66) |
| Flammability class per UL94 | V0               |
| Fire load                   | 0.408 MJ         |
| Weight                      | 19 g             |

### Environmental requirements

|                                  |                 |
|----------------------------------|-----------------|
| Processing temperature           | -35 ... +85 °C  |
| Continuous operating temperature | -60 ... +105 °C |

### Commercial data

|                       |               |
|-----------------------|---------------|
| eCl@ss 10.0           | 27-14-11-20   |
| eCl@ss 9.0            | 27-14-11-20   |
| ETIM 8.0              | EC000897      |
| ETIM 7.0              | EC000897      |
| PU (SPU)              | 25 pcs        |
| Packaging type        | box           |
| Country of origin     | DE            |
| GTIN                  | 4055143736077 |
| Customs tariff number | 85369010000   |

### Environmental Product Compliance



|                        |                         |
|------------------------|-------------------------|
| RoHS Compliance Status | Compliant, No Exemption |
|------------------------|-------------------------|

### Approvals / Certificates



#### General approvals

| Logo   | Approval                        | Additional Approval Text | Certificate name                               |
|--|---------------------------------|--------------------------|--|
|  | CCA<br>DEKRA Certification B.V. | EN 60947                 | NTR NL 7879                                    |
|  | CCC<br>CNEX                     | GB/T 3836.3              | 2020312313000173<br>(Ex eb IIC Gb, Ex eb I Mb) |
|  | CSA<br>DEKRA Certification B.V. | C22.2                    | 70175033                                       |





Subject to changes. Please also observe the further product documentation!

|  |  |          |           |
|--|--|----------|-----------|
|  | <b>KEMA/KEUR</b><br>DEKRA Certification B.V. | EN 60947 | 71-119265 |
|  | <b>UL</b><br>Underwriters Laboratories Inc.  | UL 1059  | E45172    |

## Declarations of conformity and manufacturer's declarations

| Logo   | Approval  | Additional Approval Text | Certificate name |
|--|---|--------------------------|------------------|
|  | <b>EU-Declaration of Conformity</b><br>WAGO GmbH & Co. KG | -                        | -                |
|  | <b>UK-Declaration of Conformity</b><br>WAGO GmbH & Co. KG | -                        | -                |

## Approvals for marine applications

| Logo   | Approval  | Additional Approval Text | Certificate name         |
|--|---|--------------------------|--------------------------|
|  | <b>ABS</b><br>American Bureau of Shipping               | -                        | 19-<br>HG1866350-<br>PDA |
|  | <b>BV</b><br>Bureau Veritas S.A.                        | IEC 60947                | 58186/A0<br>BV           |
|  | <b>DNV GL</b><br>Det Norske Veritas, Germanischer Lloyd | -                        | TAE00003JT               |
|  | <b>LR</b><br>Lloyds Register                            | -                        | 19/20050                 |

## Approvals for hazardous areas

| Logo | Approval    | Additional Approval Text | Certificate name |
|------|-------------|--------------------------|------------------|
|      | <b>ATEX</b> | IEC 60079-0              | PTB 18 ATEX 1008 |

Subject to changes. Please also observe the further product documentation!

WAGO GmbH & Co. KG  
Hansastr. 27  
32423 Minden  
Phone: +49571 887-0 | Fax: +49571 887-169  
Email: [info.de@wago.com](mailto:info.de@wago.com) | Web: [www.wago.com](http://www.wago.com)

Do you have any questions about our products?  
We are always happy to take your call at +49 (571) 887-44222.



Physikalisch Technische Bundesanstalt

U (II 2 G Ex eb IIC Gb  
bzw. I M 2 Ex eb I Mb)



ATEX  
UL International Demko A/S

UL 60079

E185892 (AEx eb IIC  
resp. Ex eb IIC)



CCC  
CNEX

GB/T 3836.3

2020312313000173  
(Ex eb IIC Gb, Ex eb I  
Mb)



EAC  
Brjansker Zertifizierungsstelle

TP TC 012/2011

RU C-DE.AM02.B.  
00127/19 (Ex e IIC  
Gb U)



IECEX  
Physikalisch Technische Bundesanstalt

IEC 60079

IECEX PTB 18.0015U  
(Ex eb IIC Gb and Ex  
eb I Mb)



INMETRO  
TÜV Rheinland do Brasil Ltda.

IEC 60079

TÜV 19.0821 U

## Required accessories

### End plate

End plate



Item no.: 2010-1291  
End and intermediate plate; 1 mm thick; gray

[www.wago.com/2010-1291](http://www.wago.com/2010-1291)



Item no.: 2010-1292  
End and intermediate plate; 1 mm thick; orange

[www.wago.com/2010-1292](http://www.wago.com/2010-1292)



Item no.: 209-191  
Separator for Ex e/Ex i applications; 3 mm thick; 120 mm wide; orange

[www.wago.com/209-191](http://www.wago.com/209-191)

## Optional accessories

### Mounting

Cover carrier

Subject to changes. Please also observe the further product documentation!



**Item no.: 709-169**  
Cover carrier; Type 3; gray

[www.wago.com/709-169](http://www.wago.com/709-169)

Cover



**Item no.: 709-156**  
Cover; Type 3; suitable for cover carrier, type 3; 1 m long; transparent

[www.wago.com/709-156](http://www.wago.com/709-156)

Cover

Cover



**Item no.: 2010-100**  
Finger guard; touchproof cover protects unused conductor entries; yellow

[www.wago.com/2010-100](http://www.wago.com/2010-100)

Jumpers

Jumper



**Item no.: 2010-402**  
Jumper; 2-way; insulated; light gray

[www.wago.com/2010-402](http://www.wago.com/2010-402)



**Item no.: 2010-404**  
Jumper; 4-way; insulated; light gray

[www.wago.com/2010-404](http://www.wago.com/2010-404)



**Item no.: 2010-403**  
Jumper; 3-way; insulated; light gray

[www.wago.com/2010-403](http://www.wago.com/2010-403)



**Item no.: 2010-405/011-000**  
Star point jumper; 3-way; insulated; light gray

[www.wago.com/2010-405/011-000](http://www.wago.com/2010-405/011-000)



**Item no.: 2010-405**  
Jumper; 5-way; insulated; light gray

[www.wago.com/2010-405](http://www.wago.com/2010-405)



**Item no.: 2010-435**  
Jumper; from 1 to 5; insulated; light gray

[www.wago.com/2010-435](http://www.wago.com/2010-435)



**Item no.: 2010-433**  
Jumper; from 1 to 3; insulated; light gray

[www.wago.com/2010-433](http://www.wago.com/2010-433)



**Item no.: 2010-434**  
Jumper; from 1 to 4; insulated; light gray

[www.wago.com/2010-434](http://www.wago.com/2010-434)



**Item no.: 2016-499**  
Step-down jumper; from 2016/2010 to 2010/2006/2004/2002 series; from 2216/2210 to 2210/2206 /2204/2202 series; insulated; light gray

[www.wago.com/2016-499](http://www.wago.com/2016-499)



**Item no.: 285-430**  
Step-down jumper; from 285 (35mm<sup>2</sup>) to 2016/2010 series; insulated; gray

[www.wago.com/285-430](http://www.wago.com/285-430)

Tool

Operating tool

Subject to changes. Please also observe the further product documentation!



**Item no.: 210-721**

Operating tool; Blade: 5.5 x 0.8 mm; with a partially insulated shaft; multicoloured

[www.wago.com/210-721](http://www.wago.com/210-721)

**Marking accessories**

Marking strip



**Item no.: 2009-110**

Marking strips; for Smart Printer; on reel; not stretchable; plain; snap-on type; white

[www.wago.com/2009-110](http://www.wago.com/2009-110)

Marker carrier



**Item no.: 2009-198**

Adaptor; gray

[www.wago.com/2009-198](http://www.wago.com/2009-198)

Marker



**Item no.: 2009-115/000-002**

WMB-Inline; for Smart Printer; 1500 pieces on roll; stretchable 5 - 5.2 mm; plain; snap-on type; yellow

[www.wago.com/2009-115/000-002](http://www.wago.com/2009-115/000-002)



**Item no.: 2009-115/000-007**

WMB-Inline; for Smart Printer; 1500 pieces on roll; stretchable 5 - 5.2 mm; plain; snap-on type; gray

[www.wago.com/2009-115/000-007](http://www.wago.com/2009-115/000-007)



**Item no.: 2009-115/000-017**

WMB-Inline; for Smart Printer; 1500 pieces on roll; stretchable 5 - 5.2 mm; plain; snap-on type; light green

[www.wago.com/2009-115/000-017](http://www.wago.com/2009-115/000-017)



**Item no.: 2009-115/000-023**

WMB-Inline; for Smart Printer; 1500 pieces on roll; stretchable 5 - 5.2 mm; plain; snap-on type; green

[www.wago.com/2009-115/000-023](http://www.wago.com/2009-115/000-023)



**Item no.: 2009-115/000-024**

WMB-Inline; for Smart Printer; 1500 pieces on roll; stretchable 5 - 5.2 mm; plain; snap-on type; violet

[www.wago.com/2009-115/000-024](http://www.wago.com/2009-115/000-024)



**Item no.: 2009-145/000-006**

Mini-WSB Inline; for Smart Printer; 1700 pieces on roll; stretchable 5 - 5.2 mm; plain; snap-on type; blue

[www.wago.com/2009-145/000-006](http://www.wago.com/2009-145/000-006)



**Item no.: 2009-145**

Mini-WSB Inline; for Smart Printer; 1700 pieces on roll; stretchable 5 - 5.2 mm; plain; snap-on type; white

[www.wago.com/2009-145](http://www.wago.com/2009-145)



**Item no.: 2009-145/000-002**

Mini-WSB Inline; for Smart Printer; 1700 pieces on roll; stretchable 5 - 5.2 mm; plain; snap-on type; yellow

[www.wago.com/2009-145/000-002](http://www.wago.com/2009-145/000-002)



**Item no.: 2009-145/000-007**

Mini-WSB Inline; for Smart Printer; 1700 pieces on roll; stretchable 5 - 5.2 mm; plain; snap-on type; gray

[www.wago.com/2009-145/000-007](http://www.wago.com/2009-145/000-007)

Subject to changes. Please also observe the further product documentation!

WAGO GmbH & Co. KG

Hansastr. 27

32423 Minden













Phone: +49571 887-0 | Fax: +49571 887-169

Email: [info.de@wago.com](mailto:info.de@wago.com) | Web: [www.wago.com](http://www.wago.com)

Do you have any questions about our products?

We are always happy to take your call at +49 (571) 887-44222.



|  |  |  |
|--|--|--|
|    | <p><b>Item no.: 2009-145/000-005</b><br/>                 Mini-WSB Inline; for Smart Printer; 1700 pieces on roll; stretchable 5 - 5.2 mm; plain; snap-on type; red</p>    | <a href="http://www.wago.com/2009-145/000-005">www.wago.com/2009-145/000-005</a> |
|    | <p><b>Item no.: 2009-145/000-012</b><br/>                 Mini-WSB Inline; for Smart Printer; 1700 pieces on roll; stretchable 5 - 5.2 mm; plain; snap-on type; orange</p> | <a href="http://www.wago.com/2009-145/000-012">www.wago.com/2009-145/000-012</a> |
|    | <p><b>Item no.: 2009-145/000-023</b><br/>                 Mini-WSB Inline; for Smart Printer; 1700 pieces on roll; stretchable 5 - 5.2 mm; plain; snap-on type; green</p>  | <a href="http://www.wago.com/2009-145/000-023">www.wago.com/2009-145/000-023</a> |
|    | <p><b>Item no.: 2009-145/000-024</b><br/>                 Mini-WSB Inline; for Smart Printer; 1700 pieces on roll; stretchable 5 - 5.2 mm; plain; snap-on type; violet</p> | <a href="http://www.wago.com/2009-145/000-024">www.wago.com/2009-145/000-024</a> |
|    | <p><b>Item no.: 2009-115</b><br/>                 WMB-Inline; for Smart Printer; 1500 pieces on roll; stretchable 5 - 5.2 mm; plain; snap-on type; white</p>               | <a href="http://www.wago.com/2009-115">www.wago.com/2009-115</a>                 |
|    | <p><b>Item no.: 248-501/000-006</b><br/>                 Mini-WSB marking card; as card; not stretchable; plain; snap-on type; blue</p>                                    | <a href="http://www.wago.com/248-501/000-006">www.wago.com/248-501/000-006</a>   |
|   | <p><b>Item no.: 248-501/000-007</b><br/>                 Mini-WSB marking card; as card; not stretchable; plain; snap-on type; gray</p>                                    | <a href="http://www.wago.com/248-501/000-007">www.wago.com/248-501/000-007</a>   |
|  | <p><b>Item no.: 248-501/000-002</b><br/>                 Mini-WSB marking card; as card; not stretchable; plain; snap-on type; yellow</p>                                  | <a href="http://www.wago.com/248-501/000-002">www.wago.com/248-501/000-002</a>   |
|  | <p><b>Item no.: 248-501/000-012</b><br/>                 Mini-WSB marking card; as card; not stretchable; plain; snap-on type; orange</p>                                  | <a href="http://www.wago.com/248-501/000-012">www.wago.com/248-501/000-012</a>   |
|  | <p><b>Item no.: 248-501</b><br/>                 Mini-WSB marking card; as card; not stretchable; plain; snap-on type; white</p>   | <a href="http://www.wago.com/248-501">www.wago.com/248-501</a>                   |
|  | <p><b>Item no.: 248-501/000-017</b><br/>                 Mini-WSB marking card; as card; not stretchable; plain; snap-on type; light green</p>                             | <a href="http://www.wago.com/248-501/000-017">www.wago.com/248-501/000-017</a>   |
|  | <p><b>Item no.: 248-501/000-005</b><br/>                 Mini-WSB marking card; as card; not stretchable; plain; snap-on type; red</p>                                     | <a href="http://www.wago.com/248-501/000-005">www.wago.com/248-501/000-005</a>   |

Subject to changes. Please also observe the further product documentation!



**Item no.:** 248-501/000-024

Mini-WSB marking card; as card; not stretchable; plain; snap-on type; violet

[www.wago.com/248-501/000-024](http://www.wago.com/248-501/000-024)



**Item no.:** 248-501/000-023

Mini-WSB marking card; as card; not stretchable; plain; snap-on type; green

[www.wago.com/248-501/000-023](http://www.wago.com/248-501/000-023)



**Item no.:** 793-5501/000-007

WMB marking card; as card; for terminal block width 5 - 17.5 mm; stretchable 5 - 5.2 mm; plain; snap-on type; gray

[www.wago.com/793-5501/000-007](http://www.wago.com/793-5501/000-007)



**Item no.:** 793-5501/000-012

WMB marking card; as card; for terminal block width 5 - 17.5 mm; stretchable 5 - 5.2 mm; plain; snap-on type; orange

[www.wago.com/793-5501/000-012](http://www.wago.com/793-5501/000-012)



**Item no.:** 793-5501/000-017

WMB marking card; as card; for terminal block width 5 - 17.5 mm; stretchable 5 - 5.2 mm; plain; snap-on type; light green

[www.wago.com/793-5501/000-017](http://www.wago.com/793-5501/000-017)



**Item no.:** 793-5501/000-023

WMB marking card; as card; for terminal block width 5 - 17.5 mm; stretchable 5 - 5.2 mm; plain; snap-on type; green

[www.wago.com/793-5501/000-023](http://www.wago.com/793-5501/000-023)



**Item no.:** 793-5501/000-024

WMB marking card; as card; for terminal block width 5 - 17.5 mm; stretchable 5 - 5.2 mm; plain; snap-on type; violet

[www.wago.com/793-5501/000-024](http://www.wago.com/793-5501/000-024)



**Item no.:** 793-501/000-002

WMB marking card; as card; not stretchable; plain; snap-on type; yellow

[www.wago.com/793-501/000-002](http://www.wago.com/793-501/000-002)



**Item no.:** 793-501/000-007

WMB marking card; as card; not stretchable; plain; snap-on type; gray

[www.wago.com/793-501/000-007](http://www.wago.com/793-501/000-007)



**Item no.:** 793-501/000-017

WMB marking card; as card; not stretchable; plain; snap-on type; light green

[www.wago.com/793-501/000-017](http://www.wago.com/793-501/000-017)



**Item no.:** 793-501/000-012

WMB marking card; as card; not stretchable; plain; snap-on type; orange

[www.wago.com/793-501/000-012](http://www.wago.com/793-501/000-012)

Subject to changes. Please also observe the further product documentation!

WAGO GmbH & Co. KG

Hansastr. 27

32423 Minden

Phone: +49571 887-0 | Fax: +49571 887-169

Email: [info.de@wago.com](mailto:info.de@wago.com) | Web: [www.wago.com](http://www.wago.com)

Do you have any questions about our products?

We are always happy to take your call at +49 (571) 887-44222.



**Item no.: 793-501/000-023**  
WMB marking card; as card; not stretchable; plain; snap-on type; green

[www.wago.com/793-501/000-023](http://www.wago.com/793-501/000-023)



**Item no.: 793-501/000-006**  
WMB marking card; as card; not stretchable; plain; snap-on type; blue

[www.wago.com/793-501/000-006](http://www.wago.com/793-501/000-006)



**Item no.: 793-501/000-005**  
WMB marking card; as card; not stretchable; plain; snap-on type; red

[www.wago.com/793-501/000-005](http://www.wago.com/793-501/000-005)



**Item no.: 793-501**  
WMB marking card; as card; not stretchable; plain; snap-on type; white

[www.wago.com/793-501](http://www.wago.com/793-501)



**Item no.: 793-501/000-024**  
WMB marking card; as card; not stretchable; plain; snap-on type; violet

[www.wago.com/793-501/000-024](http://www.wago.com/793-501/000-024)



**Item no.: 793-5501/000-005**  
WMB marking card; as card; for terminal block width 5 - 17.5 mm; stretchable 5 - 5.2 mm; plain; snap-on type; red

[www.wago.com/793-5501/000-005](http://www.wago.com/793-5501/000-005)



**Item no.: 793-5501/000-002**  
WMB marking card; as card; for terminal block width 5 - 17.5 mm; stretchable 5 - 5.2 mm; plain; snap-on type; yellow

[www.wago.com/793-5501/000-002](http://www.wago.com/793-5501/000-002)

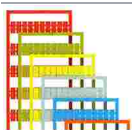

**Item no.: 793-5501/000-006**  
WMB marking card; as card; for terminal block width 5 - 17.5 mm; stretchable 5 - 5.2 mm; plain; snap-on type; blue

[www.wago.com/793-5501/000-006](http://www.wago.com/793-5501/000-006)



**Item no.: 793-5501**  
WMB marking card; as card; for terminal block width 5 - 17.5 mm; stretchable 5 - 5.2 mm; plain; snap-on type; white

[www.wago.com/793-5501](http://www.wago.com/793-5501)



**Item no.: 2009-115/000-012**  
WMB-Inline; for Smart Printer; 1500 pieces on roll; stretchable 5 - 5.2 mm; plain; snap-on type; orange

[www.wago.com/2009-115/000-012](http://www.wago.com/2009-115/000-012)



**Item no.: 2009-115/000-006**  
WMB-Inline; for Smart Printer; 1500 pieces on roll; stretchable 5 - 5.2 mm; plain; snap-on type; blue

[www.wago.com/2009-115/000-006](http://www.wago.com/2009-115/000-006)















Group marker carrier

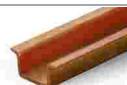

**Item no.: 2009-193**  
Group marker carrier; gray

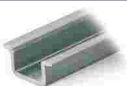
[www.wago.com/2009-193](http://www.wago.com/2009-193)

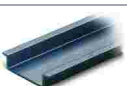
Subject to changes. Please also observe the further product documentation!

|  |  |  |
|--|--|--|
|    | <b>Item no.: 2009-192</b><br>Group marker carrier; gray  | <a href="http://www.wago.com/2009-192">www.wago.com/2009-192</a> |
|    | <b>Item no.: 2009-191</b><br>Group marker carrier; gray  | <a href="http://www.wago.com/2009-191">www.wago.com/2009-191</a> |
| <b>Ferrule</b>   |  |  |
| Ferrule  |  |  |
|    | <b>Item no.: 216-284</b><br>Ferrule; Sleeve for 1.5 mm <sup>2</sup> / AWG 16; insulated; electro-tin plated; electrolytic copper; gastight crimped; acc. to DIN 46228, Part 4/09.90; black | <a href="http://www.wago.com/216-284">www.wago.com/216-284</a>   |
|    | <b>Item no.: 216-286</b><br>Ferrule; Sleeve for 2.5 mm <sup>2</sup> / AWG 14; insulated; electro-tin plated; electrolytic copper; gastight crimped; acc. to DIN 46228, Part 4/09.90; blue  | <a href="http://www.wago.com/216-286">www.wago.com/216-286</a>   |
|    | <b>Item no.: 216-287</b><br>Ferrule; Sleeve for 4 mm <sup>2</sup> / AWG 12; insulated; electro-tin plated; electrolytic copper; gastight crimped; acc. to DIN 46228, Part 4/09.90; gray    | <a href="http://www.wago.com/216-287">www.wago.com/216-287</a>   |
|    | <b>Item no.: 216-288</b><br>Ferrule; Sleeve for 6 mm <sup>2</sup> / AWG 10; insulated; electro-tin plated; electrolytic copper; gastight crimped; acc. to DIN 46228, Part 4/09.90; yellow  | <a href="http://www.wago.com/216-288">www.wago.com/216-288</a>   |
|    | <b>Item no.: 216-289</b><br>Ferrule; Sleeve for 10 mm <sup>2</sup> / AWG 8; insulated; electro-tin plated; electrolytic copper; gastight crimped; acc. to DIN 46228, Part 4/09.90; red     | <a href="http://www.wago.com/216-289">www.wago.com/216-289</a>   |
| <b>Carrier rail</b>  |  |  |
| Mounting accessories   |  |  |
|  | <b>Item no.: 210-197</b><br>Steel carrier rail; 35 x 15 mm; 1.5 mm thick; 2 m long; slotted; similar to EN 60715; silver-colored   | <a href="http://www.wago.com/210-197">www.wago.com/210-197</a>   |
|  | <b>Item no.: 210-198</b><br>Copper carrier rail; 35 x 15 mm; 2.3 mm thick; 2 m long; unslotted; according to EN 60715; copper-colored  | <a href="http://www.wago.com/210-198">www.wago.com/210-198</a>   |
|  | <b>Item no.: 210-113</b><br>Steel carrier rail; 35 x 7.5 mm; 1 mm thick; 2 m long; unslotted; according to EN 60715; silver-colored  | <a href="http://www.wago.com/210-113">www.wago.com/210-113</a>   |
|  | <b>Item no.: 210-118</b><br>Steel carrier rail; 35 x 15 mm; 2.3 mm thick; 2 m long; unslotted; according to EN 60715; silver-colored   | <a href="http://www.wago.com/210-118">www.wago.com/210-118</a>   |
|  | <b>Item no.: 210-114</b><br>Steel carrier rail; 35 x 15 mm; 1.5 mm thick; 2 m long; unslotted; similar to EN 60715; silver-colored   | <a href="http://www.wago.com/210-114">www.wago.com/210-114</a>   |
|  | <b>Item no.: 210-196</b><br>Aluminum carrier rail; 35 x 8.2 mm; 1.6 mm thick; 2 m long; unslotted; similar to EN 60715; silver-colored   | <a href="http://www.wago.com/210-196">www.wago.com/210-196</a>   |
| <b>Testing and measuring</b>   |  |  |
| Testing accessories  |  |  |
|  | <b>Item no.: 2009-174</b><br>Test plug adapter; for 4 mm Ø test plugs; for testing TOPJOB®S rail-mounted terminal blocks; gray   | <a href="http://www.wago.com/2009-174">www.wago.com/2009-174</a> |

Subject to changes. Please also observe the further product documentation!



**Item no.: 2009-182**

Testing tap; for max. 2.5 mm<sup>2</sup>; tool-free connection for individual test wires 0.08 - 2.5 mm; gray

[www.wago.com/2009-182](http://www.wago.com/2009-182)



**Item no.: 2010-511**

Modular TOPJOB<sup>®</sup>S connector; modular; for jumper contact slot; 1-pole; 4,00 mm<sup>2</sup>; gray

[www.wago.com/2010-511](http://www.wago.com/2010-511)



**Item no.: 2010-549**

Spacer module; modular; e.g., for bridging commoned terminal blocks; gray

[www.wago.com/2010-549](http://www.wago.com/2010-549)

## Downloads

### Documentation

#### Bid Text

|                           |             |                 |          |
|---------------------------|-------------|-----------------|----------|
| 2210-1204<br>docx - Datei | 2019 Apr 15 | docx<br>15.4 kB | Download |
| 2210-1204<br>X81 - Datei  | 2019 Apr 15 | xml<br>4.1 kB   | Download |

#### Additional Information

|   |  |               |          |
|---|--|---------------|----------|
| Technical Section<br>Technical explanations |  | pdf<br>2.2 MB | Download |
|---|--|---------------|----------|

## CAD/CAE-Data

### CAD data

|                        |  |     |          |
|------------------------|--|-----|----------|
| 2D/3D Models 2210-1204 |  | URL | Download |
|------------------------|--|-----|----------|

### CAE data

|                             |  |     |          |
|-----------------------------|--|-----|----------|
| EPLAN Data Portal 2210-1204 |  | URL | Download |
|-----------------------------|--|-----|----------|

|                        |  |     |          |
|------------------------|--|-----|----------|
| ZUKEN Portal 2210-1204 |  | URL | Download |
|------------------------|--|-----|----------|

## Environmental Product Compliance

### Compliance Search

|  |  |     |          |
|--|--|-----|----------|
| Environmental Product Compliance 2210-1204 |  | URL | Download |
|--|--|-----|----------|

Subject to changes. Please also observe the further product documentation!

2-conductor through terminal block; with push-button; 10 mm<sup>2</sup>; with test port; suitable for Ex i applications; side and center marking; for DIN-rail 35 x 15 and 35 x 7.5; Push-in CAGE CLAMP®; 10,00 mm<sup>2</sup>; blue

## Installation Notes

### Conductor termination

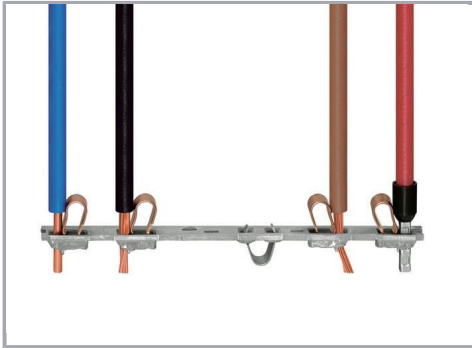

All conductor types at a glance



Push-in termination of solid and ferruled conductors



Insert fine-stranded conductors via operating tool.



Removing all conductors via operating tool.

### Commoning

Subject to changes. Please also observe the further product documentation!

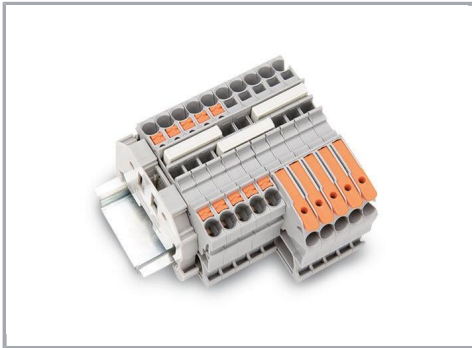

Insert a push-in type jumper bar and push down until it hits the backstop.

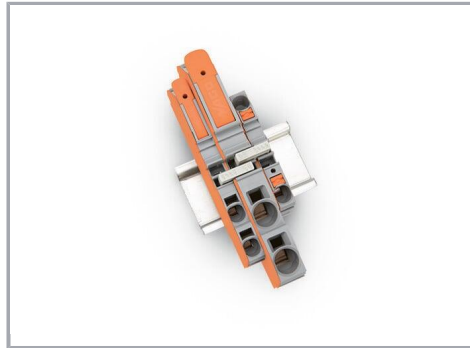

Commoning with step-down jumpers.

### Testing

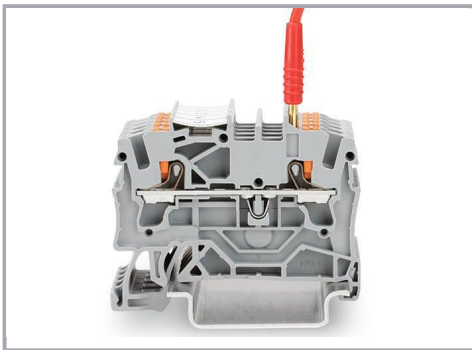

Testing with a 2 mm Ø test plug (max. 42 V).

### Marking

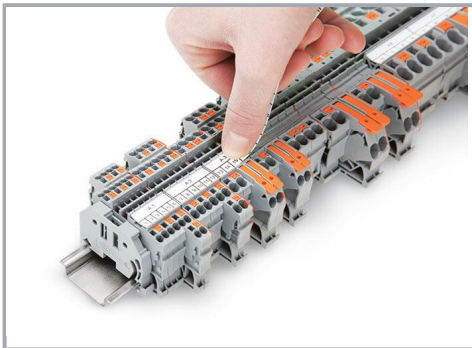

Snapping a marking strip into a marker slot.

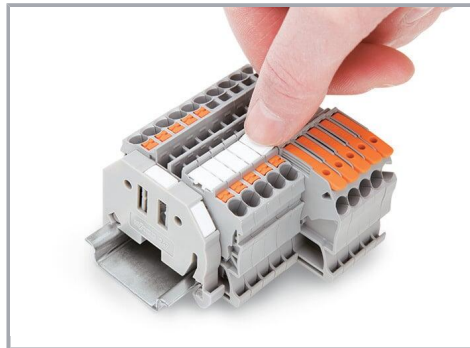

Snapping a marking strip into the marker slot.

### Product family

#### TOPJOB® S

TOPJOB® S: In various industrial applications and modern building installations, WAGO's wide and versatile range of rail-mount terminal blocks provides more than just reliable electrical connections.

Subject to changes. Please also observe the further product documentation!



[Show all products from the family](#)

Subject to changes. Please also observe the further product documentation!

---

WAGO GmbH & Co. KG  
Hansastr. 27  
32423 Minden  
Phone: +49571 887-0 | Fax: +49571 887-169  
Email: [info.de@wago.com](mailto:info.de@wago.com) | Web: [www.wago.com](http://www.wago.com)

Do you have any questions about our products?  
We are always happy to take your call at +49 (571) 887-44222.