

SUMMARY

Wires

Low voltage 4



Image is for illustrative purpose only

Series	SP
Termination type	Female solder
IP rating	50
AWG wire size	28.00 - 20.00
Cable Ø	2.50 - 7.50 mm
Status	active
Matching parts	SAN.M04.GLA.6A

Download

[Request a quote](#)

[Catalog](#)

TECHNICAL DETAILS

Mechanics

Shell Style/Model	SL_.SP*: Fixed socket, key (N) or keys (P, S and T), nut fixing, blue front nut
Keying	3 keys (alpha=0, gamma=30, plug: male contacts, receptacle: female contacts)
Housing Material	Proprietary sulfone, gray
Variant	A : Blue front nut
Weight	3.09 g

Performance

Configuration	SP.M04 : 4 Low V.
Insulator	L: PEEK (UL 94 / V-0/1.5)
Rated Current	11.5 Amps

Specifications

Contact Type: Solder
Contact Dia.: 1.3 mm (0.0512in)
Bucket Dia.: 1.1 mm (0.04in)
Min. Conductor: 0.36 mm² (AWG 22)
Max. Conductor: 1 mm² (AWG 18)
Test voltage (kV rms) Contact-contact: 1.60
Air clearance min.: 0.96 mm

LEMO products and services are provided "as is". LEMO makes no warranties or representations with regard to LEMO product & services or use of them, express, implied or statutory, including for accuracy, completeness, or security. The user is fully responsible for his products and applications using LEMO components.

Creepage distance min.: 0.96 mm

Others

Endurance (Shell): >2000 mating cycles

Temp (min / max): -50°C / +170°C

DRAWINGS

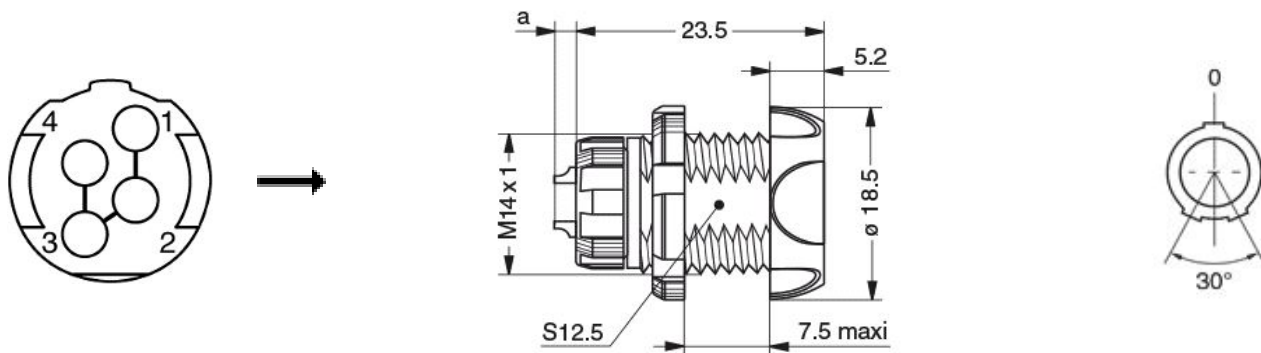

Dimensions

	B	N	a	e
mm.	18.5	23.5	2.2	M14x1
in.	0,73	0,93	0,09	





















RECOMMENDED BY LEMO

Tools

Cables

CMN.04.T20.053PGZE		Grey	
CMN.04.T20.053PNZE			
CMN.04.T20.053QGZE	TPR (medical)	Grey	

LEMO products and services are provided "as is". LEMO makes no warranties or representations with regard to LEMO product & services or use of them, express, implied or statutory, including for accuracy, completeness, or security. The user is fully responsible for his products and applications using LEMO components.

CMN.04.T22.047QGC	TPR	Grey	
CMN.04.T22.048QGZE	TPR (medical)	Grey	
CMN.04.T28.031PGCE	PVC	GREY	
CMN.04.T28.031PGZE		Grey	
CMN.04.T28.031PNCE	PVC	Black	
CMN.04.T28.031PNZE			
CMN.04.T28.031QGC	TPR	Grey	
140240	PVC	Black	
140250	PVC	Grey	
240500	PVC	Grey	
240750	PVC	Grey	
40080	PVC	Black	
40086	PVC	Blue	
40140	PVC	Black	
40240	PTFE	White	
40260	PVC	Black	
4041	PVC	Grey	
4050	PVC	Black	
4080	PVC	Grey	
417920	PVC	Grey	
4220	PVC	Black	
4221	PVC	Black	
4260	PTFE	White	
4280	PVC	Black	
80080	PVC	Grey	
80082	PVC	Red	
80084	PVC	Black	
CTR.75.030.121870G	PVC	Grey	

LEMO products and services are provided "as is". LEMO makes no warranties or representations with regard to LEMO product & services or use of them, express, implied or statutory, including for accuracy, completeness, or security. The user is fully responsible for his products and applications using LEMO components.