



User Manual

RSB-6410

**NXP ARM® Cortex®-A9 i.MX6
Dual/Quad Mini-ITX Motherboard**

ADVANTECH

Enabling an Intelligent Planet

Copyright

The documentation and the software included with this product are copyrighted 2016 by Advantech Co., Ltd. All rights are reserved. Advantech Co., Ltd. reserves the right to make improvements in the products described in this manual at any time without notice. No part of this manual may be reproduced, copied, translated or transmitted in any form or by any means without the prior written permission of Advantech Co., Ltd. Information provided in this manual is intended to be accurate and reliable. However, Advantech Co., Ltd. assumes no responsibility for its use, nor for any infringements of the rights of third parties, which may result from its use.

Acknowledgements

ARM is trademarks of ARM Corporation.

NXP is trademarks of NXP Corporation.

All other product names or trademarks are properties of their respective owners.

Product Warranty (2 years)

Advantech warrants to you, the original purchaser, that each of its products will be free from defects in materials and workmanship for two years from the date of purchase.

This warranty does not apply to any products which have been repaired or altered by persons other than repair personnel authorized by Advantech, or which have been subject to misuse, abuse, accident or improper installation. Advantech assumes no liability under the terms of this warranty as a consequence of such events.

Because of Advantech's high quality-control standards and rigorous testing, most of our customers never need to use our repair service. If an Advantech product is defective, it will be repaired or replaced at no charge during the warranty period. For out-of-warranty repairs, you will be billed according to the cost of replacement materials, service time and freight. Please consult your dealer for more details.

If you think you have a defective product, follow these steps:

1. Collect all the information about the problem encountered. (For example, CPU speed, Advantech products used, other hardware and software used, etc.) Note anything abnormal and list any onscreen messages you get when the problem occurs.
2. Call your dealer and describe the problem. Please have your manual, product, and any helpful information readily available.
3. If your product is diagnosed as defective, obtain an RMA (return merchandise authorization) number from your dealer. This allows us to process your return more quickly.
4. Carefully pack the defective product, a fully-completed Repair and Replacement Order Card and a photocopy proof of purchase date (such as your sales receipt) in a shippable container. A product returned without proof of the purchase date is not eligible for warranty service.
5. Write the RMA number visibly on the outside of the package and ship it prepaid to your dealer.

Declaration of Conformity

FCC Class A

Note: This equipment has been tested and found to comply with the limits for a Class A digital device, pursuant to part 15 of the FCC Rules. These limits are designed to provide reasonable protection against harmful interference when the equipment is operated in a commercial environment. This equipment generates, uses, and can radiate radio frequency energy and, if not installed and used in accordance with the instruction manual, may cause harmful interference to radio communications. Operation of this equipment in a residential area is likely to cause harmful interference in which case the user will be required to correct the interference at his own expense.

Packing List

Before installation, please ensure the following items have been shipped.

- 1 x RSB-6410 Mini-ITX motherboard
- 1 x D-SUB 9P debug cable
- 1 x 1-to-2 serial port cable
- 1 x IO Port bracket

Optional Accessories

Part No.	Description
96PSA-A36W12R1	A/D 100 ~ 240 V, 36 W, 12 V
1700001524	Power cord 3P UL 10A 125 V 180 cm
170203180A	Power Code 3P UK 2.5A/3A 250V 1.83cm
170203183C	Power Code 3P Europe 183cm
IDK-1107WR-40WVA1E	7" LED PANEL 400N with 4WR touch, 800 x 480 (G)
1700025779-01	LVDS cable for IDK-1107WR
1700025767-01	LCD black light cable for IDK-1107WR
SQF-ISDS1-4G-82C	SQFlash SD card 4G
Y5AGF16002	WiFi/BT module AW-CB178NF-S
9680017201	Quectel 3G module UC20-G
PCIE-1602C	2-Port RS232/422/485 PCIE card

Ordering Information

Commercial Grade		
Part No.	RSB-6410CD-PNA1E	RSB-6410CQ-VNA1E
CPU	i.MX6D	i.MX6Q
Memory	1G	2G
EMMC	8GB	8GB
Nor Flash	4MB	4MB
LVDS	1 x 24bit dual channel LVDS with up to 1920x1080 resolution, 2 x 24bit single channel LVDS with up to 1366x768 resolution (option)	
HDMI	1920 x 1080	
VGA	1920 x 1080	
USB	6	6
Giga LAN	1	1
I2C	3	3
GPIO	20	20
RS232	4	4
RS232/422/485	1	1
Mini-PCIE	1	1
PCIEx1	1	1
M.2	1	1
CAN	1	1
SD	1	1
SATA	1	1
Audio	1 x Line out 1 x Mic 1 x Amplifier 6W	1 x Line out 1 x Mic 1 x Amplifier 6W
Operation Temp.	0 ~60°C	0 ~60°C

Safety Instructions

1. Read these safety instructions carefully.
2. Keep this User Manual for later reference.
3. Disconnect this equipment from any AC outlet before cleaning. Use a damp cloth. Do not use liquid or spray detergents for cleaning.
4. For plug-in equipment, the power outlet socket must be located near the equipment and must be easily accessible.
5. Keep this equipment away from humidity.
6. Put this equipment on a reliable surface during installation. Dropping it or letting it fall may cause damage.
7. The openings on the enclosure are for air convection. Protect the equipment from overheating. **DO NOT COVER THE OPENINGS.**
8. Make sure the voltage of the power source is correct before connecting the equipment to the power outlet.
9. Position the power cord so that people cannot step on it. Do not place anything over the power cord.
10. All cautions and warnings on the equipment should be noted.
11. If the equipment is not used for a long time, disconnect it from the power source to avoid damage by transient overvoltage.
12. Never pour any liquid into an opening. This may cause fire or electrical shock.
13. Never open the equipment. For safety reasons, the equipment should be opened only by qualified service personnel.
14. If one of the following situations arises, get the equipment checked by service personnel:
 - The power cord or plug is damaged.
 - Liquid has penetrated into the equipment.
 - The equipment has been exposed to moisture.
 - The equipment does not work well, or you cannot get it to work according to the user's manual.
 - The equipment has been dropped and damaged.
 - The equipment has obvious signs of breakage.

DISCLAIMER: This set of instructions is given according to IEC 704-1. Advantech disclaims all responsibility for the accuracy of any statements contained herein.

Safety Precaution – Static Electricity

Follow these simple precautions to protect yourself from harm and the products from damage.

- To avoid electrical shock, always disconnect the power from your PC chassis before you work on it. Don't touch any components on the CPU card or other cards while the PC is on.

Contents

Chapter 1	General Introduction	1
1.1	Introduction	2
1.2	Product Features.....	2
1.3	Mechanical Specifications.....	3
1.4	Electrical Specifications	3
1.5	Environmental Specifications.....	3
1.6	Block Diagram.....	3
Chapter 2	H/W Installation.....	5
2.1	Jumpers	6
2.1.1	Jumper Description	6
2.1.2	Jumper List	6
	Table 2.1: Jumper List.....	6
2.1.3	Jumper Settings.....	7
2.2	Connectors.....	12
2.2.1	Connector List.....	12
2.2.2	Connector Settings	12
2.2.3	UART2 COM port (COM2).....	17
2.3	LED	31
2.4	Mechanical.....	31
2.4.1	Jumper and Connector Locations	31
2.4.2	Board Dimensions.....	33
2.5	Quick Start of RSB-6410.....	34
2.5.1	Debug Port Connection.....	34
2.5.2	Debug Port setting	34
	Figure 2.1 Hyper Terminal Settings for Terminal Setup	34
Chapter 3	Software Functionality	35
3.1	Test Tools	36
3.2	eMMC Test.....	36
3.3	USB Test.....	36
3.4	SD Test	37
3.5	GPIO Test	38
3.6	I2C Test.....	39
3.7	LAN Test	40
3.8	UART Test	41
3.9	Can Test.....	43
3.10	Display Output Setting	43
3.10.1	Single Display Settings	43
3.10.2	Dual Display Settings.....	44
3.10.3	Triple Display Settings	45
Chapter 4	Android OS.....	47
4.1	Introduction	48
4.2	Board Support Package	48
4.2.1	Pre-built System Image.....	48
4.2.2	Source Code Package	48
4.3	Set up Build Environment.....	49
4.3.1	Installing JDK.....	49

	4.3.2	Installing Required Packages	49
	4.3.3	Toolchain setup	49
4.4		Build Instructions.....	50
	4.4.1	Build android.....	50
	4.4.2	Build android kernel.....	50
	4.4.3	Build android system image.....	50
	4.4.4	Build android recovery image	50
	4.4.5	Build android OTA package.....	51
4.5		Debug Console	51
4.6		Boot up from SD card or eMMC.....	51
	4.6.1	The storages devices name as following:.....	51
	4.6.2	Create a bootable SD card	51
	4.6.3	Transfer the whole system to onboard eMMC.....	52
4.7		Customization	52
	4.7.1	Config Android Kernel.....	52
	4.7.2	Put source code to system	53
4.8		Serial Port Test	54
	4.8.1	Setup Serial Port.....	54
	4.8.2	Console Test.....	55
	4.8.3	Loopback Test	56
	4.8.4	Send01010101 Test	56
4.9		Network Setup	57
	4.9.1	Wi-Fi	57
	4.9.2	Bluetooth.....	60
	4.9.3	3G/4G	62
	4.9.4	Ethernet	62
4.10		Can Test	63
4.11		System Update	64
4.12		System Reset.....	65
4.13		Watchdog Function	67

Chapter 5 Advantech Services 69

5.1	RISC Design-in Services	70
5.2	Contact Information.....	73
5.3	Global Service Policy	74
	5.3.1 Warranty Policy.....	74
	5.3.2 Repair Process	75

Chapter 1

General Introduction

This chapter gives background information on the RSB-6410.

Sections include:

- Introduction
- Specifications

1.1 Introduction

RSB-6410 is the world's first RISC-based Mini-ITX motherboard computer which integrates an NXP i.MX6D/Q Cortex-A9 1.0GHz high performance processor. This embedded motherboard provides the ideal solution for industrial applications such as machine control and self-service machine systems that require high performance graphic interfaces, multiple I/O and networking connectivity but with low power consumption.

RSB-6410 builds on the standard 170 mm x 170 mm Mini-ITX form factor with abundant connectivity for multiple I/O including 6 x USB 2.0, 5 x COM, 20 x GPIOs, 1 x Gigabit Ethernet port and 1 x PCIe slot for extending I/O module. RSB-6410 also features wireless connectivity, including 1 x M.2 E-key slot for WiFi and BT modules, and 1 x Mini-PCIe for 3G/4G modules. The system also supports triple displays for LVDS, HDMI and VGA and there is sample code in the BSP to help customers build their own applications.

RSB-6410 is not only the best hardware solution for the industrial market, but also be flexible enough to be applied to various applications such as kiosks, ATM/VTM, Industry controllers and IoT device related applications.

1.2 Product Features

Form factor		RISC Mini-ITX
Processor System	CPU	NXP i.MX6D/Q
Memory	Technology	DDR3 1066MHz
	Capacity	On-board 1GB/2GB
	Flash	8GB eMMC for O.S. and 4MB NOR Flash for ADV Loader
Graphic	LVDS	1 x 24-bit dual channel LVDS with up to 1920x1080 resolution, 2 x 24bit single channel LVDS with up to 1366x768 resolution (option)
	HDMI	1920 x 1080
	VGA	1920 x 1080
Ethernet	Transceiver	NXP i.MX6 integrated RGMII
	Speed	1 x 10/100/1000 Mbps
Watch Dog Timer	HW WDT	8051F396 (time out 1~65535s, default 60s)
I/O	SDIO	1 x 4-bit STD SD
	Serial Port	5 x COM (3 x 4 wire RS232, 1 x 2 wire RS232/debug port by jumper, 1 x 4 wire RS232/422/RS485)
	M.2	1 x M.2 for WiFi/BT cards
	CAN	1 x CAN 2.0
	GPIO	20 x GPIO
	I2C	3 x I2C
	SATA	1
	USB	6 x USB 2.0 host
	Audio	1 x Line out 1 x Mic 1 x Amplifier 6W
Expansion Slot	Mini-PCIe	1 (USB signal only)
	PCIE	1

O.S	Android	V 4.4.2, Kernel V3.0.35
	Linux	Yocto1.7, Kernel V3.14.28,
Dimensions	W x L x T	170 x 170mm x 1.6mm
Power	DC-In	12V DC-In
Environment	Operational Temperature	0 ~ 60°C
	Operating Humidity	5% ~ 95% relative humidity, non-condensing
Certifications	Level	CE / FCC Class B

1.3 Mechanical Specifications

- **Dimension:** 170x170 mm (6.69" x 6.69")
- **Height:** 16 mm
- **Reference Weight:** 640g (including whole package)

1.4 Electrical Specifications

- **Power supply type:** DC-in 12V
- **RTC Battery:**
 - Typical voltage: 3V
 - Normal discharge capacity: 240 mAh

1.5 Environmental Specifications

- **Operating temperature:** 0~60°C (32~140~60°F)
- **Operating humidity:** 5% ~ 95% relative humidity, non-condensing
- **Storage temperature:** -40~85°C (-40~185°F)
- **Storage humidity:** 60°C @ 95% RH Non-condensing

1.6 Block Diagram

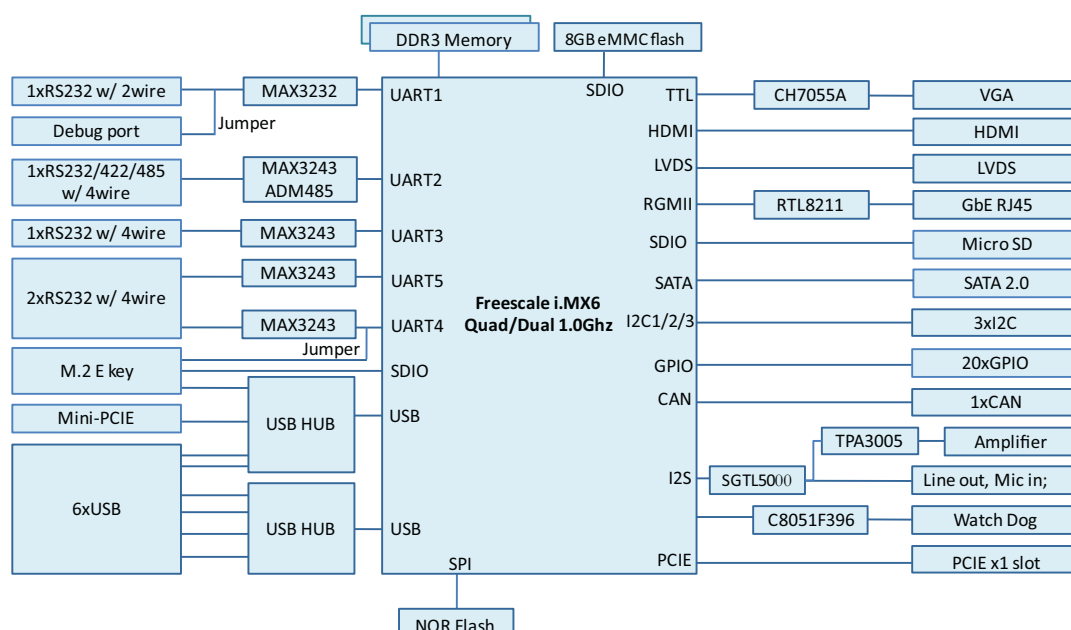

Chapter 2

H/W Installation

This chapter gives mechanical and connector information on the RSB-6410.

Sections include:

- Jumper Information
- Connector Information
- Mechanical Drawing
- Quick Start Guide

2.1 Jumpers

2.1.1 Jumper Description

Cards can be configured by setting jumpers. A jumper is a metal bridge used to close an electric circuit. It consists of two metal pins and a small metal clip (often protected by a plastic cover) that slides over the pins to connect them. To close a jumper, you connect the pins with the clip. To open a jumper, you remove the clip. Sometimes a jumper will have three pins, labeled 1, 2 and 3. In this case you would connect either pins 1 and 2 or 2 and 3.

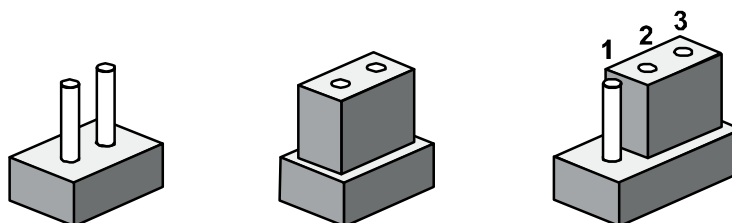

The jumper settings are schematically depicted in this manual as follows.

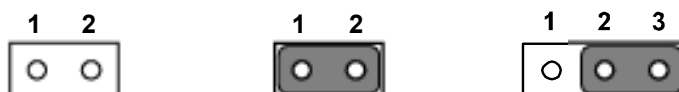

A pair of needle-nose pliers may be helpful when working with jumpers. If you have any doubts about the best hardware configuration for your application, contact your local distributor or sales representative before you make any changes. Generally, you simply need a standard cable to make most connections.

Warning! To avoid damaging the computer, always turn off the power supply before setting jumpers.



2.1.2 Jumper List

Table 2.1: Jumper List

JUMPER1	GPIO power select
J2	AT & ATX mode select
SW1	Boot select
CN18	COM0 RS232 and debug mode select
CN26	COM3 RS232 and RS485 mode detect
JSETCOM1	UART3 RS232, RS422, RS485 signal select
J422T1	COM3 RS-422 impedance select
J485T1	COM3 RS-485 impedance select
CN4	CAN impedance select
CN9	COM5 Power select
CN10	UART4 signal select to COM4 or M.2
CN21, CN25	LVDS backlight power
CN20	LVDS Power

2.1.3 Jumper Settings

JUMPER1	GPIO power select
Part number	1653003101
Footprint	HD_3x1P_79_D
Description	PIN HEADER 3x1P 2.0mm 180D(M) DIP 2000-13 WS
Setting	Function
(1-2)	+5V for GPIO level
(2-3)	+3.3V for GPIO level (default)

This pin header is designed for selecting GPIO Power level.



J2	AT & ATX mode select
Part number	1653003101
Footprint	HD_3x1P_79_D
Description	PIN HEADER 3x1P 2.0mm 180D(M) DIP 2000-13 WS
Setting	Function
(1-2)	AT mode (default)
(2-3)	ATX mode

This pin header is designed for selecting AT&ATX mode.



SW1	Boot select
Part Number	1600000202
Footprint	SW_2x2P_50_161X315
Description	DIP SW CHS-02TB(29) SMD 4P SPST P=1.27mm W=5.4mm
Setting	Function
(1-0)	ADV loader Boot from SPI NOR Flash (default)
(0-1)	ADV loader Boot from SD

This switch is designed for selecting ADV loader boot up mode, for debugging.

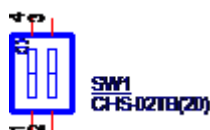

CN18	COM0 RS232 and debug mode select
-------------	---

Part Number	1653003101
Footprint	HD_3x1P_79_D
Description	PIN HEADER 3x1P 2.0mm 180D(M) DIP 2000-13 WS
Setting	function
(1-2)	COM0 is debug port (default)
(2-3)	COM0 is RS232 COM port

This pin header is designed for selecting COM0 mode, debug mode,RS232 mode



CN26	COM3 RS232 and RS485mode detect
Part Number	1653003101
Footprint	HD_3x1P_79_D
Description	PIN HEADER 3x1P 2.0mm 180D(M) DIP 2000-13 WS
Setting	function
(1-2)	RS232 mode (default)
(2-3)	RS485 mode

This pin header is designed for selecting COM3 RS232 and RS485 modes.



JSETCCOM1	UART3 RS232, RS422, RS485 signal select
Part number	1653009260
Footprint	HD_9x2P_79
Description	PIN HEADER 9x2P 2.0mm 180D(M) SMD 21N22050
Setting	Function
(5-6 7-9 8-10 13-15 14-16)	RS232 mode (CN26 must be set RS232 at the same time) (default)
(3-4 9-11 10-12 15-17 16-18)	RS422 mode
(1-2 9-11 10-12 15-17 16-18)	RS485 mode (CN26 must be set RS485 at the same time)

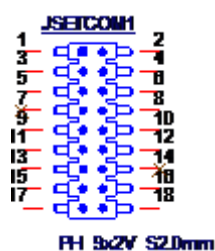
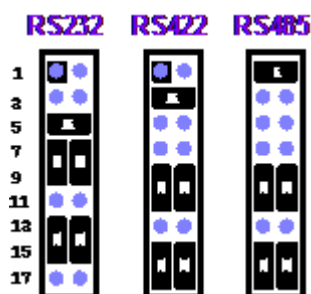

J422T1	COM3 RS-422 impedance select
Part Number	1653003201-01
Footprint	HD_3x2P_79_D_PRX
Description	PIN HEADER 2X3P 2.00mm 180D(M) DIP 1140-010-06SN
Setting	Function
(1-3,2-4)	Impedance on (default)
(3-5,4-6)	Impedance off

This pin header is designed for RS232 impedance on/off.



J485t1	COM3 RS-485 impedance select
Part Number	1653003201-01
Footprint	HD_3x2P_79_D_PRX
Description	PIN HEADER 2X3P 2.00mm 180D(M) DIP 1140-010-06SN
Setting	Function
(1-3,2-4)	Impedance On (default)
(3-5,4-6)	Impedance off

This pin header is designed for RS485 impedance on/off.



CN4	CAN impedance select
Part Number	1653002101-03
Footprint	HD_2x1P_79_H236_D
Description	PIN HEADER 1X2P 2.00mm 180D(M) DIP 1140-000-02SN
Setting	Function
(1-2)	Impedance On (default)

This pin header is designed for CAN impedance on/off.



CN9	COM5 Power select
Part Number	1653003101
Footprint	HD_3x1P_79_D
Description	PIN HEADER 3x1P 2.0mm 180D(M) DIP 2000-13 WS
Setting	Function
(1-2)	+5V (default)
(2-3)	+12V

This pin header is designed for COM5 power select. COM5 can supply 5/12V power.



CN10	UART4 signal switch
Part Number	1653005661-01
Footprint	HD_6x2P_100
Description	PIN HEADER 2X6P 2.54mm 180D(M) SMD 21N22564-12M0
Setting	Function
(3-5,4-6,9-11,10-12)	UART4 switch to COM port function (default)
(1-3,2-4,7-9,8-10)	UART4 switch to M.2 module function

This pin header is designed for UART4 .

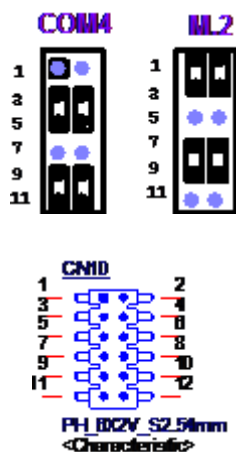

CN21,CN25	LVDS backlight power
Part Number	1653002100, 1653003100
Footprint	HD_2x1P_100_D, HD_3x1P_100_D
Description	PIN HEADER 2x1P 2.54mm 180D(M) DIP 21N12564 PIN HEADER 3x1P 2.54mm 180D(M) DIP 1130-000-03Sc
Setting	Function
CN21(1-2)	+12V
CN25(1-2)	+5V
CN25(2-3)	+3.3V (default)

This two pin header is designed for selecting LCD power levels.



CN20	LVDS Power
Part Number	1653003101
Footprint	HD_3x1P_79_D
Description	PIN HEADER 3x1P 2.0mm 180D(M) DIP 2000-13 WS
Setting	Function
CN20(1-2)	+5V
CN20(2-3)	+3.3V (default)

This pin header is designed for selecting LCD backlight power level.

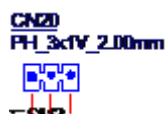

2.2 Connectors

2.2.1 Connector List

BH1	RTC battery
CN5	Mini PCIE
CN13	M.2
CN7	GPIO(0~19) port
CN17	UART1 Debug port / RS232
COM2	UART2 COM port
COM3	UART3 COM port Pin Connector
COM1	UART4 &UART5 COM port Pin Connector
CN6	CAN Connector
CN14	SATA
CN15	SATA POWER
CN19	I2C1
CN24	I2C2
CN16	I2C3
CN28B & CN28C	USB Type A Connector
CN29	USB Type A Connector
CN11	JTAG Connector
CN28A	Ethernet Connector
CN33	SD Card Slot
LVDS1	LVDS CONN
CN22	LVDS Backlight
DCIN1	DC-Power Jack
CN27	DC-IN
CN1	Reset and power button
CN3	8051 RESET# Button
AMP1	Amplifier connector
CN30	Audio & Mic Connector
CN32	SIM Card Slot
CN31	VGA display interface
HDMI1	HDMI display interface

2.2.2 Connector Settings

2.2.2.1 RTC Battery Connector (BH1)

RSB-6410 supports a lithium 3V/195mAH CR2032 battery with battery holder.



2.2.2.2 MiniPCle (CN5)

RSB-6410 supports the mini-pcie interface. The detailed pin definition is below.

Pin	Signal Name	Pin	Signal Name
1	NC	2	+3.3V_PCle
3	NC	4	GND
5	NC	6	+1.5V_PCle
7	+3.3V_PCle	8	UIM_PWR
9	GND	10	UIM_DATA
11	NC	12	UIM_CLK
13	NC	14	UIM_RESET
15	GND	16	NC
17	NC	18	GND
19	NC	20	W_DISABLE#
21	GND	22	PCIE_DIS_B
23	NC	24	+3.3V_PCle
25	NC	26	GND
27	GND	28	+1.5V_PCle
29	GND	30	I2C1_SCL_3V3
31	NC	32	I2C1_SDA_3V3
33	NC	34	GND
35	GND	36	USB_P7L_N
37	GND	38	USB_P7L_P
39	+3.3V_PCle	40	GND
41	+3.3V_PCle	42	LED_WWAN#
43	GND	44	LED_WLAN#
45	NC	46	LED_WPAN#
47	NC	48	+1.5V_PCle
49	NC	50	GND
51	NC	52	+3.3V_PCle

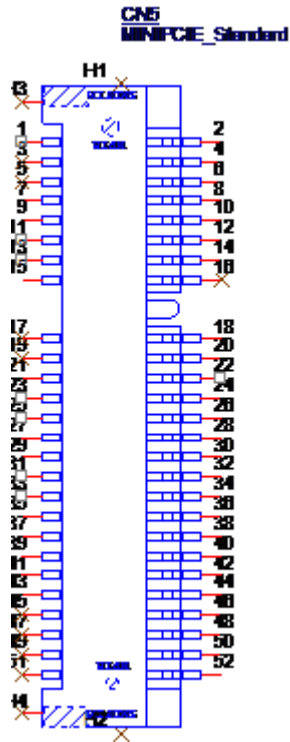

miniPCIE Connector

2.2.2.3 M.2 (CN13)

RSB-6410 supports socket1 connectivity type 2230 S1&S2&S3 key E M.2 interface. The detailed pin definition is below.

Pin	Signal Name	Pin	Signal Name
1	GND	2	+3.3V_M2
3	USB_P8L_P	4	+3.3V_M2
5	USB_P8L_N	6	WLAN_LED
7	GND	8	NC
9	M2_SD1_CLK	10	NC
11	M2_SD1_CMD	12	NC
13	M2_SD1_DAT0	14	NC
15	M2_SD1_DAT1	16	BT_LED
17	M2_SD1_DAT2	18	GND
19	M2_SD1_DAT3	20	NC
21	M2_SDIO_WAKE#	22	UART4_TXD_1V8
23	M2_SDIO_B_RST		
Mechanical Key	Mechanical Key	Mechanical Key	Mechanical Key
	NC	32	UART4_RXD_1V8
33	GND	34	UART4_RTS_1V8
35	NC	36	UART4_CTS_1V8
37	NC	38	NC
39	GND	40	NC
41	NC	42	NFC_WI_IN
43	NC	44	NC
45	GND	46	NC

47	NC	48	NC
49	NC	50	SUS_CLK
51	GND	52	NC
53	NC	54	W_DISABLE2#
55	NC	56	W_DISABLE1#
57	GND	58	NC
59	NC	60	NC
61	NC	62	NC
63	GND	64	NC
65	NC	66	NC
67	NC	68	NC
69	GND	70	NC
71	NC	72	GND
73	NC	74	GND
75	GND		

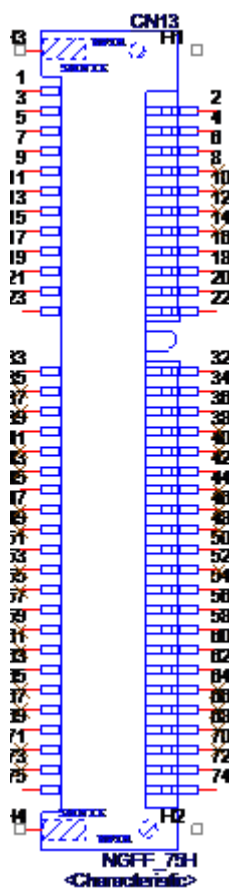

M.2 CONNECTOR

2.2.2.4 GPIO Pin Connector (CN7)

RSB-6410 provides a 11 x 2-pin connector for GPIO (supports 3.3V level & 5V level/
+V_GPIO)

Pin	Description
1	GPIO0
2	GPIO10
3	GPIO1
4	GPIO11
5	GPIO2
6	GPIO12
7	GPIO3
8	GPIO13
9	GPIO4
10	GPIO14
11	GPIO5
12	GPIO15
13	GPIO6
14	GPIO16
15	GPIO7
16	GPIO17
17	GPIO8
18	GPIO18
19	GPIO9
20	GPIO19
21	+V_GPIO
22	GND

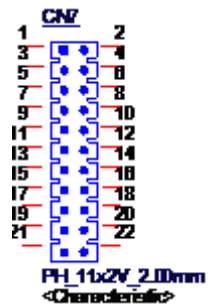

GPIO pin header

2.2.2.5 UART1 debug port (CN17)

RSB-6410 can communicate with a host server (Windows or Linux) by using debug cable (Advantech number: 1700021565-11).

Pin	Description
1	NC
2	COM0_TX
3	COM0_RX
4	GND

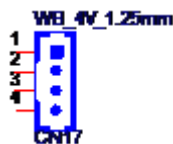

COM port

2.2.3 UART2 COM port (COM2)

RSB-6410 provides a standard DB9 connector supporting four-wire RS232.

Pin	Description
1	NC
2	COM2_RX
3	COM2_TX
4	NC
5	GND
6	NC
7	COM2_RTS
8	COM2_CTS
9	NC

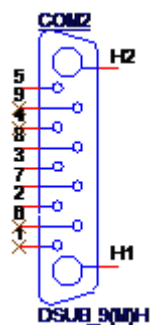

COM port

2.2.3.1 UART3 COM port (COM3)

RSB-6410 provides a standard DB9. It can support RS232/RS422/RS485 by changing jumper CN26 and JSETCOM1.

Pin	Description
1	COM3_DCD/RS485 D-
2	COM3_RX/RS485 D+
3	COM3_TX
4	COM3_DTR
5	GND
6	NC
7	COM3_RTS
8	COM3_CTS
9	NC

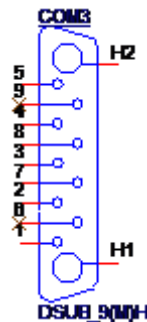

COM port pin header

2.2.3.2 UART4 and UART5 COM port Pin Connector (COM1)

RSB-6410 provides a 7 x 2-pin connectors, which contain 2 four-wire COM ports (RS232 level).

Pin	Description
1	COM4_TXD
2	COM4_RTS
3	COM4_RXD
4	COM4_CTS
5	GND
6	GND
7	COM5_RXD
8	COM5_RTS
9	COM5_TXD
10	COM5_CTS
11	GND
12	GND
13	NC
14	COM5_PWR

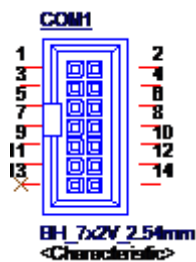

COM port pin header

2.2.3.3 CAN PORT Pin Connector (CN6)

RSB-6410 provides a 1 x 4 pin connector for CAN port.

Pin	Description
1	GND
2	CAN2_D+
3	CAN2_D-
4	GND

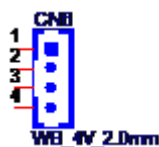

CAN port Connector

2.2.3.4 SATA PORT Pin Connector (CN14)

RSB-6410 provides one standard SATA CONN.

Pin	Description
1	GND
2	TX+
3	TX-
4	GND
5	RX-
6	RX+
7	GND

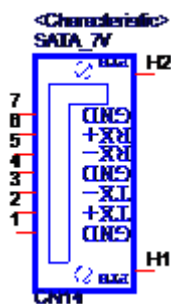

SATA port Connector

2.2.3.5 SATA Power Pin Connector (CN15)

RSB-6410 provides a 4-pin power connector for SATA devices.

Pin	Description
1	+5V
2	GND
3	GND
4	+12V

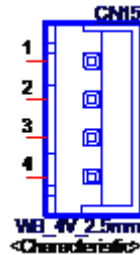

SATA Power Connector

2.2.3.6 I2C1 Pin Connector (CN19)

RSB-6410 provides a 5-pin wafer box power connector for I2C interface.

Pin	Description
1	+3.3V
2	I2C1_SCL
3	I2C1_SDA
4	Touch_INT1#
5	GND

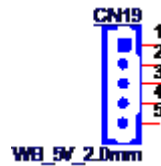

I2C1 Connector

2.2.3.7 I2C2 Pin Connector (CN24)

RSB-6410 provides a 5-pin wafer box connector for I2C2 interface.

Pin	Description
1	+3.3V
2	I2C2_SCL
3	I2C2_SDA
4	Touch_INT2#
5	GND



I2C2 Connector

2.2.3.8 I2C3 Pin Connector (CN16)

RSB-6410 provides a 5-pin wafer box connector for I2C3 interface.

Pin	Description
1	+3.3V
2	I2C3_SCL
3	I2C3_SDA
4	Touch_INT3#
5	GND

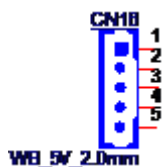

I2C3 Connector

2.2.3.9 USB Type A Connector (CN28)

RSB-6410 supports two USB2.0 Type A connectors in the coastline via CN28.

Pin	Description
15	+5V_USB_P56_B
16	USB_P6L_N
17	USB_P6L_P
18	USBV56_GND
19	+5V_USB_P56_B
20	USB_P5L_N
21	USB_P5L_P
22	USBV56_GND

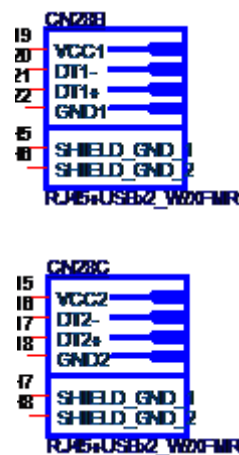

USB port connector

2.2.3.10 USB Type A Connector (CN29)

RSB-6410 supports six USB 2.0 Type A connector in the coastline via CN29.

Pin	Description
A1	+5V_USB_P12_B
A2	USB_P1L_N
A3	USB_P2L_P
A4	USB_12_GND
B1	+5V_USB_P12_B
B2	USB_P2L_N
B3	USB_P2L_P
B4	USB_12_GND
C1	+5V_USB_P34_B
C2	USB_P3L_N
C3	USB_P3L_P
C4	USB_34_GND
D1	+5V_USB_P34_B
D2	USB_P4L_N
D3	USB_P4L_P
D4	USB_34_GND

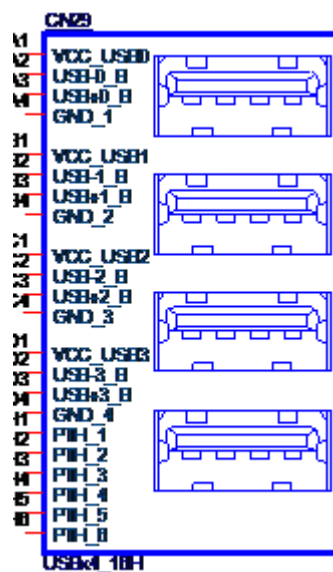

USB port connector

2.2.3.11 JTAG (CN11)

JTAG connector is used for internal debugging only.

Pin	Description
1	+3.3V
2	GND
3	JTAG_TCK_R
4	NC
5	JTAG_TMS
6	NC
7	JTAG_TDI
8	JTAG_nTRST#
9	JTAG_TDO
10	NC

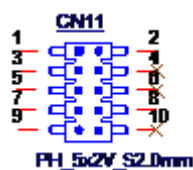

JTAG Pin header

2.2.3.12 Ethernet Connector (CN28)

RSB-6410 provides one RJ45 LAN interface connector, which is compliant with 1000 base-T IEEE 802.ab, 100 base-TX IEEE 802.u, 10 base-t IEEE 802.3. The Ethernet ports provide standard RJ-45 jack connector with LED indicators on the front side to show active/link status and speed status.

Pin	Description
1	NC
2	GBE_MDI0_P
3	GBE_MDI0_N
4	GBE_MDI1_P
5	GBE_MDI1_N
6	GBE_MDI2_P
7	GBE_MDI2_N
8	GBE_MDI3_P
9	GBE_MDI3_N
10	GND
11	LAN1_ACT
12	+3.3V
13	LAN1_1000_LINK
14	LAN1_100_LINK

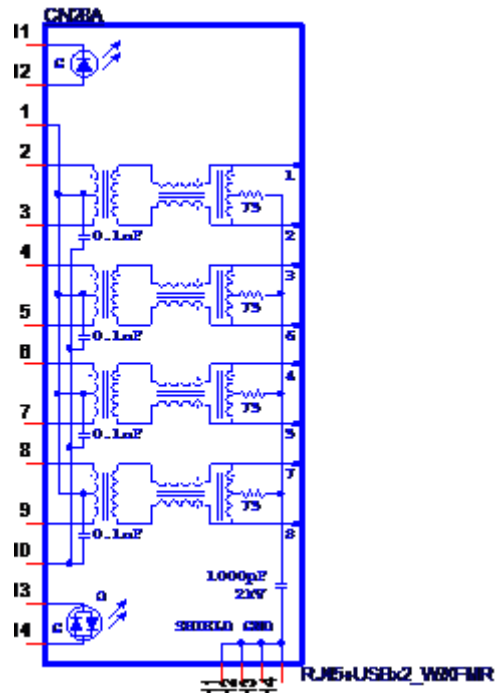

Ethernet Connector

2.2.3.13 SD slot (CN33)

RSB-6410 based on TI AM335X datasheet complies with SD & SDIO specifications 2.0. Advantech used 4G SD for the DQA test (SDHC).

Pin	Signal Name
1	SD2_DATA3
2	SD2_CMD
3	GND
4	+3.3V_SDIO
5	SD2_CLK
6	GND
7	SD2_DATA0
8	SD2_DATA1
9	SD2_DATA2
CD	SD2_CD
WP	SD2_WP
SC	GND
G	GND

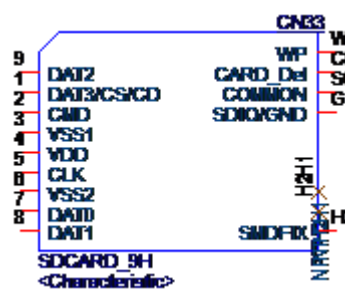

SD Slot

2.2.3.14 LVDS Connector (LVDS1)

RSB-6410 provides an LVDS 20 x 2-pin board-to-board connector for two port single channel 24-bit LVDS or one port dual channel 24-bit LVDS. To avoid to damaging the LCD panel, please make sure set the right voltage level before powering on while connecting an LVDS panel (refer to jumper setting description for CN5 and CN21 and LCD datasheet that you will use).

Pin	Description
1	VDD_LVDS
2	VDD_LVDS
3	GND
4	GND
5	VDD_LVDS
6	VDD_LVDS
7	LVDS0_TX0_N
8	LVDS1_TX0_N
9	LVDS0_TX0_P
10	LVDS1_TX0_P
11	GND

12	GND
13	LVDS0_TX1_N
14	LVDS1_TX1_N
15	LVDS0_TX1_P
16	LVDS1_TX1_P
17	GND
18	GND
19	LVDS0_TX2_N
20	LVDS1_TX2_N
21	LVDS0_TX2_P
22	LVDS1_TX2_P
23	GND
24	GND
25	LVDS0_CLK_N
26	LVDS1_CLK_N
27	LVDS0_CLK_P
28	LVDS1_CLK_P
29	GND
30	GND
31	LVDS0_EDID_SCL
32	LVDS0_EDID_SDA
33	GND
34	GND
35	LVDS0_TX3_N
36	LVDS1_TX3_N
37	LVDS0_TX3_P
38	LVDS1_TX3_P
39	HPLG
40	+3.3V

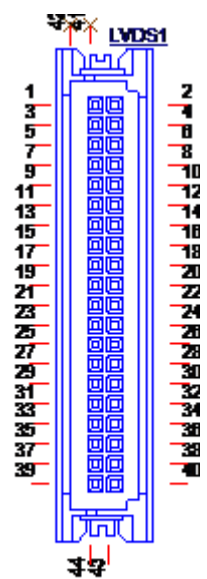

BE_20x21_S1.25mm

LVDS Connector

2.2.3.15 LVDS Inverter Power Connector (CN22)

To avoid damaging the LCD panel, please make sure to set the right voltage level before powering on while connecting an LVDS panel (refer to jumper setting description for CN2 and the LCD datasheet that you will use).

Pin	Description
1	+VDD_BKLT
2	GND
3	LVDS_BLEN
4	LVDS_CONTRAST
5	+V5

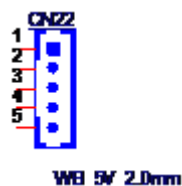

LVDS Inverter Power Connector

2.2.3.16 DC Jack (DCIN1)

RSB-6410 supports a DC-Jack that can be connected to a 12V DC external power input.

Pin	Description
1	+DC_IN
2	PGND

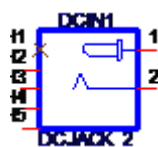

DC Jack

2.2.3.17 DC-IN (CN27)

RSB-6410 supports ATX PWR CONN. 2x2P for external power input.

Pin	Description
1	PGND
2	PGND
3	+DC_IN
4	+DC_IN

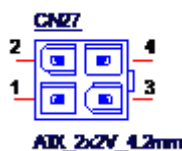

POWER CONN.

2.2.3.18 Power button and reset button (CN1)

RSB-6410 supports power button and reset button via CN1 through front cable panel attachment.

Pin	Description
2-5	Power led
3-6	Power button
9-12	Reset button

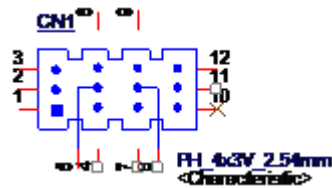

2.2.3.19 Reset Button (CN3)

RSB-6410 supports reset button by CN3 through front cable panel attachment.

Pin	Description
1	Reset#
2	GND



2.2.3.20 Amplifier Connector (AMP1)

RSB-6410 supports 6W Amplifier.

Pin	Description
1	AMP_R-
2	AMP_R+
3	AMP_L+
4	AMP_L-

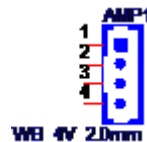

2.2.3.21 Audio & Mic Connector (CN30)

RSB-6410 supports 1 Line out and 1 Mic.in.

Pin	Description
1	GND
2	MIC
3	NC
4	NC
5	NV
22	HPOUT_L
23	ILINEOUT_DETECT
24	GND
25	HPOUT_R

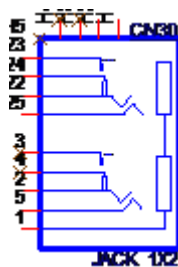

2.2.3.22 SIM Card Slot (CN32)

RSB-6410 reserves a SIM slot for 3G/4G module support.

Pin	Description
C1	UIM_VCC
C2	UIM_RESET1
C3	UIM_CLK_R
C5	GND
C6	NC
C7	UIM_DATA
SW1	NC
SW2	NC

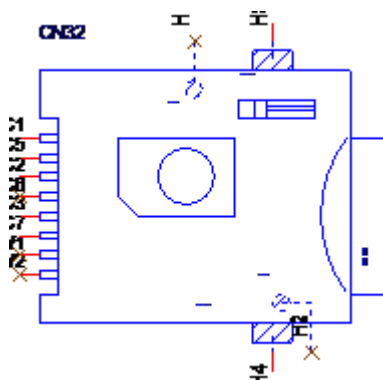

2.2.3.23 VGA Display Interface (CN31)

RSB-6410 supports VGA.

Pin	Description	Pin	Description
1	VGA_b_R	9	+5V_CRT
2	VGA_b_G	10	GND
3	VGA_b_B	11	NC
4	NC	12	VGA_b_DDC_DAT
5	GND	13	VGA_b_HSYNC
6	GND	14	VGA_b_VSYNC
7	GND	15	VGA_b_DDC_CLK
8	GND		

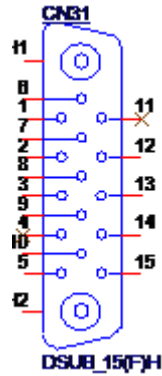

2.2.3.24 HDMI Display Interface (HDMI1)

RSB-6410 supports HDMI.

Pin	Description	Pin	Description
1	HDMI_Z_TD2_P	11	GND
2	GND	12	HDMI_Z_CLK_N
3	HDMI_Z_TD2_N	13	HDMI_CEC_OUT
4	HDMI_Z_TD1_P	14	NC
5	GND	15	HDMI_DDC_CLK
6	HDMI_Z_TD1_N	16	HDMI_DDC_DAT
7	HDMI_Z_TD0_P	17	GND
8	GND	18	+5V_HDMI
9	HDMI_Z_TD0_N	19	HDMI_HPD_OUT
10	HDMI_Z_CLK_P		

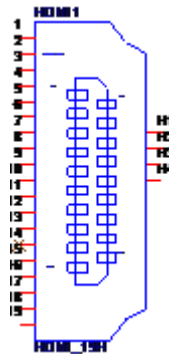

2.3 LED

Name	Description
D75	ATX_LED
D3	PCIE Mini Card LED_WPAN#
D4	PCIE Mini Card LED_WLAN#
D5	PCIE Mini Card LED_WWAN#

2.4 Mechanical

2.4.1 Jumper and Connector Locations

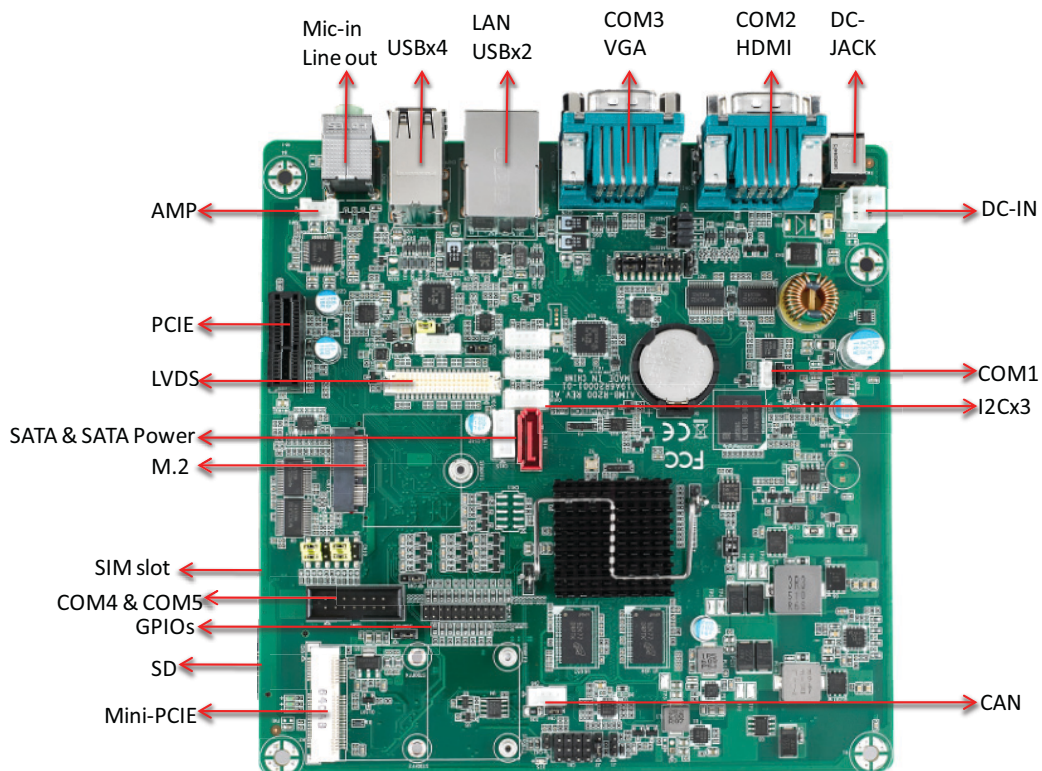

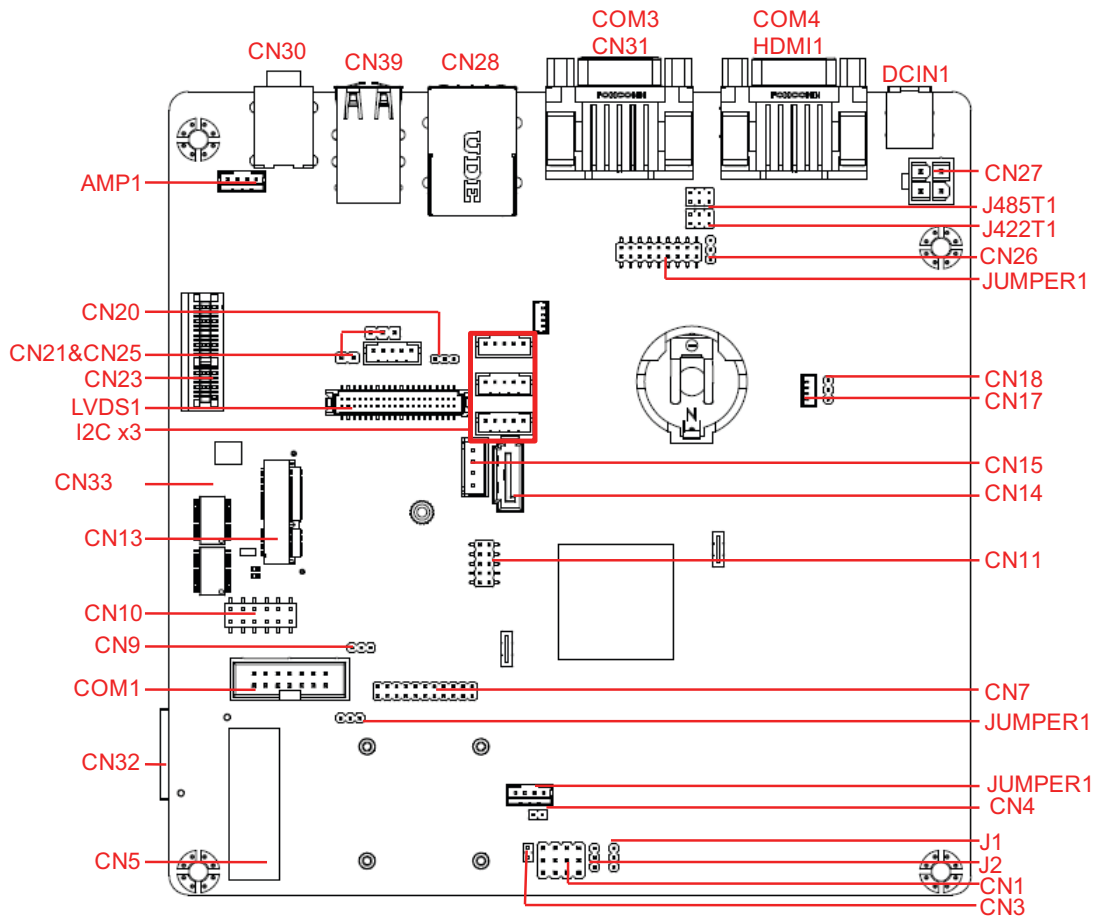

2.4.2 Board Dimensions

2.4.2.1 Board Drawing

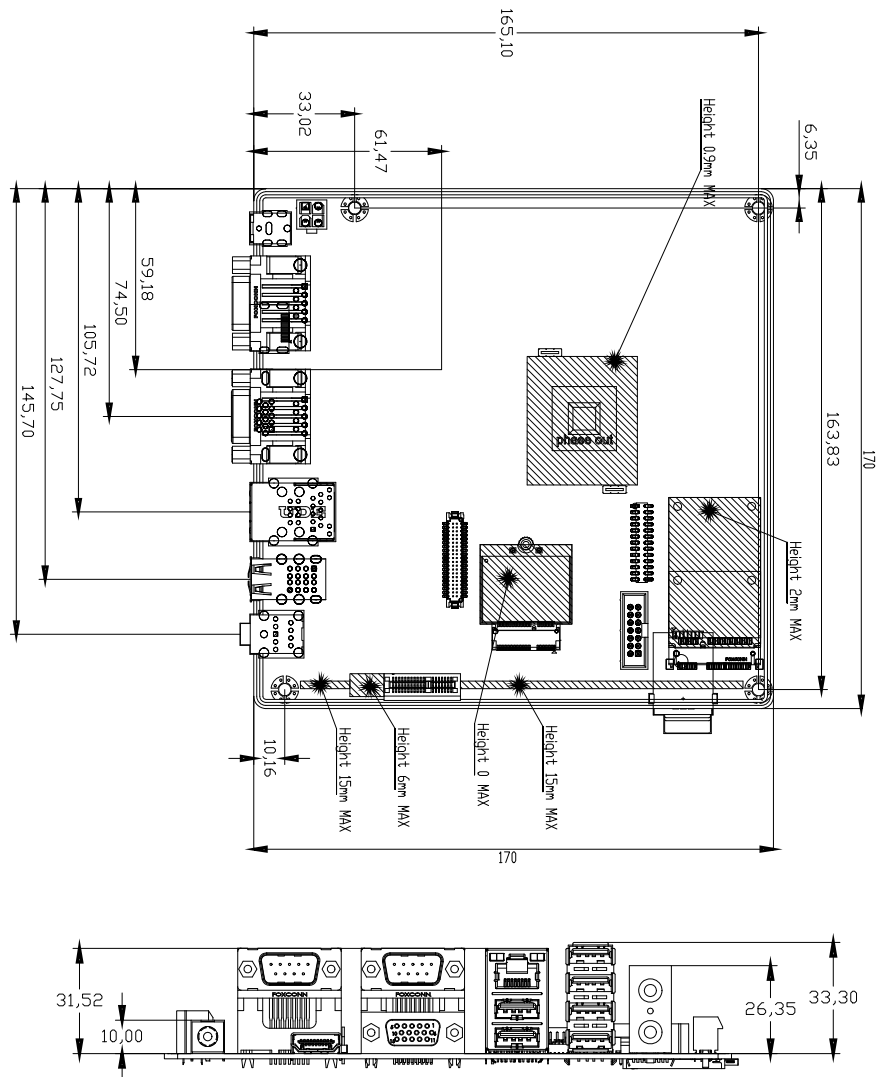

2.5 Quick Start of RSB-6410

2.5.1 Debug Port Connection

1. Connect the debug cable to RSB-6410 debug port.
2. Connect the other side of the debug cable to USB-to-RS-232 cable then connect to your PC.

2.5.2 Debug Port setting

RSB-6410 can communicate with a host server by using serial cables. Common serial communication programs such as HyperTerminal, Tera Term or PuTTY can be used in this case. The example as below describes the serial terminal setup using HyperTerminal on a Windows host:

1. Connect RSB-6410 with your PC by using a serial cable.
2. Open Hyper Terminal on your Windows PC, and select the settings as shown in Figure 2.1.
3. After the bootloader is programmed on the SD card, insert the power adapter connector to the DC jack on RSB-6410 to power up the board. The bootloader prompt is displayed on the terminal screen.

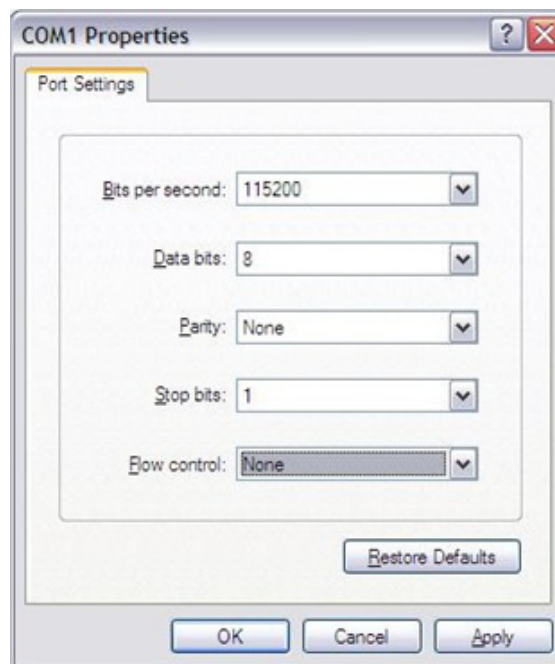

Figure 2.1 Hyper Terminal Settings for Terminal Setup

Chapter 3

Software Functionality

This chapter details the software programs on the RSB-6410 platform.

3.1 Test Tools

All test tools must be verified on RSB-6410 Evaluation kit, please prepare the required test fixtures before verifying each specified I/O. If you have any problem to get the test fixture, please contact your Advantech contact window for help.

3.2 eMMC Test

1. When booting from SD, Erase and check

```
# busybox dd if=/dev/zero of=/dev/block/mmcblk0 bs=1024 count=1 seek=1
1+0 records in
1+0 records out

# busybox hexdump -C /dev/block/mmcblk0 -s 1024 -n 16
00000400 00 00 00 00 00 00 00 00 00 00 00 00 00 00 00 00 |.....|
```

2. Write and check

```
# echo -n "0123456789ABCDEF" | dd of=/dev/block/mmcblk0 bs=1024 count=1
seek=1
0+1 records in
0+1 records out

# busybox hexdump -C /dev/block/mmcblk0 -s 1024 -n 16
00000400 30 31 32 33 34 35 36 37 38 39 41 42 43 44 45 46 |0123456789ABCDEF|
```

Note! Insert the SD Card, the eMMC NAND Flash is `mmcblk0`



3.3 USB Test

1. Insert USB flash disk then assure it is in RSB-6410 device list.
2. Erase and check

```
# dd if=/dev/zero of=/dev/block/sda bs=1024 count=1 seek=25118
1+0 records in
1+0 records out

# busybox hexdump -C /dev/block/sda -s 25720832 -n 16
01887800 00 00 00 00 00 00 00 00 00 00 00 00 00 00 00 00 |.....|
```

Note! This operation may damage the data stored in the USB flash disk. Please make sure there is no critical data in the USB flash disk being used for this test.



3. Write and check

```
# echo -n "0123456789ABCDEF" | dd of=/dev/block/sda bs=1024 count=1
seek=25118
0+1 records in
0+1 records out

# busybox hexdump -C /dev/block/sda -s 25720832 -n 16
01887800 30 31 32 33 34 35 36 37 38 39 41 42 43 44 45 46 |0123456789ABCDEF|
```

- Note!**  1. NXP i.MX6D/Q has the limitation on USB device collection, we recommend the follow brands: Logitech K120 / Lenovo K5819 LXH-EKB-10YA / RAPOO 1800.Pro / Dell MS111-P / Microsoft Wired Keyboard 200 (Model:1406) and so on.
2. This operation may damage the data stored in USB flash disk. Please make sure there is no critical data in the USB flash disk being used for this test. If your U Disk size is small, the seek value needs to be small.

3.4 SD Test

1. When booting from eMMC, you will only see the below directories:

```
# ls /dev/block/mmcblk*

/dev/block/mmcblk0 /dev/block/mmcblk0boot0 /dev/block/mmcblk0boot1 /dev/block/
mmcblk0p1 /dev/block/mmcblk0p2 /dev/block/mmcblk0p3 /dev/block/mmcblk0p4 /
dev/block/mmcblk0p5 /dev/block/mmcblk0p6 /dev/block/mmcblk0p7 /dev/block/
mmcblk0p8
```

2. Insert SD card to SD card slot (SD1) and check your device again. You should be able to see more directories. /dev/block/mmcblk1 is the SD card storage (Ex. SD Card have 2 partitions).

```
# ls /dev/block/mmcblk*
/dev/block/mmcblk0 /dev/block/mmcblk0boot0 /dev/block/mmcblk0boot1 /dev/block/
mmcblk0p1 /dev/block/mmcblk0p2 /dev/block/mmcblk0p3 /dev/block/mmcblk0p4 /
dev/block/mmcblk0p5 /dev/block/mmcblk0p6 /dev/block/mmcblk0p7 /dev/block/
mmcblk0p8 /dev/block/mmcblk1 /dev/block/mmcblk1p1 /dev/block/mmcblk1p2 /dev/
block/mmcblk1p3 /dev/block/mmcblk1p4 /dev/block/mmcblk1p5 /dev/block/
mmcblk1p6 /dev/block/mmcblk1p7 /dev/block/mmcblk1p8
```

3. Erase and check

```
# dd if=/dev/zero of=/dev/block/mmcblk1 bs=1024 count=1 seek=25118
1+0 records in
1+0 records out

# busybox hexdump -C /dev/block/mmcblk1 -s 25720832 -n 16
01887800 00 00 00 00 00 00 00 00 00 00 00 00 00 00 00 |.....|
```

4. Write and check

```
# echo -n "0123456789ABCDEF" | dd of=/dev/block/mmcblk1 bs=1024 count=1
seek=25118
0+1 records in
0+1 records out

# busybox hexdump -C /dev/block/mmcblk1 -s 25720832 -n 16
01887800 30 31 32 33 34 35 36 37 38 39 41 42 43 44 45 46 |0123456789ABCDEF|
```

- Note!**  Please make sure parameter "seek" is equal to 25118 as indicated in red in above codes. If you create the file to a wrong sector, that may damage the system.

3.5 GPIO Test

RSB-6410 GPIO default setting

RSB-6410	Android OS /sys/class/gpio/	Default direction
GPIO0	gpio2	in
GPIO1	gpio3	in
GPIO2	gpio4	in
GPIO3	gpio 5	in
GPIO4	gpio6	in
GPIO5	gpio7	in
GPIO6	gpio8	in
GPIO7	gpio9	in
GPIO8	gpio10	in
GPIO9	gpio11	in
GPIO10	gpio12	out
GPIO11	gpio13	out
GPIO12	gpio14	out
GPIO13	gpio15	out
GPIO14	gpio16	out
GPIO15	gpio17	out
GPIO16	gpio18	out
GPIO17	gpio19	out
GPIO18	gpio20	out
GPIO19	gpio21	out

```
# cd /sys/class/gpio
```

You can use "ls" to list all GPIO devices, and you should also see GPIO ports in above table.

Example of testing GPIO

Set gpio2 GPI(in)

```
# echo in > ./gpio2/direction  
# cat ./gpio2/direction  
in
```

Set gpio12 GPO (out)

```
# echo out > ./gpio12/direction  
# cat ./gpio12/direction  
out
```

Set gpio12 GPO value "1"

```
# echo 1 > ./gpio12/value
```

Get gpio2 GPI value

```
# cat ./gpio2/value
1
```

As you can see in above procedure A and B, we set gpio2 as GPI and gpio12 as GPO, once we send data out from gpio12, it should be able to receive the same data from gpio2.

3.6 I2C Test

There is one I2C buses in RSB-6410.

```
# ls /sys/class/i2c-dev
i2c-0
i2c-1
i2c-2

# i2cdetect -l
i2c-0 i2c      imx-i2c      I2C adapter
i2c-1 i2c      imx-i2c      I2C adapter
i2c-2 i2c      imx-i2c      I2C adapter
```

Please try below command to know if there is any device connected to i2c bus 1.

```
# i2cdetect -yr 2
 0 1 2 3 4 5 6 7 8 9 a b c d e f
00:  -----
10:  -----
20:  ----- 29 -----
30:  ----- 37 -----
40:  ----- 49 -----
50: UU 51 52 53 54 55 56 57 -- 59 -----
60:  -----
70:  ----- UU --
```

The 0x29 is the 8051 address. So you can try the below command to know of the I2C bus is working or not.

```
# i2cdump -yf 2 0x29
No size specified (using byte-data access)
No size specified (using byte-data access)
 0 1 2 3 4 5 6 7 8 9 a b c d e f 0123456789abcdef
00: ff ff ff ff ff ff ff ff ff ff ff ff ff ff ff ff .....
10: ff ff ff ff ff 2c c8 ff ff ff ff ff ff ff ff ff ff .....?.....
20: ff ff ff ff ff 28 c4 00 00 ff ff ff ff ff ff ff ff ff .....(?.....
30: ff ff ff ff ff ff ff ff ff ff ff ff ff ff ff ff .....
40: ff ff ff ff ff ff ff ff ff ff ff ff ff ff ff ff .....
50: ff ff ff ff ff ff ff ff ff ff ff ff ff ff ff ff .....
60: ff ff ff ff ff ff ff ff ff ff ff ff ff ff ff ff .....
70: ff ff ff ff ff ff ff ff ff ff ff ff ff ff ff ff .....
80: ff ff ff ff ff ff ff ff ff ff ff ff ff ff ff ff .....
90: ff ff ff ff ff ff ff ff ff ff ff ff ff ff ff ff .....
a0: ff ff ff ff ff ff ff ff ff ff ff ff ff ff ff ff .....
b0: ff ff ff ff ff ff ff ff ff ff ff ff ff ff ff ff .....
c0: ff ff ff ff ff ff ff ff ff ff ff ff ff ff ff ff .....
d0: ff ff ff ff ff ff ff ff ff ff ff ff ff ff ff ff .....
e0: ff ff ff ff ff ff ff ff ff ff ff ff ff ff ff ff .....
f0: ff ff ff ff ff ff ff ff ff ff ff ff ff ff ff ff .....
```

3.7 LAN Test

RSB-6410 sets DHCP as the default network protocol.

```
# busybox ifconfig -a
can0    Link encap:UNSPEC HWaddr 00-00-00-00-00-00-00-00-00-00-00-00-00-00-00-00
        UP RUNNING NOARP MTU:16 Metric:1
        RX packets:0 errors:0 dropped:0 overruns:0 frame:0
        TX packets:0 errors:0 dropped:0 overruns:0 carrier:0
        collisions:0 txqueuelen:10
        RX bytes:0 (0.0 B) TX bytes:0 (0.0 B)
        Interrupt:142

eth0    Link encap:Ethernet HWaddr 00:04:9F:01:30:E0
        UP BROADCAST RUNNING MULTICAST MTU:1500 Metric:1
        RX packets:0 errors:0 dropped:0 overruns:0 frame:0
        TX packets:0 errors:0 dropped:0 overruns:0 carrier:0
        collisions:0 txqueuelen:1000
        RX bytes:0 (0.0 B) TX bytes:0 (0.0 B)

lo      Link encap:Local Loopback
        inet addr:127.0.0.1 Mask:255.0.0.0
        inet6 addr: ::1/128 Scope:Host
        UP LOOPBACK RUNNING MTU:16436 Metric:1
        RX packets:0 errors:0 dropped:0 overruns:0 frame:0
        TX packets:0 errors:0 dropped:0 overruns:0 carrier:0
        collisions:0 txqueuelen:0
        RX bytes:0 (0.0 B) TX bytes:0 (0.0 B)
```

If you would like to config IP manually, please use the below command:

```
# busybox ifconfig eth0 xxx.xxx.xxx.xxx up
```

Here is a real case for your reference. The hosts (RSB-6410) IP is 192.168.0.10; the target (A desktop computer) IP is 192.168.0.12

```
#busybox ifconfig eth0 down
# busybox ifconfig eth0 192.168.0.10 up
# busybox ifconfig eth0
eth0   Link encap:Ethernet  HWaddr 00:04:9F:01:30:E0
       inet addr:192.168.0.10  Bcast:192.168.0.255  Mask:255.255.255.0
       UP BROADCAST RUNNING MULTICAST  MTU:1500  Metric:1
       RX packets:0 errors:0 dropped:0 overruns:0 frame:0
       TX packets:0 errors:0 dropped:0 overruns:0 carrier:0
       collisions:0 txqueuelen:1000
       RX bytes:0 (0.0 B)  TX bytes:0 (0.0 B)
```

The target computer (Client) IP address is 192.168.0.12, so we can use the below command to see if we can get any response from the client.

```
# ping 192.168.0.12

PING 192.168.0.12 (192.168.0.12): 56 data bytes
64 bytes from 192.168.0.12: seq=0 ttl=128 time=7.417 ms
64 bytes from 192.168.0.12: seq=1 ttl=128 time=0.203 ms
64 bytes from 192.168.0.12: seq=2 ttl=128 time=0.300 ms

--- 172.17.20.192 ping statistics ---
3 packets transmitted, 3 packets received, 0% packet loss
```

Note! The target computer (Client) firewall need close.



3.8 UART Test

As you can see below, there are 5 UART supported by RSB-6410. /dev/ttymx0 is reserved for RSB-6410 debug port, the rest of the UART ports could be applied by the user. UART1/UART2/UART3/UART4 connect to loopback.

HW	SW	DEVICE
COM1	UART0	/dev/ttymx0
COM2	UART1	/dev/ttymx1
COM3	UART2	/dev/ttymx2
COM4	UART3	/dev/ttymx3
COM5	UART4	/dev/ttymx4

Test RSB232

```
# AutoRun_uart232

=====test rs232!=====
rs232 number: 5
/dev/ttymx1 PASS!
/dev/ttymx2 PASS!
/dev/ttymx3 PASS!
/dev/ttymx4 PASS !

+-----+
| [RS232] Test Pass!|
+-----+
```

Note! *Only UART2 supports RSB232/RSB422/RSB485, test rsb232 mode, please jump rsb232 mode, you can refer to detailed jump information from the 2.1.2 Jumper List.*



UART2 Test RSB422

```
# AutoRun_uart422 -p /dev/ttymx2 -t 1 -s 115200
=====test RS422=====
Open uart /dev/ttymx2 PASS ....

->Writing : hello world!
->Reading : hello world!
->TX/RX Signal pass

+-----+
| UART RS422 Testing PASS |
+-----+
```

Note! *UART2 Jump RSB422 mode and Connect to loopback, you can refer to detailed jumper information in the 2.1.2 Jumper List.*



UART2 Test RS485

RSB-6410 only support one RS485 port, please find another device that supports RS485 port and connect to COM3 using the Serial Port Tool from 4.8 Serial Port Test.

Note! *COM3 Jump RS485 mode, you can refer to detailed jumper information in the 2.1.2 Jumper List.*



3.9 Can Test

1. Prepare one Advantech PCI-1680U Can card and install the driver.
2. Connect RSB-6410 CAN port CAN1_D+ /CAN1_D- and GND with Advantech PCI-1680U Can card.

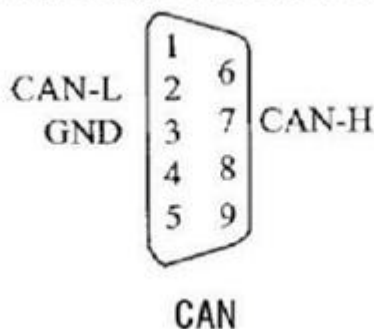

3. Use the follow command under RSB-6410 to send data through to the Can card.

```
# cansend can0 0x01 0x02 0x03
interface = can0, family = 29, type = 3, proto = 1
```

4. Use the following command under RSB-6410 to receive data form the opposite side:

```
# candump
interface = can0, family = 29, type = 3, proto = 1
```

3.10 Display Output Setting

Please set environment in u-boot as below

3.10.1 Single Display Settings

1. HDMI out, please set in u-boot as below:

```
setenv bootargs console=ttyMXC0,115200 androidboot.console=ttyMXC0
vmalloc=400M init=/init video_mode=extension
video=mxcb0:dev=hdmi,1920x1080M@60,bpp=32 video=mxcb1:off
video=mxcb2:off video=mxcb3:off fbmem=28M,28M
androidboot.hardware=freescale pcie_testmode=off
```
2. VGA out, please set in u-boot as below:

```
setenv bootargs console=ttyMXC0,115200 androidboot.console=ttyMXC0
vmalloc=400M init=/init video_mode=extension
video=mxcb0:dev=lcd,1920x1080M@60,bpp=32 video=mxcb1:off
video=mxcb2:off video=mxcb3:off fbmem=28M,28M
androidboot.hardware=freescale pcie_testmode=off
```
3. LVDS (Single Channel 7inch) out, please set in u-boot as below:

```
setenv bootargs console=ttyMXC0,115200 androidboot.console=ttyMXC0
vmalloc=400M init=/init video_mode=displayLSC
video=mxcb0:dev=lcd,LDB-800X480,if=RGB666 bpp=24 ldb=sin0
video=mxcb1:off video=mxcb2:off video=mxcb3:off fbmem=28M,28M
androidboot.hardware=freescale pcie_testmode=off
```

4. LVDS (Single Channel 15inch) out, please set in u-boot as below:

```
setenv bootargs console=ttyMXC0,115200 androidboot.console=ttyMXC0
vmalloc=400M init=/init video_mode=displayLSC
video=mxcfb0:dev=ldb,LDB-1024X768,if=RGB24 bpp=32 ldb=sin0
video=mxcfb1:off video=mxcfb2:off video=mxcfb3:off fbmem=28M,28M
androidboot.hardware=freescale pcie_testmode=off
```
5. LVDS (Dual Channel 21inch) out, please set in u-boot as below:

```
setenv bootargs console=ttyMXC0,115200 androidboot.console=ttyMXC0
vmalloc=400M init=/init video_mode=displayLDC
video=mxcfb0:dev=ldb,LDB-1080P60,if=RGB24 bpp=32 ldb=spl0
video=mxcfb1:off video=mxcfb2:off video=mxcfb3:off fbmem=28M,28M
androidboot.hardware=freescale pcie_testmode=off
```

3.10.2 Dual Display Settings

When you want to display dual LVDS, VGA and HDMI output , please set parameter in U-boot as follows. This is the default setting in U-boot.

1. HDMI and VGA clone out, please set in u-boot as below:

```
setenv bootargs console=ttyMXC0,115200 androidboot.console=ttyMXC0
vmalloc=400M init=/init video_mode=extension
video=mxcfb0:dev=lcd,1920x1080M@60,bpp=32
video=mxcfb1:dev=hdmi,1920x1080M@60,bpp=32 video=mxcfb2:off
video=mxcfb3:off fbmem=28M,28M
androidboot.hardware=freescale pcie_testmode=off
```

Note! *This is the default setting.*



2. LVDS (Single Channel 15inch * 2pieces) clone out, please set in u-boot as below:

```
setenv bootargs console=ttyMXC0,115200 androidboot.console=ttyMXC0
vmalloc=400M init=/init video_mode=displayLSCC
video=mxcfb0:dev=ldb,LDB-1024X768,if=RGB24 bpp=32 ldb=sep0
video=mxcfb1:dev=ldb,LDB-1024X768,if=RGB24 bpp=32 ldb=sep1
video=mxcfb2:off video=mxcfb3:off fbmem=28M,28M
androidboot.hardware=freescale pcie_testmode=off
```
3. LVDS (Single Channel 15inch) and VGA clone out, please set in u-boot as below:

```
setenv bootargs console=ttyMXC0,115200 androidboot.console=ttyMXC0
vmalloc=400M init=/init video_mode=displayLSCV
video=mxcfb0:dev=ldb,LDB-1024X768,if=RGB24 bpp=32 ldb=sin0
video=mxcfb1:dev=lcd,1920x1080M@60,bpp=32 video=mxcfb2:off
video=mxcfb3:off fbmem=28M,28M
androidboot.hardware=freescale pcie_testmode=off
```
4. LVDS (Single Channel 15inch) and HDMI clone out, please set in u-boot as below:

```
setenv bootargs console=ttyMXC0,115200 androidboot.console=ttyMXC0
vmalloc=400M init=/init video_mode=extension
video=mxcfb0:dev=ldb,LDB-1024X768,if=RGB24,bpp=32 ldb=sin0
video=mxcfb1:dev=hdmi,1920x1080M@60,bpp=32 video=mxcfb2:off
video=mxcfb3:off fbmem=28M,28M
androidboot.hardware=freescale pcie_testmode=off
```

5. LVDS (Dual Channel 21inch) and VGA clone out, please set in u-boot as below:

```
setenv bootargs console=ttymxc0,115200 androidboot.console=ttymxc0
vmalloc=400M init=/init video_mode=extension
video=mxcfb0:dev=ldb,LDB-1080P60,if=RGB24,bpp=32 ldb=spl0
video=mxcfb1:dev=ldb,1920x1080M@60,bpp=32 video=mxcfb2:off
video=mxcfb3:off fbmem=28M,28M
androidboot.hardware=freescale pcie_testmode=off
```
6. LVDS (Dual Channel 21inch) and HDMI clone out, please set in u-boot as below:

```
setenv bootargs console=ttymxc0,115200 androidboot.console=ttymxc0
vmalloc=400M init=/init video_mode=displayLDCH
video=mxcfb0:dev=ldb,LDB-1080P60,if=RGB24,bpp=32 ldb=spl0
video=mxcfb1:dev=hdmi,1920x1080M@60,bpp=32 video=mxcfb2:off
video=mxcfb3:off fbmem=28M,28M
androidboot.hardware=freescale pcie_testmode=off
```
7. LVDS (Single Channel 7inch) and HDMI clone out, please set in u-boot as below:

```
setenv bootargs console=ttymxc0,115200 androidboot.console=ttymxc0
vmalloc=400M init=/init video_mode=displayL7
video=mxcfb0:dev=ldb,LDB-800X480,if=RGB666,bpp=24
video=mxcfb1:dev=hdmi,1920x1080M@60,bpp=24 video=mxcfb2:off
video=mxcfb3:off fbmem=28M,28M
androidboot.hardware=freescale pcie_testmode=off
```

3.10.3 Triple Display Settings

1. LVDS (Single Channel 7inch), HDMI and VGA clone out, please set in u-boot as below:

```
setenv bootargs console=ttymxc0,115200 androidboot.console=ttymxc0
vmalloc=400M init=/init
video=mxcfb0:dev=ldb,LDB-800X480,if=RGB666,bpp=24
video=mxcfb1:dev=hdmi,1920x1080M@60,bpp=24 fbmem=28M,28M
androidboot.hardware=freescale pcie_testmode=off
```

Chapter 4

Android OS

This chapter introduces how to build an Android system and development based our Android system.

4.1 Introduction

The purpose of this chapter is to introduce software development of RSB-6410 to you, so that you can develop your own applications. RSB-6410 supports Linux host only so you will fail developing your AP on Windows/Android host PC. For now the official supported host version is Ubuntu 14.04 64-bit, host PCs in any other version may have compatibility issues. In this case, we strongly recommend to have Ubuntu 14.04 LTS 64-bit installed to your host PC before start RSB-6410 evaluation/development.

4.2 Board Support Package

We offer you two different kinds of Android package for RSB-6410. One is pre-built system image for system recovery another is source code package (BSP).

4.2.1 Pre-built System Image

You are able to find the pre-built image RSB-6410AIVxxxx_yyyy-mm-dd.tar.gz from RSB-6410 evaluation kit DVD image downloaded from Advantech website. RSB-6410 supports booting from SD card so you can extract the image to an SD card then dump the image file to the onboard eMMC to complete system recovery. Some folders and files are described below:

image:

This folder contains uboot image, kernel image and android root filesystem tar file and so on. These files are used to burn to sd card or nand flash.

scripts:

This folder contains scripts for flashing images easily.

`mkzd-android.sh`

To create a bootable SD card. `mkmmc-android.sh`

To burn android firmware to eMMC flash

4.2.2 Source Code Package

RSB-6410 board support package (BSP) contains cross compiler, linux kernel source code, u-boot source code, android root file system and some scripts used in OS development. Some of above components are developed by Advantech and the others are developed by open source community.

Some folders described below:

android/bootable/bootloader/uboot-imx/

U-Boot source code

android/device/fsl/rsb_6410/

Android related settings for RSB-6410

android/hardware/imx/

HAL (Hardware Abstraction Layer)

android/kernel_imx/

Android kernel source code

android/prebuilts/

Android toolchain, sdk and so on

4.3 Set up Build Environment

All instructions in this guide are based on Ubuntu 14.04 64-bit only. Please install Ubuntu 14.04 64bit with minimum 2GB DRAM in advance, login to the installed system and perform the following:

4.3.1 Installing JDK

```
root@PcName:~# sudo apt-get update
```

```
root@PcName:~# sudo apt-get install python-software-properties
```

1. Get `jdk-6u45-linux-x64.bin` from `android-source-code-directory/tools/`
2. Follow these steps to install JDK 6

```
$ chmoda+x jdk-6uXX-linux-x64.bin
$ ./jdk-6uXX-linux-x64.bin
$ sudo mkdir -p /usr/lib/jvm
$ sudo mv jdk1.6.0_XX /usr/lib/jvm/
$ sudo update-alternatives --install "/usr/bin/java" "java" "/usr/lib/jvm/jdk1.6.0_XX/bin/java" 1
$ sudo update-alternatives --install "/usr/bin/javac" "javac" "/usr/lib/jvm/jdk1.6.0_XX/bin/javac" 1
$ sudo update-alternatives --config java
$ sudo update-alternatives --config javac
```

4.3.2 Installing Required Packages

```
sudo apt-get install bison build-essential ccache curl dpkg flex gcc g++ gettext git-core gnupg gperf g++-multilib ia32-libs intltool lib1g-dev lib32ncurses5-dev lib32readline5-dev lib32z-dev libarchive-zip-perl libc6-dev libdbus-glib-1-dev libfreetype6-dev libgl1-mesa-dev libgtk2.0-dev liblzo2-2 liblzo2-dev libncurses5-dev liborbit2-dev libtool libx11-dev libxml2-utils libxml2-dev m4 mingw32 patch python-markdown rpm tcl uboot-mkimage uuid uuid-dev tofrodos x11proto-core-dev xsltproc zip zlib1g zlib1g-dev
```

4.3.3 Toolchain setup

Before building an Android system, you need setup the toolchain.

Android toolchain is under `android/prebuilts`. Please refer to 4.2.1

Setup the toolchain path to point to `arm-eabi- tools` in `android/prebuilts/gcc/linux-x86/arm/arm-eabi-4.6/bin`, the command is:

```
root@PcName:~# export
```

```
PATH=$ANDROID_DIR/android/prebuilts/gcc/linux-x86/arm/arm-eabi-4.6/bin:$PATH
```

4.4 Build Instructions

1. Open one terminal console and change directory to BSP scripts folder.
2. Perform one of the following commands:

4.4.1 Build android

1. Open a terminal console and change directory to BSP scripts folder
2. Perform the following command:
root@PcName:~# ./mk_android.sh <product name>
where <product name> is:
 - **RSB-6410** for RSB-6410 board
3. Then you can get android all image file under image folder, include as follows **u-boot_crc.bin**, **u-boot_crc.bin.crc**, **boot.img**, **system.img**, **recovery.img**.

4.4.2 Build android kernel

1. Open a terminal console and change directory to BSP scripts folder
2. Perform the following command:
root@PcName:~# ./mk_bootimg.sh <product name>
where <product name> is:
 - **RSB-6410** for RSB-6410 board
3. Then you can get the android kernel image file named boot.img under **image** folder.

4.4.3 Build android system image

1. Open a terminal console and change directory to BSP scripts folder
2. Perform the following command:
root@PcName:~# ./mk_system.sh <product name>
where <product name> is:
 - **RSB-6410** for RSB-6410 board
3. Then you can get the android kernel image file named system.img under **image** folder

4.4.4 Build android recovery image

1. Open a terminal console and change directory to BSP scripts folder
2. Perform the following command:
root@PcName:~# ./mk_recovery.sh <product name>
where <product name> is:
 - **RSB-6410** for RSB-6410 board
3. Then you can get the android kernel image file named recovery.img under **image** folder

4.4.5 Build android OTA package

1. Open a terminal console and change directory to BSP scripts folder
2. Perform the following command:
root@PcName:~# ./mk_otapackage.sh <product name>
where <product name> is:
 - **RSB-6410** for RSB-6410 board
3. Then you can get the android kernel image file named update.zip under **image** folder

4.5 Debug Console

Connect the 9-pin D-SUB of debug console cable with the host computer serial port using a serial port terminal application (like minicom, putty or teraterm) then config serial port as 115200 8N1.

Then plug in the 4-pin connector debug console cable into RSB-6410's debug port (also known as /dev/ttymx0 in Android)

4.6 Boot up from SD card or eMMC

RSB-6410 supports boot from SD card or onboard flash. This section will guide you how to build an image for RSB-6410 Android system boot media.

4.6.1 The storages devices name as following:

Device	Name
SD card	/dev/block/mmcblk1
eMMC	/dev/block/mmcblk0

4.6.2 Create a bootable SD card

You are able to find the pre-built image from Advantech website. Please follow the steps below to create an SD card for boot up.

1. Copy "RSB-6410AIVxxxx_yyyy-mm-dd.tar.gz" package to your /root/.
2. Open "Terminal" on Ubuntu 14.04 LTS..
3. **\$sudo su** (Change to "root" authority)
4. Input your password.
5. **root@PcName:~# cd /root/**
6. **root@PcName:~# tar xzvf RSB-6410AIVxxxx_yyyy-mm-dd.tar.gz** (Unzip files)
7. Insert one SD card into your development computer
8. Check the SD card location, like /dev/sdb
9. **root@PcName:~# cd ./RSB-6410AIVxxxx_yyyy-mm-dd/scripts**
10. **root@PcName:~# ./mk_sd-android.sh /dev/sdb**

Then insert the SD card to RSB-6410 and power up, it should boot up with an Android environment.

4.6.3 Transfer the whole system to onboard eMMC

1. Open a debug console
2. Boot up from the SD card
Perform the following command:
root@PcName:~# cd /data/mkimage /scripts
root@PcName:~# ./mkmmc?android.sh /dev/block/mmcblk0
3. Remove the SD card, then RSB-6410 can boot up from the onboard eMMC.

4.7 Customization

4.7.1 Config Android Kernel

1. Open a terminal console and change directory to BSP scripts folder
2. Perform the following command:
root@PcName:~# cd android/kernel_imx
root@PcName:~# make ARCH=arm menuconfig
3. Linux Kernel configuration shows up as below:

```
.config - Linux/arm 3.0.35 Kernel Configuration
Linux/arm 3.0.35 Kernel Configuration
Arrow keys navigate the menu. <Enter> selects submenus --->.
Highlighted letters are hotkeys. Pressing <Y> includes, <N> excludes,
<M> modularizes features. Press <Esc><Esc> to exit, <?> for Help, </>
for Search. Legend: [*] built-in [ ] excluded <M> module < >
[*] Patch physical to virtual translations at runtime (EXPERIMENTAL)
General setup --->
[*] Enable loadable module support --->
[*] Enable the block layer --->
System Type --->
[ ] FIQ Mode Serial Debugger
Bus support --->
Kernel Features --->
Boot options --->
CPU Power Management --->
m v(+)
```

- By menu, Device Drivers / Network device support, you can select device(s) you want to build into your Linux kernel.

```
.config - Linux/arm 3.0.35 Kernel Configuration
Network device support
Arrow keys navigate the menu. <Enter> selects submenus --->.
Highlighted letters are hotkeys. Pressing <Y> includes, <N> excludes,
<M> modularizes features. Press <Esc><Esc> to exit, <?> for Help, </>
for Search. Legend: [*] built-in [ ] excluded <M> module < >
[*] Network device support
< > Intermediate Functional Block support
< > Dummy net driver support
< > Bonding driver support
< > MAC-VLAN support (EXPERIMENTAL)
< > EQL (serial line load balancing) support
<+> Universal TUN/TAP device driver support
< > Virtual ethernet pair device
< > ARCnet support --->
<+*> Generic Media Independent Interface device support
v(+)
```

< Select > < Exit > < Help >

- Refer to section 4.4.1 to rebuild everything.

4.7.2 Put source code to system

- Put whole package directory to BSP's folder:
./android/packages/apps/
- Create a file, Android.mk, at package directory; the contents look like below:
LOCAL_PATH:= \$(call my-dir)
include \$(CLEAR_VARS)
LOCAL_MODULE_TAGS := optional
LOCAL_SRC_FILES := \$(call all-java-files-under, src)
LOCAL_PACKAGE_NAME := PROJECT_NAME_HERE
LOCAL_CERTIFICATE := platform
include \$(BUILD_PACKAGE)
Use the following include to make our test apk. include \$(call all-makefiles-under,\$(LOCAL_PATH))
- Edit following file:
./android/device/Advantech/RSB-6410/device.mk
to insert correct project name:

PRODUCT_PACKAGES += \
PROJECT_NAME_HERE\
librxtxSerial\
SerialJ

4.8 Serial Port Test

4.8.1 Setup Serial Port

1. Click on the Serial Port.

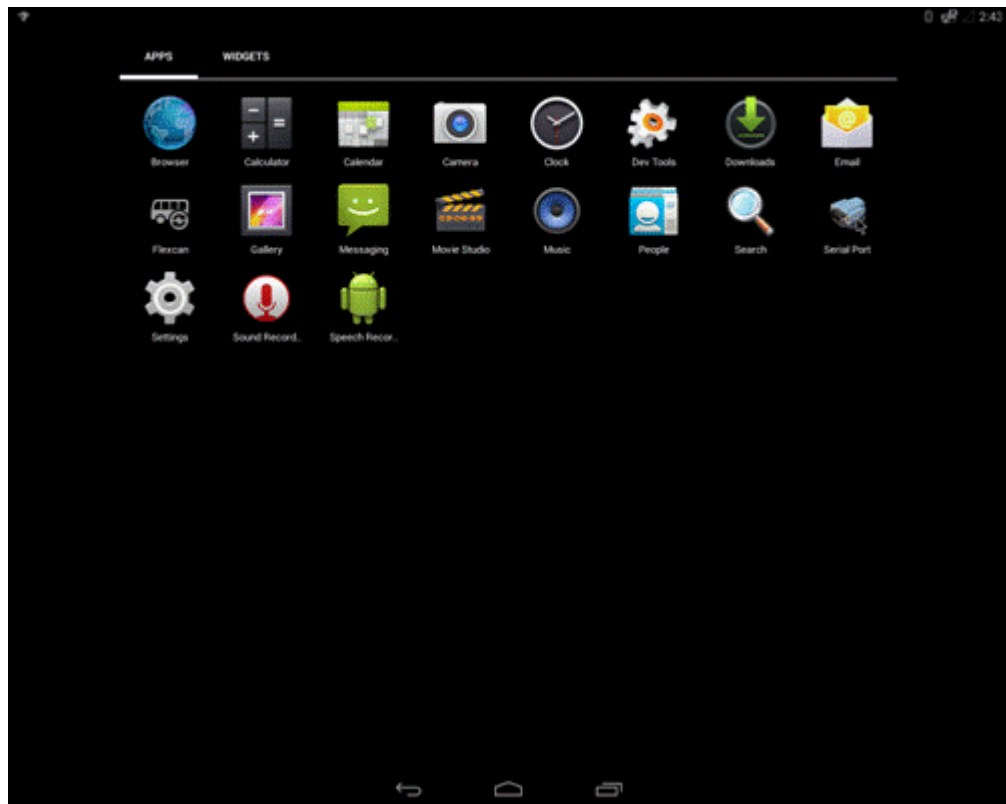

2. Click **Setup**.

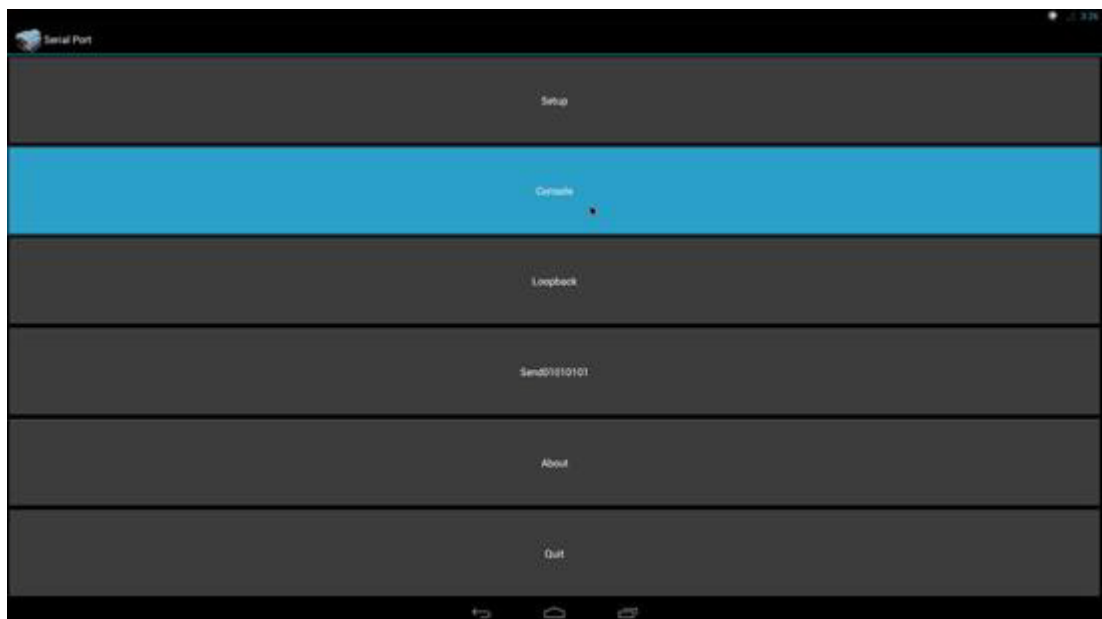

3. Click Device, and choose used device (ex. ttymxc1)

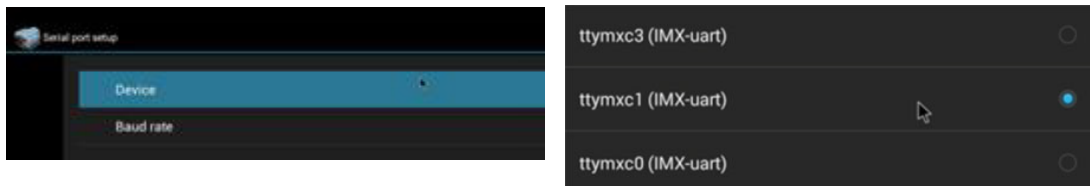

4. Click Baud rate, and choose used baudrate (ex. 115200)

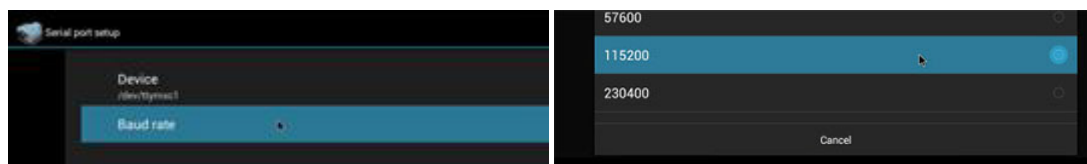

4.8.2 Console Test

1. Using serial cable to connect ttymxc1 with PC/NB's serial port that should be configured to 115200 8N1, and opening serial terminal AP (like minicom, putty or teraterm)
2. Click Console.

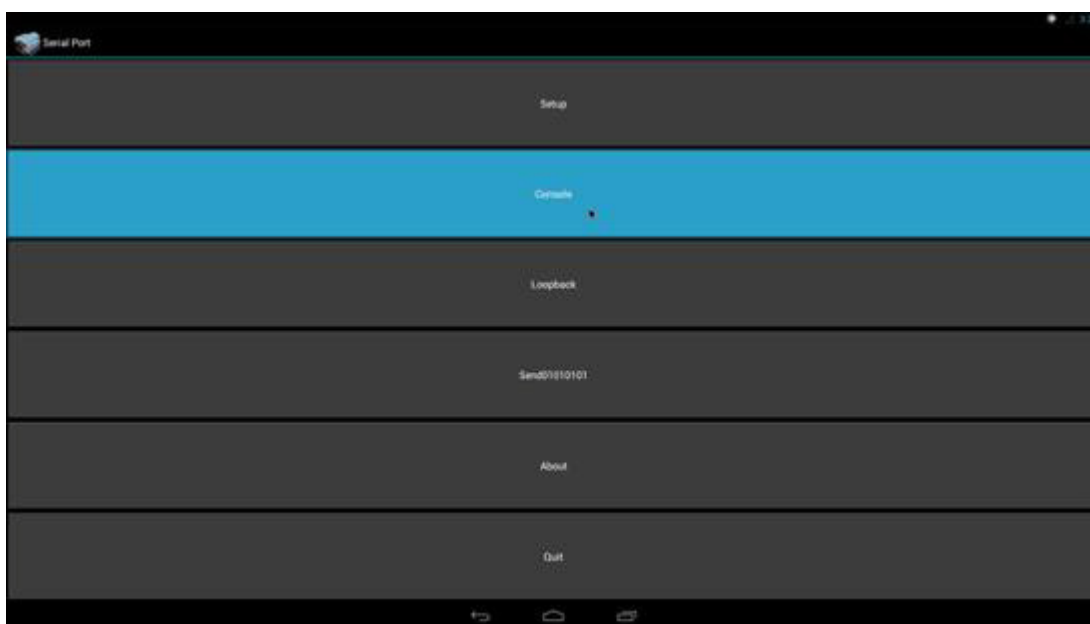

After typing some characters (ex. "This is a test. 123456789ABCDEF") and pressing Enter in serial terminal AP, an identical message will show up in reception block as below:



If you type "MESSAGE from Android" in emission block, an identical message will show up in serial terminal AP as below:

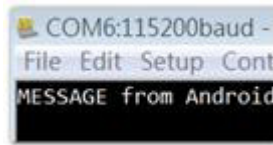

4.8.3 Loopback Test

1. Plug loopback device into ttymxc1
2. Click Loopback.
The loopback test result will show up as below

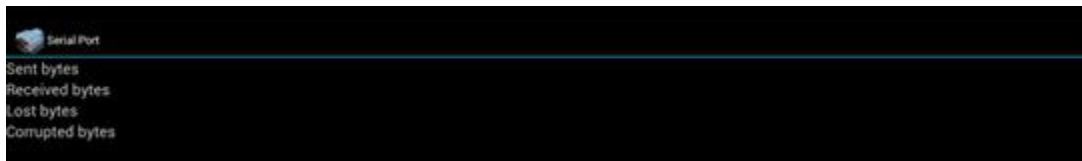

4.8.4 Send01010101 Test

1. Use a serial cable to connect ttymxc1 with PC/NB's serial port that should be configured to 115200 8N1, and open a serial terminal AP (like minicom, putty or teraterm)
2. Click Send01010101.
The character "U" (b'01010101) will show up continuously as below:

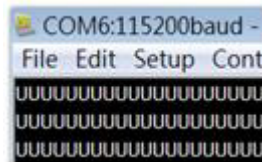

4.9 Network Setup

4.9.1 Wi-Fi

1. Click Settings.

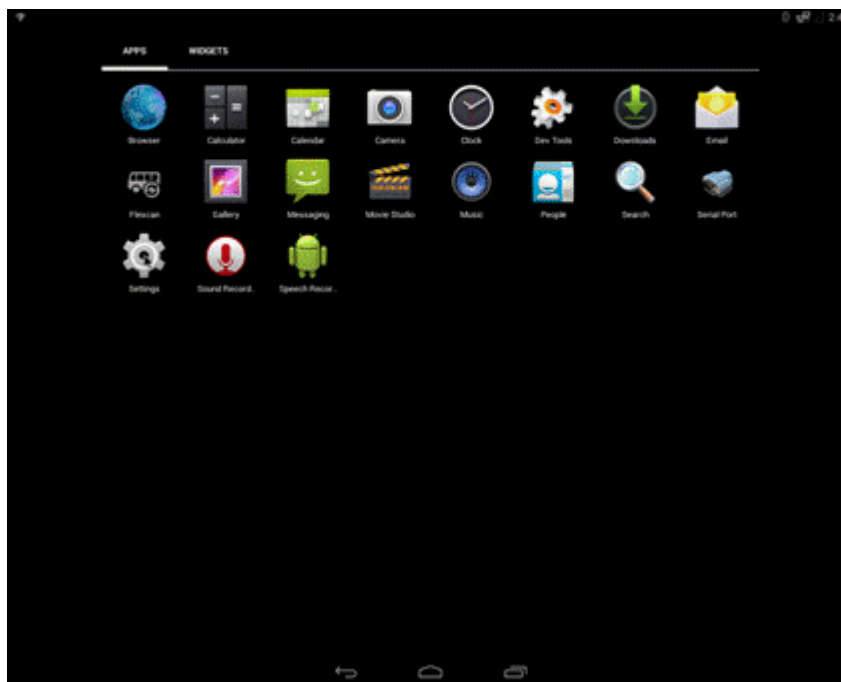

2. Turn Wi-Fi on.

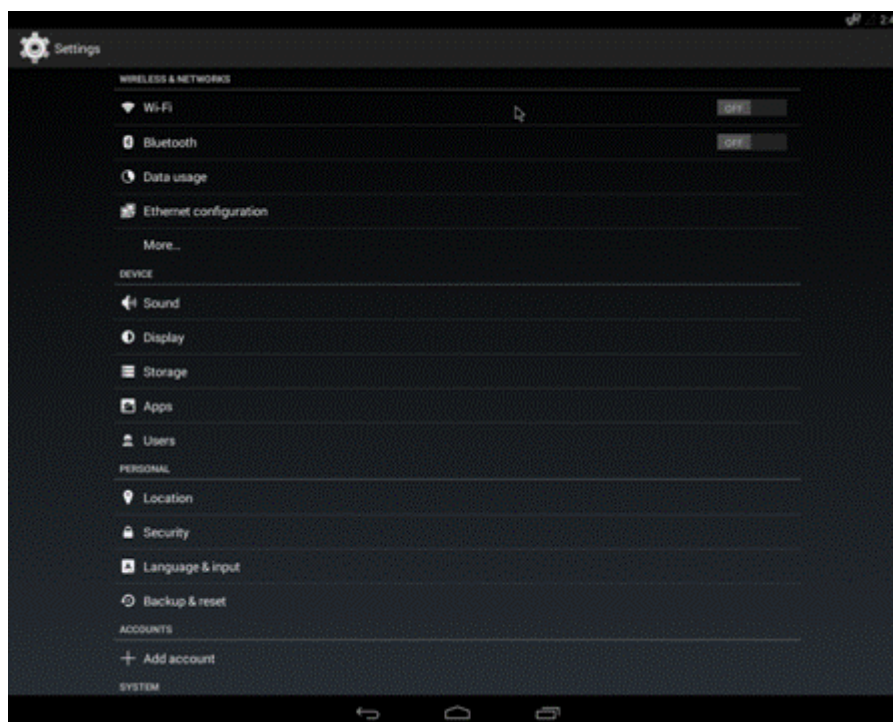

3. Choose ESSID (for example, Advantech for guest Testing)

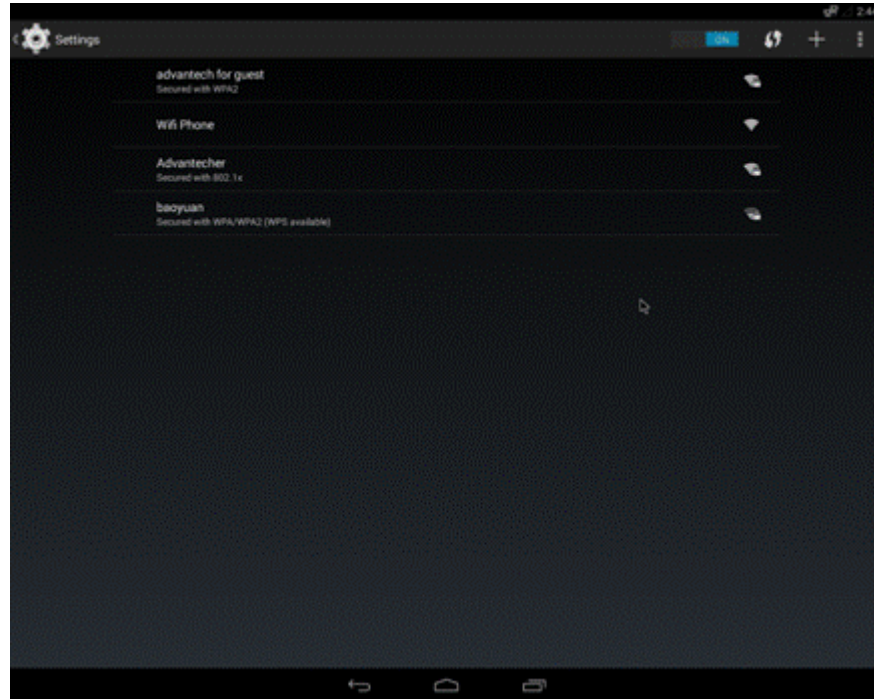

4. Input correct password.

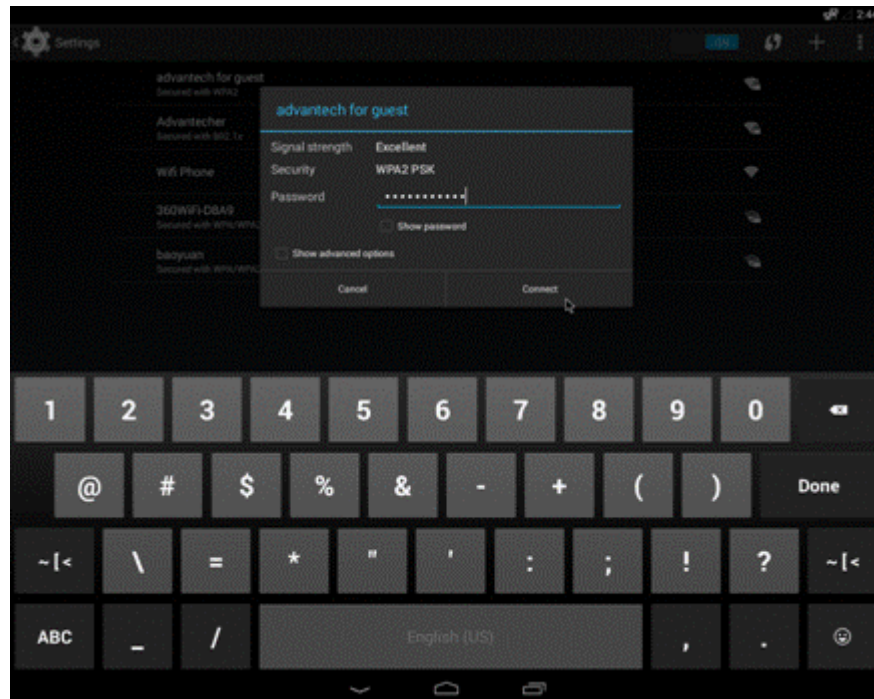

5. Wi-Fi Authenticating/Connecting/Obtaining IP address

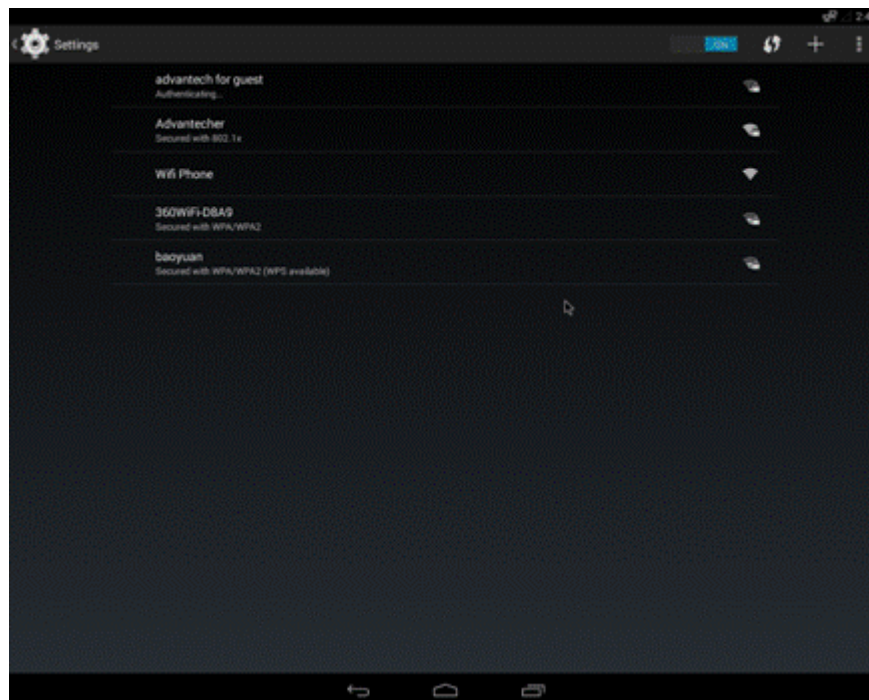

6. Wi-Fi connected

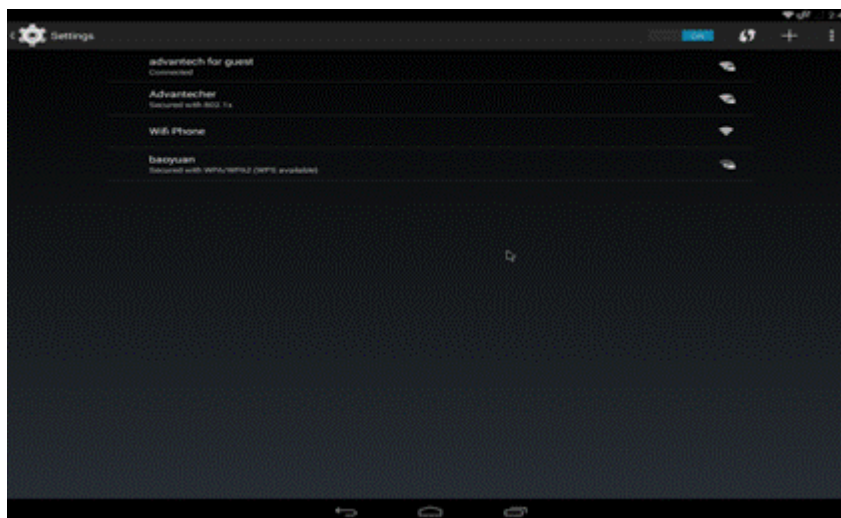

4.9.2 Bluetooth

1. Click Settings, switch the Bluetooth switch to ON to Turn on Bluetooth:



2. Click Settings / Bluetooth for bluetooth main interface:

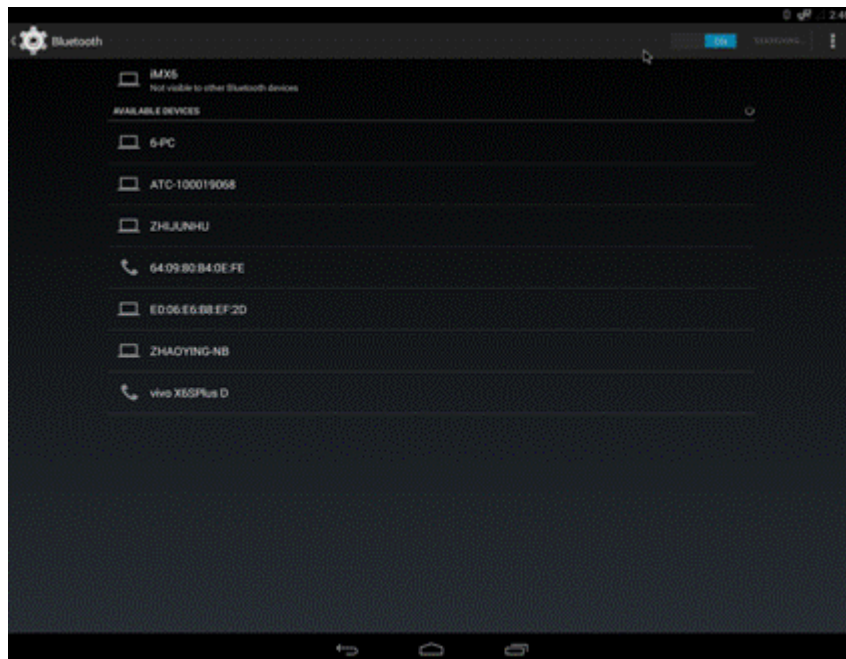

3. Click "iMX6" to let RSB-6410 bluetooth be visible to other Bluetooth devices

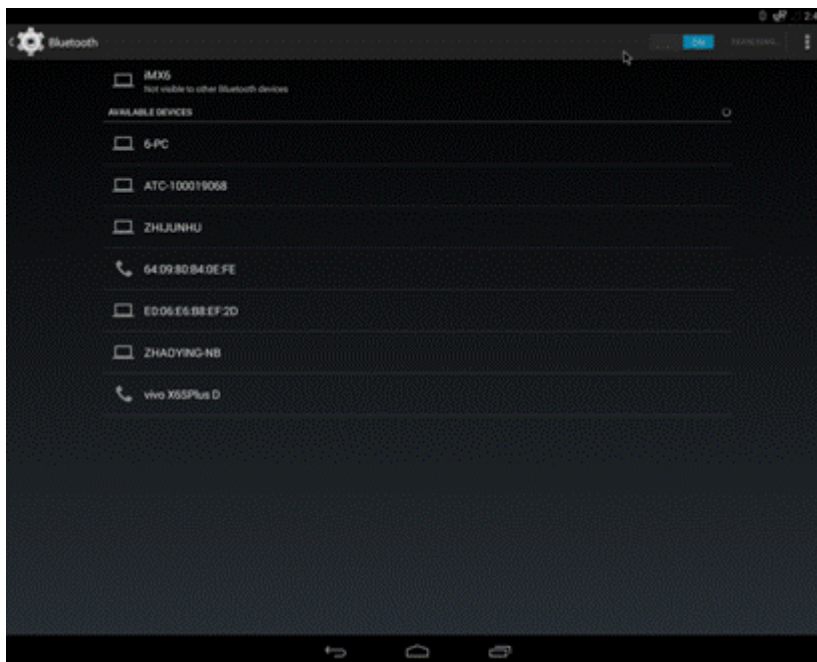

4. Click any available devices to pair with it:

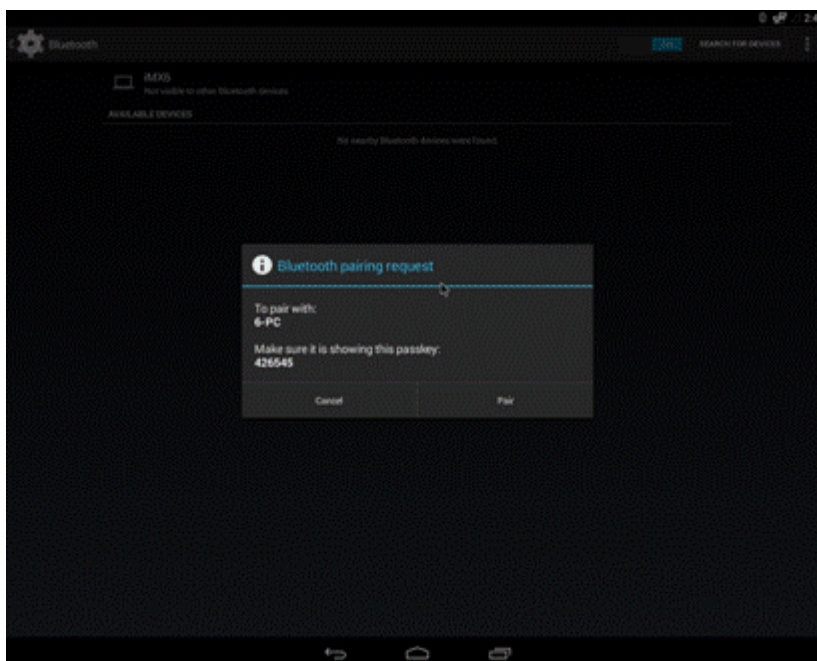

5. After pairing successfully with another Bluetooth device, you can communicate with it.

4.9.3 3G/4G

1. Insert Sim card and restart
2. If you can't connect to the network, please check the following settings:
 - A. Settings/More/Mobile networks/Data enabled, then Enabled.
 - B. Settings/More/Mobile networks/Access Point Names, then Correct.

4.9.4 Ethernet

1. Click Settings / Ethernet configuration, then turn on Ethernet

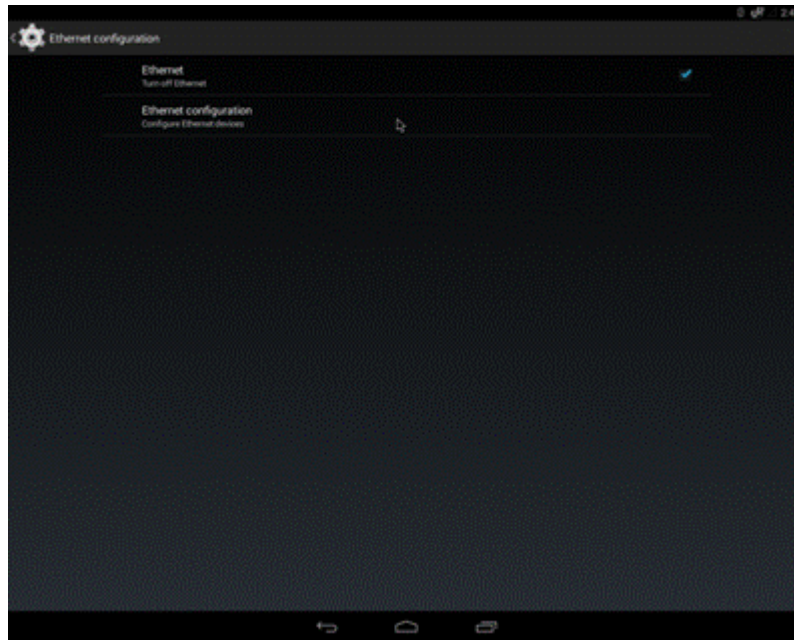

2. Click Ethernet configuration.

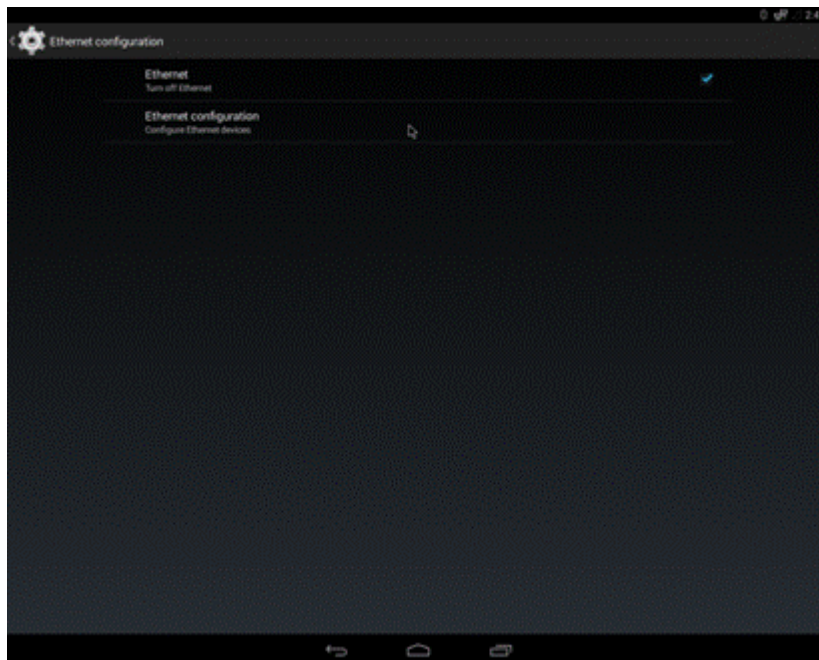

3. Choose Connection Type (DHCP or Static IP)

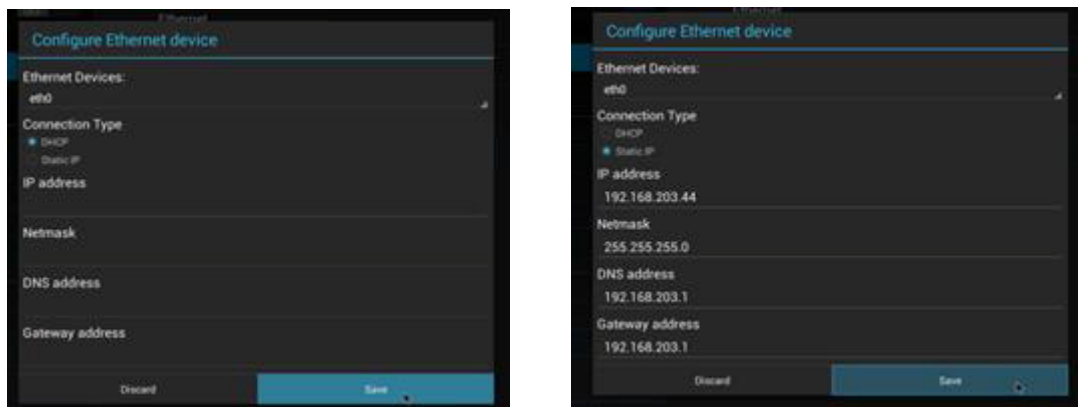

4.10 Can Test

1. Click Flexcan.

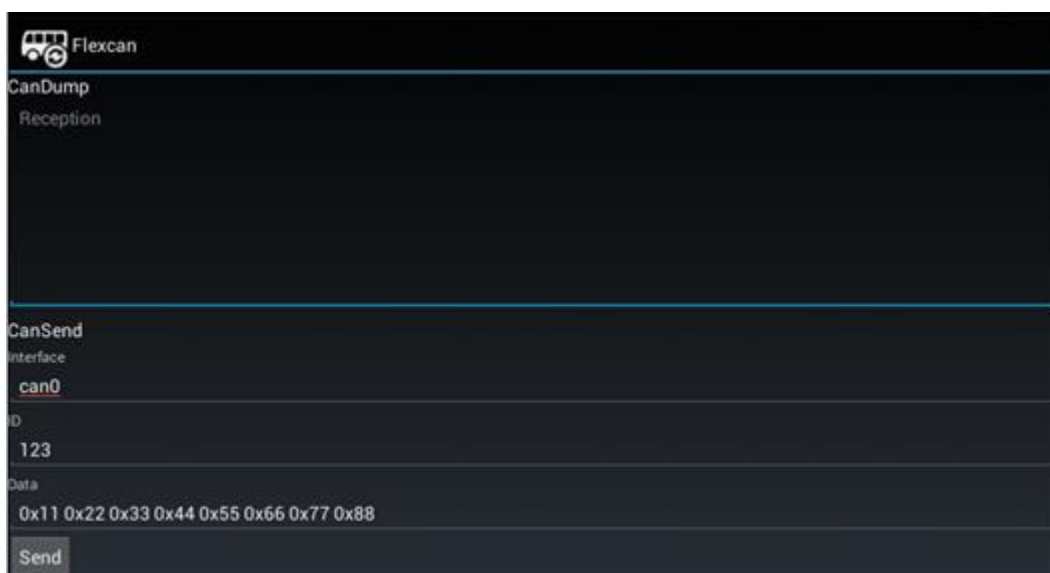

2. Edit "interface", "ID" and "Data", then click "Send" to send data through the Can port.

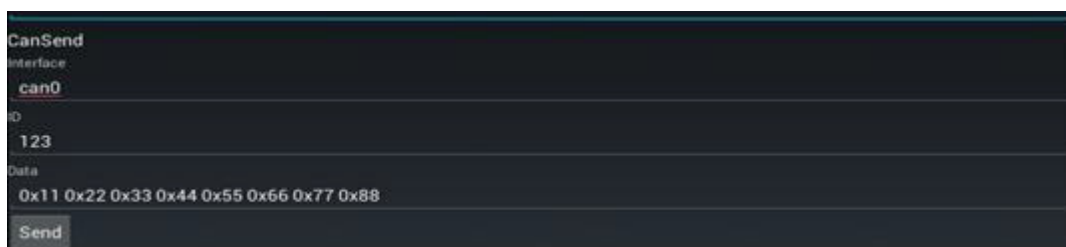

3. Received Data is displayed under the CanDump area.

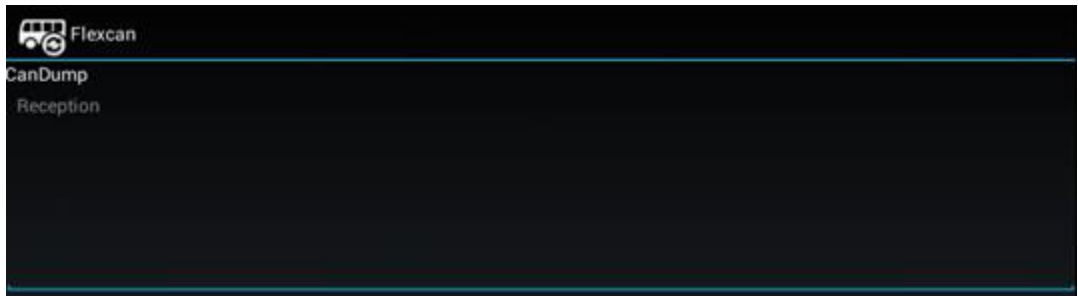

4.11 System Update

1. Refer to section 4.4.5 to build OTA package.
2. Insert your u disk.

Note! Make sure your u disk is FAT32 and has a update.zip file Under the first partition, such as /dev/sdb1.



3. Click Settings / About tablet / Addition system updates.

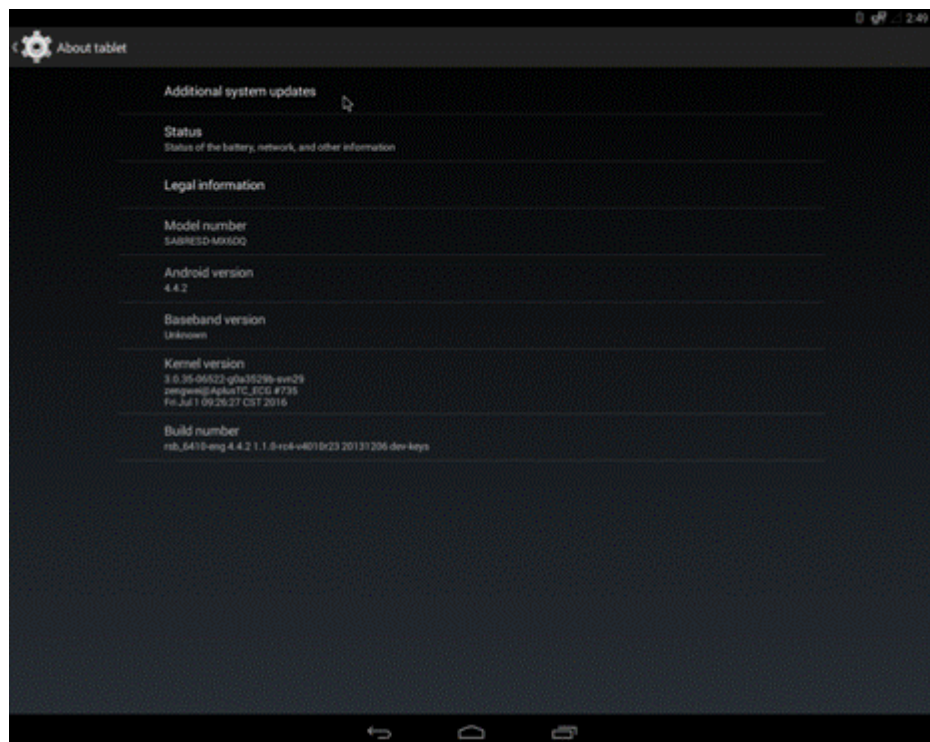

4. Wait for one moment, system will reboot for updating

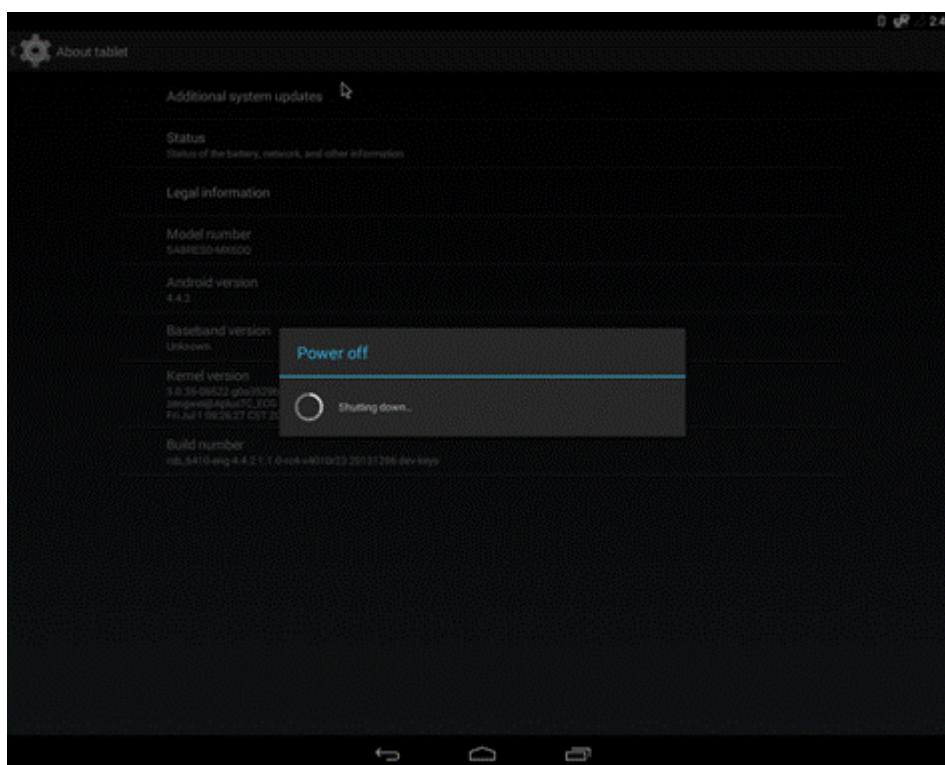

5. It will take some time to update.

4.12 System Reset

Factory data reset

1. Click settings / backup & reset, then enter into main interface.
2. Click Factory data reset.

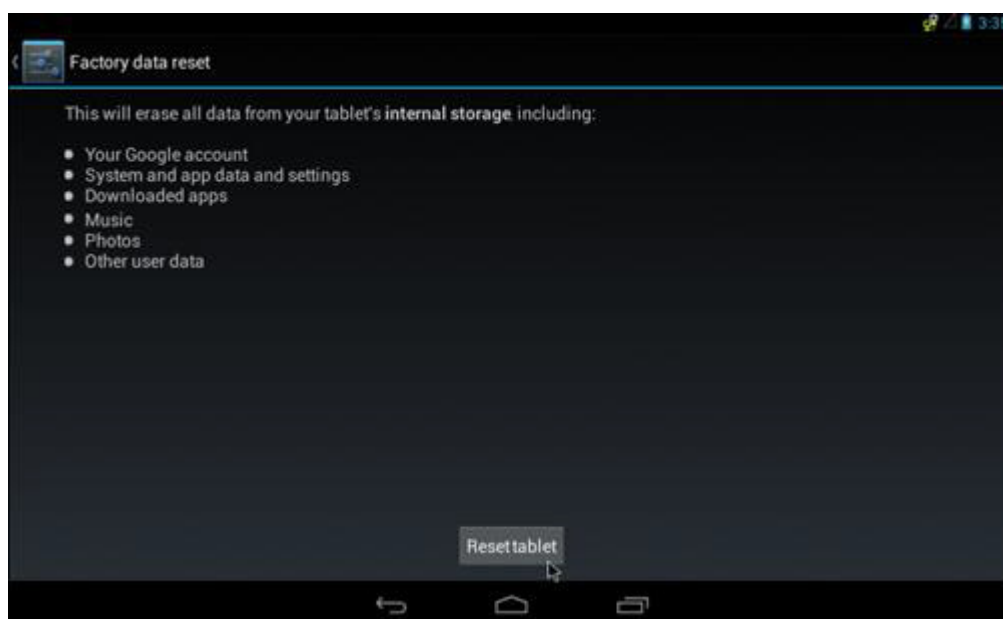

3. Click Reset to erase all data on the tablet.

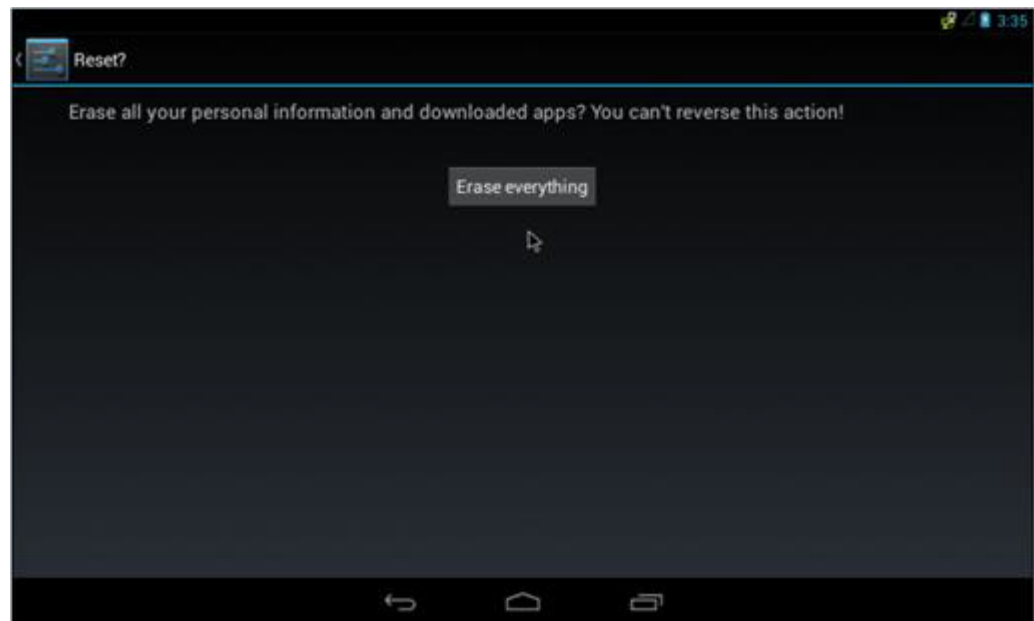

4. Click Erase everything.

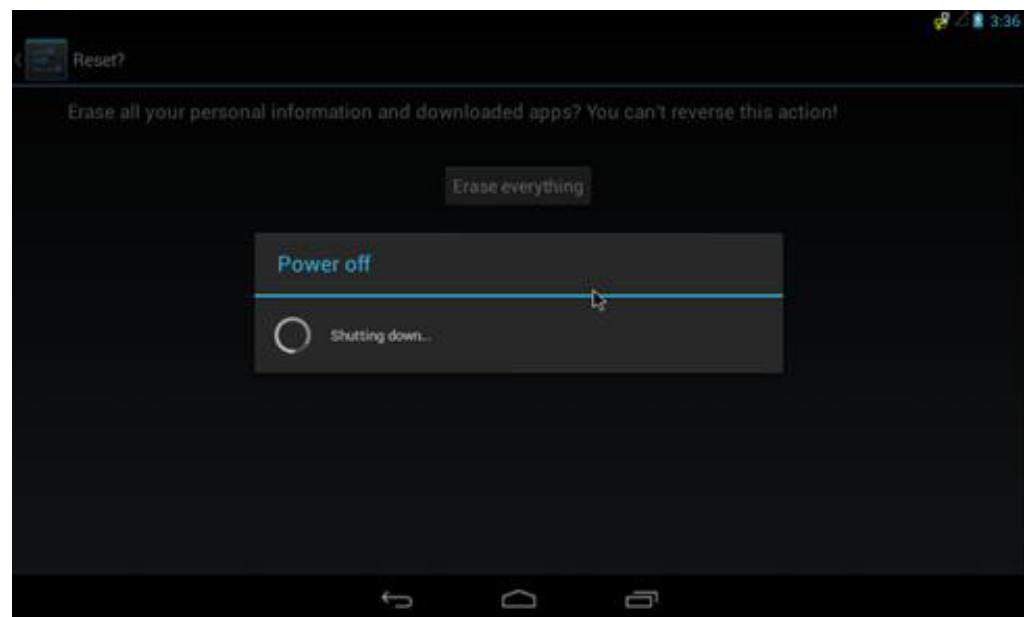

5. Wait for one moment, system will reboot and erase all user data.

4.13 Watchdog Function

The watchdog program is auto started when Android boots up. The default timeout time is 30 seconds and the watchdog keeps checking every 2 seconds. You can modify these two values below.

1. Edit init.rc(you can find it under **android_source_code/ device/fsl/RSB-6410/ init.rc**), find follow line:
[Advantech]Set watchdog timer to 30 seconds and pet it every 10 seconds to get a 20 seconds margin
service watchdogd /sbin/watchdogd 10 20
class core

Note! *The "10" means check time is every 10 secs!*



The "20" plus "10" means watchdog timeout is 30 secs!

So you can modify these two values to fit your requirement.

2. Rebuild the kernel image with your modification (refer to 4.4.2 Build android kernel) and create a bootable sd card to test.

Chapter 5

Advantech Services

This chapter introduces Advantech design in service, technical support and warranty policy for RSB-6410.

5.1 RISC Design-in Services

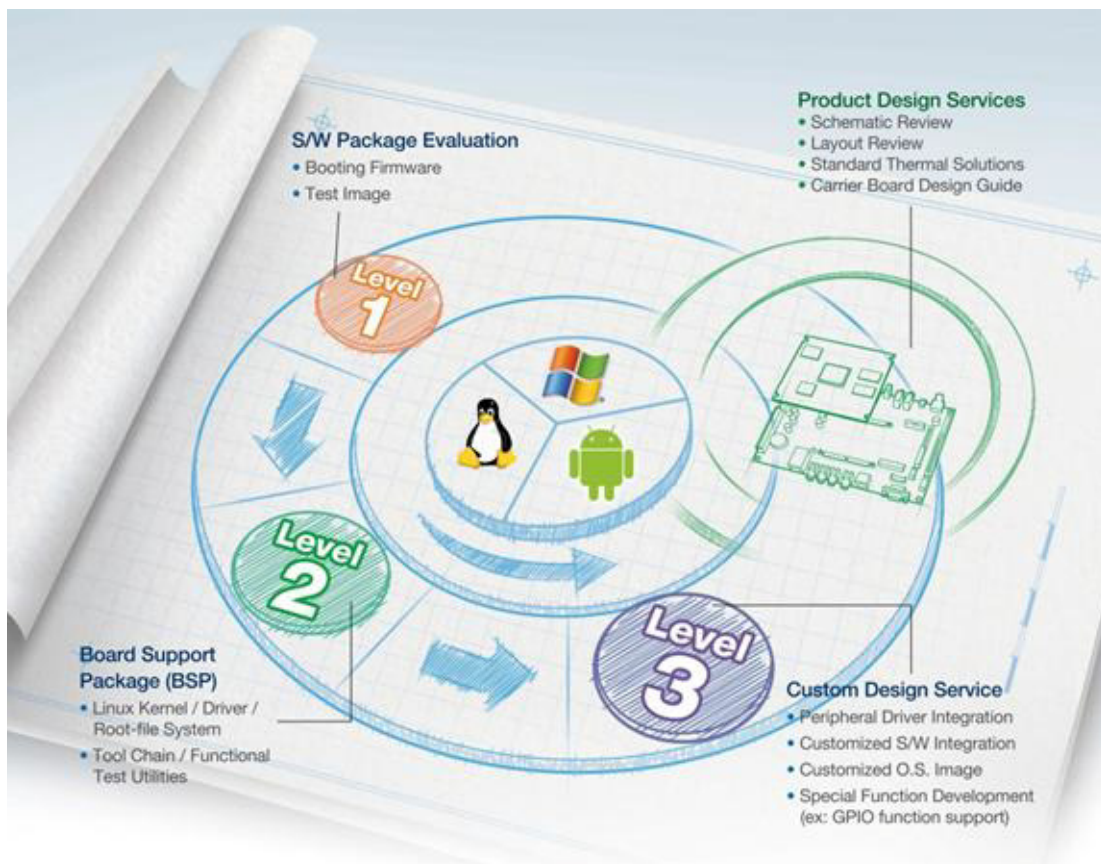

Advantech RISC Design-in Services help customers reduce the time and effort involved with designing new carrier boards. We handle the complexities of technical research and greatly minimize the development risk associated with carrier boards.

Easy Development

Advantech offers firmware support, root file-system, BSP and other develop tools. It helps customers to easily develop their carrier board and differentiate their embedded products and applications.

- Full Range of RISC Product Offerings
- Comprehensive Document Support

Design Assistance Service

Advantech provides a check list for engineers to check customer's carrier board schematics and compatibility. These services are preventative, and help to catch design errors before they happen. It helps to save a lot of time and costs with regard to developing carrier boards.

- Schematic Review
- Placement and Layout Review
- Debugging Assistance Services
- General/Special Reference Design Database.

Thermal Solution Services

In order to provide quicker and more flexible solutions for customer's thermal designs. Advantech provides thermal solution services including:

- Standard Thermal Solutions
- Customized Thermal Solutions

Embedded Software Services

We support driver development, software integration or customized firmware.

- Embedded Linux/ Android OS
- Advantech boot loader Customization

With the spread of industrial computing, a whole range of new applications have been developed, resulting in a fundamental change in the IPC industry. In the past System Integrators (SI) were used to completing projects without outside assistance but now such working models have moved on. Due to diverse market demands and intense competition, cooperation for (both upstream and downstream) vertical integration has become a much more effective way to create competitive advantage. ARM-based CPU modules were born out of this trend. Concentrating all necessary components on the CPU module and placing other parts on the carrier board in response to market requirements for specialization, provides greater flexibility while retaining low power consumption credentials.

Advantech has been involved in the industrial computer industry for many years and found that customers usually have the following questions when implementing modular designs.

General I/O design capability

Although customers possess the ability for vertical integration and have enough know-how and core competitiveness in the application field, the lack of expertise and experience in general power and I/O design causes many challenges for them, especially integrating CPU modules into their carrier board.

The acquisition of information

Even if an individual client is able to obtain sufficient information to make the right decision for a specialized vertical application, some customers encounter problems dealing with platform design in general and communication with the CPU or chipset, thereby increasing carrier board design difficulties and risk as well as seriously impacting on time-to-market and lost market opportunities.

Software development and modification

Compared to x86 architectures, RISC architectures use simpler instruction sets, therefore the software support for x86 platforms cannot be used on RISC platforms. System Integrators (SI) need to develop software for their system and do the hardware and software integration themselves. Unlike x86 platforms, RISC platforms have less support for Board Support Packages (BSP) and drivers and even though driver support is provided, SI still have to apply a lot of effort to integrate it into the system core. Moreover, the BSP provided by CPU manufacturers are usually for carrier board design, so it's difficult for SIs to have an environment for software development.

In view of this, Advantech proposed the concept of Streamlined Design-in Support Services for RISC-based Computer On Modules (COM). With a dedicated professional design-in services team, Advantech actively participates in carrier board

design and problem solving. Our services not only enable customers to effectively distribute their resources but also reduce R&D manpower cost and hardware investment.

By virtue of a close interactive relationship with leading original manufacturers of CPUs and chipsets such as ARM, TI and Freescale, Advantech helps solve communication and technical support difficulties and that can reduce the uncertainties of product development too. Advantech's professional software team focuses on providing a complete Board Support Package and assists customers to build up a software development environment for their RISC platforms.

Advantech RISC design-in services helps customers overcome their problems to achieve the most important goal of faster time to market through a streamlined RISC Design-in services.

Along with our multi-stage development process which includes: planning, design, integration, and validation, Advantech's RISC design-in service provides comprehensive support to the following different phases:

Planning stage

Before deciding to adopt Advantech RISC COM, customers must go through a complete survey process, including product features, specification, and compatibility testing with software. So, Advantech offers a RISC Customer Solution Board (CSB) as an evaluation tool for carrier boards which are simultaneously designed when developing RISC COMs. In the planning stage, customers can use this evaluation board to assess RISC modules and test peripheral hardware. What's more, Advantech provides a standard software Board Support Package (BSP) for RISC COM, so that customers can define their product's specifications as well as verifying I/O and performance at the same time. We not only offer hardware planning and technology consulting, but also software evaluation and peripheral module recommendations (such as WiFi, 3G, BT). Resolving customer concerns is Advantech's main target at this stage. Since we all know that product evaluation is the key task in the planning period, especially for performance and specification, so we try to help our customers conduct all the necessary tests for their RISC COM.

Design stage

When a product moves into the design stage, Advantech will supply a design guide of the carrier board for reference. The carrier board design guide provides pin definitions of the COM connector with limitations and recommendations for final design, so customers can have a clear guideline to follow during their carrier board development. Regarding different form factors, Advantech offers a complete pin-out check list for different form factors such as Q7, ULP and RTX2.0, so that customers can examine the carrier board signals and layout design accordingly. In addition, our team is able to assist customers to review the placement/layout and schematics to ensure the carrier board design meets their full requirements. For software development, Advantech RISC software team can assist customers to establish an environment for software development and evaluate the amount of time and resources needed. If customers outsource software development to a 3rd party, Advantech can also cooperate with the 3rd party and provide proficient consulting services. With Advantech's professional support, the design process becomes much easier and product quality will be improved to meet their targets.

Integration stage

This phase comprises of HW/SW integration, application development, and peripheral module implementation. Due to the lack of knowledge and experience on platforms, customers need to spend a certain amount of time on analyzing integration problems. In addition, peripheral module implementation has a lot to do with driver designs on carrier boards, RISC platforms usually have less support for ready-made drivers on the carrier board, therefore the customer has to learn from trial and error and finally get the best solution with the least effort. Advantech's team has years of experience in customer support and HW/SW development knowledge. Consequently, we can support customers with professional advice and information as well as shortening development time and enabling more effective product integration.

Validation stage

After customer's ES sample is completed, the next step is a series of verification steps. As a supportive role, Advantech primarily helps customers solve their problems in the testing process and will give suggestions and tips as well. Through an efficient verification process backed by our technical support, customers are able to optimize their applications with less fuss. Furthermore, Advantech's team can provide professional consulting services about further testing and equipment usage, so customers can find the right tools to efficiently identify and solve problems to further enhance their products quality and performance.

5.2 Contact Information

Below is the contact information for Advantech customer service.

Region/Country	Contact Information
America	1-888-576-9688
Brazil	0800-770-5355
Mexico	01-800-467-2415
Europe (Toll Free)	00800-2426-8080
Singapore & SAP	65-64421000
Malaysia	1800-88-1809
Australia (Toll Free)	1300-308-531
China (Toll Free)	800-810-0345 800-810-8389 Sales@advantech.com.cn
India (Toll Free)	1-800-425-5071
Japan (Toll Free)	0800-500-1055
Korea (Toll Free)	080-363-9494 080-363-9495
Taiwan (Toll Free)	0800-777-111
Russia (Toll Free)	8-800-555-01-50

On the other hand, you can reach our service team through below website, our technical support engineer will provide quick response once the form is filled out:

http://www.advantech.com.tw/contact/default.aspx?page=contact_form2&subject=Technical+Support

5.3 Global Service Policy

5.3.1 Warranty Policy

Below is the warranty policy of Advantech products:

5.3.1.1 Warranty Period

Advantech branded off-the-shelf products and 3rd party off-the-shelf products used to assemble Advantech Configure to Order products are entitled to a 2 years complete and prompt global warranty service. Product defect in design, materials, and workmanship, are covered from the date of shipment.

All customized products will by default carry a 15 months regional warranty service. The actual product warranty terms and conditions may vary based on sales contract.

All 3rd party products purchased separately will be covered by the original manufacturer's warranty and time period, and shall not exceed one year of coverage through Advantech.

5.3.1.2 Repairs under Warranty

It is possible to obtain a replacement (Cross-Shipment) during the first 30 days of the purchase, thru your original ADVANTECH supplier to arrange DOA replacement if the products were purchased directly from ADVANTECH and the product is DOA (Dead-on-Arrival). The DOA Cross-Shipment excludes any shipping damage, customized and/or build-to-order products.

For those products which are not DOA, the return fee to an authorized ADVANTECH repair facility will be at the customers' expense. The shipping fee for reconstructive products from ADVANTECH and back to the customers' site will be at ADVANTECH's expense.

5.3.1.3 Exclusions from Warranty

The product is excluded from warranty if

- The product has been found to be defective after expiry of the warranty period.
- Warranty has been voided by removal or alternation of product or part identification labels.
- The product has been misused, abused, or subjected to unauthorized disassembly/modification; placed in an unsuitable physical or operating environment; improperly maintained by the customer; or failure caused which ADVANTECH is not responsible whether by accident or other cause. Such conditions will be determined by ADVANTECH at its sole unfettered discretion.
- The product is damaged beyond repair due to a natural disaster such as a lightning strike, flood, earthquake, etc.
- Product updates/upgrades and tests upon the request of customers who are without warranty.

5.3.2 Repair Process

5.3.2.1 Obtaining an RMA Number

All returns from customers must be authorized with an ADVANTECH RMA (Return Merchandise Authorization) number. Any returns of defective units or parts without valid RMA numbers will not be accepted; they will be returned to the customer at the customer's cost without prior notice.

An RMA number is only an authorization for returning a product; it is not an approval for repair or replacement. When requesting an RMA number, please access ADVANTECH's RMA web site: <http://erma.ADVANTECH.com.tw> with an authorized user ID and password.

You must fill out basic product and customer information and describe the problems encountered in detail in "Problem Description". Vague entries such as "does not work" and "failure" are not acceptable.

If you are uncertain about the cause of the problem, please contact ADVANTECH's Application Engineers (AE). They may be able to find a solution that does not require sending the product for repair.

The serial number of the whole set is required if only a key defective part is returned for repair. Otherwise, the case will be regarded as out-of-warranty.

5.3.2.2 Returning the Product for Repair

It's possible customers can save time and meet end-user requirements by returning defective products to any authorized ADVANTECH repair facility without an extra cross-region charge. It is required to contact the local repair center before offering global repair service.

It is recommended to send cards without accessories (manuals, cables, etc.). Remove any unnecessary components from the card, such as CPU, DRAM, and CF Card. If you send all these parts back (because you believe they may be part of the problem), please note clearly that they are included. Otherwise, ADVANTECH is not responsible for any items not listed. Make sure the "Problem Description" is enclosed.

European Customers that are located outside European Community are requested to use UPS as the forwarding company. We strongly recommend adding a packing list to all shipments. Please prepare a shipment invoice according to the following guidelines to decrease goods clearance time:

1. Give a low value to the product on the invoice, or additional charges will be levied by customs that will be borne by the sender.
2. Add information "Invoice for customs purposes only with no commercial value" on the shipment invoice.
3. Show RMA numbers, product serial numbers and warranty status on the shipment invoice.
4. Add information about Country of origin of goods

In addition, please attach an invoice with RMA number to the carton, then write the RMA number on the outside of the carton and attach the packing slip to save handling time. Please also address the parts directly to the Service Department and mark the package "Attn. RMA Service Department".

All products must be returned in properly packed ESD material or anti-static bags. ADVANTECH reserves the right to return unrepaired items at the customer's cost if inappropriately packed.

Besides that, "Door-to-Door" transportation such as speed post is recommended for delivery, otherwise, the sender should bear additional charges such as clearance fees if Air-Cargo is adopted.

Should DOA cases fail, ADVANTECH will take full responsibility for the product and transportation charges. If the items are not DOA, but fail within warranty, the sender will bear the freight charges. For out-of-warranty cases, customers must cover the cost and take care of both outward and inward transportation.

5.3.2.3 Service Charges

The product is excluded from warranty if :

- The product is repaired after expiry of the warranty period.
- The product is tested or calibrated after expiry of the warranty period, and a No Problem Found (NPF) result is obtained.
- The product, though repaired within the warranty period, has been misused, abused, or subjected to unauthorized disassembly/modification; placed in an unsuitable physical or operating environment; improperly maintained by the customer; or failure caused which ADVANTECH is not responsible whether by accident or other cause. Such conditions will be determined by ADVANTECH at its sole unfettered discretion.
- The product is damaged beyond repair due to a natural disaster such as a lightning strike, flood, earthquake, etc.
- Product updates and tests upon the request of customers who are without warranty.

If a product has been repaired by ADVANTECH, and within three months after such a repair the product requires another repair for the same problem, ADVANTECH will do this repair free of charge. However, such free repairs do not apply to products which have been misused, abused, or subjected to unauthorized disassembly/modification; placed in an unsuitable physical or operating environment; improperly maintained by the customer; or failure caused which ADVANTECH is not responsible whether by accident or other cause.

Please contact your nearest regional service center for detail service quotation.

Before we start out-of-warranty repairs, we will send you a pro forma invoice (P/I) with the repair charges. When you remit the funds, please reference the P/I number listed under "Our Ref". ADVANTECH reserves the right to deny repair services to customers that do not return the DOA unit or sign the P/I. Meanwhile, ADVANTECH will scrap defective products without prior notice if customers do not return the signed P/I within 3 months.

5.3.2.4 Repair Report

ADVANTECH returns each product with a "Repair Report" which shows the result of the repair. A "Repair Analysis Report" is also provided to customers upon request. If the defect is not caused by ADVANTECH design or manufacturing, customers will be charged US\$60 or US\$120 for in-warranty or out-of-warranty repair analysis reports respectively.

5.3.2.5 Custody of Products Submitted for Repair

ADVANTECH will retain custody of a product submitted for repair for one month while it is waiting for return of a signed P/I or payment (A/R). If the customer fails to respond within such period, ADVANTECH will close the case automatically. ADVANTECH will take reasonable measures to stay in proper contact with the customer during this one month period.

5.3.2.6 Shipping Back to Customer

The forwarding company for RMA returns from ADVANTECH to customers is selected by ADVANTECH. Per customer requirement, other express services can be adopted, such as UPS, FedEx and etc. The customer must bear the extra costs of such alternative shipment. If you require any special arrangements, please indicate this when shipping the product to us.

ADVANTECH

Enabling an Intelligent Planet

www.advantech.com

Please verify specifications before quoting. This guide is intended for reference purposes only.

All product specifications are subject to change without notice.

No part of this publication may be reproduced in any form or by any means, electronic, photocopying, recording or otherwise, without prior written permission of the publisher.

All brand and product names are trademarks or registered trademarks of their respective companies.

© Advantech Co., Ltd. 2016