

Round Through-Hole LED Lamp (5 mm)

OVLFX3C7



Features:

- High brightness with well-defined spatial radiation patterns
- UV-resistant epoxy lens
- 30° Beam Angle

Description:

Each device in the OVLFX3C7 series is a high-intensity LED mounted in a clear plastic T-1 $\frac{3}{4}$ package. The LED provides a well-defined and even emission pattern. The UV-resistant epoxy lens makes this device an optimal solution for outdoor applications.

Applications:

- Traffic and pedestrian signals
- Signage and architectural lighting
- Backlighting
- Automotive

Part Number	Material	Emitted Color	Intensity Typ. mcd	Lens Color
OVLFB3C7	InGaN	Blue	5,200	Clear
OVLFG3C7	InGaN	Green	16,000	Clear
OVLFR3C7	AllnGaP	Red	7,400	Clear
OVLFY3C7	AllnGaP	Yellow	7,400	Clear

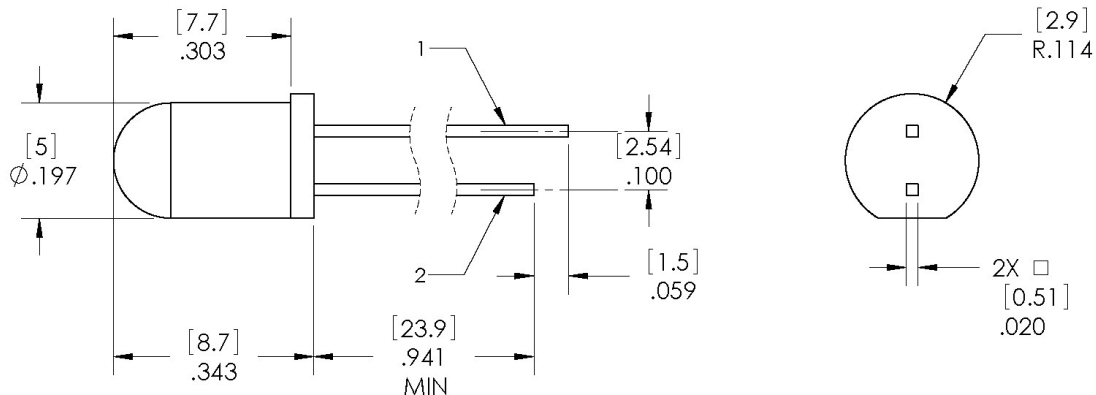

1 ANODE 2 CATHODE DIMENSIONS ARE IN INCHES AND [MILLIMETERS].

Leadframe material is iron alloy with tin-plated leads

DO NOT LOOK DIRECTLY AT LED WITH UNSHIELDED EYES OR DAMAGE TO RETINA MAY OCCUR.

General Note

TT Electronics reserves the right to make changes in product specification without notice or liability. All information is subject to TT Electronics' own data and is considered accurate at time of going to print.

TT Electronics | OPTEK Technology
2900 E. Plano Pkwy, Plano, TX 75074 | Ph: +1 972 323 2200
www.ttelectronics.com | sensors@ttelectronics.com

Round Through-Hole LED Lamp (5 mm)

OVLFX3C7



Electrical Specifications

Absolute Maximum Ratings ($T_A = 25^\circ\text{C}$ unless otherwise noted)

Storage Temperature Range		-40 ~ +100 °C
Operating Temperature Range		-40 ~ +100 °C
Reverse Voltage		5 V
Continuous Forward Current	Blue, Green	25 mA
Continuous Forward Current	Red, Yellow	50 mA
Peak Forward Current (10% Duty Cycle, 1 kHz)	Blue, Green	100 mA
Peak Forward Current (10% Duty Cycle, 1 kHz)	Red, Yellow	100 mA
Power Dissipation	Blue, Green	100 mW
Power Dissipation	Red, Yellow	120 mW
Current Linearity vs Ambient Temperature	Blue, Green	-0.29 mA/°C
Current Linearity vs Ambient Temperature	Red, Yellow	-0.72 mA/°C
Electrostatic Discharge Classification (JEDEC-JESD22-A114F)		Class 1C
LED Junction Temperature		125 °C
Lead Soldering Temperature (4 mm from the base of the epoxy bulb)		260 °C / 5 seconds

Electrical Characteristics $T_A = 25^\circ\text{C}$ unless otherwise noted

SYMBOL	PARAMETER	COLOR	MIN	TYP	MAX	UNITS	CONDITIONS
I_V	Luminous Intensity	Blue	3,115	5,200	----	mcd	$I_F = 20\text{ mA}$
		Green	8,550	16,000	----		
		Red	4,360	7,400	----		
		Yellow	4,360	7,400	----		
V_F	Forward Voltage	Blue	2.6	3.4	4.0	V	$I_F = 20\text{ mA}$
		Green					
		Red	1.8	2.0	2.4		
		Yellow					
I_R	Reverse Current	Blue	----	----	10	μA	$V_R = 5\text{ V}$
		Green					
		Red					
		Yellow					
λ_D	Dominant Wavelength	Blue	460	470	475	nm	$I_F = 20\text{ mA}$
		Green	519	525	531		
		Red	620	623	630		
		Yellow	585	589	595		
$\Delta\lambda$	Spectra Half Width	Blue	----	25	----	nm	$I_F = 20\text{ mA}$
		Green					
		Red					
		Yellow					
20½H-H	50% Power Angle		----	30	----	deg	$I_F = 20\text{ mA}$

General Note

TT Electronics reserves the right to make changes in product specification without notice or liability. All information is subject to TT Electronics' own data and is considered accurate at time of going to print.

TT Electronics | OPTEK Technology
 2900 E. Plano Pkwy, Plano, TX 75074 | Ph: +1 972 323 2200
www.ttelectronics.com | sensors@ttelectronics.com

Round Through-Hole LED Lamp (5 mm)

OVLFX3C7



Typical Electro-Optical Characteristics Curves (BLUE)

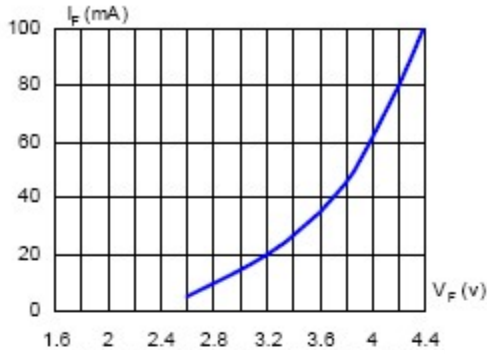

Fig. 1 Forward Current vs. Forward Voltage

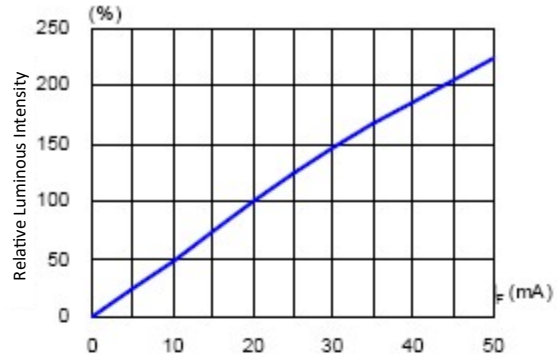

Fig. 2 Luminous Intensity vs. Forward Current

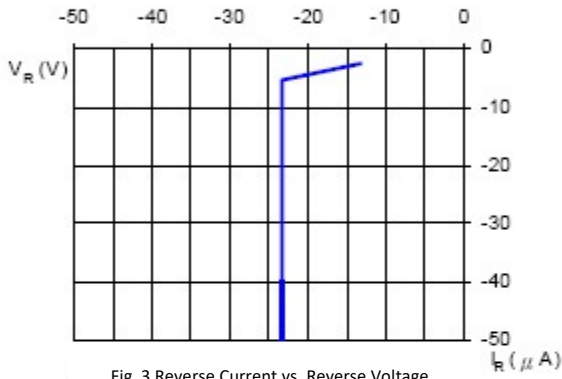

Fig. 3 Reverse Current vs. Reverse Voltage

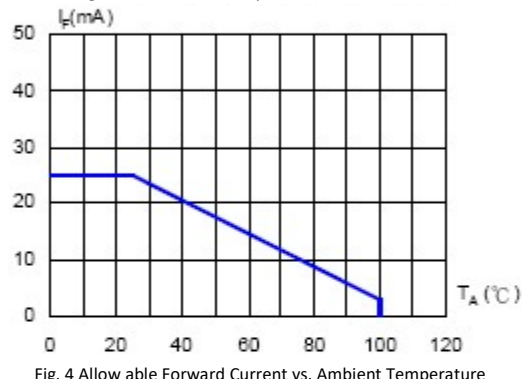

Fig. 4 Allowable Forward Current vs. Ambient Temperature

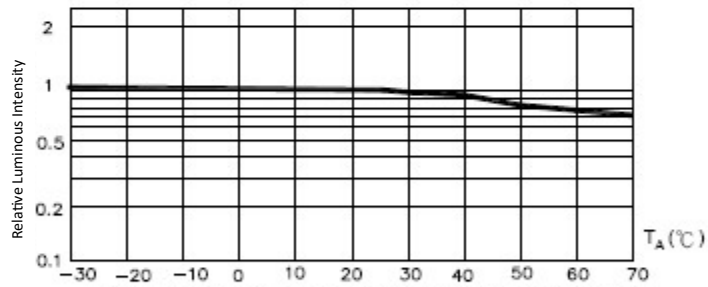

Fig. 5 Luminous Intensity at $I_F = 20mA$ vs. Ambient Temperature

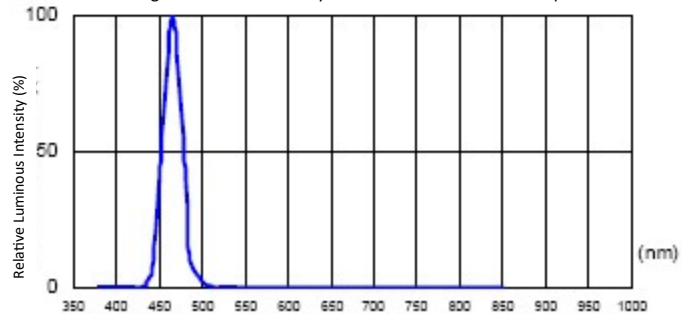

Fig. 6 Relative Luminous Intensity vs. Wavelength

General Note

TT Electronics reserves the right to make changes in product specification without notice or liability. All information is subject to TT Electronics' own data and is considered accurate at time of going to print.

TT Electronics | OPTEK Technology
2900 E. Plano Pkwy, Plano, TX 75074 | Ph: +1 972 323 2200
www.ttelectronics.com | sensors@ttelectronics.com

Round Through-Hole LED Lamp (5 mm)

OVLFX3C7



Typical Electro-Optical Characteristics Curves (GREEN)

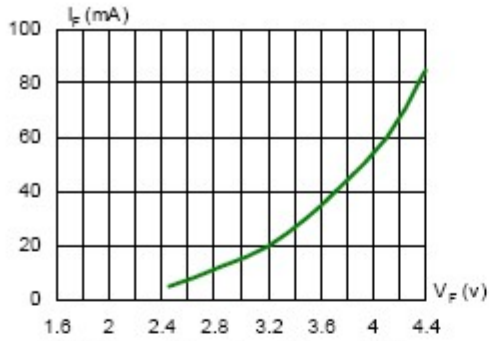

Fig.1 Forward Current vs Forward Voltage

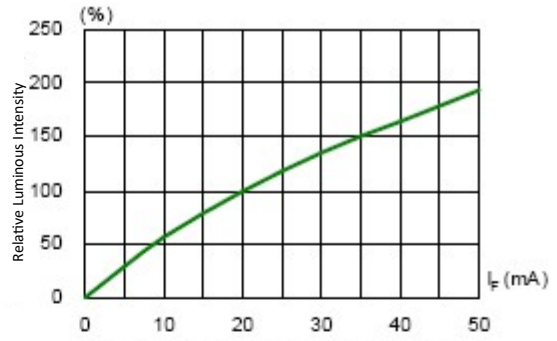

Fig. 2 Luminous Intensity vs. Forward Current

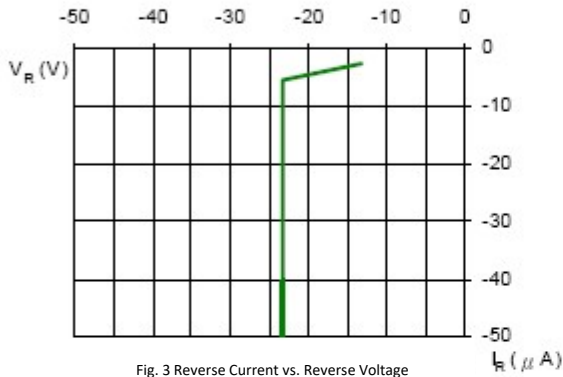

Fig. 3 Reverse Current vs. Reverse Voltage

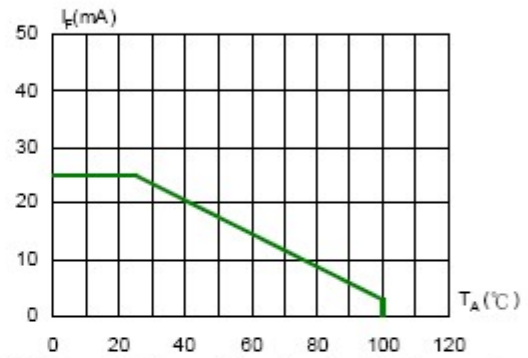

Fig. 4 Allowable Forward Current vs. Ambient Temperature

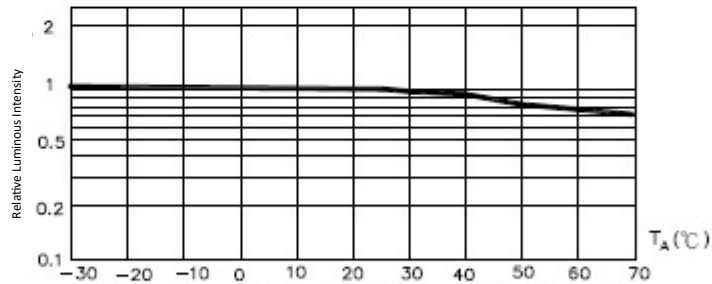

Fig. 5 Luminous Intensity at $I_F = 20mA$ vs. Ambient Temperature

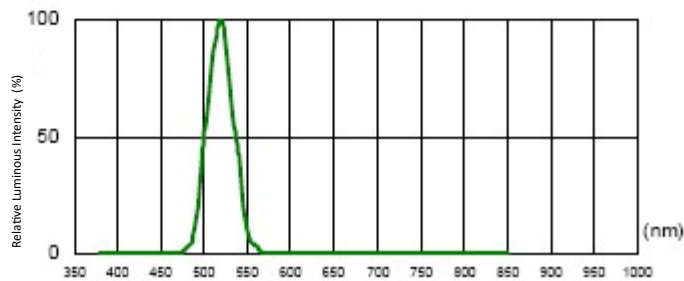

Fig. 6 Relative Luminous Intensity vs. Wavelength

General Note

TT Electronics reserves the right to make changes in product specification without notice or liability. All information is subject to TT Electronics' own data and is considered accurate at time of going to print.

TT Electronics | OPTEK Technology
2900 E. Plano Pkwy, Plano, TX 75074 | Ph: +1 972 323 2200
www.ttelectronics.com | sensors@ttelectronics.com

Round Through-Hole LED Lamp (5 mm)

OVLFX3C7



Typical Electro-Optical Characteristics Curves (RED)

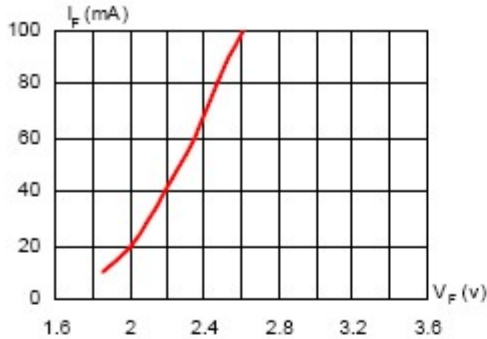

Fig. 1 Forward Current vs. Forward Voltage

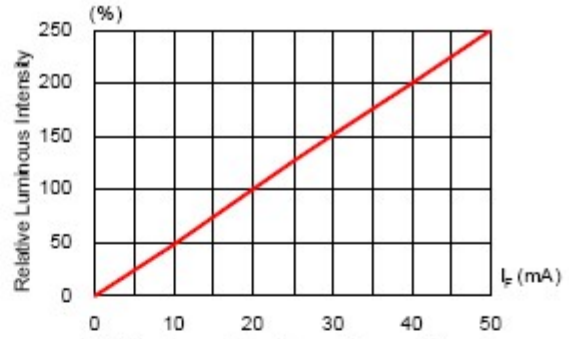

Fig. 2 Luminous Intensity vs. Forward Current

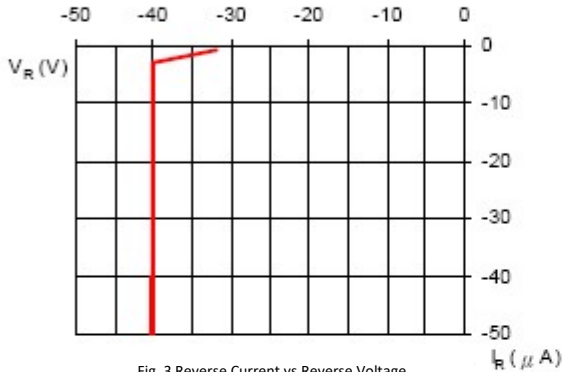

Fig. 3 Reverse Current vs. Reverse Voltage

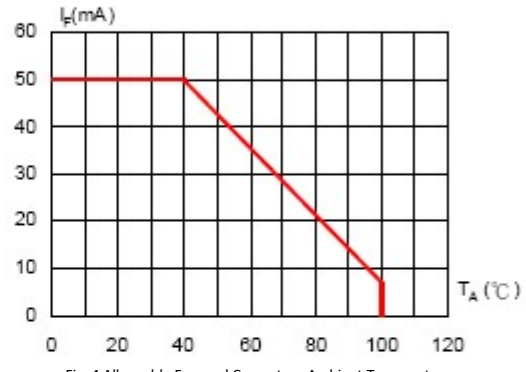

Fig. 4 Allowable Forward Current vs. Ambient Temperature

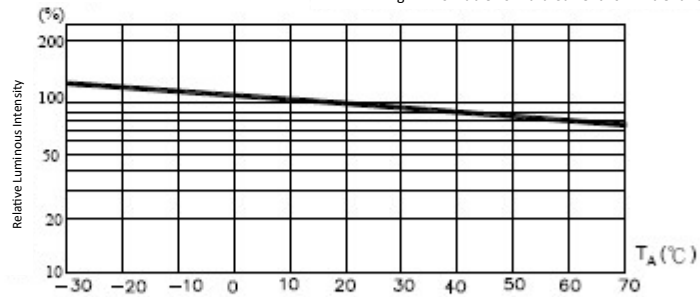

Fig. 5 Luminous Intensity at $I_F = 20mA$ vs. Ambient Temperature

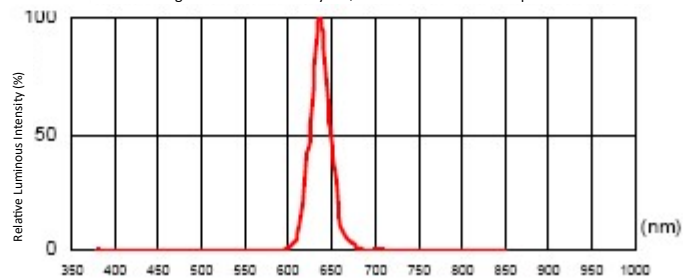

Fig. 6 Relative Luminous Intensity vs. Wavelength

General Note

TT Electronics reserves the right to make changes in product specification without notice or liability. All information is subject to TT Electronics' own data and is considered accurate at time of going to print.

TT Electronics | OPTEK Technology
2900 E. Plano Pkwy, Plano, TX 75074 | Ph: +1 972 323 2200
www.ttelectronics.com | sensors@ttelectronics.com

Round Through-Hole LED Lamp (5 mm)

OVLFX3C7



Typical Electro-Optical Characteristics Curves (YELLOW)



Fig. 1 Forward Current vs. Forward Voltage

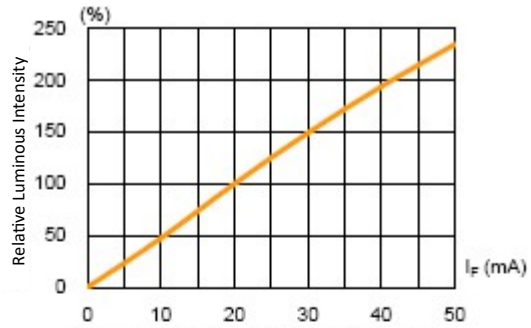

Fig. 2 Luminous Intensity vs. Forward Current

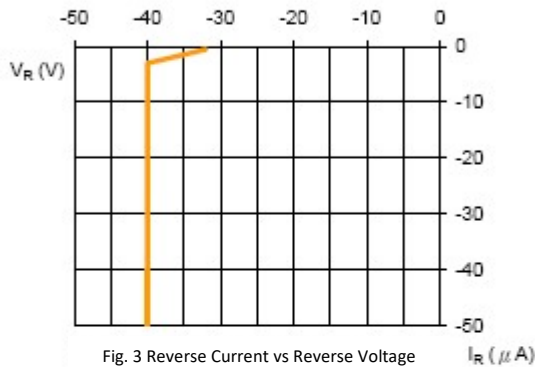

Fig. 3 Reverse Current vs. Reverse Voltage

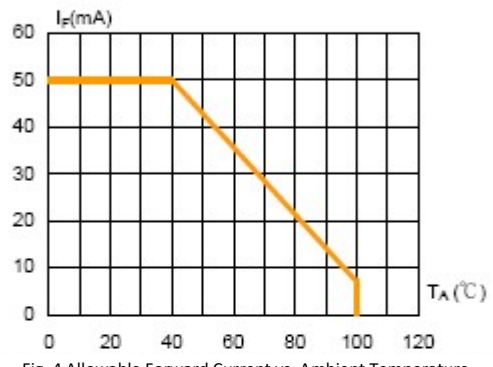

Fig. 4 Allowable Forward Current vs. Ambient Temperature

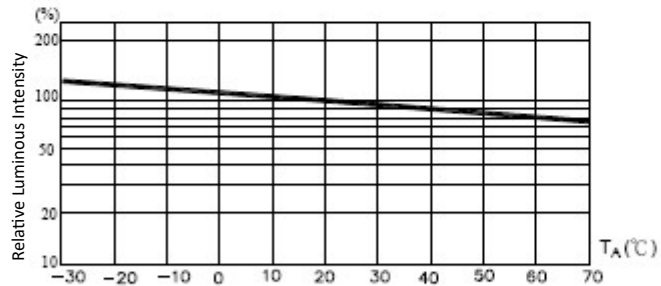

Fig. 5 Luminous Intensity at $I_F = 20mA$ vs. Ambient Temperature

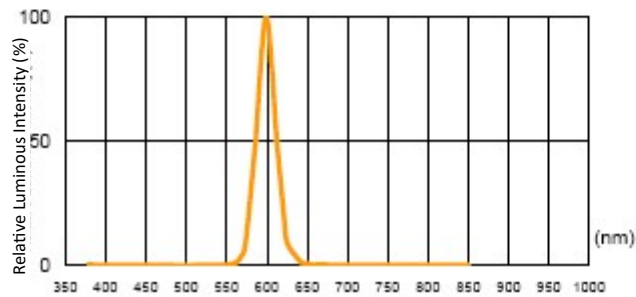

Fig. 6 Relative Luminous Intensity vs. Wavelength

General Note

TT Electronics reserves the right to make changes in product specification without notice or liability. All information is subject to TT Electronics' own data and is considered accurate at time of going to print.

TT Electronics | OPTEK Technology
2900 E. Plano Pkwy, Plano, TX 75074 | Ph: +1 972 323 2200
www.ttelectronics.com | sensors@ttelectronics.com

Round Through-Hole LED Lamp (5 mm)

OVLFX3C7



Beam Pattern

(RED) and (YELLOW)

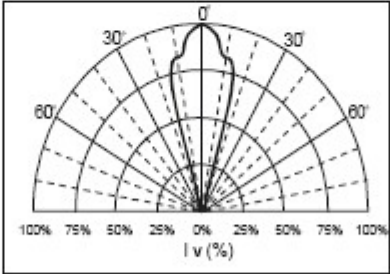

(BLUE) and (GREEN)

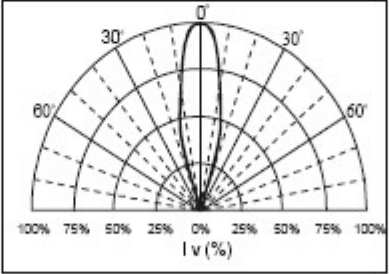

Packaging: 500 pcs per bulk bag with desiccant

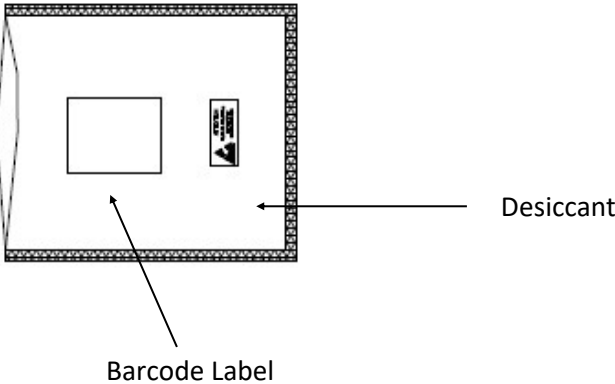

General Note
TT Electronics reserves the right to make changes in product specification without notice or liability. All information is subject to TT Electronics' own data and is considered accurate at time of going to print.

Round Through-Hole LED Lamp (5 mm)

OVLFX3C7



Reliability Test

LED lamps are checked by reliability tests based on MIL standards.

Classification	Test Item	Standard Test Method	Test Conditions	Duration	Unit	Acc / Rej Criteria	Result
Life Test	Operation Life Test (OLT)	MIL-STD-750D Method 1026.3	$T_A=25^{\circ}\text{C}$, $I_F=30\text{mA}$ *	1000 Hrs	100	0 / 1	Pass
Environment Test	High Temperature Storage (HTS)	MIL-STD-750D Method 1032.1	$T_A=100^{\circ}\text{C}$	1000 Hrs	100	0 / 1	Pass
	Low Temperature Storage (LTS)	MIL-STD-750D Method 1032.1	$T_A=-40^{\circ}\text{C}$	1000 Hrs	100	0 / 1	Pass
	Temp. & Humidity with Bias (THB)	MIL-STD-750D Method 103B	$T_A=85^{\circ}\text{C}$, $\text{Rh}=85\%$ $I_F=20\text{mA}$ **	500 Hrs	100	0 / 1	Pass
	Thermal Shock Test (TST)	MIL-STD-750D Method 1056.1	$0^{\circ}\text{C} \sim 100^{\circ}\text{C}$ 2min 2min	100 cycles	100	0 / 1	Pass
	Temperature Cycling Test (TCT)	MIL-STD-750D Method 1051.5	$-40^{\circ}\text{C} \sim 25^{\circ}\text{C} \sim 100^{\circ}\text{C} \sim 25^{\circ}\text{C}$ 30min 5min 30min 5min	100 cycles	100	0 / 1	Pass
Mechanical Test	Solderability	MIL-STD-750D Method 2026.4	$235\pm 5^{\circ}\text{C}$, 5 sec	1 time	20	0 / 1	Pass
	Resistance to Soldering Heat	MIL-STD-750D Method 2031.1	$260\pm 5^{\circ}\text{C}$, 10 sec	1 time	20	0 / 1	Pass
	Lead Integrity	MIL-STD-750D Method 2036.3	Load 2.5N (0.25kgf) $0^{\circ} \sim 90^{\circ} \sim 0^{\circ}$, bend	3 times	20	0 / 1	Pass

Remark : (*) $I_F=30\text{mA}$ for AlInGaP chip ; $I_F=20\text{mA}$ for InGaN chip
 (**) $I_F=20\text{mA}$ for AlInGaP chip ; $I_F=10\text{mA}$ for InGaN chip

2. Failure Criteria ($T_A=25^{\circ}\text{C}$):

Test Item	Symbol	Test Conditions	Criteria for Judgment	
			Min.	Max.
Luminous Intensity	I_V	$I_F=20\text{ mA}$	$\text{LSL}\times 0.7$ **	
Voltage (Forward)	V_F	$I_F=20\text{ mA}$		$\text{USL}\times 1.1$ *

(*) USL : Upper Standard Level , (**) LSL : Lower Standard Level