

Data sheet | Item number: 750-475/020-000
2-channel analog input; 0 ... 5 A AC/DC; Differential input

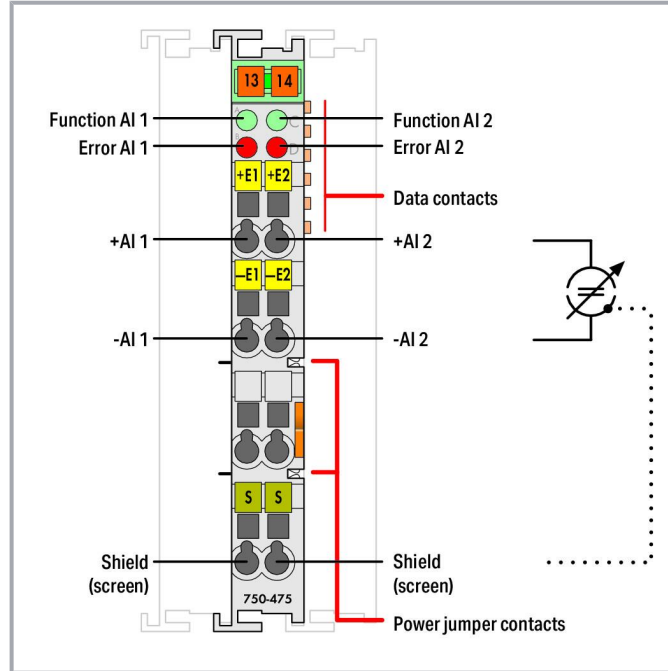

www.wago.com/750-475/020-000

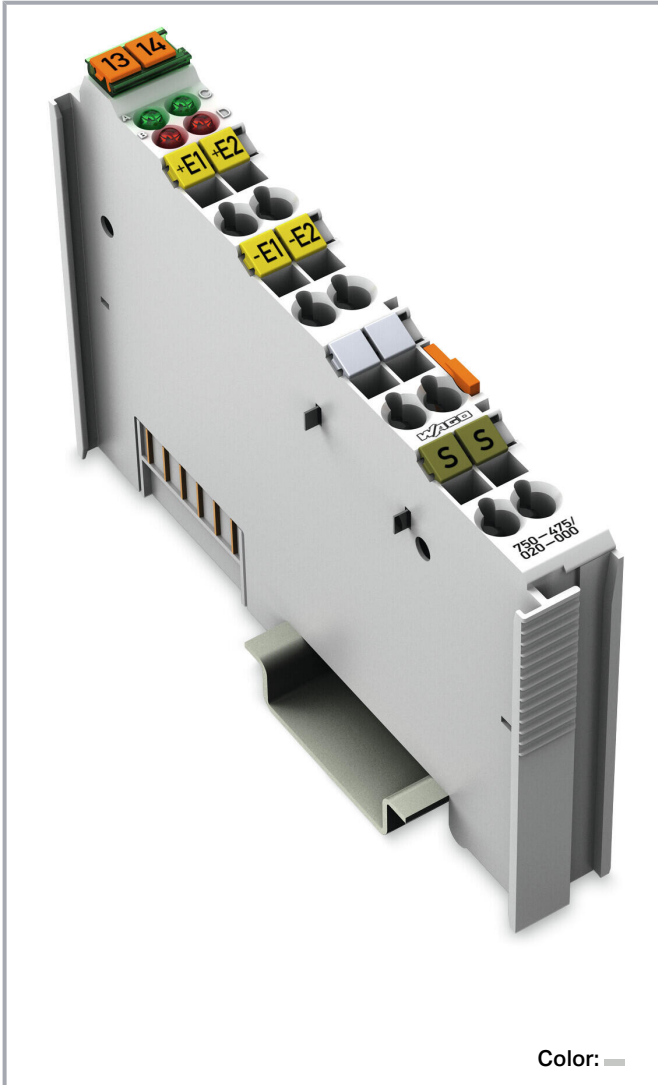

Subject to changes. Please also observe the further product documentation!

WAGO GmbH & Co. KG
Hansastr. 27
32423 Minden
Phone: +49571 887-0 | Fax: +49571 887-169
Email: info.de@wago.com | Web: www.wago.com

Do you have any questions about our products?
We are always happy to take your call at +49 (571) 887-44222.

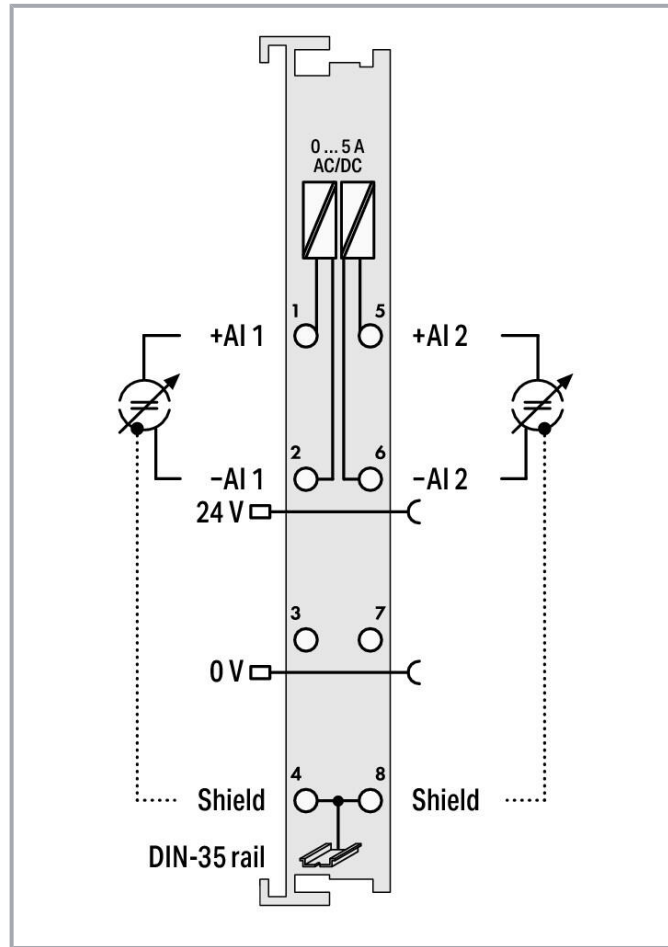
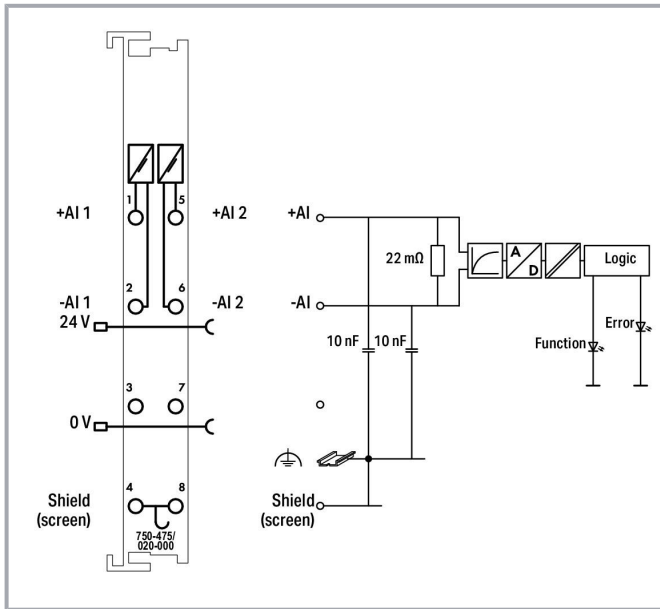

Item description

The analog input module processes AC and DC currents within a range of 0 to 5 A (rms).

The maximum current must not exceed 6 A.

The differential inputs are electrically isolated.

The fieldside and internal system are electrically isolated.

System voltage is used for voltage supply.

The input channels are differential inputs.

The shield (screen) is directly connected to the DIN rail.

Subject to changes. Please also observe the further product documentation!

WAGO GmbH & Co. KG

Hansastr. 27

32423 Minden

Phone: +49571 887-0 | Fax: +49571 887-169

Email: info.de@wago.com | Web: www.wago.com

Do you have any questions about our products?

We are always happy to take your call at +49 (571) 887-44222.

Data

Technical data

Number of analog inputs	2
Total number of channels (module)	2
Signal type	Current
Signal type (current)	0 ... 5 AAC/DC
Sensor connection	2 x (2-wire)
Input voltage (max.)	24 VAC/DC (-20 ... +20 %)
Signal characteristics	Differential
Resolution [bit]	15 bits
Input resistance (max.)	0.022 Ω
Data width	2 x 16-bit data; 2 x 8-bit control/status (optional)
Measurement error (reference temperature)	25 °C
Measurement error, deviation (max.) from the upper-range value	0.1 %
Supply voltage (system)	5 VDC; via data contacts
Current consumption (5 V system supply)	80 mA
Supply voltage (field)	24 VDC (-25 ... +30 %); via power jumper contacts (power supply via blade contact; transmission via spring contact)
Isolation	500 V system/field or channel/channel
Indicators	LED (A, C) green: Function AI 1, AI 2; LED (B, D) red: Error AI 1, AI 2
Number of incoming power jumper contacts	2
Number of outgoing power jumper contacts	2

Connection data

Connection technology: inputs/outputs	8 x CAGE CLAMP®
Connection type 1	Inputs/Outputs
Solid conductor	0.08 ... 2.5 mm ² / 28 ... 14 AWG
Fine-stranded conductor	0.08 ... 2.5 mm ² / 28 ... 14 AWG
Strip length	8 ... 9 mm / 0.31 ... 0.35 inches

Physical data

Width	12 mm / 0.472 inches
Height	100 mm / 3.937 inches
Depth	69.8 mm / 2.748 inches
Depth from upper-edge of DIN-rail	62.6 mm / 2.465 inches

Subject to changes. Please also observe the further product documentation!

Mechanical Data

Mounting type	DIN-35 rail
---------------	-------------

Material Data

Color	light gray
Housing material	Polycarbonate; polyamide 6.6
Fire load	1.32 MJ
Weight	50.9 g
Conformity marking	CE

Environmental requirements

Ambient temperature (operation)	0 ... +55 °C
Ambient temperature (storage)	-25 ... +85 °C
Protection type	IP20
Pollution degree	2 per IEC 61131-2
Operating altitude	0 ... 2000 m / 0 ... 6562 ft
Mounting position	horizontal (standing/lying); vertical
Relative humidity (without condensation)	95 %
Vibration resistance	4g per IEC 60068-2-6
Shock resistance	15g per IEC 60068-2-27
EMC immunity to interference	per EN 61000-6-2, marine applications
EMC emission of interference	per EN 61000-6-4, marine applications
Exposure to pollutants	Per IEC 60068-2-42 and IEC 60068-2-43
Permissible H ₂ S contaminant concentration at a relative humidity 75 %	10 ppm
Permissible SO ₂ contaminant concentration at a relative humidity 75 %	25 ppm

Commercial data

Product Group	15 (I/O System)
eCl@ss 10.0	27-24-26-01
eCl@ss 9.0	27-24-26-01
ETIM 8.0	EC001596
ETIM 7.0	EC001596
PU (SPU)	1 pcs
Packaging type	box

Subject to changes. Please also observe the further product documentation!





Country of origin	DE
GTIN	4045454493073
Customs tariff number	85389099990

Environmental Product Compliance



RoHS Compliance Status	Compliant, No Exemption
------------------------	-------------------------

Approvals / Certificates

General approvals

Logo	Approval	Additional Approval Text	Certificate name
	CCC CNEX	CNCA-C23-01	2020312310000213 (Ex ec IIC T4 Gc)
	EAC Brjansker Zertifizierungsstelle	TP TC 020/2011	EAC RU C-DE.AM02. B.00087/19
	KC National Radio Research Agency	Article 58-2, Clause 3	MSIP-REM-W43- AIM750
	UL Underwriters Laboratories Inc. (ORDINARY LOCATIONS)	UL 508	E175199 Sec.1

Declarations of conformity and manufacturer's declarations

Logo	Approval	Additional Approval Text	Certificate name
	EU-Declaration of Conformity WAGO GmbH & Co. KG	-	-
	UK-Declaration of Conformity WAGO GmbH & Co. KG	-	-

Approvals for marine applications

Logo	Approval	Additional Approval Text	Certificate name
	ABS American Bureau of Shipping	-	22-2219060

Subject to changes. Please also observe the further product documentation!



	BSH Bundesamt fuer Seeschifffahrt und Hydrographie	-	1104
---	--	---	------



	BV Bureau Veritas S.A.	-	30389/B1 BV
---	----------------------------------	---	-------------



	DNV DNV GL SE	DNV-CG-0339, Aug. 2021	TAA0000194
--	-------------------------	------------------------	------------



	KR Korean Register of Shipping	-	KR HMB05880-AC001
--	--	---	-------------------



	LR Lloyds Register EMEA	-	LR22180952TA
--	-----------------------------------	---	--------------





	PRS Polski Rejestr Statków	-	TE/2236/880590/19
---	--------------------------------------	---	-------------------

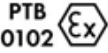

	RINA RINA Germany GmbH	-	ELE343521XG001
--	----------------------------------	---	----------------

Approvals for hazardous areas

Logo	Approval	Additional Approval Text	Certificate name
	ATEX TUEV Nord Cert GmbH	EN 60079-0	TUEV_14_ATEX_148929_X (II 3 G Ex ec IIC T4 Gc)
	CCC CNEX	CNCA-C23-01	2020312310000213 (Ex ec IIC T4 Gc)
	IECEX	IEC 60079-0	IECEX TUN 14.0035 X (Ex ec)

Subject to changes. Please also observe the further product documentation!

TUEV Nord Cert GmbH

IIC T4 Gc)



INMETRO
TÜV Rheinland do Brasil Ltda.

IEC 60079-0

BR-Ex_TÜV 12.1297 X



UKEx
WAGO GmbH & Co. KG

EN 60079-0

UKCA_WAGO22UKEX003X_ec



UL
Underwriters Laboratories Inc. (HAZARDOUS
LOCATIONS)

UL 121201

E198726 Sec.1

Optional accessories

Marking accessories

Marker carrier



Item no.: 750-103
Group marker carrier

www.wago.com/750-103

Marker

Item no.: 2009-145/000-006

Mini-WSB Inline; for Smart Printer; 1700 pieces on roll; stretchable 5 - 5.2 mm; plain; snap-on type; blue

www.wago.com/2009-145

/000-006

Item no.: 2009-145

Mini-WSB Inline; for Smart Printer; 1700 pieces on roll; stretchable 5 - 5.2 mm; plain; snap-on type; white

www.wago.com/2009-145

Item no.: 2009-145/000-002

Mini-WSB Inline; for Smart Printer; 1700 pieces on roll; stretchable 5 - 5.2 mm; plain; snap-on type; yellow

www.wago.com/2009-145

/000-002

Item no.: 2009-145/000-007

Mini-WSB Inline; for Smart Printer; 1700 pieces on roll; stretchable 5 - 5.2 mm; plain; snap-on type; gray

www.wago.com/2009-145

/000-007

Item no.: 2009-145/000-005

Mini-WSB Inline; for Smart Printer; 1700 pieces on roll; stretchable 5 - 5.2 mm; plain; snap-on type; red

www.wago.com/2009-145

/000-005

Item no.: 2009-145/000-012

Subject to changes. Please also observe the further product documentation!

WAGO GmbH & Co. KG

Hansastr. 27









32423 Minden

Phone: +49571 887-0 | Fax: +49571 887-169

Email: info.de@wago.com | Web: www.wago.com

Do you have any questions about our products?

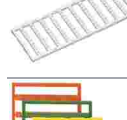
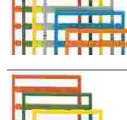
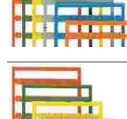
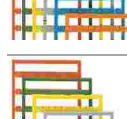
We are always happy to take your call at +49 (571) 887-44222.

	Mini-WSB Inline; for Smart Printer; 1700 pieces on roll; stretchable 5 - 5.2 mm; plain; snap-on type; orange	www.wago.com/2009-145/000-012
	Item no.: 2009-145/000-023 Mini-WSB Inline; for Smart Printer; 1700 pieces on roll; stretchable 5 - 5.2 mm; plain; snap-on type; green	www.wago.com/2009-145/000-023
	Item no.: 2009-145/000-024 Mini-WSB Inline; for Smart Printer; 1700 pieces on roll; stretchable 5 - 5.2 mm; plain; snap-on type; violet	www.wago.com/2009-145/000-024
	Item no.: 248-501/000-006 Mini-WSB marking card; as card; not stretchable; plain; snap-on type; blue	www.wago.com/248-501/000-006
	Item no.: 248-501/000-007 Mini-WSB marking card; as card; not stretchable; plain; snap-on type; gray	www.wago.com/248-501/000-007
	Item no.: 248-501/000-002 Mini-WSB marking card; as card; not stretchable; plain; snap-on type; yellow	www.wago.com/248-501/000-002
	Item no.: 248-501/000-012 Mini-WSB marking card; as card; not stretchable; plain; snap-on type; orange	www.wago.com/248-501/000-012
	Item no.: 248-501 Mini-WSB marking card; as card; not stretchable; plain; snap-on type; white	www.wago.com/248-501
	Item no.: 248-501/000-017 Mini-WSB marking card; as card; not stretchable; plain; snap-on type; light green	www.wago.com/248-501/000-017
	Item no.: 248-501/000-005 Mini-WSB marking card; as card; not stretchable; plain; snap-on type; red	www.wago.com/248-501/000-005
	Item no.: 248-501/000-024 Mini-WSB marking card; as card; not stretchable; plain; snap-on type; violet	www.wago.com/248-501/000-024
	Item no.: 248-501/000-023 Mini-WSB marking card; as card; not stretchable; plain; snap-on type; green	www.wago.com/248-501/000-023

Subject to changes. Please also observe the further product documentation!



Item no.: 750-100
Marker card; as a DIN A4 sheet; plain

www.wago.com/750-100

Group marker carrier



Item no.: 750-106
Group marker carrier

www.wago.com/750-106

Carrier rail

Mounting accessories



Item no.: 210-197
Steel carrier rail; 35 x 15 mm; 1.5 mm thick; 2 m long; slotted; similar to EN 60715; silver-colored

www.wago.com/210-197



Item no.: 210-198
Copper carrier rail; 35 x 15 mm; 2.3 mm thick; 2 m long; unslotted; according to EN 60715; copper-colored

www.wago.com/210-198



Item no.: 210-504
Steel carrier rail; 35 x 7.5 mm; 1 mm thick; 2 m long; slotted; galvanized; according to EN 60715; silver-colored

www.wago.com/210-504



Item no.: 210-505
Steel carrier rail; 35 x 7.5 mm; 1 mm thick; 2 m long; unslotted; galvanized; according to EN 60715; silver-colored

www.wago.com/210-505



Item no.: 210-506
Steel carrier rail; 35 x 15 mm; 1.5 mm thick; 2 m long; unslotted; galvanized; similar to EN 60715; silver-colored

www.wago.com/210-506



Item no.: 210-508
Steel carrier rail; 35 x 15 mm; 1.5 mm thick; 2 m long; slotted; galvanized; similar to EN 60715; silver-colored

www.wago.com/210-508



Item no.: 210-113
Steel carrier rail; 35 x 7.5 mm; 1 mm thick; 2 m long; unslotted; according to EN 60715; silver-colored

www.wago.com/210-113

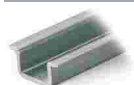

Item no.: 210-118
Steel carrier rail; 35 x 15 mm; 2.3 mm thick; 2 m long; unslotted; according to EN 60715; silver-colored

www.wago.com/210-118



Item no.: 210-112
Steel carrier rail; 35 x 7.5 mm; 1 mm thick; 2 m long; slotted; according to EN 60715; "Hole width 25 mm; silver-colored

www.wago.com/210-112



Item no.: 210-114
Steel carrier rail; 35 x 15 mm; 1.5 mm thick; 2 m long; unslotted; similar to EN 60715; silver-colored

www.wago.com/210-114



Item no.: 210-115
Steel carrier rail; 35 x 7.5 mm; 1 mm thick; 2 m long; slotted; according to EN 60715; "Hole width 18 mm; silver-colored

www.wago.com/210-115

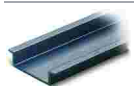

Item no.: 210-196
Aluminum carrier rail; 35 x 8.2 mm; 1.6 mm thick; 2 m long; unslotted; similar to EN 60715; silver-colored

www.wago.com/210-196

Subject to changes. Please also observe the further product documentation!

WAGO GmbH & Co. KG

Hansastr. 27

32423 Minden











Phone: +49571 887-0 | Fax: +49571 887-169

Email: info.de@wago.com | Web: www.wago.com

Do you have any questions about our products?

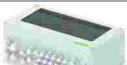
We are always happy to take your call at +49 (571) 887-44222.

System housing

System enclosure		
	Item no.: 850-814/002-000 IP65 enclosure; Sheet steel (RAL 7035); WxHxD (200x120x200 mm); without flange plate	www.wago.com/850-814/002-000
	Item no.: 850-815/002-000 IP65 enclosure; Sheet steel (RAL 7035); WxHxD (300x120x200 mm); without flange plate	www.wago.com/850-815/002-000
	Item no.: 850-816/002-000 IP65 enclosure; Sheet steel (RAL 7035); WxHxD (400x120x200 mm); without flange plate	www.wago.com/850-816/002-000
	Item no.: 850-817/002-000 IP65 enclosure; Sheet steel (RAL 7035); WxHxD (600x120x200 mm); without flange plate	www.wago.com/850-817/002-000
	Item no.: 850-825 IP65 enclosure; Aluminium (RAL 7032); WxHxD (160x100x160 mm); 9 x M12, 4 x M20	www.wago.com/850-825
	Item no.: 850-826 IP65 enclosure; Aluminium (RAL 7032); WxHxD (240x100x160 mm); 4 x M20, 4 x M16, 14 x M12 cable grip	www.wago.com/850-826
	Item no.: 850-827 IP65 enclosure; Aluminium (RAL 7032); WxHxD (320x100x160 mm); 4 x M20, 8 x M16, 17 x M12 cable grip	www.wago.com/850-827
	Item no.: 850-827/002-000 IP65 enclosure; Aluminium (RAL 7035); WxHxD (320x100x160 mm); 4 x M20, 8 x M16, 17 x M12 cable grip	www.wago.com/850-827/002-000
	Item no.: 850-826/002-000 IP65 enclosure; Aluminium (RAL 7035); WxHxD (240x100x160 mm); 4 x M20, 4 x M16, 14 x M12 cable grip	www.wago.com/850-826/002-000
	Item no.: 850-828/002-000 IP65 enclosure; Aluminium (RAL 7035); WxHxD (480x100x160 mm); 4 x M20, 10 x M16, 35 x M12 cable grip	www.wago.com/850-828/002-000
	Item no.: 850-828 IP65 enclosure; Aluminium (RAL 7032); WxHxD (480x100x160 mm); 4 x M20, 10 x M16, 35 x M12 cable grip	www.wago.com/850-828
	Item no.: 850-834 IP65 enclosure; Polyester (RAL 7032); WxHxD (164x100x164 mm); 9 x M12, 4 x M20	www.wago.com/850-834
	Item no.: 850-835 IP65 enclosure; Polyester (RAL 7032); WxHxD (244x100x164 mm); 4 x M20, 4 x M16, 14 x M12 cable grip	www.wago.com/850-835
	Item no.: 850-836	

Subject to changes. Please also observe the further product documentation!









IP65 enclosure; Polyester (RAL 7032); WxHxD (324x100x164 mm); 4 x M20, 8 x M16, 17 x M12 cable grip

www.wago.com/850-836

Shield termination

Shield clamping saddles

	Item no.: 790-116 Shield clamping saddle; 19 mm wide; diameter of compatible conductor; 7 ... 16 mm	www.wago.com/790-116
	Item no.: 790-124 Shield clamping saddle; 27 mm wide; diameter of compatible conductor; 6 ... 24 mm	www.wago.com/790-124
	Item no.: 790-108 Shield clamping saddle; 11 mm wide; diameter of compatible conductor; 3 ... 8 mm	www.wago.com/790-108
	Item no.: 790-140 Shield clamping saddle; diameter of compatible conductor	www.wago.com/790-140
	Item no.: 790-216 Shield clamping saddle; 21.8 mm wide; 6 ... 16 mm	www.wago.com/790-216
	Item no.: 790-220 Shield clamping saddle; 30 mm wide; 6 ... 20 mm	www.wago.com/790-220
	Item no.: 790-208 Shield clamping saddle; 12.4 mm wide; 3 ... 8 mm	www.wago.com/790-208

Downloads

Documentation

Manual

System Manual WAGO I/O System 750/753 Decentralized Automation Technology	V 3.3.0 2023 May 4	pdf 8.8 MB	Download
Product Manual 2-channel, 0-5A AC/DC, diff.	V 1.1.0	pdf 2.1 MB	Download
System Manual Series 750/753 Online HTML		URL	Download

Bid Text

750-475/020-000 X81 - Datei	2019 Feb 19	xml 4.8 kB	Download
750-475/020-000 doc - Datei	2017 Oct 17	doc 30.2 kB	Download

Subject to changes. Please also observe the further product documentation!

WAGO GmbH & Co. KG
Hansastr. 27
32423 Minden
Phone: +49571 887-0 | Fax: +49571 887-169
Email: info.de@wago.com | Web: www.wago.com

Do you have any questions about our products?
We are always happy to take your call at +49 (571) 887-44222.



Instruction Leaflet

CCC Ex (Additional information) WAGO-I/O-SYSTEM *750-****/*	2023 Apr 26	pdf 163.6 kB	Download
--	-------------	-----------------	----------

System Description

750/753 Series I/O-System – General Product Information		pdf 1.7 MB	Download
Overview on WAGO-I/O-SYSTEM 750 approvals		pdf 789.0 kB	Download

Additional Information

Disposal and Recycling Electrical and electronic equipment, Batteries, Packaging	V 1.1.0 2022 Aug 18	pdf 2.2 MB	Download
---	------------------------	---------------	----------

CAD/CAE-Data

CAD data

2D/3D Models 750-475/020-000		URL	Download
------------------------------	--	-----	----------

CAE data

EPLAN Data Portal 750-475/020-000		URL	Download
WSCAD Universe 750-475/020-000		URL	Download
ZUKEN Portal 750-475/020-000		URL	Download
EPLAN Data Portal 750-475/020-000		URL	Download
WSCAD Universe 750-475/020-000		URL	Download

Device Files

Device Driver

WAGO USB Service Kabel Treiber / Serie 750 und 857	6.5.3.0 2014 Sep 10	zip 4.8 MB	Download
--	------------------------	---------------	----------

Subject to changes. Please also observe the further product documentation!



Environmental Product Compliance

Compliance Search

Environmental Product Compliance 750-475/020-000

[URL](#)

[Download](#)

2-channel analog input; 0 ... 5 A AC/DC; Differential input

Installation Notes

Product family

WAGO I/O System 750/753

[Show all products from the family](#)

Subject to changes. Please also observe the further product documentation!

WAGO GmbH & Co. KG

Hansastr. 27

32423 Minden

Phone: +49571 887-0 | Fax: +49571 887-169

Email: info.de@wago.com | Web: www.wago.com

Do you have any questions about our products?

We are always happy to take your call at +49 (571) 887-44222.