

Data sheet | Item number: 2022-1604

2-pin carrier terminal block; for DIN-rail 35 x 15 and 35 x 7.5; blue

www.wago.com/2022-1604

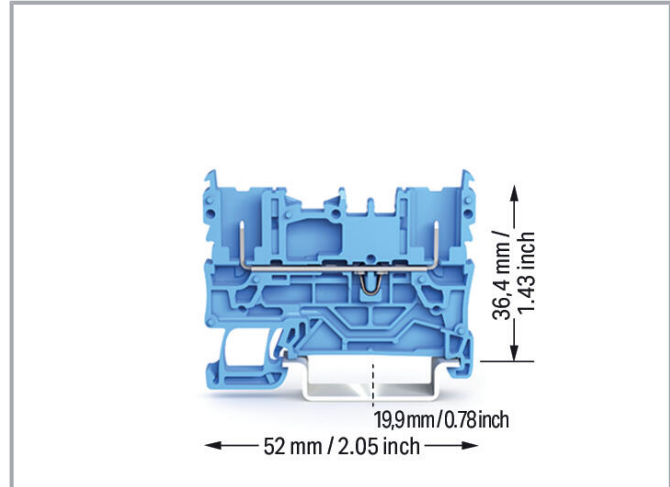
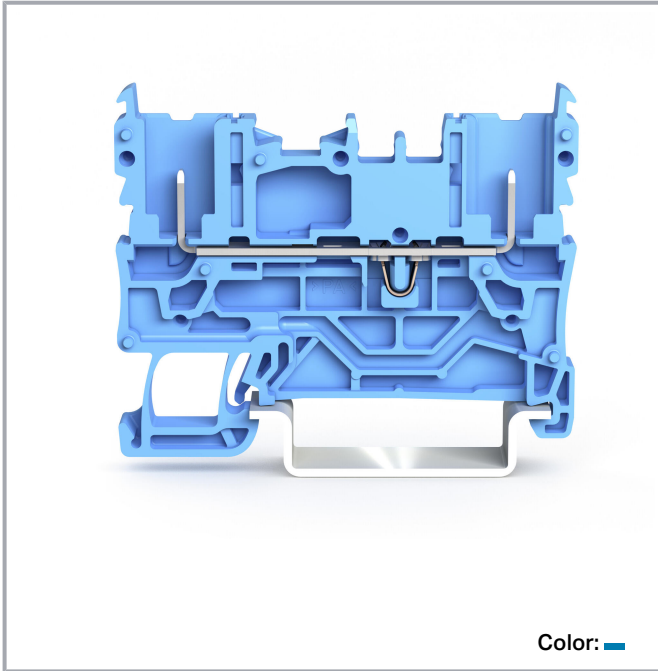

Data

Electrical data

Ratings per IEC/EN

| Ratings per | IEC/EN 60947-7-1 |
|-------------------------------|---|
| Nominal voltage (III/3) | 690 V |
| Rated impulse voltage (III/3) | 6 kV |
| Rated current | 24 A |
| Rated current 2 | 28 A |
| Legend (ratings) | (III / 3) ≙ Overvoltage category III / Pollution degree 3 |

Ratings per UL 1059

| | |
|--------------------------------|---------|
| Approvals per | UL 1059 |
| Rated voltage UL (Use Group B) | 600 V |
| Rated current UL (Use Group B) | 20 A |

Subject to changes. Please also observe the further product documentation!

WAGO GmbH & Co. KG
Hansastr. 27
32423 Minden
Phone: +49571 887-0 | Fax: +49571 887-169
Email: info.de@wago.com | Web: www.wago.com

Do you have any questions about our products?
We are always happy to take your call at +49 (571) 887-44222.



| | |
|--------------------------------|-------|
| Rated voltage UL (Use Group C) | 600 V |
| Rated current UL (Use Group C) | 20 A |

Ratings per CSA

| | |
|---------------------------------|-----------------|
| Approvals per | CSA 22.2 No 158 |
| Rated voltage CSA (Use Group C) | 600 V |
| Rated current CSA (Use Group C) | 20 A |

Power loss

| | |
|--|---------|
| Power loss, per pole (potential) | 0.766 W |
| Rated current I_N for specified power loss | 24 A |

Connection data

| | |
|----------------------------|---|
| Female plug slots | 2 |
| Total number of potentials | 1 |
| Number of levels | 1 |

Physical data

| | |
|-----------------------------------|-----------------------|
| Width | 5.2 mm / 0.205 inches |
| Height | 52 mm / 2.047 inches |
| Depth from upper-edge of DIN-rail | 32.5 mm / 1.28 inches |

Mechanical Data

| | |
|---------------|----------------------------|
| Design | horizontal type |
| Mounting type | DIN-35 rail DIN-35 rail |
| Marking level | Center/side marking |

Material Data

| | |
|-----------------------------|--|
| Note (material data) | Information on material specifications can be found here |
| Color | blue |
| Material group | I |
| Insulation material | Polyamide (PA66) |
| Flammability class per UL94 | V0 |

Subject to changes. Please also observe the further product documentation!

| | |
|-----------|----------|
| Fire load | 0.125 MJ |
| Weight | 5.5 g |

Environmental requirements

| | |
|----------------------------------|-----------------|
| Processing temperature | -35 ... +85 °C |
| Continuous operating temperature | -60 ... +105 °C |

Commercial data



| | |
|-----------------------|---------------|
| ETIM 8.0 | EC000897 |
| ETIM 7.0 | EC000897 |
| PU (SPU) | 50 pcs |
| Packaging type | Box |
| Country of origin | CN |
| GTIN | 4055143828857 |
| Customs tariff number | 85366990990 |

Environmental Product Compliance

| | |
|------------------------|-------------------------|
| RoHS Compliance Status | Compliant, No Exemption |
|------------------------|-------------------------|



Approvals / Certificates

General approvals

| Logo | Approval | Additional Approval Text | Certificate name |
|--|---------------------------------------|--------------------------|--------------------|
|  | CCA DEKRA Certification B.V. | C22.2 No. 158 | 2437422 |
|  | CCA DEKRA Certification B.V. | EN 60947 | NTR CCA NL-7864 |
|  | KEMA/KEUR DEKRA Certification B.V. | EN 60947 | 71- 116567 |
|  | UL Underwriters Laboratories Inc. | UL 1059 | E45172 |



Subject to changes. Please also observe the further product documentation!

Counterpart

| | | |
|---|---|--|
|  | Item no.2022-101/000-006 1-conductor female connector; Push-in CAGE CLAMP®; 4 mm ² ; Pin spacing 5.2 mm; 1-pole; 4,00 mm ² ; blue | www.wago.com/2022-101/000-006 |
|  | Item no.2022-101 1-conductor female connector; Push-in CAGE CLAMP®; 4 mm ² ; Pin spacing 5.2 mm; 1-pole; 4,00 mm ² ; gray | www.wago.com/2022-101 |





Required accessories

End plate

| | | |
|--|---|--|
| End plate | | |
|  | Item no.: 2022-1691 End plate; 1 mm thick; gray | www.wago.com/2022-1691 |
|  | Item no.: 2022-1692 End plate; 1 mm thick; orange | www.wago.com/2022-1692 |

Optional accessories

Push-in type wire jumper

| | | |
|--|--|--|
| Jumper | | |
|  | Item no.: 2009-412 Push-in type wire jumper; insulated; 60 mm long; black | www.wago.com/2009-412 |
|  | Item no.: 2009-414 Push-in type wire jumper; 1.5 mm ² ; insulated; 110 mm long; black | www.wago.com/2009-414 |
|  | Item no.: 2009-416 Push-in type wire jumper; 1.5 mm ² ; insulated; 250 mm long; black | www.wago.com/2009-416 |
|  | Item no.: 2009-414/000-005 Push-in type wire jumper; 1.5 mm ² ; insulated; 110 mm long; black | www.wago.com/2009-414/000-005 |
|  | Item no.: 2009-414/000-006 Push-in type wire jumper; insulated; 110 mm long; black | www.wago.com/2009-414/000-006 |







Coding

| | | |
|--|---|--|
| Coding | | |
|  | Item no.: 2022-100 Carrier with 6 coding pins; for coding of female plugs; orange | www.wago.com/2022-100 |

Subject to changes. Please also observe the further product documentation!

Carrier rail

Mounting accessories

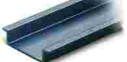
| | | |
|--|--|--|
|  | Item no.: 210-197 Steel carrier rail; 35 x 15 mm; 1.5 mm thick; 2 m long; slotted; similar to EN 60715; silver-colored | www.wago.com/210-197 |
|  | Item no.: 210-198 Copper carrier rail; 35 x 15 mm; 2.3 mm thick; 2 m long; unslotted; according to EN 60715; copper-colored | www.wago.com/210-198 |
|  | Item no.: 210-113 Steel carrier rail; 35 x 7.5 mm; 1 mm thick; 2 m long; unslotted; according to EN 60715; silver-colored | www.wago.com/210-113 |
|  | Item no.: 210-118 Steel carrier rail; 35 x 15 mm; 2.3 mm thick; 2 m long; unslotted; according to EN 60715; silver-colored | www.wago.com/210-118 |
|  | Item no.: 210-112 Steel carrier rail; 35 x 7.5 mm; 1 mm thick; 2 m long; slotted; according to EN 60715; "Hole width 25 mm; silver-colored | www.wago.com/210-112 |
|  | Item no.: 210-114 Steel carrier rail; 35 x 15 mm; 1.5 mm thick; 2 m long; unslotted; similar to EN 60715; silver-colored | www.wago.com/210-114 |
|  | Item no.: 210-115 Steel carrier rail; 35 x 7.5 mm; 1 mm thick; 2 m long; slotted; according to EN 60715; "Hole width 18 mm; silver-colored | www.wago.com/210-115 |
|  | Item no.: 210-196 Aluminum carrier rail; 35 x 8.2 mm; 1.6 mm thick; 2 m long; unslotted; similar to EN 60715; silver-colored | www.wago.com/210-196 |

Jumpers

Jumper

| | | |
|--|--|--|
|  | Item no.: 2002-402 Jumper; 2-way; insulated; light gray | www.wago.com/2002-402 |
|  | Item no.: 2002-402/000-005 Jumper; 2-way; insulated; red | www.wago.com/2002-402/000-005 |
|  | Item no.: 2002-400 Continuous jumper; 2-way; insulated; light gray | www.wago.com/2002-400 |
|  | Item no.: 2002-403 Jumper; 3-way; insulated; light gray | www.wago.com/2002-403 |
|  | Item no.: 2002-404/000-005 Jumper; 4-way; insulated; red | www.wago.com/2002-404/000-005 |
|  | Item no.: 2002-403/000-006 Jumper; 3-way; insulated; blue | www.wago.com/2002-403/000-006 |

Subject to changes. Please also observe the further product documentation!



Item no.: 2002-404/000-006
Jumper; 4-way; insulated; blue

www.wago.com/2002-404/000-006



Item no.: 2002-403/000-005
Jumper; 3-way; insulated; red

www.wago.com/2002-403/000-005



Item no.: 2002-405/000-005
Jumper; 5-way; insulated; red

www.wago.com/2002-405/000-005



Item no.: 2002-402/000-006
Jumper; 2-way; insulated; blue

www.wago.com/2002-402/000-006



Item no.: 2002-405/000-006
Jumper; 5-way; insulated; blue

www.wago.com/2002-405/000-006



Item no.: 2002-404
Jumper; 4-way; insulated; light gray

www.wago.com/2002-404



Item no.: 2002-406/000-006
Jumper; 6-way; insulated; blue

www.wago.com/2002-406/000-006



Item no.: 2002-406/000-005
Jumper; 6-way; insulated; red

www.wago.com/2002-406/000-005



Item no.: 2002-406/020-000
Delta jumper; insulated; light gray

www.wago.com/2002-406/020-000



Item no.: 2002-405
Jumper; 5-way; insulated; light gray

www.wago.com/2002-405



Item no.: 2002-407/000-005
Jumper; 7-way; insulated; red

www.wago.com/2002-407/000-005



Item no.: 2002-408
Jumper; 8-way; insulated; light gray

www.wago.com/2002-408

Subject to changes. Please also observe the further product documentation!



Item no.: 2002-408/000-006
Jumper; 8-way; insulated; blue

www.wago.com/2002-408/000-006



Item no.: 2002-405/011-000
Star point jumper; 3-way; insulated; light gray

www.wago.com/2002-405/011-000



Item no.: 2002-407/000-006
Jumper; 7-way; insulated; blue

www.wago.com/2002-407/000-006



Item no.: 2002-408/000-005
Jumper; 8-way; insulated; red

www.wago.com/2002-408/000-005



Item no.: 2002-407
Jumper; 7-way; insulated; light gray

www.wago.com/2002-407



Item no.: 2002-406
Jumper; 6-way; insulated; light gray

www.wago.com/2002-406



Item no.: 2002-410/000-005
Jumper; 10-way; insulated; red

www.wago.com/2002-410/000-005



Item no.: 2002-410/000-006
Jumper; 10-way; insulated; blue

www.wago.com/2002-410/000-006



Item no.: 2002-410
Jumper; 10-way; insulated; light gray

www.wago.com/2002-410



Item no.: 2002-409/000-006
Jumper; 9-way; insulated; blue

www.wago.com/2002-409/000-006



Item no.: 2002-409/000-005
Jumper; 9-way; insulated; red

www.wago.com/2002-409/000-005



















Item no.: 2002-409
Jumper; 9-way; insulated; light gray











www.wago.com/2002-409

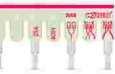

Subject to changes. Please also observe the further product documentation!

| | | |
|--|--|---|
| | <p>Item no.: 2002-423/000-006 Continuous jumper; from 1 to 3; insulated; blue</p> | <p>www.wago.com/2002-423/000-006</p> |
|  | <p>Item no.: 2002-423 Continuous jumper; from 1 to 3; insulated; light gray</p> | <p>www.wago.com/2002-423</p> |
|  | <p>Item no.: 2002-433 Jumper; from 1 to 3; insulated; light gray</p> | <p>www.wago.com/2002-433</p> |
|  | <p>Item no.: 2002-434 Jumper; from 1 to 4; insulated; light gray</p> | <p>www.wago.com/2002-434</p> |
|  | <p>Item no.: 2002-423/000-005 Continuous jumper; from 1 to 3; insulated; red</p> | <p>www.wago.com/2002-423/000-005</p> |
|  | <p>Item no.: 2002-435 Jumper; from 1 to 5; insulated; light gray</p> | <p>www.wago.com/2002-435</p> |
|  | <p>Item no.: 2002-436 Jumper; from 1 to 6; insulated; light gray</p> | <p>www.wago.com/2002-436</p> |
|  | <p>Item no.: 2002-437 Jumper; from 1 to 7; insulated; light gray</p> | <p>www.wago.com/2002-437</p> |
|  | <p>Item no.: 2002-438 Jumper; from 1 to 8; insulated; light gray</p> | <p>www.wago.com/2002-438</p> |
|  | <p>Item no.: 2002-439 Jumper; from 1 to 9; insulated; light gray</p> | <p>www.wago.com/2002-439</p> |
|  | <p>Item no.: 2002-440 Jumper; from 1 to 10; insulated; light gray</p> | <p>www.wago.com/2002-440</p> |
|  | <p>Item no.: 2002-472 Staggered jumper; 2-way; insulated; light gray</p> | <p>www.wago.com/2002-472</p> |
|  | <p>Item no.: 2002-473 Staggered jumper; 3-way; insulated; light gray</p> | <p>www.wago.com/2002-473</p> |
|  | <p>Item no.: 2002-475/011-000 Staggered jumper; 3-way; insulated; light gray</p> | <p>www.wago.com/2002-475/011-000</p> |
|  | <p>Item no.: 2002-475 Staggered jumper; 5-way; insulated; light gray</p> | <p>www.wago.com/2002-475</p> |
|  | <p>Item no.: 2002-476 Staggered jumper; 6-way; insulated; light gray</p> | <p>www.wago.com/2002-476</p> |
|  | <p>Item no.: 2002-474 Staggered jumper; 4-way; insulated; light gray</p> | <p>www.wago.com/2002-474</p> |

Subject to changes. Please also observe the further product documentation!



| | | |
|---|--|--|
|  | Item no.: 2002-477 Staggered jumper; 7-way; insulated; light gray | www.wago.com/2002-477 |
|  | Item no.: 2002-473/011-000 Staggered jumper; 2-way; from 1 to 3; insulated; light gray | www.wago.com/2002-473/011-000 |
|  | Item no.: 2002-479 Staggered jumper; 9-way; insulated; light gray | www.wago.com/2002-479 |
|  | Item no.: 2002-478 Staggered jumper; 8-way; insulated; light gray | www.wago.com/2002-478 |
|  | Item no.: 2002-479/011-000 Staggered jumper; insulated; light gray | www.wago.com/2002-479/011-000 |
|  | Item no.: 2002-480 Staggered jumper; 10-way; insulated; light gray | www.wago.com/2002-480 |
|  | Item no.: 2002-477/011-000 Staggered jumper; insulated; light gray | www.wago.com/2002-477/011-000 |
|  | Item no.: 2002-481/011-000 Staggered jumper; insulated; light gray | www.wago.com/2002-481/011-000 |
|  | Item no.: 2002-481 Staggered jumper; 11-way; insulated; light gray | www.wago.com/2002-481 |
|  | Item no.: 2002-482 Staggered jumper; 12-way; insulated; light gray | www.wago.com/2002-482 |
|  | Item no.: 2002-424/000-006 Continuous jumper; from 1 to 4; insulated; blue | www.wago.com/2002-424/000-006 |

Marking accessories









Marking strip

| | | |
|--|--|--|
|  | Item no.: 2009-110 Marking strips; for Smart Printer; on reel; not stretchable; plain; snap-on type; white | www.wago.com/2009-110 |
|--|--|--|

Marker carrier

| | | |
|--|--|--|
|  | Item no.: 2009-198 Adaptor; gray | www.wago.com/2009-198 |
|  | Item no.: 2002-161 Adaptor; gray | www.wago.com/2002-161 |

Subject to changes. Please also observe the further product documentation!

| Marker | | |
|--|--|--|
|  | Item no.: 2009-145 Mini-WSB Inline; for Smart Printer; 1700 pieces on roll; stretchable 5 - 5.2 mm; plain; snap-on type; white | www.wago.com/2009-145 |
|  | Item no.: 2009-115 WMB-Inline; for Smart Printer; 1500 pieces on roll; stretchable 5 - 5.2 mm; plain; snap-on type; white | www.wago.com/2009-115 |
|  | Item no.: 248-501 Mini-WSB marking card; as card; not stretchable; plain; snap-on type; white | www.wago.com/248-501 |
|  | Item no.: 793-5501 WMB marking card; as card; for terminal block width 5 - 17.5 mm; stretchable 5 - 5.2 mm; plain; snap-on type; white | www.wago.com/793-5501 |
| Group marker carrier | | |
|  | Item no.: 2009-193 Group marker carrier; gray | www.wago.com/2009-193 |
|  | Item no.: 2009-192 Group marker carrier; gray | www.wago.com/2009-192 |
|  | Item no.: 2009-191 Group marker carrier; gray | www.wago.com/2009-191 |
| Tool | | |
| Operating tool | | |
|  | Item no.: 210-720 Operating tool; Blade: 3.5 x 0.5 mm; with a partially insulated shaft; multicoloured | www.wago.com/210-720 |

Downloads

Documentation

Bid Text

| | | | |
|---------------------------|-------------|-----------------|----------|
| 2022-1604 X81 - Datei | 2019 May 20 | xml 4.4 kB | Download |
| 2022-1604 docx - Datei | 2019 May 20 | docx 15.6 kB | Download |

Additional Information

| | | |
|---|---------------|----------|
| Technical Section Technical explanations | pdf 2.2 MB | Download |
|---|---------------|----------|

Subject to changes. Please also observe the further product documentation!

WAGO GmbH & Co. KG
 Hansastr. 27
 32423 Minden
 Phone: +49571 887-0 | Fax: +49571 887-169
 Email: info.de@wago.com | Web: www.wago.com

Do you have any questions about our products?
 We are always happy to take your call at +49 (571) 887-44222.

CAD/CAE-Data

CAD data

| | | |
|------------------------|---------------------|--------------------------|
| 2D/3D Models 2022-1604 | URL | Download |
|------------------------|---------------------|--------------------------|

CAE data

| | | |
|------------------------|---------------------|--------------------------|
| ZUKEN Portal 2022-1604 | URL | Download |
|------------------------|---------------------|--------------------------|

Environmental Product Compliance

Compliance Search

| | | |
|--|---------------------|--------------------------|
| Environmental Product Compliance 2022-1604 | URL | Download |
|--|---------------------|--------------------------|

2-pin carrier terminal block; for DIN-rail 35 x 15 and 35 x 7.5; blue

Installation Notes

Installation

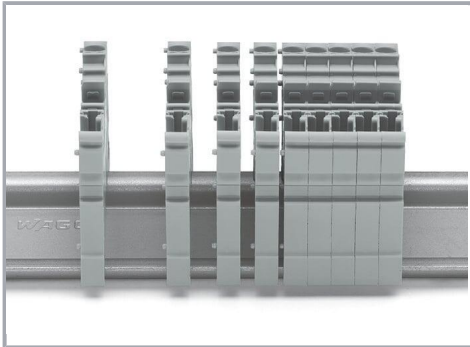

Snap individual carrier terminal blocks onto the DIN-rail and slide together.

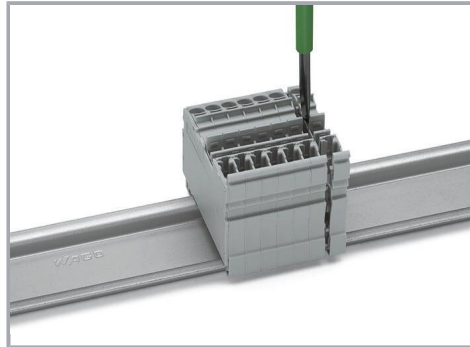

Open the assembly by laterally sliding a block via operating tool (3.5 x 0.5 mm blade).

Subject to changes. Please also observe the further product documentation!

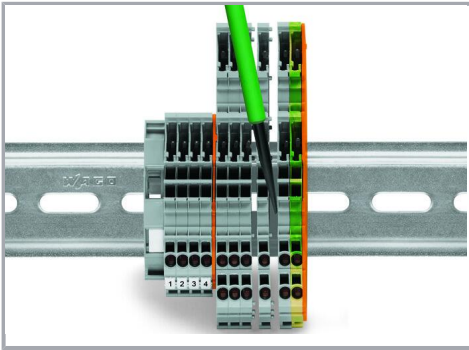

Separate terminal block assembly and slide individual terminal blocks laterally using an operating tool.

Commoning

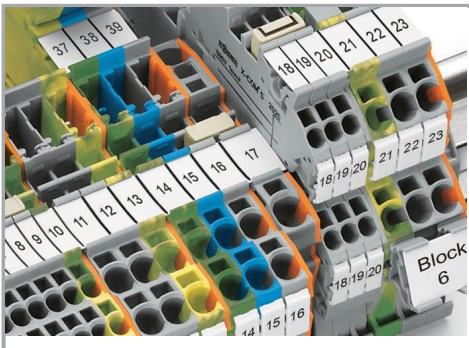

Commoning X-COM®S-SYSTEM Terminal Blocks using jumpers for TOPJOB® S Terminal Blocks. An end plate provides connection to TOPJOB® S Terminal Blocks. 2020 and 2022 Series Terminal Blocks are combinable. Jumper slots are on the same level for both series.

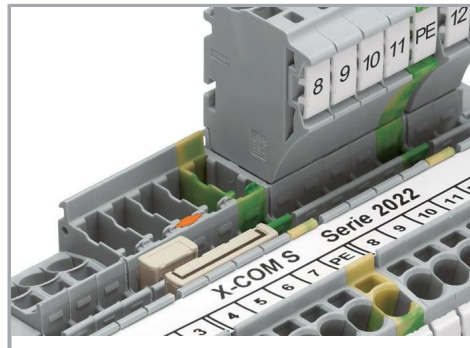

Pairing push-in comb style jumpers.

Subject to changes. Please also observe the further product documentation!

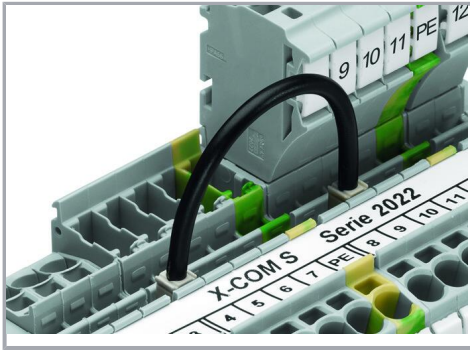

Commoning with push-in type wire jumper.

Testing

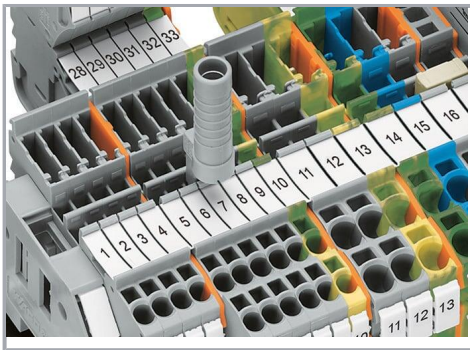

Test plug adapter (2009-174) for 4 mm test plugs or banana plugs – also suitable for X-COM®S-SYSTEM-MINI Terminal Blocks.

Coding

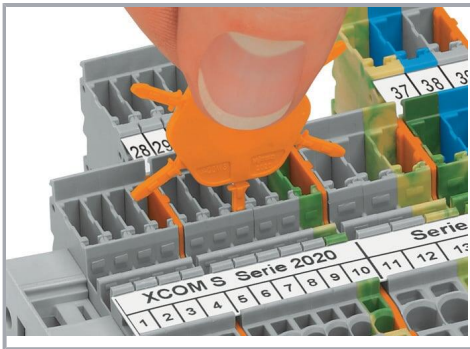

Insert coding pin into the corresponding slot and twist it off.

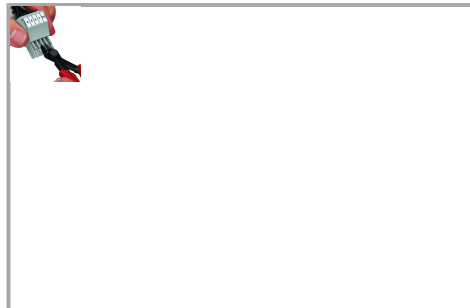

Coding a female plug: remove coding finger using a suitable tool.

Subject to changes. Please also observe the further product documentation!



Insert a coding pin (2022-100) into the corresponding location of the carrier terminal block.

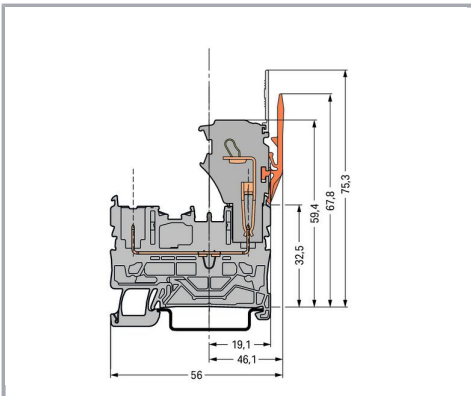

Marking

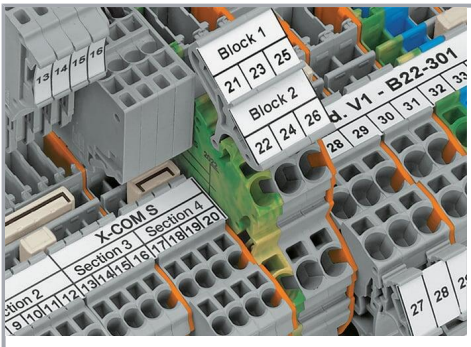

Clear marking via large marking area

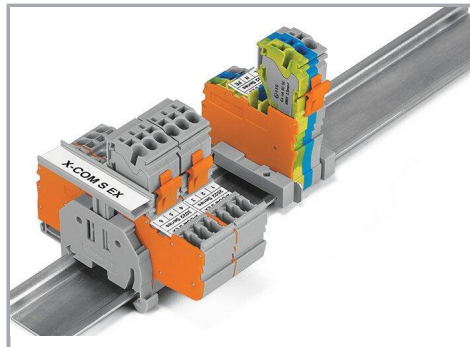

Group marking with height-adjustable group marker carrier (2009-163)

Security

Subject to changes. Please also observe the further product documentation!

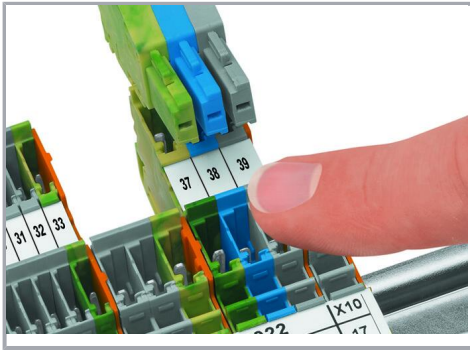

Carrier terminal blocks and female plugs are touch-proof.

Product family

X-COM S

[Show all products from the family](#)

Subject to changes. Please also observe the further product documentation!