

# Printed-circuit board connector - MCV 1,5/18-G-3,5 - 1843761

Please be informed that the data shown in this PDF Document is generated from our Online Catalog. Please find the complete data in the user's documentation. Our General Terms of Use for Downloads are valid (<http://phoenixcontact.com/download>)

PCB headers, nominal current: 8 A, number of positions: 18, pitch: 3.5 mm, color: green, contact surface: Tin, mounting: Wave soldering



The figure shows a 10-position version of the product

## Your advantages

- ✓ Well-known mounting principle allows worldwide use
- ✓ Vertical connection enables multi-row arrangement on the PCB
- ✓ Maximum flexibility when it comes to device design – one header for connectors with different connection technologies



## Key Commercial Data

Packing unit	50 pc
GTIN	 4 017918 102432
GTIN	4017918102432

## Technical data

### Dimensions

Length [ l ]	7.25 mm
Width	64.4 mm
Pitch	3.5 mm
Dimension a	59.5 mm
Width [ w ]	64.4 mm
Height [ h ]	12.6 mm
Height	9.2 mm
Length of the solder pin	3.4 mm
Pin dimensions	0.8 x 0.8 mm
Length	7.25 mm

### General

# Printed-circuit board connector - MCV 1,5/18-G-3,5 - 1843761

## Technical data

### General

Range of articles	MCV 1,5/...-G
Insulating material group	IIIa
Rated surge voltage (III/3)	2.5 kV
Rated surge voltage (III/2)	2.5 kV
Rated surge voltage (II/2)	2.5 kV
Rated voltage (III/3)	160 V
Rated voltage (III/2)	160 V
Rated voltage (II/2)	250 V
Connection in acc. with standard	EN-VDE
Nominal current $I_N$	8 A
Maximum load current	8 A
Insulating material	PBT
Flammability rating according to UL 94	V0
Color	green
Number of positions	18

### Standards and Regulations

Connection in acc. with standard	EN-VDE
	CSA
Flammability rating according to UL 94	V0

### Environmental Product Compliance

China RoHS	Environmentally friendly use period: unlimited = EFUP-e
	No hazardous substances above threshold values

## Drawings

# Printed-circuit board connector - MCV 1,5/18-G-3,5 - 1843761

Drilling diagram

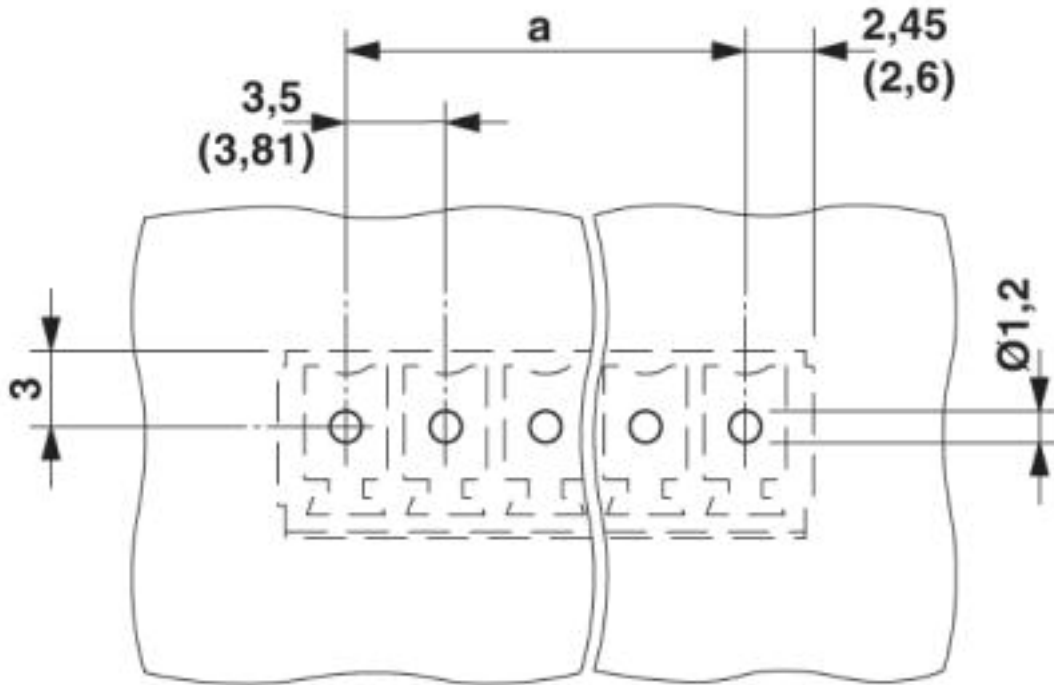

Diagram

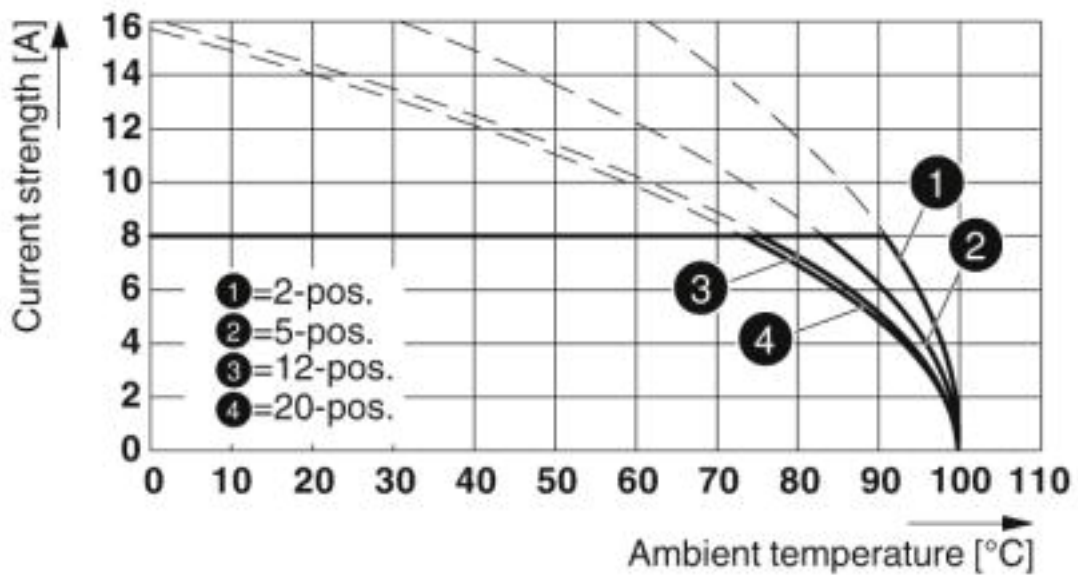

Type: MC 1,5/...-ST-3,5 with MCV 1,5/...-G-3,5

# Printed-circuit board connector - MCV 1,5/18-G-3,5 - 1843761

Dimensional drawing

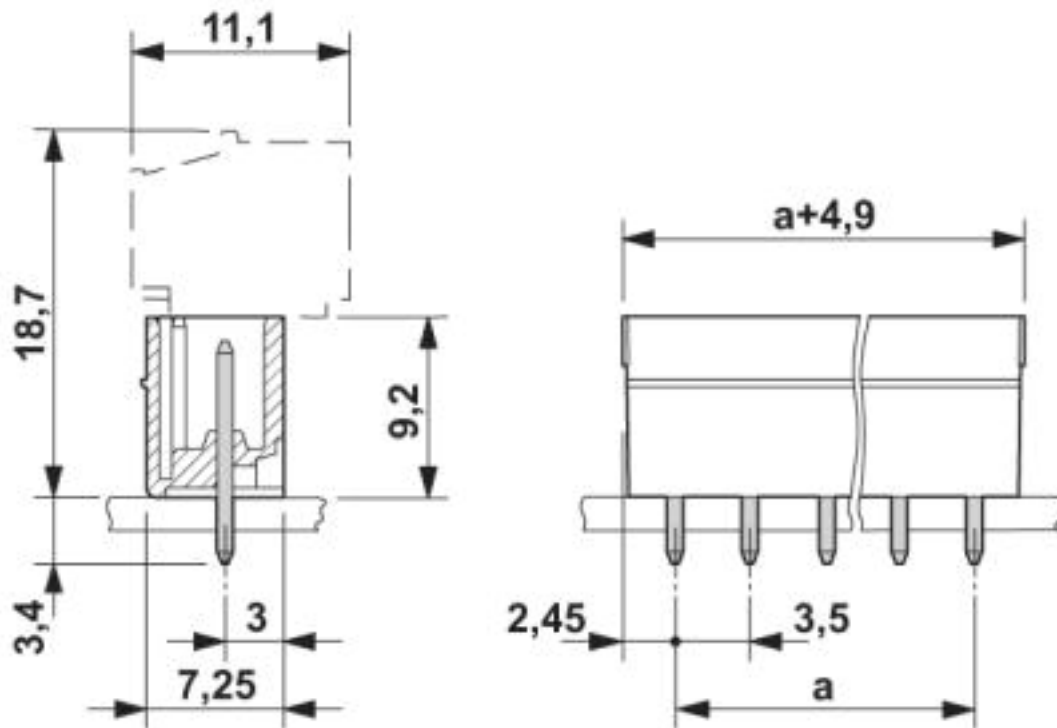

## Approvals

Approvals

Approvals

CSA / IECCEB CB Scheme / VDE Gutachten mit Fertigungsüberwachung / EAC / cULus Recognized

Ex Approvals

## Approval details

CSA		<a href="http://www.csagroup.org/services-industries/product-listing/">http://www.csagroup.org/services-industries/product-listing/</a>	13631
		B	D
Nominal voltage UN		300 V	300 V
Nominal current IN		8 A	8 A

# Printed-circuit board connector - MCV 1,5/18-G-3,5 - 1843761

## Approvals

IECEE CB Scheme		<a href="http://www.iecee.org/">http://www.iecee.org/</a>	DE1-60987-B1B2
Nominal voltage UN	160 V		
Nominal current IN	8 A		

VDE Gutachten mit Fertigungsüberwachung		<a href="http://www2.vde.com/de/Institut/Online-Service/VDE-gepruefteProdukte/Seiten/Online-Suche.aspx">http://www2.vde.com/de/Institut/Online-Service/VDE-gepruefteProdukte/Seiten/Online-Suche.aspx</a>	40011723
Nominal voltage UN	160 V		
Nominal current IN	8 A		

EAC		B.01742
-----	--	---------

cULus Recognized		<a href="http://database.ul.com/cgi-bin/XYV/template/LISEXT/1FRAME/index.htm">http://database.ul.com/cgi-bin/XYV/template/LISEXT/1FRAME/index.htm</a>	E60425-20110128
	B	D	
Nominal voltage UN	300 V	300 V	
Nominal current IN	8 A	8 A	

Phoenix Contact 2019 © - all rights reserved  
<http://www.phoenixcontact.com>

PHOENIX CONTACT GmbH & Co. KG  
 Flachsmarktstr. 8  
 32825 Blomberg  
 Germany  
 Tel. +49 5235 300  
 Fax +49 5235 3 41200  
<http://www.phoenixcontact.com>