



Temperature protection device

Chip NTC thermistor

Automotive grade, for conductive glue

NTCSP series

NTCSP10 JIS 1005 [EIA 0402]

NTCSP16 JIS 1608 [EIA 0603]

REMINDERS FOR USING THESE PRODUCTS

Before using these products, be sure to request the delivery specifications.

SAFETY REMINDERS

Please pay sufficient attention to the warnings for safe designing when using this products.

Incorrect usage may cause smoke or fire.

REMINDERS

- Please use them within the ranges of the ratings and performance provided in the catalog and delivery specifications upon confirming the environments where they are to be used and installed.
- Do not use them outside the operating temperature range.
- Do not use them with the ratings or maximum permissible power levels exceeded.
- Do not quickly apply 5mW or more of load with the constant-voltage power supply as this may lead to staying in thermal runaway mode or the red-shorting of chips.
- Please be cautious of the applied voltage in thermistors as instruments may malfunction with the lowering of resistance due to self heating.
- With instruments that consumers can touch the thermistors with their hands, please carefully warn them not to touch the thermistors.
- Store them in locations where the temperature is 10°C to +40°C and the relative humidity is 75% or below, avoid environments where there are sudden changes in temperatures, direct sunlight, corrosive gas, grit, or dust, and keep them packed in a manner where no loading stress is applied in order to avoid deterioration and damage.
(Please use within 6 months after delivery.)
If the storage period is exceeded, the surface of the terminal electrode may be oxidized or sulfided and the resistance value may shift.
- When sealing thermistors, please do so upon first considering the type, quantity, hardening conditions, and adhesiveness of the sealing material and confirming its reliability.
- Avoid powerful vibrations, impact (such as by dropping), pressure, etc. on thermistors that exceed the prescribed levels.
- Do not use them for long periods of time in environments with a relative humidity of over 85%. (this excludes cases where countermeasures have been taken.)
- Do not use them in the following environments. (this excludes cases where countermeasures have been taken.)
 - Corrosive gases (Cl₂, NH₃, SO_x, NO_x, etc.)
 - Environments with highly conductive substances (electrolytes, water, saltwater, etc.)
 - Environments with acid, alkali, or organic solvents
 - Dusty areas
- When using an alumina substrate, do a reliability test beforehand certainly, and please confirm that it's no problem (Cracks don't occur to a product.)
- Please observe the following precautions when attaching them to substrates as failure to do so may result in destruction or malfunction.
 - Do not let the substrates get warped or twisted at any time during mounting.
 - The landing size must be even on both the left and right sides.
 - Do not use items that have been dropped or detached.
 - The conductive paste is used in an appropriate amount.
- Please use a substance such as resin that does not generate hydrogen (H₂) when forming insulation film over chips.
- The products listed on this specification sheet are intended for use in general electronic equipment (AV equipment, telecommunications equipment, home appliances, amusement equipment, computer equipment, personal equipment, office equipment, measurement equipment, industrial robots) under a normal operation and use condition.

The products are not designed or warranted to meet the requirements of the applications listed below, whose performance and/or quality require a more stringent level of safety or reliability, or whose failure, malfunction or trouble could cause serious damage to society, person or property.

Please note that you cannot take responsibility for the damage caused by the use of this specification beyond the scope and conditions of the applications listed below or this specification sheet.

If you plan to use this product beyond the scope and conditions of the applications listed below or this specification sheet, please consult us at advance. We will discuss the contents of the warranty in accordance with your use.

- | | |
|---|--|
| (1) Aerospace/aviation equipment | (8) Public information-processing equipment |
| (2) Transportation equipment (electric trains, ships, etc.) | (9) Military equipment |
| (3) Medical equipment | (10) Electric heating apparatus, burning equipment |
| (4) Power-generation control equipment | (11) Disaster prevention/crime prevention equipment |
| (5) Atomic energy-related equipment | (12) Safety equipment |
| (6) Seabed equipment | (13) Other applications that are not considered general-purpose applications |
| (7) Transportation control equipment | |

When designing your equipment even for general-purpose applications, you are kindly requested to take into consideration securing protection circuit/device or providing backup circuits in your equipment.

Chip NTC thermistor

Automotive grade, for conductive glue

Product compatible with RoHS directive
Corresponding to conductive glue

Overview of the NTCSP series

CHARACTERISTICS OF NTC THERMISTORS

NTC(Negative Temperature Coefficient) thermistors are manufactured from sintered metal oxides. Each thermistor consists of a combination of two to four of the following materials: manganese, nickel, cobalt and copper. NTC thermistors are semiconductor resistors that exhibit decreasing resistance characteristics with increasing temperature. TDK thermistors have low thermal time constants which result in extremely high rates of resistance change to accurately track the temperature.

FEATURES OF NTCG SERIES

- Conductive glue can mount.
- The line-up corresponding to 150 °C.
- AEC-Q200 compliant.

Fig.1 R-T Curve : 10kohm@25°C

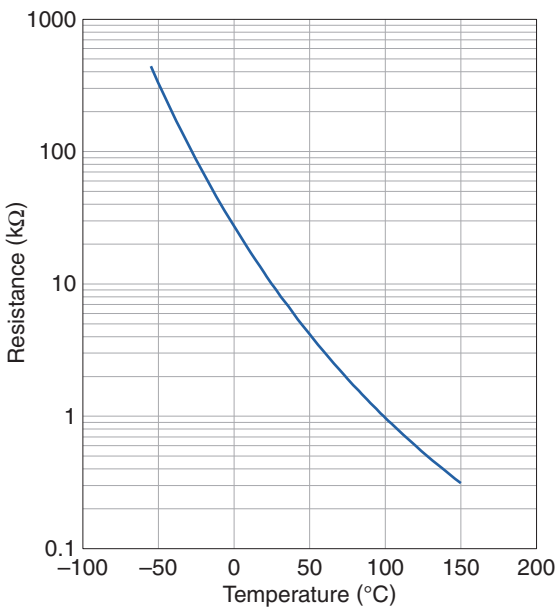
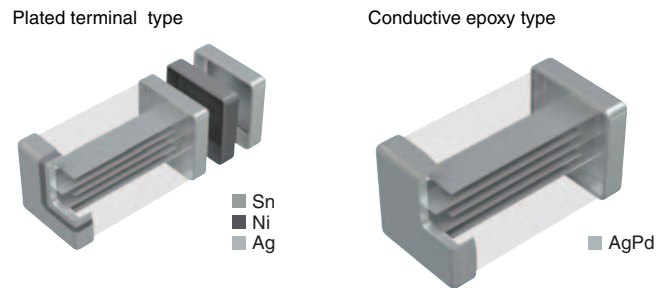

Fig.2 Internal structure of the multilayer chip Thermistors



APPLICATIONS

- For only conductive glue mounting, not for solder mounting.
- ABS, transmission, engine sensors, etc.

○ RoHS Directive Compliant Product: See the following for more details.<https://product.tdk.com/info/en/environment/rohs/index.html>

⚠ Please be sure to request delivery specifications that provide further details on the features and specifications of the products for proper and safe use. Please note that the contents may change without any prior notice due to reasons such as upgrading.

Chip NTC thermistor

Automotive grade, for conductive glue

Product compatible with RoHS directive
Corresponding to conductive glue

Overview of the NTCSP series

PART NUMBER CONSTRUCTION

NTC		SP		○○		3J		□		103		□		T		□□□	
Series name		Structural classification		shapes and dimensions Code (mm)		B constant*		B constant tolerance (%)		Nominal resistance (Ω)		Nominal resistance tolerance (%)		Packaging style		TDK internal code	
NTC thermistor		SP	Corresponding to conductive glue	10	1005			F	±1	103	10,000 (10kΩ)	F	±1	T	Taping	1S	150°C vehicle response B constant: 25/85°C
				16	1608					473	47,000 (47kΩ)			B	Bulk	1SX	150°C vehicle response B constant: 25/50°C
										104	100,000 (100kΩ)						

* B constant

B constant(K)			
2A	2000 to 2050	3A	3000 to 3050
2B	2051 to 2100	3B	3051 to 3100
2C	2101 to 2150	3C	3101 to 3150
2E	2201 to 2250	3E	3201 to 3250
2F	2251 to 2300	3F	3251 to 3300
2J	2401 to 2450	3J	3401 to 3450
2K	2451 to 2500	3K	3451 to 3500
2L	2501 to 2550	3L	3501 to 3550
2N	2601 to 2650	3N	3601 to 3650
2Q	2701 to 2750	3Q	3701 to 3750
2S	2801 to 2850	3S	3801 to 3850
		4A	4000 to 4050
		4B	4051 to 4100
		4C	4101 to 4150
		4E	4201 to 4250
		4F	4251 to 4300
		4J	4401 to 4450
		4K	4451 to 4500
		4L	4501 to 4550
		4N	4601 to 4650
		4Q	4701 to 4750
		4S	4801 to 4850

B constant calculation formula

$$B = \frac{\ln R_1 - \ln R_2}{(1/T_1) - (1/T_2)}$$

B: B constant (K)
 T1: Arbitrary temperature (K)
 T2: Arbitrary temperature different from T1 (K)
 R1: Zero-load resistance value at temperature T1 (Ω)
 R2: Zero-load resistance value at temperature T2 (Ω)
 Each temperature is measured in absolute temperature. 0°C=273.15K

Shape symbol (JIS)	Dimensions in mm			
	L	W	T	B
1005	1.00±0.05	0.50±0.05	0.50±0.05	0.1min
1608	1.60±0.10	0.80±0.10	0.80±0.10	0.2min

COMPATIBLE WITH CONDUCTIVE GLUE

Size	mm	1005	1608
Maximum rated power (25°C)*1	mW	125	125
Dissipation factors (25°C) *2	mW/°C mW/K	1	1

*1 Maximum rated power: Maximum power: at rated temperature (25°C), maximum power that can be applied continuously

*2 Dissipation factors: powered that it is equivalent that be increased in self-heating by load power thermistor at 1°C temperature

Chip NTC thermistor

Automotive grade, for conductive glue

Product compatible with RoHS directive
Corresponding to conductive glue

NTCSP series 1005 type

SHAPE & DIMENSIONS

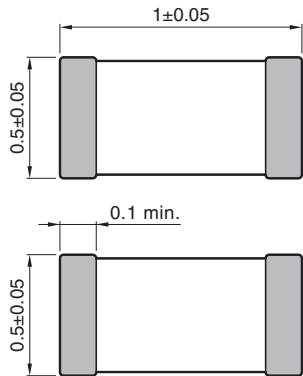

Electrode material
Internal: Pd
External: Ag/Pg

Dimensions in mm

RECOMMENDED LAND PATTERN

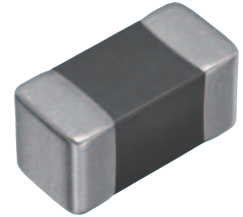
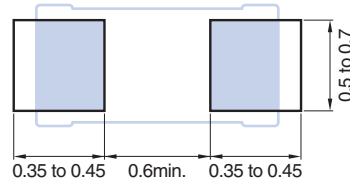

COMPATIBLE WITH CONDUCTIVE GLUE (OPERATING TEMPERATURE RANGE : -55 to 150°C)

Part No.	Resistance [25°C] (Ω)	Resistance tolerance	B constant [25/50°C] (K)	B constant [25/75°C] (K)	B constant [25/85°C] (K)	B constant [25/100°C] (K)	B constant tolerance	Permissible operating current [25°C] (mA)
NTCSP103JF103FT1S	10,000	±1%	3380	3422	3435	3453	±1%	0.31
NTCSP104BF473FT1SX	47,000	±1%	4050	4098	4114	4137	±1%	0.14
NTCSP104KF104FT1S	100,000	±1%	4419	4468	4485	4509	±1%	0.10

Chip NTC thermistor

Automotive grade, for conductive glue

Product compatible with RoHS directive
Corresponding to conductive glue

NTCSP series 1608 type

SHAPE & DIMENSIONS

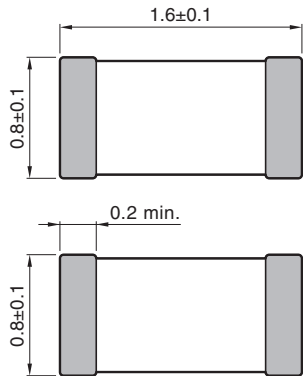

Electrode material
Internal: Pd
External: Ag/Pd

Dimensions in mm

RECOMMENDED LAND PATTERN

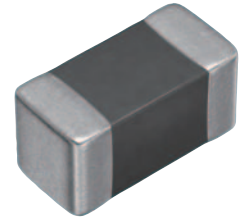
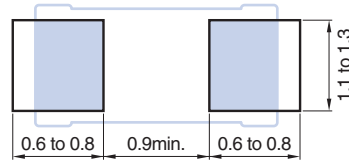

COMPATIBLE WITH CONDUCTIVE GLUE (OPERATING TEMPERATURE RANGE : -55 to 150°C)

Part No.	Resistance [25°C] (Ω)	Resistance tolerance	B constant [25/50°C] (K)	B constant [25/75°C] (K)	B constant [25/85°C] (K)	B constant [25/100°C] (K)	B constant tolerance	Permissible operating current [25°C] (mA)
NTCSP163JF103FT1S	10,000	±1%	3380	3422	3435	3453	±1%	0.31
NTCSP164BF473FT1SX	47,000	±1%	4050	4098	4114	4137	±1%	0.14
NTCSP164KF104FT1S	100,000	±1%	4419	4468	4485	4509	±1%	0.10

Chip NTC thermistor

Automotive grade, for conductive glue

Product compatible with RoHS directive
Corresponding to conductive glue

NTCSP series RT table

R-T TABLE ACQUISITION PROCEDURE

1. Access the top page of the TDK chip NTC thermistor (protective device)
<https://product.tdk.com/info/en/products/protection/temperature/chip-ntc-thermistor/index.html>

2. Click [Search by Part No.]
https://product.tdk.com/en/search/protection/temperature/chip-ntc-thermistor/part_no/



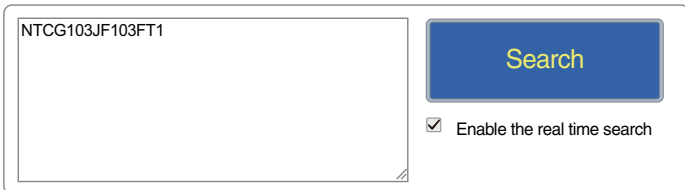



3. Enter the product name you want in the RT table in the box and click the Search button.
(Example: NTCG103JF103FT1)







Wildcard and Multiple Part number.

- Question mark (?) and asterisk (*) can be used as wildcard characters. The question mark (?) matches any single character, and the asterisk (*) matches any sequence of characters.
- Enter only one part number per line. Up to 50 part numbers can be searched simultaneously.
- A part number search is normally performed using a prefix search. If you wish to use a suffix search, enter an exclamation mark (!) at the end of the Part No.

4. Click the displayed product name.
(Example: NTCG103JF103FT1)

Check	Catalog / Data Sheet ?	Images	Part No. ?	Distributor Inventory	Brand	Apps.	Feature
<input type="checkbox"/>							
<input type="checkbox"/>			 NTCG103JF103FT1	Buy Now	TDK		125°C UL
<input type="checkbox"/>			New NTCG103JF103FT1S	Buy Now	TDK		150°C AEC-Q200

5. Individual pages are displayed and click the RT table in the "Document" on the right side bar.

Documents
 Catalog
 RoHS Certificate
 SVHC/REACH Certificate
 Selection Guide
 RT Sheet

6. You can download the csv file in the 1°C step of the RT table for the product.

 Please be sure to request delivery specifications that provide further details on the features and specifications of the products for proper and safe use. Please note that the contents may change without any prior notice due to reasons such as upgrading.

Chip NTC thermistor

Automotive grade, for conductive glue

Product compatible with RoHS directive
Corresponding to conductive glue

Attention in the board design

BOARD DESIGN

When attached to NTC substrate thermistor, amount of conductive glue has direct impact on NTC thermistor after mounting. Thus, sufficient consideration is necessary.

Set of land dimensions

As the stress rises in the NTC thermistor owing to the increase in silver, breakage and cracks will occur. Cause including crack, as caution on board land design, configure the shape and dimensions so that the amount of conductive glue is appropriate.

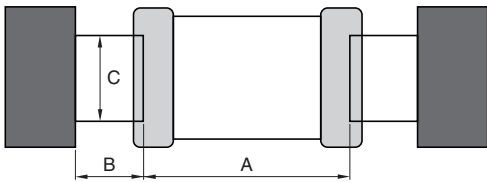

Shape symbol	Symbol		
	A	B	C
1005	0.6min.	0.35 to 0.45	0.50 to 0.70
1608	0.9min.	0.60 to 0.80	1.10 to 1.30

Amount of conductive glue

Excessive amount of conductive glue during mounting can cause electrical path formation under the chip (between the lands).

In addition, when the amount of conductive glue is excessive, the terminal electrode sticking force is insufficient, causing chip falling off, which may affect the reliability of the circuit. A typical example of the amount of conductive glue is shown below.

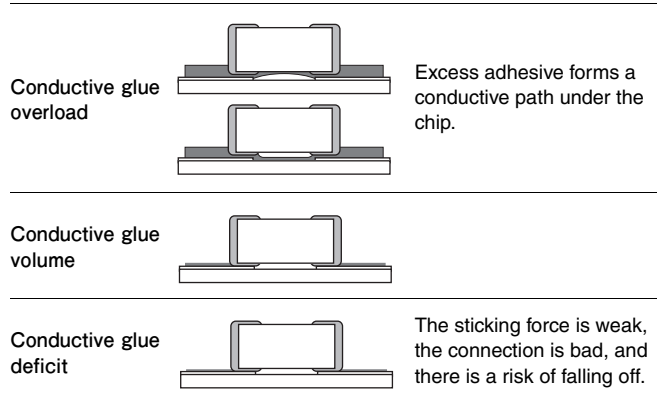

Attention on the mounting

APPLICATION TO BOARD

Mounting head pressure

Under suction nozzle if dead point too, during implementation, excessive force joins of NTC thermistor low, as cause causes of crack, please use with reference to something about following.

- 1) The bottom dead center of the suction nozzle is set on the upper surface of the substrate to adjust the excessive load to the substrate.
- 2) Nozzle pressure at implementation is 1N – 3N in static load, please.

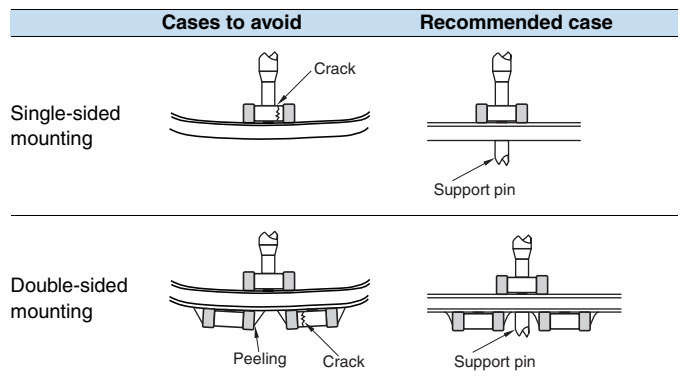

⚠ Please be sure to request delivery specifications that provide further details on the features and specifications of the products for proper and safe use. Please note that the contents may change without any prior notice due to reasons such as upgrading.

Chip NTC thermistor

Automotive grade, for conductive glue

Product compatible with RoHS directive
Corresponding to conductive glue

Single-part component handling

(1) To drop impact, as there is possibility that breakage and crack is entered, do not NTC thermistor that(1) NTC thermistor falls.

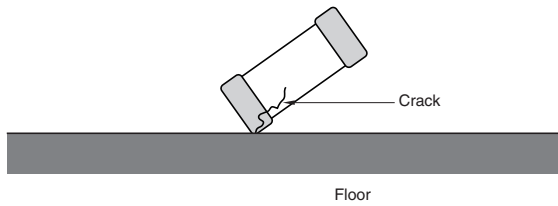

(2) At stacking storage after implementation and treatment of substrate, corner of boards is regarded as NTC thermistor. Please be careful, as there is the possibility that breakage and cracks will occur on impact.

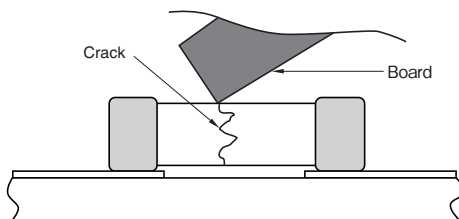

Chip NTC thermistor

Automotive grade, for conductive glue

Product compatible with RoHS directive
Corresponding to conductive glue

Packaging style

REEL DIMENSIONS

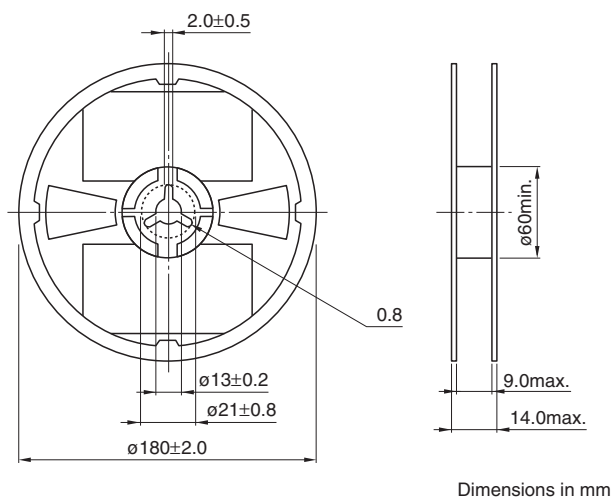

PACKAGE QUANTITY, PRODUCT WEIGHT

Type	Package quantity (pieces/reel)	Individual weight (mg)
NTCSP10	10,000	1.3
NTCSP16	4,000	5.0

TAPE DIMENSIONS

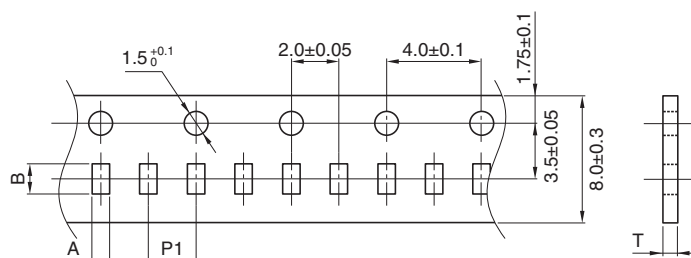

Type	A	B	P1	T
1005	0.65+0.05/-0.1	1.15+0.05/-0.1	2±0.05	0.65max.
1608	1.1±0.2	1.9±0.2	4.0±0.1	1.1max.

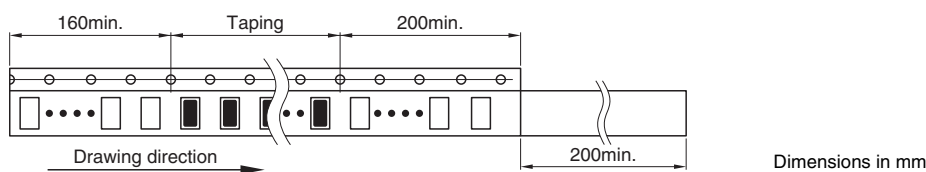

Please be sure to request delivery specifications that provide further details on the features and specifications of the products for proper and safe use.
Please note that the contents may change without any prior notice due to reasons such as upgrading.

Chip NTC thermistor

Automotive grade, for conductive glue

Product compatible with RoHS directive
Corresponding to conductive glue

Description and definition of terms

INITIAL RESISTANCE

Thermistor resistance is a function of absolute temperature as indicated by the following relationship:

$$R=R_0 \cdot \exp B \left(\frac{1}{T} - \frac{1}{T_0} \right) \dots\dots\dots (1)$$

Here R₀, R(kΩ) are the respective resistance values when the surrounding temperature is T₀, T(K). B is the thermistor constant(B constant below).

B CONSTANT

The B constant is found from the following equation:

$$B= \frac{2.3026(\log R - \log R_0)}{\frac{1}{T} - \frac{1}{T_0}} \dots\dots\dots (2)$$

This B characteristic is indicated by the slope of the linear plot of log R-1/T inverse absolute temperature. The B constant value is generally in the vicinity of 2500K to 5000K. B constant values of 3000K to 4000K are frequently used for measurements.

Resistance-temperature characteristics (Fig.1)

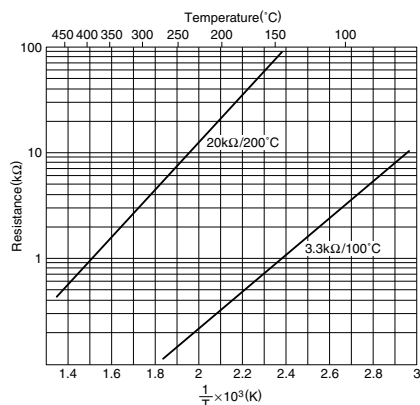

TEMPERATURE COEFFICIENT

The relationship between temperature coefficient α and B becomes:

$$\alpha = \frac{1}{R} \cdot \frac{dR}{dT} = - \frac{B}{T^2} \times 100(\%/^{\circ}C) \dots\dots\dots (3)$$

The negative sign of the temperature coefficient indicates that the temperature coefficient decreases as both thermistor resistance and temperature rise. If B is taken as 3400K, the temperature coefficient found at 20°C (293.15K) becomes -4%/°C.

HEAT DISSIPATION COEFFICIENT

Temperature rises due to thermal energy formed as electrical current flows through the thermistor. The thermistor temperature T₀ is then related to the surrounding temperature T_a and the electrical input W:

$$W=k(T_0-T_a)=V \cdot I(mW) \dots\dots\dots (4)$$

$$k= \frac{W}{T_0-T_a} (mW/^{\circ}C) \dots\dots\dots (5)$$

This k value is the heat dissipation coefficient, which represents the additional electrical power (mW/°C) needed to raise the thermistor temperature by 1°C. This heat dissipation coefficient varies with changes in the measurement and environmental conditions. When a thermistor is used for temperature measurement, it is naturally important to lower the applied electrical current as much as possible in order to reduce measurement error resulting from self heating.

⚠ Please be sure to request delivery specifications that provide further details on the features and specifications of the products for proper and safe use. Please note that the contents may change without any prior notice due to reasons such as upgrading.

Chip NTC thermistor

Automotive grade, for conductive glue

Product compatible with RoHS directive
Corresponding to conductive glue

Description and definition of terms

VOLTAGE - CURRENT CHARACTERISTIC

The voltage - current characteristic indicates the drop in voltage as electrical current through the thermistor is gradually increased.

Voltage-current characteristics (Fig.2)

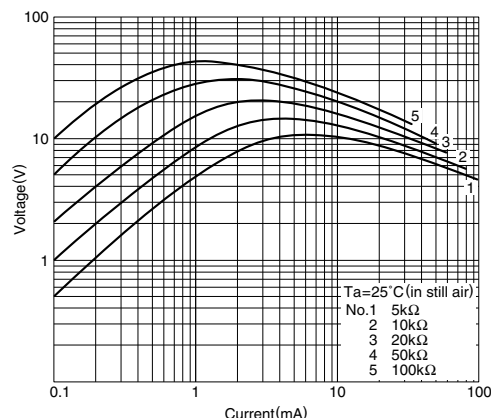

HEATING TIME CONSTANT

The time period required to heat up a thermistor from a certain temperature T_0 over a target temperature rise is called the heating time constant. Various types of heating time constants are indicated by the symbols shown in Table 1 as determined by the percent change from T_0 toward the target temperature. The standard change is typically taken to be 63.2%.

Thermal time constants (Fig.3)

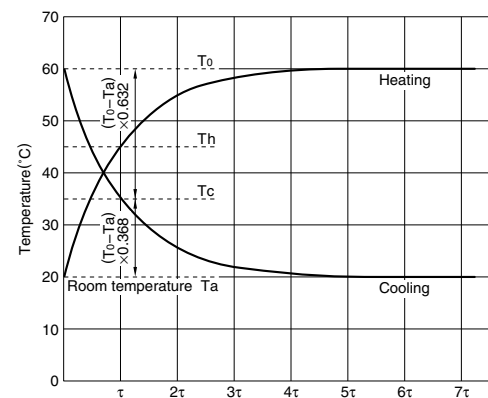

Table 1 Heating time constant and temperature change ratio

Code	Rate of change (%) for $T_0 - T_a$
τ	63.2
2τ	86.5
3τ	95.0
4τ	98.2
5τ	99.4
6τ	99.8
7τ	99.9

PERMISSIBLE OPERATING CURRENT

This is the maximum load current limit below 1°C temperature rise due to thermistor self-heating. It's possible to express it in the following system.

$$\text{Maximum allowed current [mA]} = \sqrt{(\text{Heat dissipation constant [mW/°C]} \div \text{Resistance}[\Omega])}$$

⚠ Please be sure to request delivery specifications that provide further details on the features and specifications of the products for proper and safe use. Please note that the contents may change without any prior notice due to reasons such as upgrading.