

ALVIUM MIPI CSI-2 CAMERAS

Adapter Boards for Nitrogen6_MAX and Wandboard i.MX6

User Guide

V1.0.3

MIPI CSI-2 adapter boards at a glance



Read this document carefully

Learn to use adapter boards in the most safe and efficient way and avoid damage to your embedded system.

Shipping contents



Components not included

FPC cables and microSD cards are not included in the shipping contents.

Adapter Board for Boundary Devices Nitrogen6_MAX

No.	Component	Details
1	Adapter board	For Boundary Devices Nitrogen6_MAX
2	I/O terminal	Phoenix MC 1,5/6-G-3,5 Removable
3	Cable tie	75 mm × 2.5 mm
4	Nut	M2
5	Bolt	M2 × 10 mm
6	Washers	2 pieces M2 Inside diameter: 2.2 mm Outside diameter: 4.5 mm Thickness: 0.3 mm to 0.5 mm
7	Jumper	Standard, plastic isolation

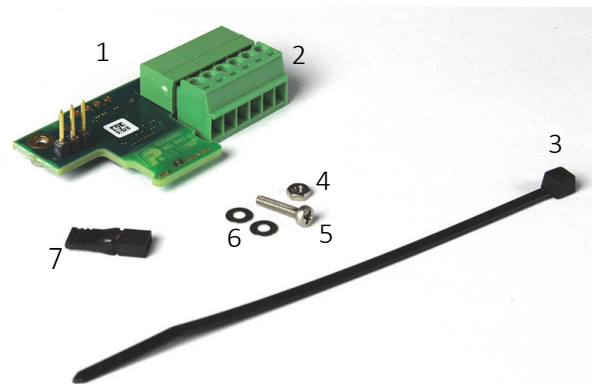

Table 1: Shipping contents for adapter for Nitrogen6_MAX

Adapter Board for Wandboard i.MX6 Series

No.	Component	Details
1	Adapter board	For Wandboard i.MX6 series
2	Spacer sleeves	2 pieces Only for Wandboard i.MX6 Solo and Dual M3 Inside diameter: 3.5 mm Outside diameter: 6 mm Thickness: 4 mm
3	I/O terminal	Phoenix MC 1,5/4-G-3.5 Removable
4	Spacer bolts	2 pieces 10 mm × 5 mm Inside thread: M3 × 6.5 mm Outside thread: M3 × 8 mm
5	Jumper	Standard, plastic isolation

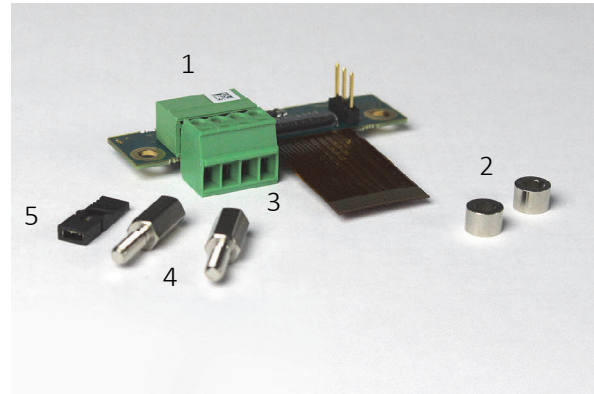

Table 2: Shipping contents for adapter for Wandboard i.MX6

What else do you need?



Technical information and ordering

For all information about Alvium CSI-2 cameras and accessories, see

- for MIPI CSI-2 cameras: www.alliedvision.com/en/support/technical-documentation/alvium-csi-2-documentation.
- Please contact your Allied Vision Sales representative for ordering and for additional information on hardware options for Alvium cameras.

Contact us

Website

General

www.alliedvision.com/en/contact

Distribution partners

www.alliedvision.com/en/about-us/where-we-are

Email

General

info@alliedvision.com

Support

support@alliedvision.com

Sales Offices

Europe, Middle East, and Africa

T// +49 36428 677-230

North and South America

Toll-free: +1 877 USA 1394

T// +1 978 225 2030

California: +1 408 721 1965

Asia-Pacific

T// +65 6634 9027

China

T// +86 21 64861133

Headquarters

Allied Vision Technologies GmbH

Taschenweg 2a

07646 Stadtroda, Germany

T// +49 36428 677-0

F// +49 36428 677-28

Contents

MIPI CSI-2 adapter boards at a glance	2
Shipping contents	2
Adapter Board for Boundary Devices Nitrogen6_MAX	2
Adapter Board for Wandboard i.MX6 Series	3
What else do you need?	3
Contact us	4
Document history and conventions	7
Document history	8
Conventions used in this user guide	8
Typographical styles	8
Symbols and notes	8
Component naming	9
Compliance, safety, and intended use	10
Compliance notifications	11
Intended use	11
Product safety	11
Embedded systems	11
Electrical connections	11
Electrostatic discharge (ESD)	12
Camera power	12
FPC connectors	12
Copyright and trademarks	14
Specifications	15
Specifications: Adapter for Nitrogen6_MAX	16
Dimensions and PCB layout	17
Electronic schematics	18
I/O terminal	19
Specifications: Adapter for Wandboard i.MX6	20
Dimensions and PCB layout	21
Electronic schematics	22
I/O terminal	23
Using adapter boards	24
Embedded system accessories	25
Connecting FPC cables to Hirose FPC connectors	25
Installing the adapter for Nitrogen6_MAX	27
Connecting the camera FPC cable	27
Fastening the FPC cable with a cable tie	28

Connecting the embedded board	29
Tightening the mounting bolt	31
Removing and inserting microSD cards	31
Setting power modes	32
Connecting the camera	32
Installing adapter boards for Wandboard i.MX6 Solo and Dual	33
Connecting the embedded board	33
Mounting the adapter board	34
Removing and inserting microSD cards	35
Installing adapter boards for Wandboard i.MX6 Quad and QuadPlus	36
Removing the embedded board's heat sink	36
Connecting the embedded board	37
Mounting the adapter board	38
Removing and inserting microSD cards	39
Setting power modes for Wandboard i.MX6 series	40
Connecting Wandboard i.MX6 series boards to the camera	41

Document history and conventions



This chapter includes:

Document history	8
Conventions used in this user guide.....	8
Component naming	9

Document history

Version	Date	Remarks
V1.0.3	2020-May-06	Applied editorial changes.
V1.0.2	2019-Nov-27	Removed note for additional information.
V1.0.1	2019-Nov-21	<ul style="list-style-type: none"> Renamed the document to separate from other adapter boards' user guides. Applied editorial changes.
V1.0.0	2019-May-29	Release version

Table 3: Document history

Conventions used in this user guide

To give this user guide an easily understood layout and to emphasize important information, the following typographical styles and symbols are used:

Typographical styles

Style	Function
Emphasis	Highlighting important things
Web links and references	Links to webpages and internal cross references

Table 4: Typographical styles

Symbols and notes



NOTICE

Material damage

Precautions are described.



Practical tip

Additional information helps to understand or ease handling the camera and components



Additional information

Web link or reference to an external source with more information is shown.

Component naming

Components described in this user guide are not defined by common standards. Therefore, naming must be accurate to avoid misconceptions. Because naming is lengthy, reading is difficult. Simplified terms are used in this document.

Long version	Short version	Alvium CSI-2 Cameras Safety and Usage Instructions
Adapter Board for Boundary Devices Nitrogen6_MAX Series	adapter for Nitrogen6_MAX	Not applicable
Adapter Board for Wandboard i.MX6 Series	adapter for Wandboard i.MX6	Not applicable
MIPI CSI-2 ¹ adapter board	adapter board	embedded board adapter
MIPI CSI-2 FPC cable	FPC cable	FPC cable

¹MIPI CSI-2 Mobile Industry Processor Interface Camera Serial Interface 2

Table 5: MIPI CSI-2 adapter board naming

Compliance, safety, and intended use



This chapter includes:

Compliance notifications	11
Intended use	11
Product safety	11
Copyright and trademarks	14

Compliance notifications



Intended use

Allied Vision's objective is the development, design, production, maintenance, servicing and distribution of digital cameras and components for image processing. We are offering standard products as well as customized solutions.

Intended use of Allied Vision product is the integration into Vision systems by professionals. All Allied Vision product is sold in a B2B setting.

Allied Vision isn't a legal manufacturer of medical product. Instead, Allied Vision cameras and accessories may be used as components for medical product after design-in by the medical device manufacturer and based on a quality assurance agreement (QAA) between Allied Vision (supplier) and medical device manufacturer (customer). Allied Vision's duties in that respect are defined by ISO 13485, clause 7.2 (customer-related processes, equivalent to ISO 9001, clause 8.2).

Product safety

To prevent material damage, read the following to understand risks in using adapter boards.

Embedded systems

Setup and operation of Alvium CSI-2 cameras in embedded systems is different than for cameras in PC-based systems. Components can easily be damaged. If you are unfamiliar with embedded systems, be extremely careful. Follow the instructions in the Alvium CSI-2 Cameras User Guide.

Electrical connections

The MIPI CSI-2 standard does not specify electrical connections as extensively as USB or GigE standard. Read specifications carefully.

Alvium CSI-2 cameras are not protected against damage caused by reverse polarity.

Electrostatic discharge (ESD)

Electrostatic discharge (ESD) is dangerous for electronic devices, especially when tools or hands get in contact with connectors. We recommend measures to avoid damage by ESD:

- **Unpacking:** Remove the adapter board from its anti-static packaging only when your body is grounded.
- **Workplace:** Use a static-safe workplace with static-dissipative mat and air ionization.
- **Wrist strap:** Wear a static-dissipative wrist strap to ground your body.
- **Clothing:** Wear ESD-protective clothing. Keep components away from your body and clothing. Even if you are wearing a wrist strap, your body is grounded but your clothes are not.
- **Housing:** use an ESD protective housing, including the camera, embedded board, adapter board, and FPC cable.

Camera power

Operating cameras beyond the specified range damages cameras. Cameras are powered using the FPC connector at a maximum input of 5.5 VDC, using a limited power source (LPS), according to IEC62368-1: 2014 (Second Edition) with maximum 1.5 A per camera. Cameras are not intended to be connected to DC distribution networks.

FPC connectors

Hirose FH55-22S-0.5SH FPC connectors enable compact camera design. The small-sized connectors are sensitive to mechanical stress and are specified for maximum 20 mating and unmating cycles. Especially if you are inexperienced with this connector, be very cautious. If the FPC connector is broken, the complete device must be replaced. Follow the instructions in [Using adapter boards](#) on page 24 carefully.

- Avoid stress to FPC connectors.
- Allow only the FPC cable to touch conductors.

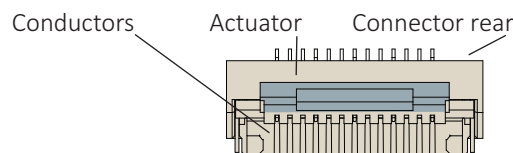

Figure 1: Hirose FH55-22S-0.5SH FPC connector



Additional information

For technical data and more instructions on the Hirose FH55-22S-0.5SH connector, see the manufacturer data sheet at www.hirose.com.

Handling the actuator

- Move the actuator only between 0° (locked position) to 105° (open position).
- Carefully flip the actuator at the middle with your finger nail, see [Connecting FPC cables to Hirose FPC connectors](#) on page 25.

MIPI CSI-2 FPC cables

FPC cable position

Short circuits of the FPC cable can damage the camera or connected hardware.

- Insert the FPC cable into the connector with cable guiding tabs matching the connector's side guides. See [Connecting FPC cables to Hirose FPC connectors](#) on page 25.
- Connect the camera and the embedded board (adapter) only as shown by the arrow printed on the FPC cable, see [Connecting FPC cables to Hirose FPC connectors](#) on page 25.

FPC cables and stress

Over-stressed FPC cables can damage the camera and connected hardware. When camera and embedded board are twisted against each other or pulled apart from each other with too much force, the FPC cable is over-stressed. Spring contacts of FPC connectors are worn out, causing short circuits and unreliable electrical connections.

- Insert the FPC cable into the FPC connector at 12° to the PCB board surface. See [Connecting FPC cables to Hirose FPC connectors](#) on page 25.
- Allow only slight bending of the FPC cable (minimum bending radius: 10 mm).
- For strain relief, fasten the FPC cable by a cable tie on both cable ends if possible.

No hot-plugging for MIPI CSI-2

Alvium CSI-2 cameras do not support hot-plugging. Hot-plugging can destroy camera and connected hardware by high inrush current.

- Disconnect power supplies before connecting FPC cables.

FPC cables signal quality

Noise and electromagnetic interference can disable camera functions.

- Avoid contact to metal surfaces, causing electromagnetic interference.
- Please use cables recommended by Allied Vision.

Copyright and trademarks

All text, pictures, and graphics are protected by copyright and other laws protecting intellectual property. All content is subject to change without notice.

All trademarks, logos, and brands cited in this document are property and/or copyright material of their respective owners. Use of these trademarks, logos, and brands does not imply endorsement.

Copyright © 2020 Allied Vision Technologies GmbH. All rights reserved.

Specifications



This chapter includes:

Specifications: Adapter for Nitrogen6_MAX	16
Specifications: Adapter for Wandboard i.MX6	20

Specifications: Adapter for Nitrogen6_MAX

Feature	Specification
Product code	12314
Dimensions (Length × width × height [mm])	51 × 29 × 11.8
Mass (excluding fixing material)	10 g
Storage temperature	-10 °C to +70 °C ambient temperature
Temperature range	+5 °C to +65 °C
Relative humidity	0% to 80% (non-condensing)
Supported embedded boards	Boundary Devices Nitrogen6_Max boards: <ul style="list-style-type: none"> • Nit6Q_MAX_QCA_BRD i.MX6 Quad • Nit6Q_MAX_QCA_BRD i.MX6 QuadPlus
Supported cameras	Alvium CSI-2 cameras
Supported FPC cables	Allied Vision 12316, 12317, 12318

Table 6: Adapter for Nitrogen6_MAX specifications

Dimensions and PCB layout

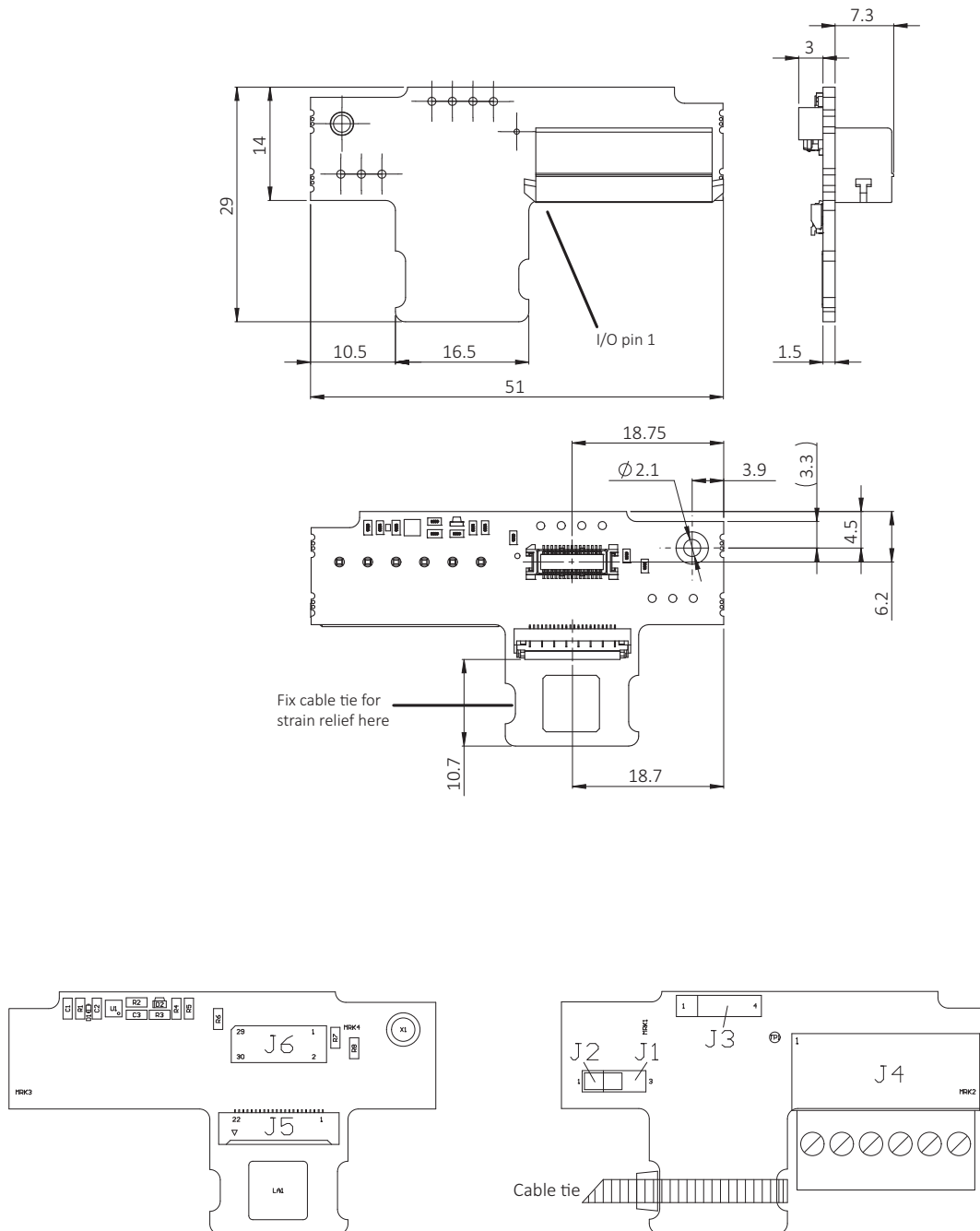

Figure 2: Adapter for Nitrogen6_MAX dimensions and PCB layout

Electronic schematics

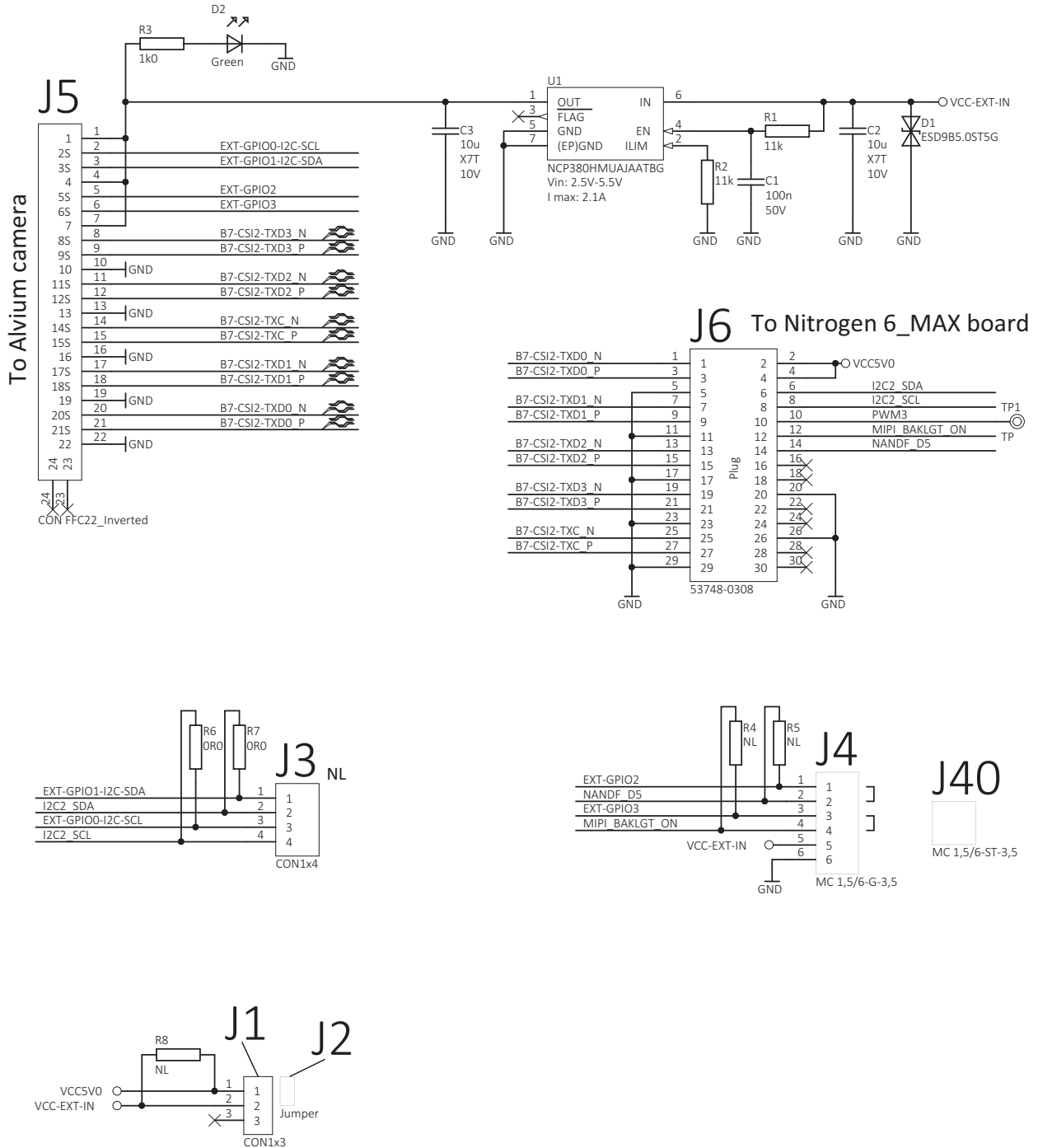

Figure 3: Adapter for Nitrogen6_MAX electronic schematics

I/O terminal



Information on the terminal screw adapter

For information on the Phoenix MC 1,5/6-G-3,5 I/O terminal adapter, see www.phoenixcontact.com.

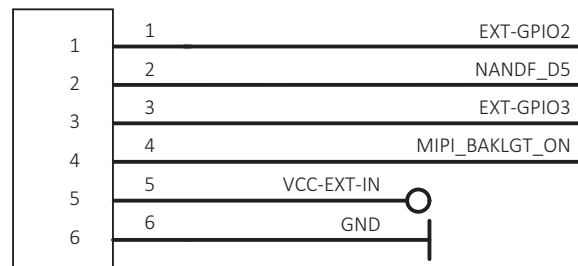
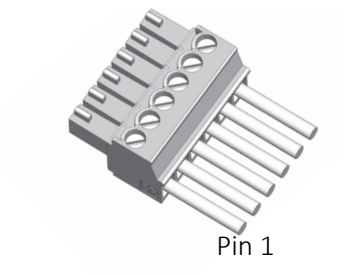

Figure 4: Adapter for Nitrogen6_MAX I/O terminal, wiring diagram

Pin	Signal	< - >	Level	Description
1	EXT-GPIO 2	IN/OUT	$U_{in} \text{ (low)} = -0.3 \text{ to } 0.8 \text{ VDC}$ $U_{in} \text{ (high)} = 2.0 \text{ to } 5.5 \text{ VDC}$ $U_{out} \text{ (low)} = 0 \text{ to } 0.4 \text{ VDC}$ $U_{out} \text{ (high)} = 2.4 \text{ to } 3.3 \text{ VDC at max. } 12 \text{ mA}$	GPIO Internal pull-up resistor: 33 k Ω to 63 k Ω
2	NANDF_D5		Please see Nitrogen6_MAX board description by the manufacturer.	
3	EXT-GPIO 3		See EXT-GPIO 2	
4	MIPI_BAKLGT_ON		Please see Nitrogen6_MAX board description by the manufacturer.	
5	VCC-EXT-IN	PWR IN	4.5 to 5.5 VDC	Power supply voltage Maximum input current: 1.5 A
6	GND	PWR	0 VDC	Power supply ground

Table 7: Adapter for Nitrogen6_MAX I/O terminal pin assignment



Connections with Nitrogen6_MAX boards

NANDF_D5 and MIPI_BAKLGT_ON lines connect directly to Nitrogen6_MAX board. For manufacturer information, please see www.boundarydevices.com.

Specifications: Adapter for Wandboard i.MX6

Feature	Specification
Product code	12362
Dimensions (Length × width × height [mm])	52 × 40.5 × 10.7
Mass (excluding fixing material)	6 g
Storage temperature	-10 °C to +70 °C ambient temperature
Operating temperature	+5 °C to +65 °C
Relative humidity	0% to 80% (non-condensing)
Supported embedded board	Wandboard i.MX6 series, revision D: <ul style="list-style-type: none"> • Wandboard Solo (i.MX6) WB-IMX6S-BW • Wandboard Dual (i.MX6) WB-IMX6U-BW • Wandboard Quad (i.MX6) WB-IMX6Q-BW • Wandboard QuadPlus (i.MX6) WB-IMX6QP-BW
Supported cameras	Alvium CSI-2 cameras
Supported FPC cables	Allied Vision 12316, 12317, 12318

Table 8: Adapter for Wandboard i.MX6 specifications

Dimensions and PCB layout

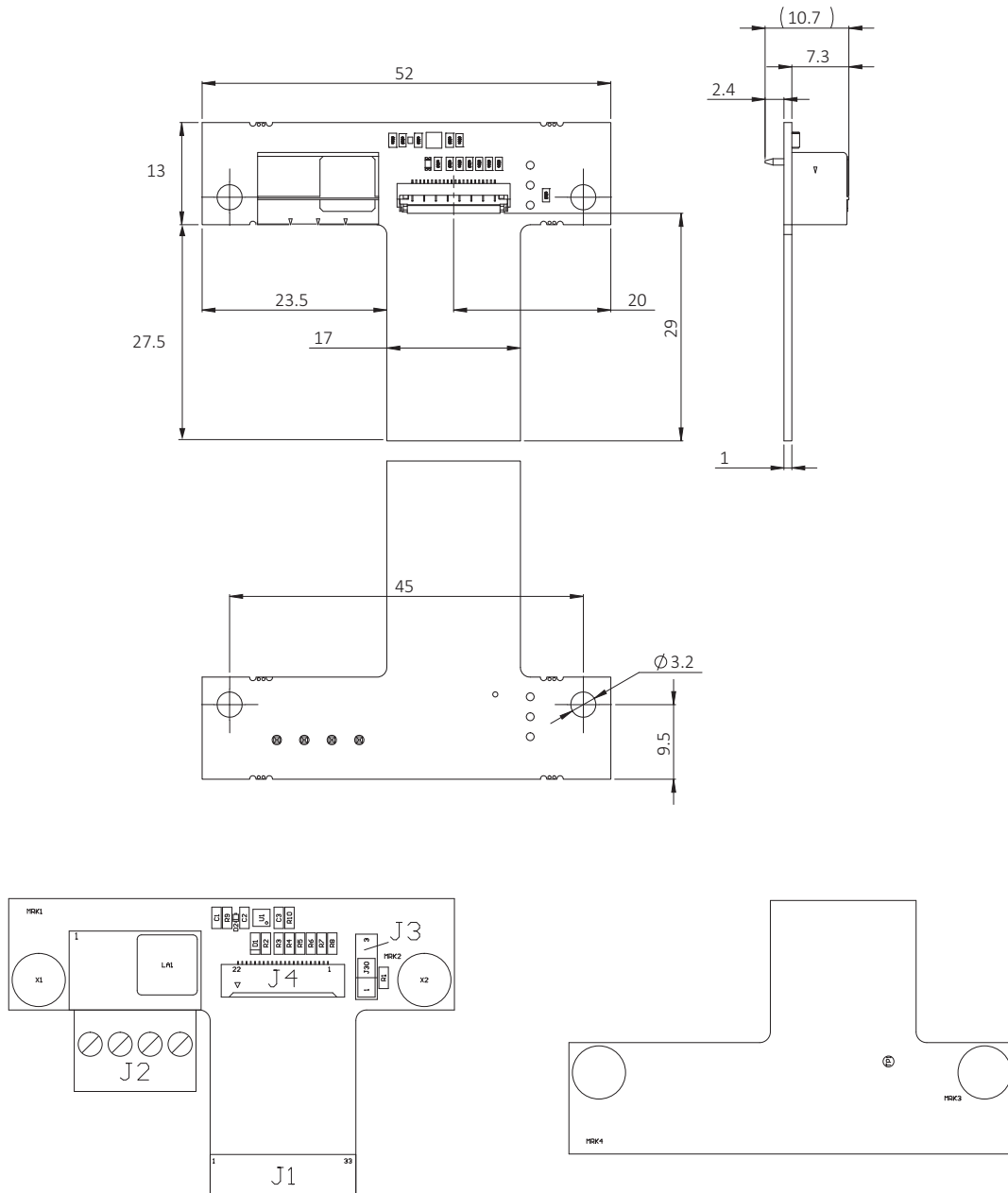

Figure 5: Adapter for Wandboard i.MX6 dimensions and PCB layout

Electronic schematics

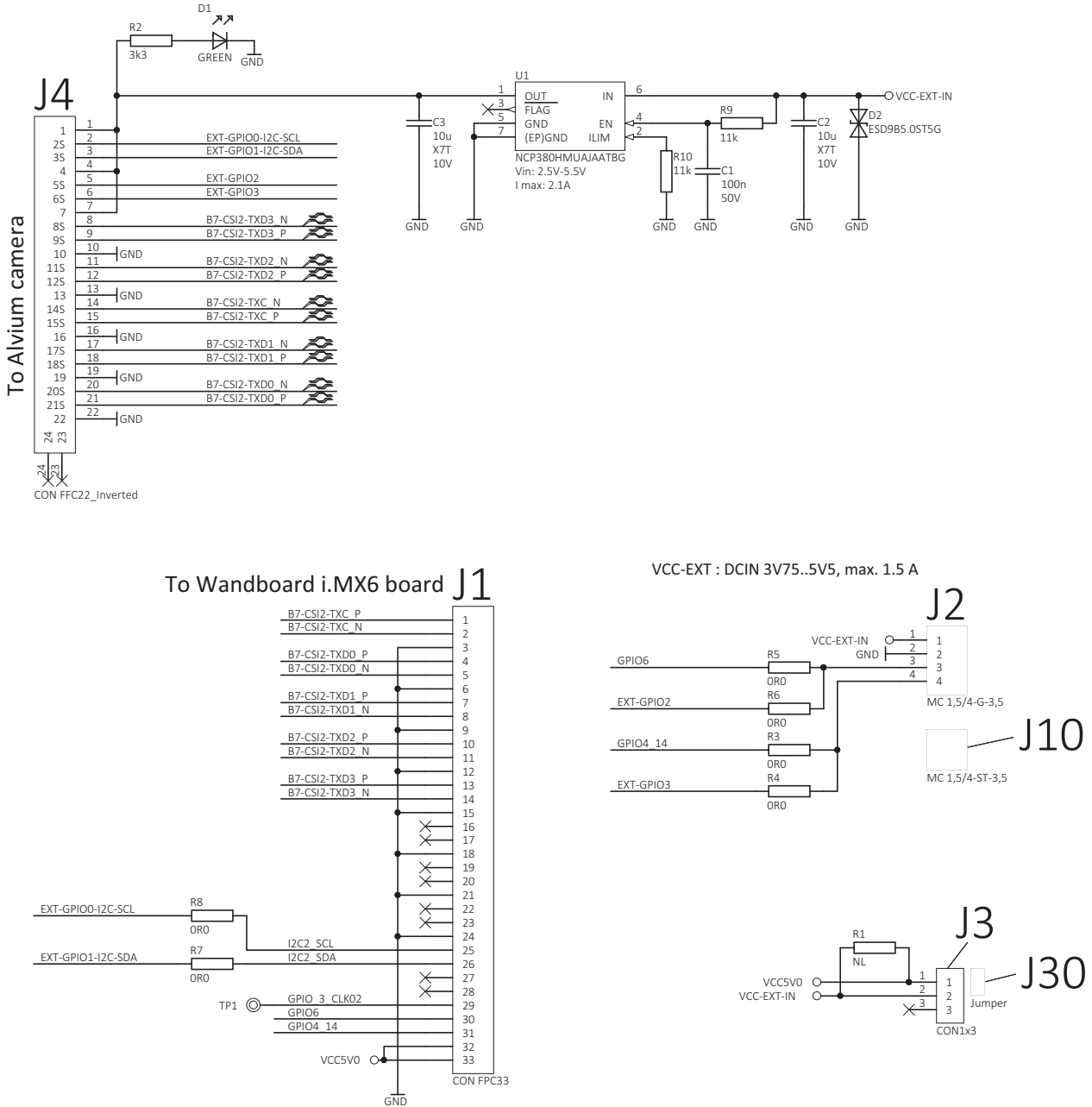

Figure 6: Adapter for Wandboard i.MX6 electronic schematics

I/O terminal



I/O terminal

For the Phoenix MC 1,5/4-G-3,5 I/O terminal, see: www.phoenixcontact.com.

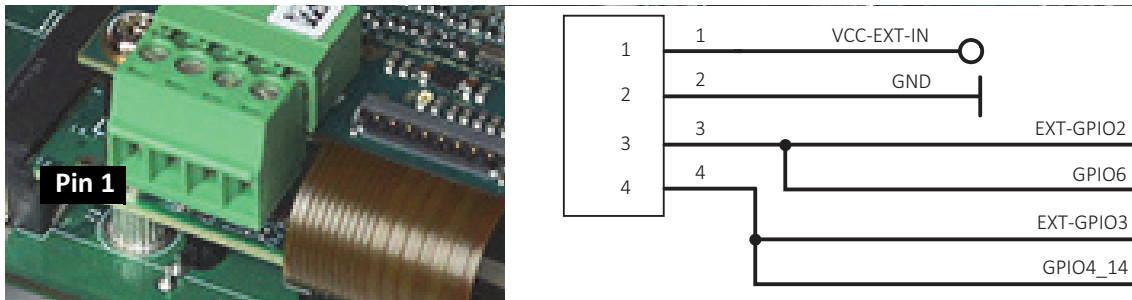

Figure 7: Adapter for Wandboard i.MX6 | I/O terminal, wiring diagram

Pin	Signal*	< - >	Level	Description
1	VCC-EXT-IN	PWR IN	4.5 to 5.5 VDC	Power supply voltage Maximum input current: 1.5 A
2	GND	PWR	0 VDC	Power supply ground
3	EXT-GPIO 2 <i>GPIO6</i>	IN/OUT	$U_{in} \text{ (low)} = -0.3 \text{ to } 0.8 \text{ VDC}$ $U_{in} \text{ (high)} = 2.0 \text{ to } 5.5 \text{ VDC}$ $U_{out} \text{ (low)} = 0 \text{ to } 0.4 \text{ VDC}$ $U_{out} \text{ (high)} = 2.4 \text{ to } 3.3 \text{ VDC at max. } 12 \text{ mA}$	GPIO Internal pull-up resistor: 33 kΩ to 63 kΩ
4	EXT-GPIO 3 <i>GPIO4_14</i>		See EXT-GPIO 2a	

*Regular style: Alviium camera; *italics: Wandboard i.MX6*

Table 9: Adapter for Wandboard i.MX6 I/O terminal pin assignment

Using adapter boards



This chapter includes:

Embedded system accessories	25
Connecting FPC cables to Hirose FPC connectors	25
Installing the adapter for Nitrogen6_MAX	27
Installing adapter boards for Wandboard i.MX6 Solo and Dual.....	33
Installing adapter boards for Wandboard i.MX6 Quad and QuadPlus.	36
Setting power modes for Wandboard i.MX6 series	40
Connecting Wandboard i.MX6 series boards to the camera	41

Embedded system accessories



FPC cables

For more information, see the Alvium Cameras Accessory Guide at www.alliedvision.com/en/support/technical-documentation/alvium-csi-2-documentation.



Designing your own embedded components

If you want to design your own components to connect Alvium CSI-2 cameras to embedded boards, contact your Allied Vision Sales representative or Allied Vision Support at support@alliedvision.com.

Proper usage of the Hirose FH55-22S-0.5SH FPC connector is vital for connecting Alvium CSI-2 cameras to embedded boards. Therefore, instructions start with usage of the FPC connector. Afterwards, setting up the adapter boards is described.

Connecting FPC cables to Hirose FPC connectors

Figure 8 shows how the FPC cable connects to the FPC connector.

Follow the instructions to connect the FPC cable to the camera and to the embedded board.

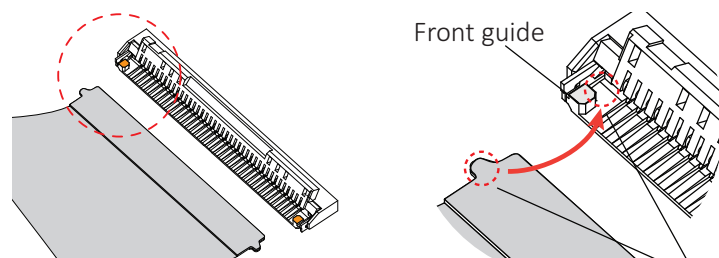

Figure 8: FPC cable and FPC connector (open position)

1. Opening the FPC connector:
With your fingernail*, flip the actuator to open position at 105° to the PCB surface, see Figure 9.

*Or use a plastic tool, as metal tools can damage the actuator.

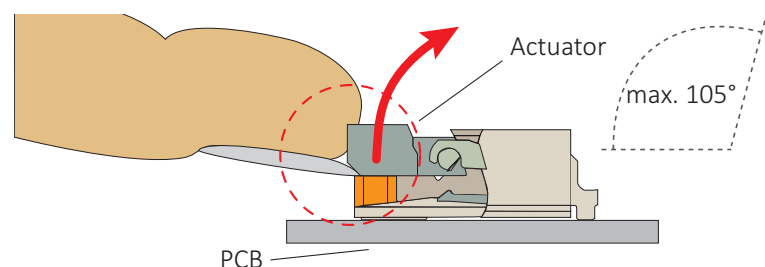

Figure 9: Opening the FPC connector

NOTICE
Damage to the camera by reverse polarity

If Alvium CSI-2 cameras are powered with reverse polarity, camera electronics is damaged.

- Before connecting camera power and I/O power, carefully read the Alvium Cameras User Guide for the FPC connector pin assignment.
- Connect the cable as shown in this section.

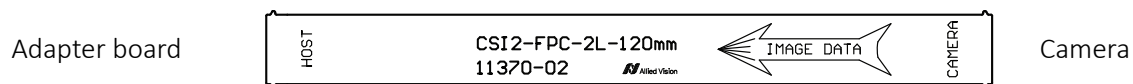

Figure 10: FPC cable image data direction

2. **Ensuring proper cable direction between host and camera**, take the FPC cable with conductors facing the FPC connector conductors (see Figure 11).

3. Inserting the FPC cable:
At a horizontal angle of 90° to the connector's rear (see Figure 11) and at a vertical angle of 12° to the PCB (see Figure 12), slowly insert the FPC cable into the actuator...

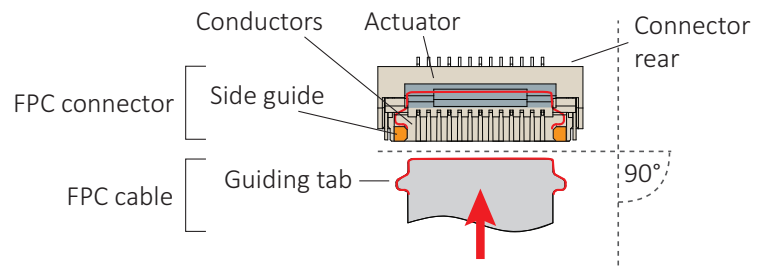

Figure 11: FPC cable and FPC connector

4. ...until cable guiding tabs are caught between connector rear and side guides (see Figure 11). Pull the cable slightly to ensure guiding tabs are properly engaged.
5. Holding the FPC cable in position, flap down the actuator to closed position (see Figure 12).

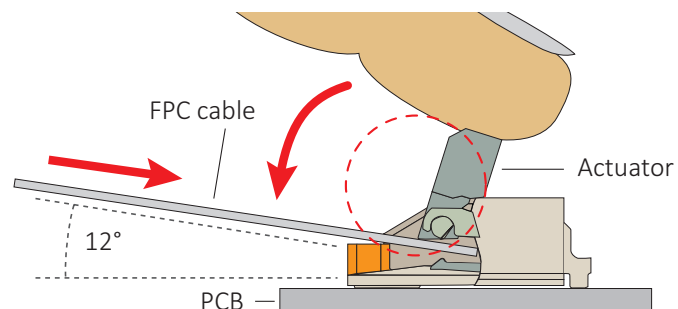

Figure 12: Engaging the FPC cable in the FPC connector

Installing the adapter for Nitrogen6_MAX



NOTICE

Damage to electronics

- Disconnect all power supplies before installing the adapter board to your embedded board.
- Reconnect power only after installation is complete.

Connecting the camera FPC cable

1. Following the instructions in [Connecting FPC cables to Hirose FPC connectors](#) on page 25, connect the FPC cable (b) to the FPC connector (c) of the adapter board (a)...

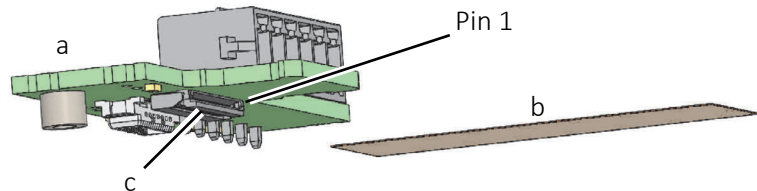

Figure 13: Adapter board and FPC cable

...observe the cable direction: The printed word “host” must point to the FPC connector of the adapter board as shown in [Figure 14](#).

2. Continue with [Fastening the FPC cable with a cable tie](#) on page 28.

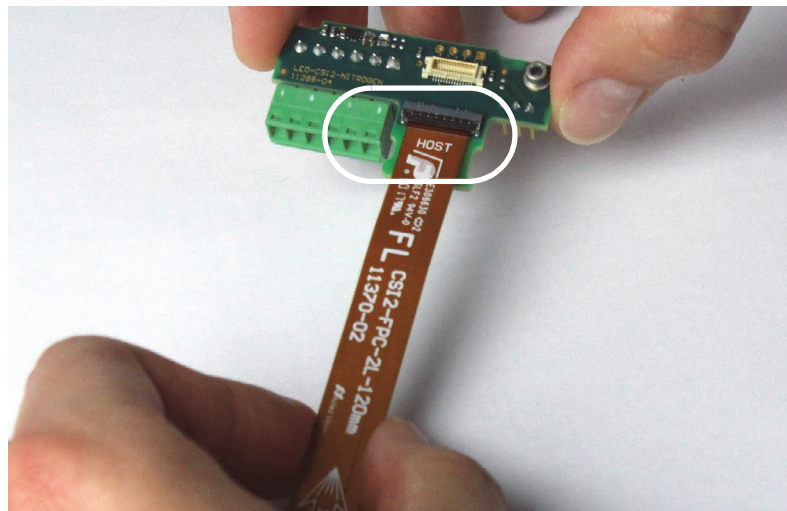

Figure 14: FPC cable being connected to the adapter board

Fastening the FPC cable with a cable tie



NOTICE

Damage to FPC connectors

A bended FPC cable can break the FPC connector's actuator.
Fasten the FPC cable with a cable tie.

1. For strain relief, fasten the FPC cable to the adapter board with a cable tie (a).

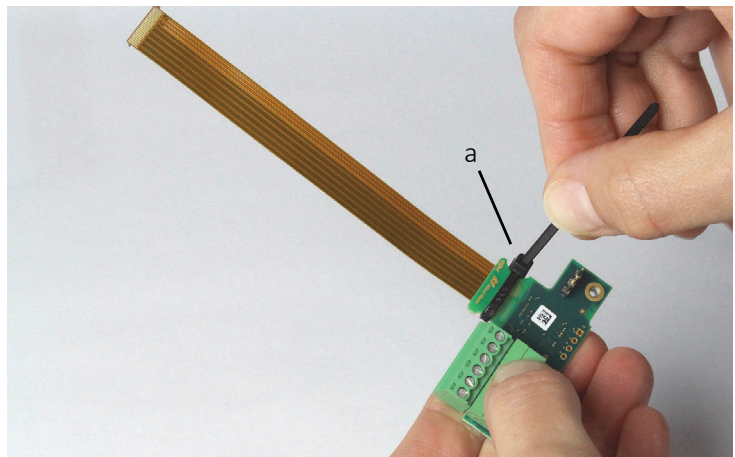

Figure 15: FPC cable being fastened by a cable tie

2. Shorten the cable strap by cutting off the protruding end.

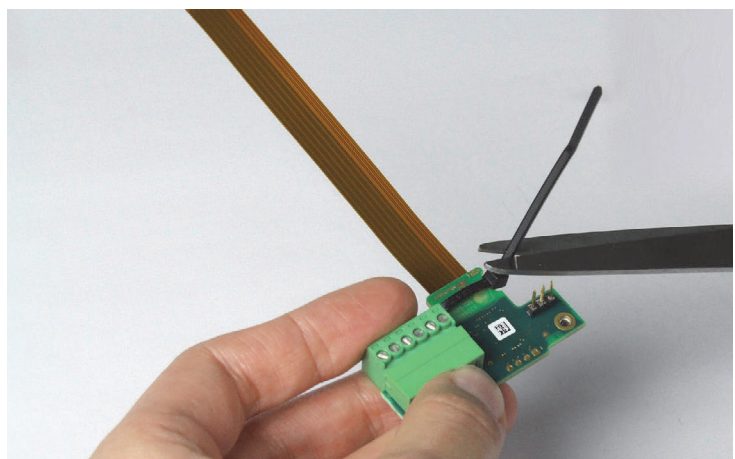

Figure 16: Cable tie being shortened

3. Continue with [Connecting the embedded board](#) on page 29.

Connecting the embedded board

Figure 17 shows how the adapter board is mounted to the Nitrogen6_MAX board:

After the MIPI CSI-2 connectors (g) of the adapter board and of the embedded board have been connected, the bolt (a) is fit through the washer (b) and the spacer sleeve (c) of the adapter board, through the mounting hole (d) of the embedded board, and another washer (e) and connected to the nut (f).

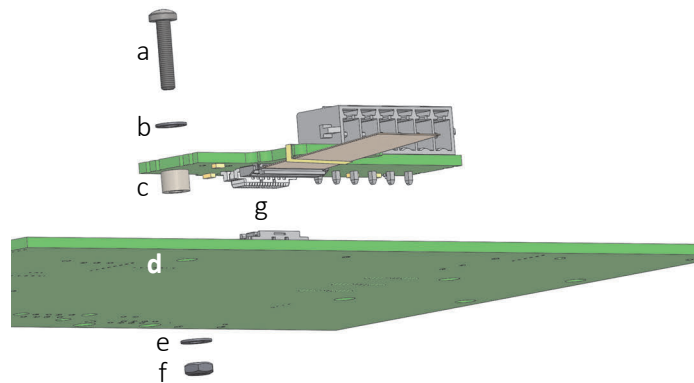

Figure 17: Mounting the adapter board overview

1. Connect the MIPI CSI-2 connector (g) of the adapter board and the MIPI CSI-2 connector (type J16) of the embedded board.

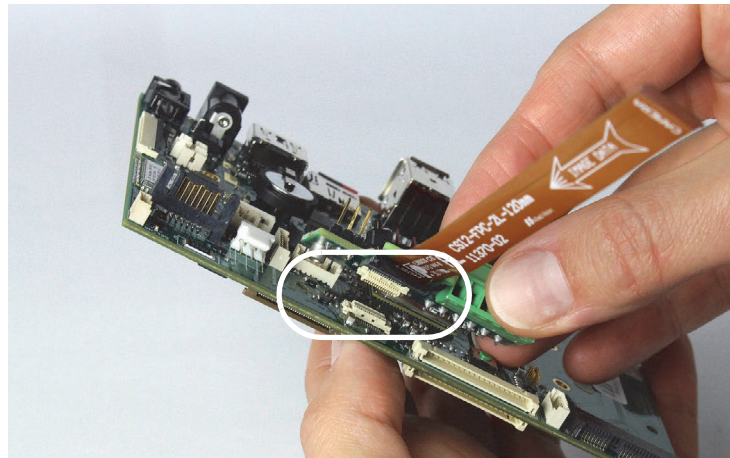

Figure 18: Connecting the MIPI CSI-2 FPC connectors

2. Fit the bolt (a) through the washer (b).
3. Push the bolt through the adapter board's spacer sleeve (c) and through the embedded board's mounting hole (d).
4. Continue with [Tightening the mounting bolt](#) on page 31.

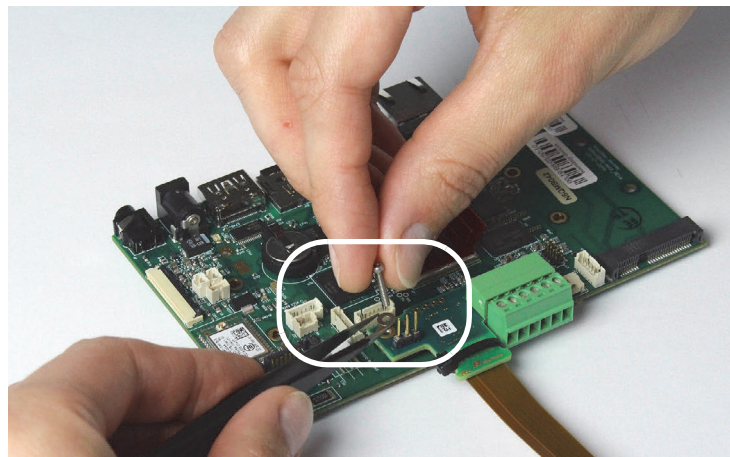

Figure 19: Fitting in the bolt

Tightening the mounting bolt

1. Fit the washer (e) onto the bolt.
2. Fit the nut (f) onto the bolt and thread at 0.3 Nm maximum torque.

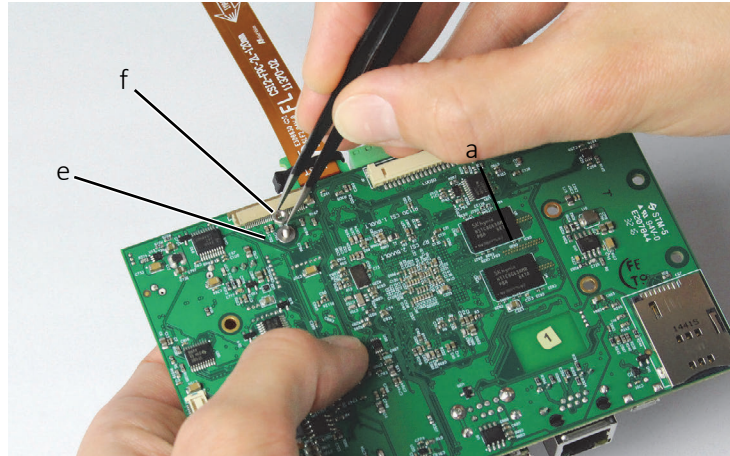

Figure 20: Fitting the washer and nut onto the bolt

3. Continue with [Removing and inserting microSD cards](#) on page 31.

Removing and inserting microSD cards

1. Push the microSD card slightly with your fingertip.
2. Continue with [Setting power modes](#) on page 32.

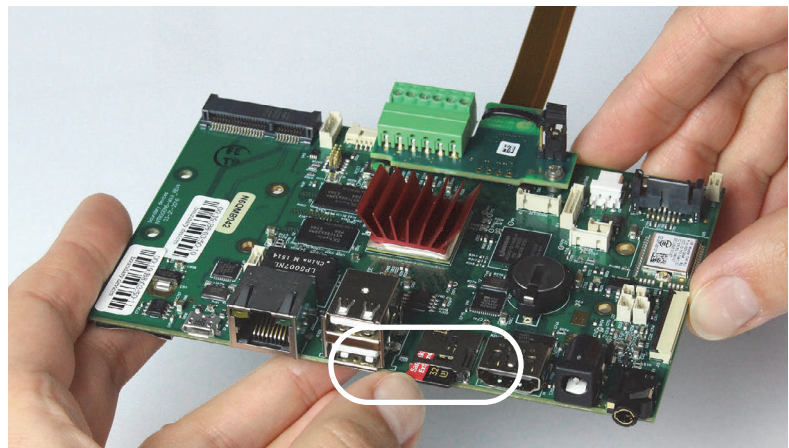

Figure 21: Inserting the microSD card

Setting power modes

1. Set jumper J1 to the corresponding position to select the power mode.

For pin assignment, see [Electronic schematics](#) on page 18.

2. To finally connect the FPC cable to the camera, follow the instructions in [Connecting FPC cables to Hirose FPC connectors](#) on page 25.

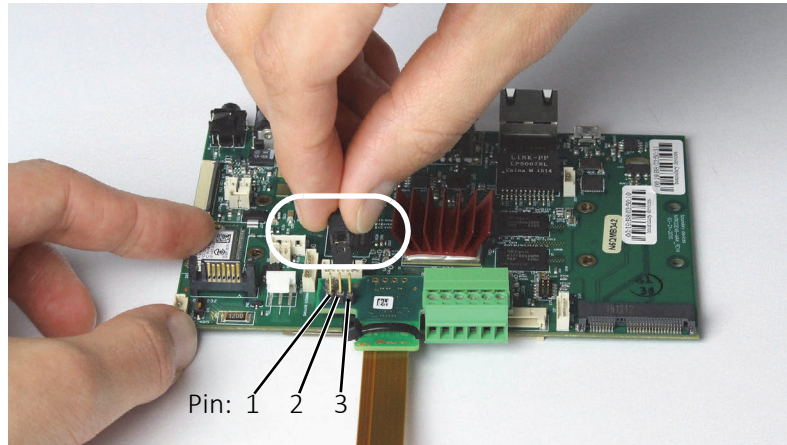

Figure 22: Setting the power mode

Continue with [Connecting the camera](#) on page 32.

Nitrogen powered	Pin	Externally powered
Power over Nitrogen6_MAX	1	
	2	Power over the I/Os terminal
	3	

Table 10: Jumper position and power modes

Connecting the camera

1. To finally connect the FPC cable to the camera, again follow the instructions in [Connecting FPC cables to Hirose FPC connectors](#) on page 25.
2. Provide strain relief to protect the FPC cable and the FPC connectors from damage and to avoid short circuits.

Your Alvium CSI-2 camera is connected to the embedded board.

Installing adapter boards for Wandboard i.MX6 Solo and Dual



NOTICE

Damage to electronics

- Disconnect all power supplies before installing the adapter board.
- Reconnect power only after installation is complete.



Components in images

Actual fastening material, such as bolts and spacers, may look different than components shown in the instruction images.

Connecting the embedded board

1. Remove the two front bolts (a) of the top board.
Keep the bolts to be reused later.

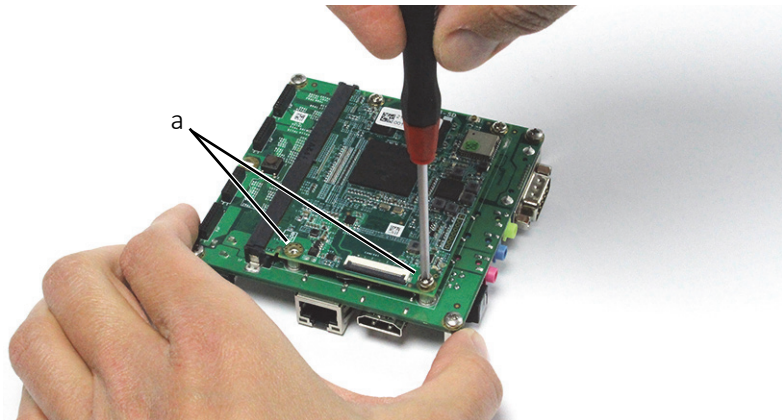

Figure 23: Removing top board bolts

2. Following the instructions in [Connecting FPC cables to Hirose FPC connectors](#) on page 25, connect the FPC cable of the adapter board to FPC connector of the embedded board.

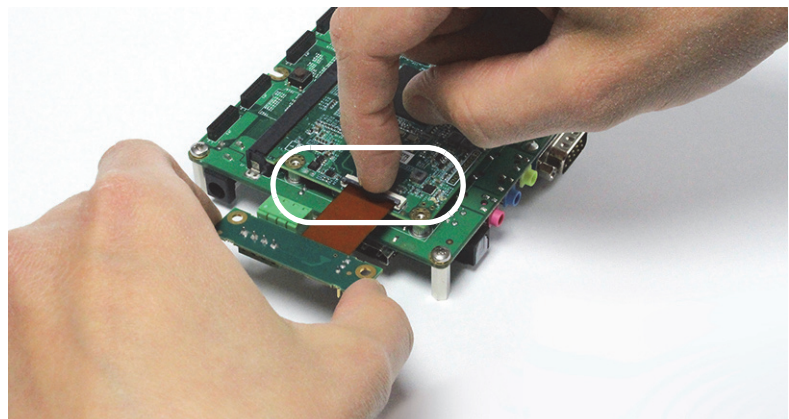

Figure 24: Connecting the adapter board

3. Continue with [Mounting the adapter board](#) on page 34.

Mounting the adapter board

1. Screw in the spacer bolts (a) through the spacer sleeves (b) at 1.2 Nm maximum torque.

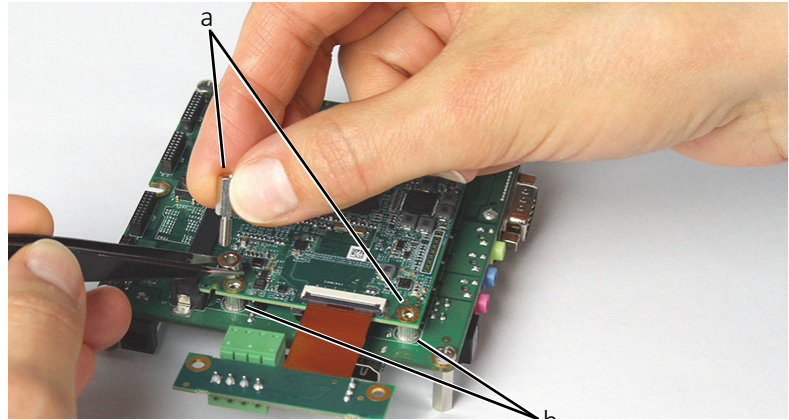

Figure 25: Screwing in the spacer bolts

2. Fold the adapter board until the mounting holes of the adapter board (b) and the spacer bolt (c) match.

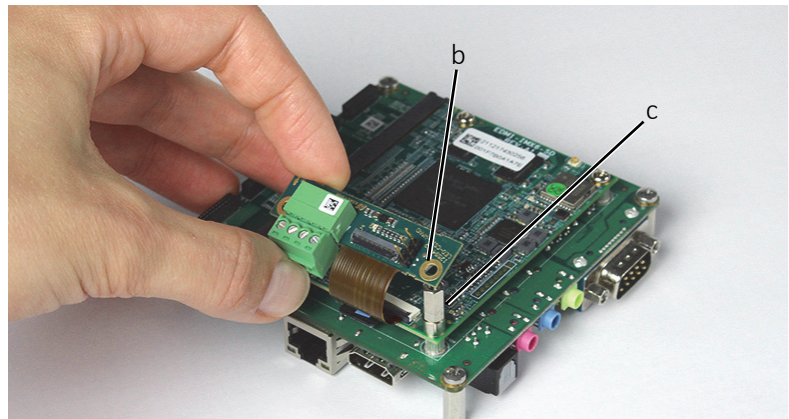

Figure 26: Bringing the adapter board into position

3. Screw in the two bolts (d) you removed before, at 1.2 Nm maximum torque.
4. For **handling microSD cards**, continue with [Removing and inserting microSD cards](#) on page 35.
For **connecting to the camera**, continue with [Connecting Wandboard i.MX6 series boards to the camera](#) on page 41.
For **setting the power mode**, continue with [Setting power modes for Wandboard i.MX6 series](#) on page 40.

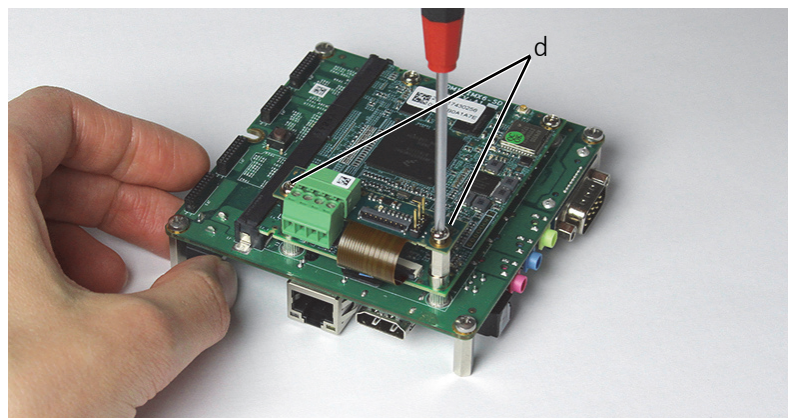

Figure 27: Tightening bolts for the adapter board

Removing and inserting microSD cards



NOTICE

Damage to the FPC cable or to the FPC connector

Keep away from the FPC cable when you remove or insert SD cards.

Push the microSD card slightly with your fingertip.

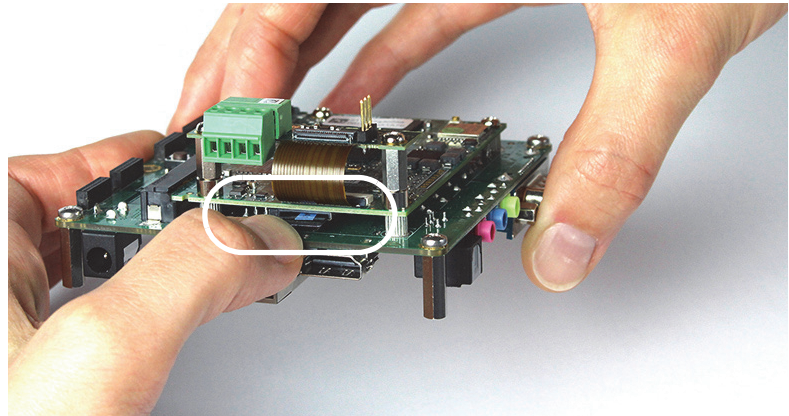

Figure 28: Pushing in the microSD card

Installing adapter boards for Wandboard i.MX6 Quad and QuadPlus



NOTICE

Damage to electronics

- Disconnect all power supplies before installing the adapter board.
- Reconnect power only after installation is complete.



Components in images

Actual fastening material, such as bolts and spacers, may look different than components shown in the instruction images.

Removing the embedded board's heat sink

1. Remove the four bolts (a) holding the heat sink (b). Keep the bolts to be reused later.

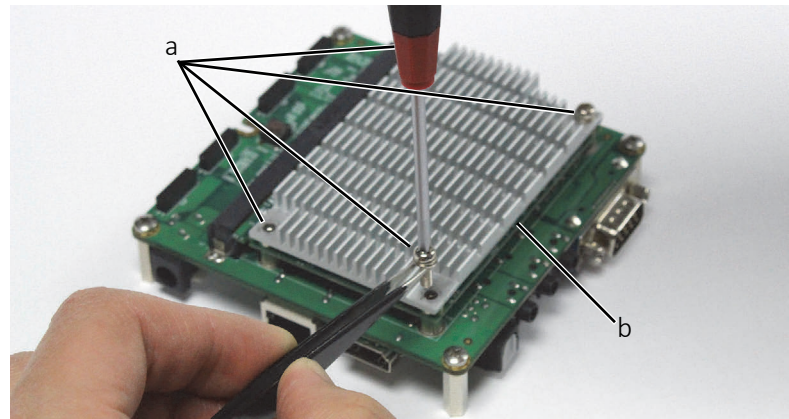

Figure 29: Removing the heat sink bolts

2. Remove the heat sink (b) and the four spacer sleeves (c). Keep the spacer sleeves to be reused later.

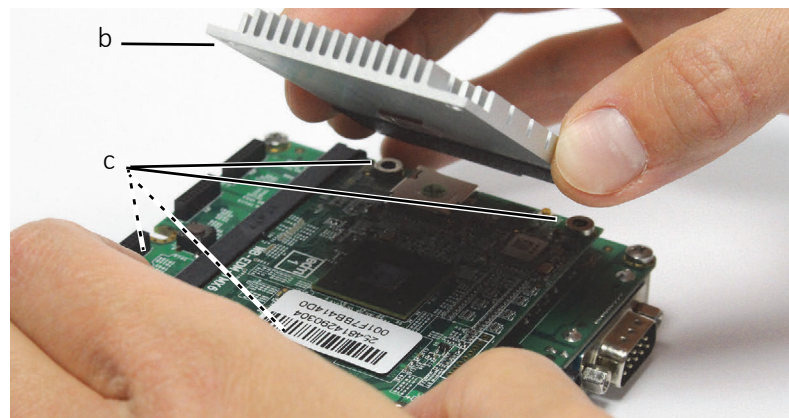

Figure 30: Removing the heat sink and spacer sleeves

3. Continue with [Connecting the embedded board](#) on page 37.

Connecting the embedded board

1. Following the instructions in [Connecting FPC cables to Hirose FPC connectors](#) on page 25, connect the CSI-2 FPC cable of the adapter board to CSI-2 FPC connector the embedded board.



Figure 31: Connecting adapter board and embedded board

2. Position the four spacer sleeves (a) that you removed before back into place.

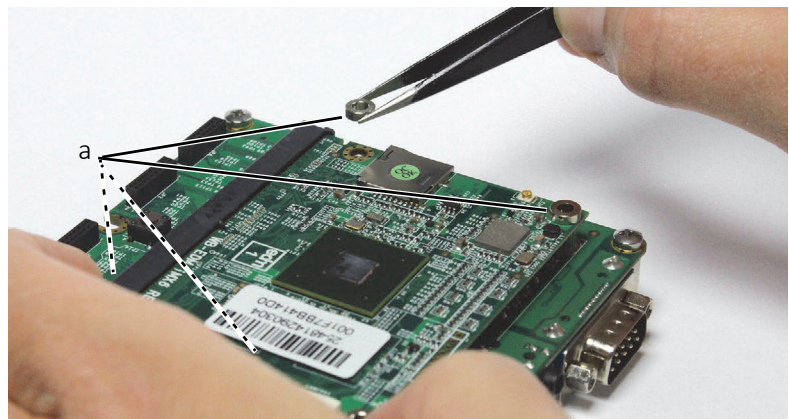

Figure 32: Repositioning the spacer sleeves

3. Place the heat sink onto the spacers with mounting holes matching.
4. Screw in the two back bolts (b) of the heat sink at 1.2 Nm maximum torque.
5. Continue with [Mounting the adapter board](#) on page 38.

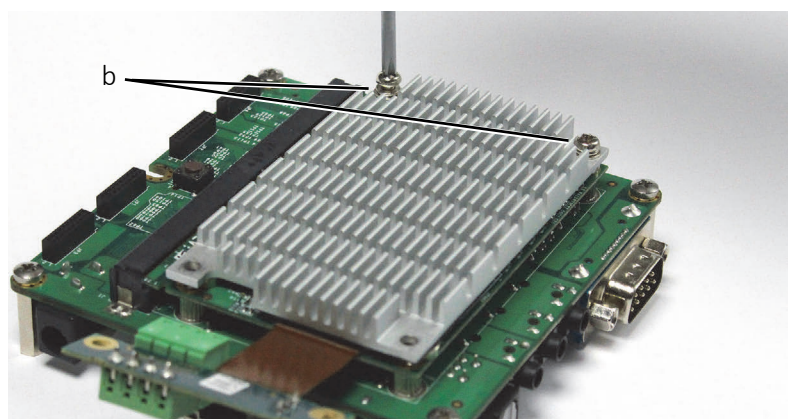

Figure 33: Placing the heat sink and fastening the back bolts

Mounting the adapter board

1. Screw in the spacer bolts (a) at 1.2 Nm maximum torque.

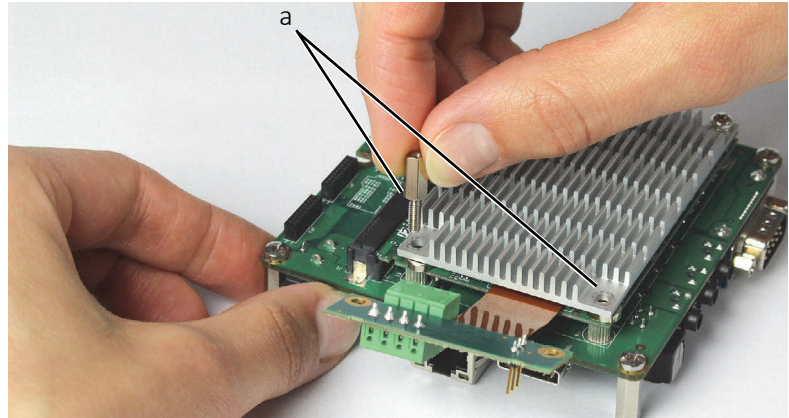

Figure 34: Repositioning the left spacer sleeve on the heat sink

2. Fold the adapter board so that the mounting holes (b) of the adapter board and spacer bolts match.
3. Screw in the bolts (b) you removed before, at 1.2 Nm maximum torque.
4. For **connecting to the camera**, continue with [Connecting Wandboard i.MX6 series boards to the camera](#) on page 41.

For **setting the power mode**, continue with [Setting power modes for Wandboard i.MX6 series](#) on page 40.

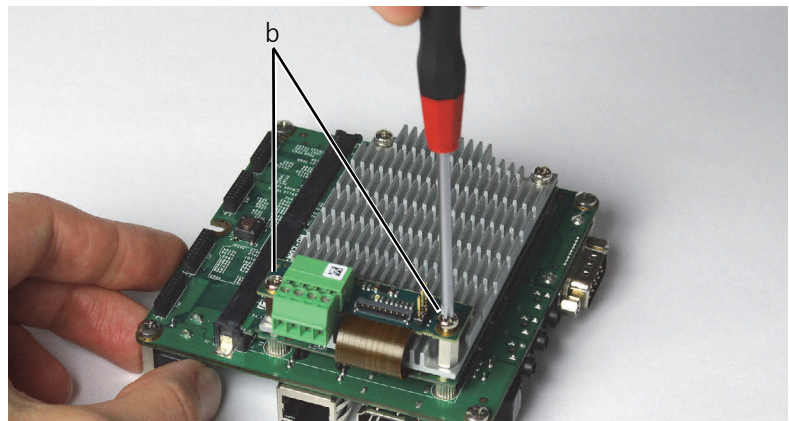

Figure 35: Completing the adapter board mounting

Removing and inserting microSD cards

Push the microSD card slightly with your fingertip.

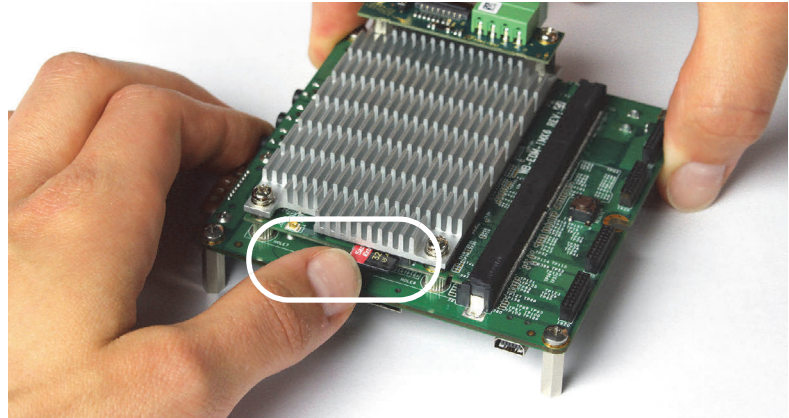

Figure 36: Pushing in the microSD card

Setting power modes for Wandboard i.MX6 series

Set jumper J3 to the corresponding position to select the power mode.

For pin assignment, see [Electronic schematics](#) on page 22.

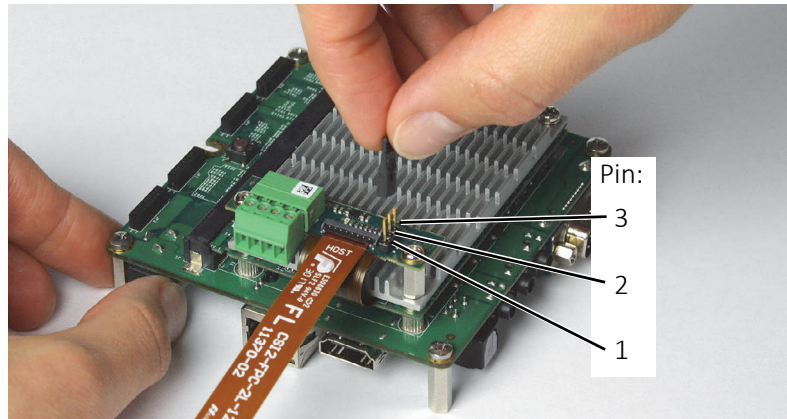

Figure 37: Setting the power mode

Wandboard powered	Pin	Externally powered
Power over Wandboard i.MX6	1	
	2	Power over the I/Os terminal
	3	

Table 11: Jumper position and power modes

Connecting Wandboard i.MX6 series boards to the camera

1. Following the instructions in [Connecting FPC cables to Hirose FPC connectors](#) on page 25, connect the FPC cable of the camera to FPC connector the embedded board.
2. To finally connect the FPC cable to the camera, again follow the instructions in [Connecting FPC cables to Hirose FPC connectors](#) on page 25.
3. Provide strain relief to protect the FPC cable and the FPC connectors from damage and to avoid short circuits.

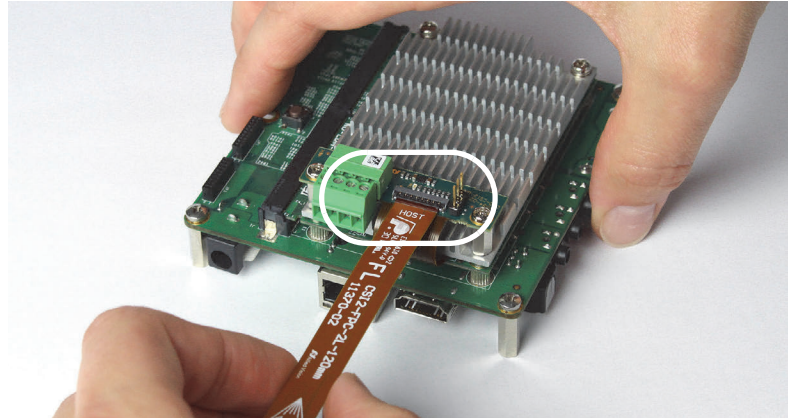

Figure 38: Connecting the camera FPC cable

Your Alvium CSI-2 camera is connected to the embedded board.