

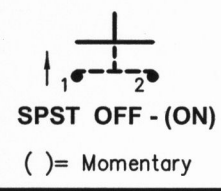

THIS INFORMATION IS CONFIDENTIAL AND PROPRIETARY TO CW INDUSTRIES INCORPORATED AND ITS AFFILIATES. IT MAY NOT BE DISCLOSED TO ANYONE, OTHER THAN CW INDUSTRIES PERSONNEL, WITHOUT WRITTEN AUTHORIZATION FROM CW INDUSTRIES INCORPORATED, SOUTHAMPTON, PENNSYLVANIA USA.

Rating	3A. 125V , 1. 5A 250V AC		Mounting Hole	
Contact Resistance	50m ohm max.			
Insulation Resistance	DC 500V 100M ohm min.			
Dielectric Strength	AC 1000V 1 minute			
BASE COLOR: Black BUTTON COLOR: Black			Cut-Out 3 mm thk. max	

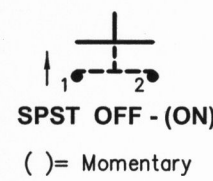
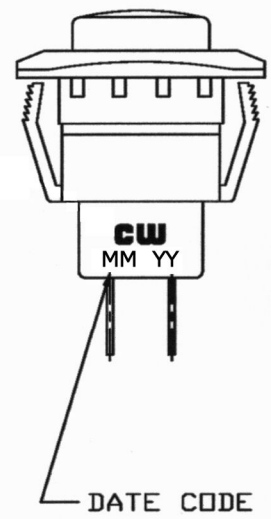
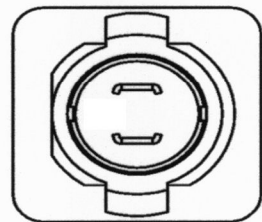
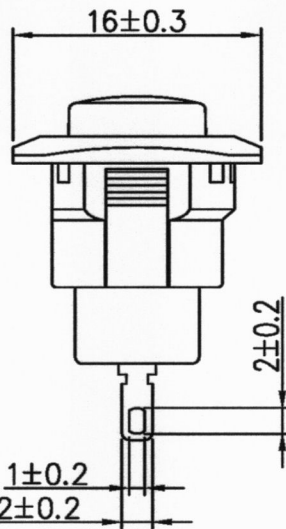
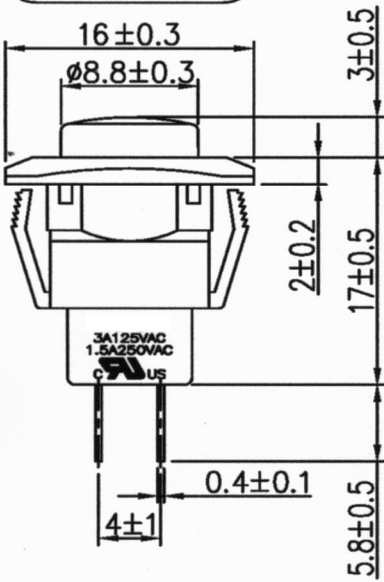
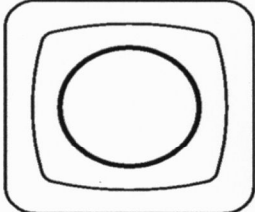

RoHS Compliant

 <b>CW INDUSTRIES</b> Southampton, Pa. 18966 Tel 215.355.7080/www.cwind.com	Date Drawn: 1/27/10	Rev. 0	Unit: mm	Checked By: G. Guld
	Title: <b>PUSH BUTTON SWITCH</b>		CW P/N: <b>GPB510A05BB</b>	