

## FEATURES

- Single 18-bit DAC,  $\pm 0.5$  LSB INL
- 7.5 nV/ $\sqrt{\text{Hz}}$  noise spectral density
- 0.05 LSB long-term linearity stability
- $< 0.05$  ppm/ $^{\circ}\text{C}$  temperature drift
- 1  $\mu\text{s}$  settling time
- 1.4 nV-sec glitch impulse
- 20-lead TSSOP package
- Wide power supply range of up to  $\pm 16.5$  V
- 35 MHz Schmitt triggered digital interface
- 1.8 V compatible digital interface

## ENHANCED PRODUCT FEATURES

- Supports defense and aerospace applications (AQEC standard)
- Military temperature range ( $-55^{\circ}\text{C}$  to  $+125^{\circ}\text{C}$ )
- Controlled manufacturing baseline
- One assembly/test site
- One fabrication site
- Product change notification
- Qualification data available on request

## APPLICATIONS

- Medical instrumentation
- Test and measurement
- Industrial control
- Scientific and aerospace instrumentation
- Data acquisition systems
- Digital gain and offset adjustment
- Power supply control

## GENERAL DESCRIPTION

The **AD5781-EP**<sup>1</sup> is a single 18-bit, unbuffered voltage output digital-to-analog converter (DAC) that operates from a bipolar supply of up to 33 V. The **AD5781-EP** accepts a positive reference input range of 5 V to  $V_{DD} - 2.5$  V and a negative reference input range of  $V_{SS} + 2.5$  V to 0 V. The **AD5781-EP** offers a relative accuracy specification of  $\pm 0.5$  LSB maximum, and operation is guaranteed monotonic with a  $\pm 0.5$  LSB differential nonlinearity (DNL) maximum specification.

The part uses a versatile 3-wire serial interface that operates at clock rates of up to 35 MHz and is compatible with standard serial peripheral interface (SPI), QSPI™, MICROWIRE™, and DSP interface standards. The part incorporates a power-on reset circuit that ensures that the DAC output powers up to 0 V and in a known output impedance

<sup>1</sup> Protected by U.S. Patent No. 8,089,380, and other patents are pending.

Rev. B

[Document Feedback](#)

Information furnished by Analog Devices is believed to be accurate and reliable. However, no responsibility is assumed by Analog Devices for its use, nor for any infringements of patents or other rights of third parties that may result from its use. Specifications subject to change without notice. No license is granted by implication or otherwise under any patent or patent rights of Analog Devices. Trademarks and registered trademarks are the property of their respective owners.

## FUNCTIONAL BLOCK DIAGRAM

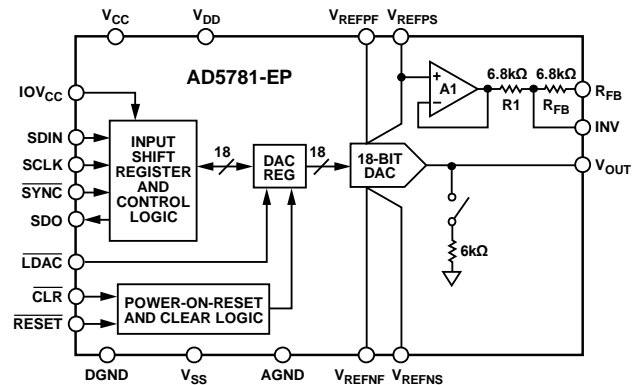

Figure 1.

## COMPANION PRODUCTS

Ultra precision op amps: [AD8675](#), [AD8676](#)

High voltage op amp: [ADA4898-1](#)

Additional companion products on the [AD5781 product page](#)

Table 1. Related Devices

| Part No.                        | Description                    |
|---------------------------------|--------------------------------|
| <a href="#">AD5791</a>          | 20-bit, 1 ppm accurate DAC     |
| <a href="#">AD5541A/AD5542A</a> | 16-bit, 1 LSB accurate 5 V DAC |

state and remains in this state until a valid write to the device takes place.

The part provides an output clamp feature that places the output in a defined load state.

The **AD5781-EP** is available in a compact, 20-lead TSSOP package and operates at the extended automotive temperature range of  $-55^{\circ}\text{C}$  to  $+125^{\circ}\text{C}$ . Additional application and technical information can be found in the **AD5781** data sheet.

## PRODUCT HIGHLIGHTS

1. True 18-Bit Accuracy.
2. Wide Power Supply Range Up to  $\pm 16.5$  V.
3.  $-55^{\circ}\text{C}$  to  $+125^{\circ}\text{C}$  Operating Temperature Range.
4. Low 7.5 nV/ $\sqrt{\text{Hz}}$  Noise.
5. Low 0.05 ppm/ $^{\circ}\text{C}$  Temperature Drift.

**TABLE OF CONTENTS**

|                                 |   |  |    |
|---------------------------------|---|--|----|
| Features .....                  | 1 | Specifications .....                             | 3  |
| Enhanced Product Features ..... | 1 | Timing Characteristics .....                     | 5  |
| Applications.....               | 1 | Absolute Maximum Ratings .....                   | 7  |
| Functional Block Diagram .....  | 1 | ESD Caution.....                                 | 7  |
| Companion Products .....        | 1 | Pin Configuration and Function Description ..... | 8  |
| General Description .....       | 1 | Typical Performance Characteristics .....        | 9  |
| Product Highlights .....        | 1 | Outline Dimensions .....                         | 17 |
| Revision History .....          | 2 | Ordering Guide .....                             | 17 |

**REVISION HISTORY**

**4/2018—Rev. A to Rev. B**

|  |    |
|--|----|
| Changes to Features Section and Enhanced Product Features Section..... | 1  |
| Changes to Ordering Guide .....  | 17 |

**7/2013—Rev. 0 to Rev. A**

|  |   |
|--|---|
| Changes to t <sub>1</sub> Test Conditions/Comments and Endnote 2 ..... | 5 |
| Deleted Figure 4.....  | 7 |

**2/2012—Revision 0: Initial Version**

## SPECIFICATIONS

$V_{DD} = +12.5\text{ V to }+16.5\text{ V}$ ,  $V_{SS} = -16.5\text{ V to }-12.5\text{ V}$ ,  $V_{REFP} = +10\text{ V}$ ,  $V_{REFN} = -10\text{ V}$ ,  $V_{CC} = +2.7\text{ V to }+5.5\text{ V}$ ,  $IOV_{CC} = +1.71\text{ V to }+5.5\text{ V}$ ,  $R_L = \text{unloaded}$ ,  $C_L = \text{unloaded}$ ,  $T_{MIN}$  to  $T_{MAX}$ , unless otherwise noted.

Table 2.

| Parameter <sup>1</sup>                                | Min        | Typ    | Max        | Unit       | Test Conditions/Comments   |
|---|------------|--------|------------|------------|--|
| <b>STATIC PERFORMANCE<sup>2</sup></b>                 |            |        |            |            |  |
| Resolution  | 18         |        |            | Bits       |  |
| Integral Nonlinearity Error (Relative Accuracy)       | -0.5       | ±0.25  | +0.5       | LSB        | $V_{REFP} = +10\text{ V}$ , $V_{REFN} = -10\text{ V}$  |
| Differential Nonlinearity Error                       | -0.5       | ±0.25  | +0.5       | LSB        | $V_{REFP} = +10\text{ V}$ , $V_{REFN} = 0\text{ V}^3$  |
|   | -1         | ±0.5   | +1         | LSB        | $V_{REFP} = +5\text{ V}$ , $V_{REFN} = 0\text{ V}^3$   |
|   | -0.5       | ±0.25  | +0.5       | LSB        | $V_{REFP} = +10\text{ V}$ , $V_{REFN} = -10\text{ V}$  |
|   | -0.5       | ±0.25  | +0.5       | LSB        | $V_{REFP} = +10\text{ V}$ , $V_{REFN} = 0\text{ V}$  |
| Linearity Error Long-Term Stability <sup>4</sup>      | -1         | ±0.5   | +1         | LSB        | $V_{REFP} = +5\text{ V}$ , $V_{REFN} = 0\text{ V}$   |
|   |            | 0.04   |            | LSB        | After 500 hours at $T_A = 125^\circ\text{C}$   |
|   |            | 0.05   |            | LSB        | After 1000 hours at $T_A = 125^\circ\text{C}$  |
| Full-Scale Error                                      |            | 0.03   |            | LSB        | After 1000 hours at $T_A = 100^\circ\text{C}$  |
|   | -1.75      | ±0.25  | +1.75      | LSB        | $V_{REFP} = +10\text{ V}$ , $V_{REFN} = -10\text{ V}^3$  |
|   | -2.75      | ±0.062 | +2.75      | LSB        | $V_{REFP} = +10\text{ V}$ , $V_{REFN} = 0\text{ V}^3$  |
|   | -5.25      | ±0.2   | +5.25      | LSB        | $V_{REFP} = +5\text{ V}$ , $V_{REFN} = 0\text{ V}^3$   |
| Full-Scale Error Temperature Coefficient              | -1         | ±0.25  | +1         | LSB        | $V_{REFP} = +10\text{ V}$ , $V_{REFN} = -10\text{ V}^3$ , $T_A = 0^\circ\text{C to }105^\circ\text{C}$ |
|   | -1         | ±0.062 | +1         | LSB        | $V_{REFP} = 10\text{ V}$ , $V_{REFN} = 0\text{ V}^3$ , $T_A = 0^\circ\text{C to }105^\circ\text{C}$    |
|   | -1.5       | ±0.2   | +1.5       | LSB        | $V_{REFP} = 5\text{ V}$ , $V_{REFN} = 0\text{ V}^3$ , $T_A = 0^\circ\text{C to }105^\circ\text{C}$     |
| Zero-Scale Error                                      | -1.75      | ±0.025 | +1.75      | ppm FSR/°C | $V_{REFP} = +10\text{ V}$ , $V_{REFN} = -10\text{ V}^3$  |
| Zero-Scale Error Temperature Coefficient <sup>3</sup> | -2.5       | ±0.38  | +2.5       | LSB        | $V_{REFP} = +10\text{ V}$ , $V_{REFN} = 0\text{ V}^3$  |
|   | -5.25      | ±0.19  | +5.25      | LSB        | $V_{REFP} = +5\text{ V}$ , $V_{REFN} = 0\text{ V}^3$   |
|   | -1         | ±0.025 | +1         | LSB        | $V_{REFP} = +10\text{ V}$ , $V_{REFN} = -10\text{ V}^3$ , $T_A = 0^\circ\text{C to }105^\circ\text{C}$ |
|   | -1         | ±0.38  | +1         | LSB        | $V_{REFP} = 10\text{ V}$ , $V_{REFN} = 0\text{ V}^3$ , $T_A = 0^\circ\text{C to }105^\circ\text{C}$    |
| Gain Error  | -1.5       | ±0.19  | +1.5       | LSB        | $V_{REFP} = 5\text{ V}$ , $V_{REFN} = 0\text{ V}^3$ , $T_A = 0^\circ\text{C to }105^\circ\text{C}$     |
|   |            | ±0.04  |            | ppm FSR/°C |  |
|   |            | ±0.02  |            | ppm FSR/°C |  |
| Gain Error Temperature Coefficient <sup>3</sup>       | -6         | ±0.3   | +6         | ppm FSR    | $V_{REFP} = +10\text{ V}$ , $V_{REFN} = -10\text{ V}^3$  |
|   | -10        | ±0.4   | +10        | ppm FSR    | $V_{REFP} = +10\text{ V}$ , $V_{REFN} = 0\text{ V}^3$  |
|   | -20        | ±0.4   | +20        | ppm FSR    | $V_{REFP} = +5\text{ V}$ , $V_{REFN} = 0\text{ V}^3$   |
| R1, R <sub>FB</sub> Matching                          |            | ±0.04  |            | ppm FSR/°C |  |
|   |            | 0.01   |            | %          |  |
| <b>OUTPUT CHARACTERISTICS<sup>3</sup></b>             |            |        |            |            |  |
| Output Voltage Range                                  | $V_{REFN}$ |        | $V_{REFP}$ | V          |  |
| Output Slew Rate                                      |            | 50     |            | V/μs       | Unbuffered output, 10 MΩ  20 pF load   |
| Output Voltage Settling Time                          |            | 1      |            | μs         | 10V step to 0.02%, using <a href="#">AD845</a> buffer in unity-gain mode                               |
| Output Noise Spectral Density                         |            | 1      |            | μs         | 125 code step to ±1 LSB <sup>5</sup>   |
|   |            | 7.5    |            | nV/√Hz     | At 1 kHz, DAC code = midscale  |
|   |            | 7.5    |            | nV/√Hz     | At 10 kHz, DAC code = midscale   |
| Output Voltage Noise                                  |            | 7.5    |            | nV/√Hz     | At 100 kHz, DAC code = midscale  |
|   |            | 1.1    |            | μV p-p     | DAC code = midscale, 0.1 Hz to 10 Hz bandwidth <sup>6</sup>  |

| Parameter <sup>1</sup>                          | Min                       | Typ       | Max                     | Unit            | Test Conditions/Comments   |
|---|---------------------------|-----------|-------------------------|-----------------|--|
| Midscale Glitch Impulse <sup>7</sup>            |                           | 3.1       |                         | nV-sec          | $V_{REFP} = +10\text{ V}, V_{REFN} = -10\text{ V}$                 |
|   |                           | 1.7       |                         | nV-sec          | $V_{REFP} = +10\text{ V}, V_{REFN} = 0\text{ V}$                   |
|   |                           | 1.4       |                         | nV-sec          | $V_{REFP} = +5\text{ V}, V_{REFN} = 0\text{ V}$                    |
| MSB Segment Glitch Impulse <sup>7</sup>         |                           | 9.1       |                         | nV-sec          | $V_{REFP} = +10\text{ V}, V_{REFN} = -10\text{ V}$ , see Figure 42 |
|   |                           | 3.6       |                         | nV-sec          | $V_{REFP} = 10\text{ V}, V_{REFN} = 0\text{ V}$ , see Figure 43    |
|   |                           | 1.9       |                         | nV-sec          | $V_{REFP} = 5\text{ V}, V_{REFN} = 0\text{ V}$ , see Figure 44     |
| Output Enabled Glitch Impulse                   |                           | 45        |                         | nV-sec          | On removal of output ground clamp                                  |
| Digital Feedthrough                             |                           | 0.4       |                         | nV-sec          |  |
| DC Output Impedance (Normal Mode)               |                           | 3.4       |                         | k $\Omega$      |  |
| DC Output Impedance (Output Clamped to Ground)  |                           | 6         |                         | k $\Omega$      |  |
| Spurious Free Dynamic Range                     |                           | 100       |                         | dB              | 1 kHz tone, 10 kHz sample rate                                     |
| Total Harmonic Distortion                       |                           | 97        |                         | dB              | 1 kHz tone, 10 kHz sample rate                                     |
| REFERENCE INPUTS <sup>3</sup>                   |                           |           |                         |                 |  |
| $V_{REFP}$ Input Range                          | 5                         |           | $V_{DD} - 2.5\text{ V}$ | V               |  |
| $V_{REFN}$ Input Range                          | $V_{SS} + 2.5\text{ V}$   |           | 0                       | V               |  |
| DC Input Impedance                              | 5                         | 6.6       |                         | k $\Omega$      | $V_{REFP}, V_{REFN}$ , code dependent, typical at mid-scale code   |
| Input Capacitance                               |                           | 15        |                         | pF              | $V_{REFP}, V_{REFN}$   |
| LOGIC INPUTS <sup>3</sup>                       |                           |           |                         |                 |  |
| Input Current <sup>8</sup>                      | -1                        |           | +1                      | $\mu\text{A}$   |  |
| Input Low Voltage, $V_{IL}$                     |                           |           | $0.3 \times IOV_{CC}$   | V               | $IOV_{CC} = 1.71\text{ V to }5.5\text{ V}$                         |
| Input High Voltage, $V_{IH}$                    | $0.7 \times IOV_{CC}$     |           |                         | V               | $IOV_{CC} = 1.71\text{ V to }5.5\text{ V}$                         |
| Pin Capacitance                                 |                           | 5         |                         | pF              |  |
| LOGIC OUTPUT (SDO) <sup>3</sup>                 |                           |           |                         |                 |  |
| Output Low Voltage, $V_{OL}$                    |                           |           | 0.4                     | V               | $IOV_{CC} = 1.71\text{ V to }5.5\text{ V}$ , sinking 1 mA          |
| Output High Voltage, $V_{OH}$                   | $IOV_{CC} - 0.5\text{ V}$ |           |                         | V               | $IOV_{CC} = 1.71\text{ V to }5.5\text{ V}$ , sourcing 1 mA         |
| High Impedance Leakage Current                  |                           |           | $\pm 1$                 | $\mu\text{A}$   |  |
| High Impedance Output Capacitance               |                           | 3         |                         | pF              |  |
| POWER REQUIREMENTS                              |                           |           |                         |                 |  |
| $V_{DD}$  | 7.5                       |           | $V_{SS} + 33$           | V               |  |
| $V_{SS}$  | $V_{DD} - 33$             |           | -2.5                    | V               |  |
| $V_{CC}$  | 2.7                       |           | 5.5                     | V               |  |
| $IOV_{CC}$                                      | 1.71                      |           | 5.5                     | V               | $IOV_{CC} \leq V_{CC}$   |
| $I_{DD}$  |                           | 4.2       | 5.2                     | mA              |  |
| $I_{SS}$  |                           | 4         | 4.9                     | mA              |  |
| $I_{CC}$  |                           | 600       | 900                     | $\mu\text{A}$   |  |
| $IOI_{CC}$                                      |                           | 52        | 140                     | $\mu\text{A}$   | SDO disabled   |
| DC Power Supply Rejection Ratio <sup>3, 9</sup> |                           | $\pm 0.6$ |                         | $\mu\text{V/V}$ | $V_{DD} \pm 10\%$ , $V_{SS} = 15\text{ V}$                         |
|   |                           | $\pm 0.6$ |                         | $\mu\text{V/V}$ | $V_{SS} \pm 10\%$ , $V_{DD} = 15\text{ V}$                         |
| AC Power Supply Rejection Ratio <sup>3</sup>    |                           | 95        |                         | dB              | $V_{DD} \pm 200\text{ mV}$ , 50 Hz/60 Hz, $V_{SS} = -15\text{ V}$  |
|   |                           | 95        |                         | dB              | $V_{SS} \pm 200\text{ mV}$ , 50 Hz/60 Hz, $V_{DD} = 15\text{ V}$   |

<sup>1</sup> Temperature range:  $-55^{\circ}\text{C}$  to  $+125^{\circ}\text{C}$ , typical conditions:  $T_A = 25^{\circ}\text{C}$ ,  $V_{DD} = +15\text{ V}$ ,  $V_{SS} = -15\text{ V}$ ,  $V_{REFP} = +10\text{ V}$ ,  $V_{REFN} = -10\text{ V}$ .

<sup>2</sup> Performance characterized with [AD8676BRZ](#) voltage reference buffers and [AD8675ARZ](#) output buffer.

<sup>3</sup> Guaranteed by design and characterization; not production tested.

<sup>4</sup> Linearity error refers to both INL error and DNL error; either parameter can be expected to drift by the amount specified after the length of time specified.

<sup>5</sup> [AD5791-EP](#) configured in  $\times 2$  gain mode, 25 pF compensation capacitor on [AD797](#).

<sup>6</sup> Includes noise contribution from [AD8676BRZ](#) voltage reference buffers.

<sup>7</sup> The [AD5781-EP](#) is configured in the bias compensation mode with a low-pass RC filter on the output.  $R = 300\ \Omega$ ,  $C = 143\ \text{pF}$  (total capacitance seen by the output buffer, lead capacitance, and so forth).

<sup>8</sup> Current flowing in an individual logic pin.

<sup>9</sup> Includes PSRR of [AD8676BRZ](#) voltage reference buffers.

**TIMING CHARACTERISTICS**

$V_{CC} = 2.7\text{ V to }5.5\text{ V}$ ; all specifications  $T_{MIN}$  to  $T_{MAX}$ , unless otherwise noted.

**Table 3.**

| Parameter | Limit <sup>1</sup>                         |   | Unit   | Test Conditions/Comments  |
|-----------|--|---|--------|---|
|           | $IOV_{CC} = 1.71\text{ V to }3.3\text{ V}$ | $IOV_{CC} = 3.3\text{ V to }5.5\text{ V}$ |        |   |
| $t_1^2$   | 40   | 28  | ns min | SCLK cycle time   |
|           | 92   | 60  | ns min | SCLK cycle time (readback mode)   |
| $t_2$     | 15   | 10  | ns min | SCLK high time  |
| $t_3$     | 9  | 5   | ns min | SCLK low time   |
| $t_4$     | 5  | 5   | ns min | $\overline{SYNC}$ to SCLK falling edge setup time                                   |
| $t_5$     | 2  | 2   | ns min | SCLK falling edge to $\overline{SYNC}$ rising edge hold time                        |
| $t_6$     | 48   | 40  | ns min | Minimum $\overline{SYNC}$ high time   |
| $t_7$     | 8  | 6   | ns min | $\overline{SYNC}$ rising edge to next SCLK falling edge ignore                      |
| $t_8$     | 9  | 7   | ns min | Data setup time   |
| $t_9$     | 12   | 7   | ns min | Data hold time  |
| $t_{10}$  | 13   | 10  | ns min | $\overline{LDAC}$ falling edge to $\overline{SYNC}$ falling edge                    |
| $t_{11}$  | 20   | 16  | ns min | $\overline{SYNC}$ rising edge to $\overline{LDAC}$ falling edge                     |
| $t_{12}$  | 14   | 11  | ns min | $\overline{LDAC}$ pulse width low   |
| $t_{13}$  | 130  | 130                                       | ns typ | $\overline{LDAC}$ falling edge to output response time                              |
| $t_{14}$  | 130  | 130                                       | ns typ | $\overline{SYNC}$ rising edge to output response time ( $\overline{LDAC}$ tied low) |
| $t_{15}$  | 50   | 50  | ns min | $\overline{CLR}$ pulse width low  |
| $t_{16}$  | 140  | 140                                       | ns typ | $\overline{CLR}$ pulse activation time  |
| $t_{17}$  | 0  | 0   | ns min | $\overline{SYNC}$ falling edge to first SCLK rising edge                            |
| $t_{18}$  | 65   | 60  | ns max | $\overline{SYNC}$ rising edge to SDO tristate ( $C_L = 50\text{ pF}$ )              |
| $t_{19}$  | 62   | 45  | ns max | SCLK rising edge to SDO valid ( $C_L = 50\text{ pF}$ )                              |
| $t_{20}$  | 0  | 0   | ns min | $\overline{SYNC}$ rising edge to SCLK rising edge ignore                            |
| $t_{21}$  | 35   | 35  | ns typ | $\overline{RESET}$ pulse width low  |
| $t_{22}$  | 150  | 150                                       | ns typ | $\overline{RESET}$ pulse activation time  |

<sup>1</sup> All input signals are specified with  $t_r = t_f = 1\text{ ns/V}$  (10% to 90% of  $IOV_{CC}$ ) and timed from a voltage level of  $(V_{IL} + V_{IH})/2$ .

<sup>2</sup> Maximum SCLK frequency is 35 MHz for write mode and 16 MHz for readback mode.

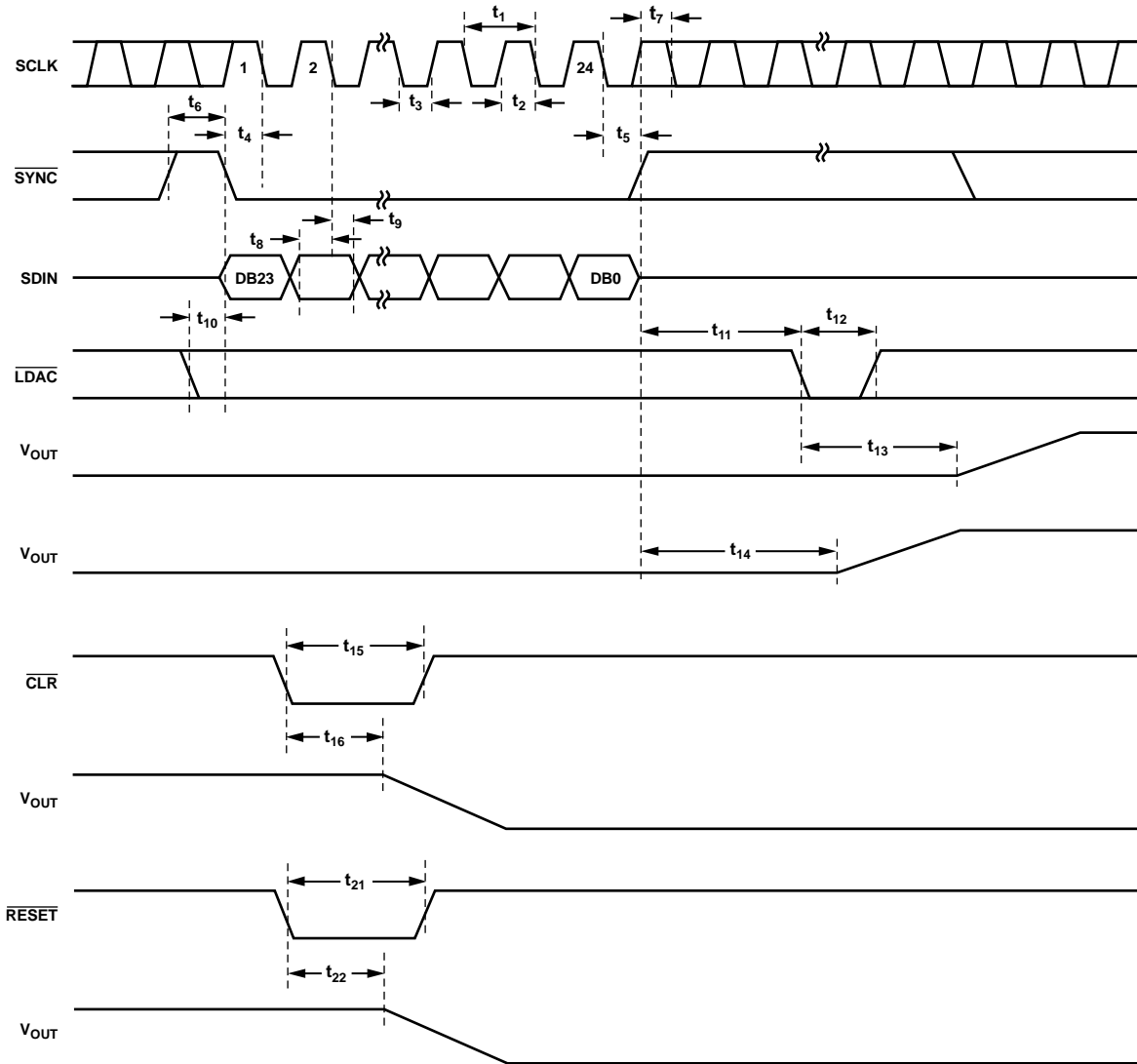

Figure 2. Write Mode Timing Diagram

10454-002

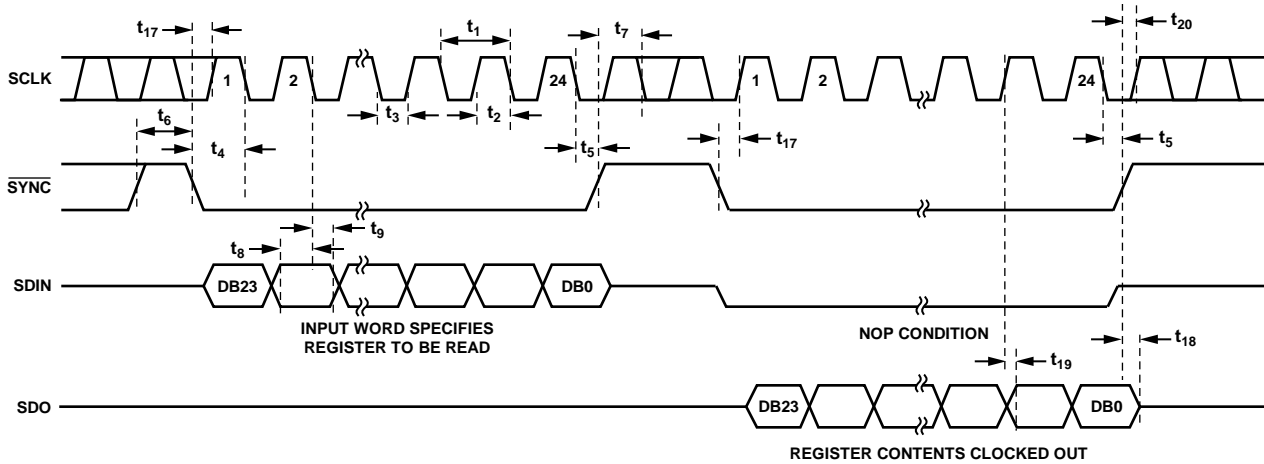

Figure 3. Readback Mode Timing Diagram

10454-003

## ABSOLUTE MAXIMUM RATINGS

$T_A = 25^\circ\text{C}$ , unless otherwise noted. Transient currents of up to 100 mA do not cause SCR latch-up.

Table 4.

| Parameter  | Rating  |
|--|---|
| $V_{DD}$ to AGND                                 | -0.3 V to +34 V   |
| $V_{SS}$ to AGND                                 | -34 V to +0.3 V   |
| $V_{DD}$ to $V_{SS}$                             | -0.3 V to +34 V   |
| $V_{CC}$ to DGND                                 | -0.3 V to +7 V  |
| $IOV_{CC}$ to DGND                               | -0.3 V to $V_{CC} + 3\text{ V}$ or +7 V (whichever is less)     |
| Digital Inputs to DGND                           | -0.3 V to $IOV_{CC} + 0.3\text{ V}$ or +7 V (whichever is less) |
| $V_{OUT}$ to AGND                                | -0.3 V to $V_{DD} + 0.3\text{ V}$                               |
| $V_{REFPF}$ to AGND                              | -0.3 V to $V_{DD} + 0.3\text{ V}$                               |
| $V_{REFPS}$ to AGND                              | -0.3 V to $V_{DD} + 0.3\text{ V}$                               |
| $V_{REFNF}$ to AGND                              | $V_{SS} - 0.3\text{ V}$ to +0.3 V                               |
| $V_{REFNS}$ to AGND                              | $V_{SS} - 0.3\text{ V}$ to +0.3 V                               |
| DGND to AGND                                     | -0.3 V to +0.3 V  |
| Operating Temperature Range, $T_A$<br>Industrial | $-55^\circ\text{C}$ to $+125^\circ\text{C}$                     |
| Storage Temperature Range                        | $-65^\circ\text{C}$ to $+150^\circ\text{C}$                     |
| Maximum Junction Temperature, $T_{J\text{ max}}$ | $150^\circ\text{C}$   |
| Power Dissipation                                | $(T_{J\text{ max}} - T_A)/\theta_{JA}$                          |
| TSSOP Package                                    |   |
| $\theta_{JA}$ Thermal Impedance                  | $143^\circ\text{C/W}$   |
| $\theta_{JC}$ Thermal Impedance                  | $45^\circ\text{C/W}$  |
| Lead Temperature                                 | JEDEC industry standard   |
| Soldering  | J-STD-020   |
| ESD (Human Body Model)                           | 1.5 kV  |

Stresses at or above those listed under Absolute Maximum Ratings may cause permanent damage to the product. This is a stress rating only; functional operation of the product at these or any other conditions above those indicated in the operational section of this specification is not implied. Operation beyond the maximum operating conditions for extended periods may affect product reliability.

This device is a high performance integrated circuit with an ESD rating of 1.5 kV, and it is ESD sensitive. Proper precautions should be taken for handling and assembly.

### ESD CAUTION



**ESD (electrostatic discharge) sensitive device.** Charged devices and circuit boards can discharge without detection. Although this product features patented or proprietary protection circuitry, damage may occur on devices subjected to high energy ESD. Therefore, proper ESD precautions should be taken to avoid performance degradation or loss of functionality.

## PIN CONFIGURATION AND FUNCTION DESCRIPTION

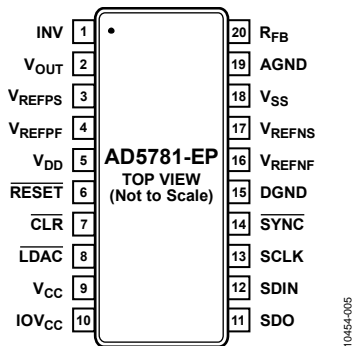

Figure 4. Pin Configuration

Table 5. Pin Function Descriptions

| Pin No. | Mnemonic           | Description  |
|---------|--------------------|--|
| 1       | INV                | Connection to Inverting Input of External Amplifier.   |
| 2       | V <sub>OUT</sub>   | Analog Output Voltage.   |
| 3       | V <sub>REFPS</sub> | Positive Reference Sense Voltage Input. A voltage range of 5 V to V <sub>DD</sub> – 2.5 V can be connected. A unity gain amplifier must be connected at this pin, in conjunction with the V <sub>REFPF</sub> pin.  |
| 4       | V <sub>REFPF</sub> | Positive Reference Force Voltage Input. A voltage range of 5 V to V <sub>DD</sub> – 2.5 V can be connected. A unity gain amplifier must be connected at these pin, in conjunction with the V <sub>REFPS</sub> pin.   |
| 5       | V <sub>DD</sub>    | Positive Analog Supply Connection. A voltage range of 7.5 V to 16.5 V can be connected. V <sub>DD</sub> should be decoupled to AGND.   |
| 6       | RESET              | Active Low Reset Logic Input Pin. Asserting this pin returns the AD5781-EP to its power-on status.   |
| 7       | CLR                | Active Low Clear Logic Input Pin. Asserting this pin sets the DAC register to a user defined value and updates the DAC output. The output value depends on the DAC register coding that is being used, either binary or twos complement.   |
| 8       | LDAC               | Active Low Load DAC Logic Input Pin. This is used to update the DAC register and, consequently, the analog output. When tied permanently low, the output is updated on the rising edge of SYNC. If LDAC is held high during the write cycle, the input register is updated, but the output update is held off until the falling edge of LDAC. The LDAC pin should not be left unconnected. |
| 9       | V <sub>CC</sub>    | Digital Supply Connection. A voltage in the range of 2.7 V to 5.5 V can be connected. V <sub>CC</sub> should be decoupled to DGND.   |
| 10      | IOV <sub>CC</sub>  | Digital Interface Supply Pin. Digital threshold levels are referenced to the voltage applied to this pin. A voltage range of 1.71 V to 5.5 V can be connected. IOV <sub>CC</sub> should not be allowed to exceed V <sub>CC</sub> .   |
| 11      | SDO                | Serial Data Output Pin. Data is clocked out on the rising edge of the serial clock input.  |
| 12      | SDIN               | Serial Data Input Pin. This device has a 24-bit shift register. Data is clocked into the register on the falling edge of the serial clock input.   |
| 13      | SCLK               | Serial Clock Input. Data is clocked into the input shift register on the falling edge of the serial clock input. Data can be transferred at clock rates of up to 35 MHz.   |
| 14      | SYNC               | Active Low Digital Interface Synchronization Input Pin. This is the frame synchronization signal for the input data. When SYNC is low, it enables the input shift register, and data is then transferred in on the falling edges of the following clocks. The input shift register is updated on the rising edge of SYNC.  |
| 15      | DGND               | Ground Reference Pin for Digital Circuitry.  |
| 16      | V <sub>REFNF</sub> | Negative Reference Force Voltage Input. A voltage range of V <sub>SS</sub> + 2.5 V to 0 V can be connected. A unity gain amplifier must be connected at this pin, in conjunction with the V <sub>REFNS</sub> pin.  |
| 17      | V <sub>REFNS</sub> | Negative Reference Sense Voltage Input. A voltage range of V <sub>SS</sub> + 2.5 V to 0 V can be connected. A unity gain amplifier must be connected at these pin, in conjunction with the V <sub>REFNF</sub> pin.   |
| 18      | V <sub>SS</sub>    | Negative Analog Supply Connection. A voltage range of –16.5 V to –2.5 V can be connected. V <sub>SS</sub> should be decoupled to AGND.   |
| 19      | AGND               | Ground Reference Pin for Analog Circuitry.   |
| 20      | R <sub>FB</sub>    | Feedback Connection for External Amplifier.  |



# TYPICAL PERFORMANCE CHARACTERISTICS

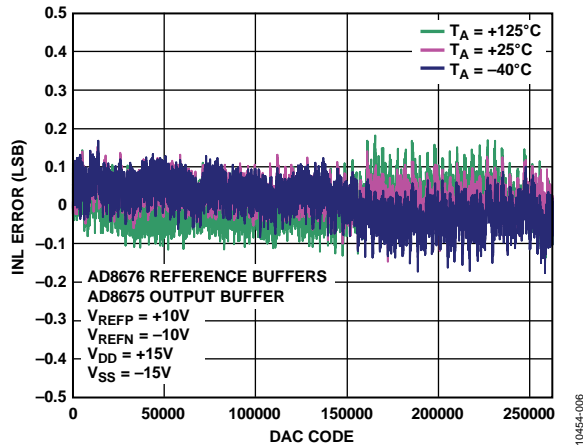

Figure 5. Integral Nonlinearity Error vs. DAC Code, ±10 V Span

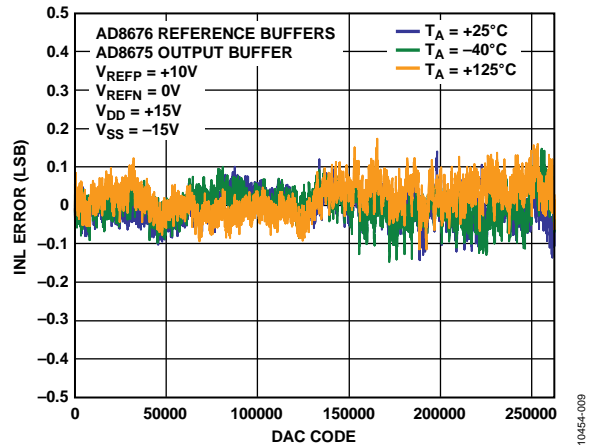

Figure 8. Integral Nonlinearity Error vs. DAC Code, ±10 V Span, ×2 Gain Mode

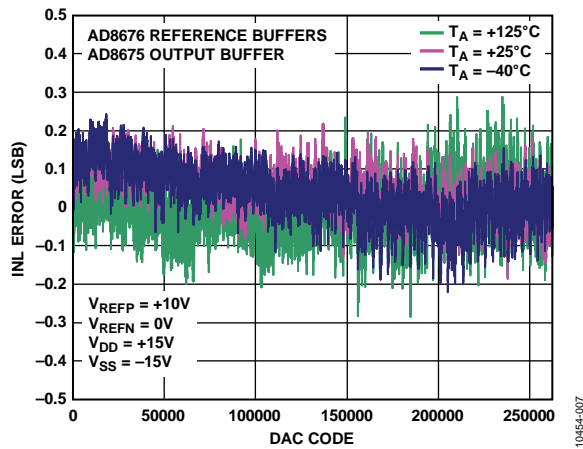

Figure 6. Integral Nonlinearity Error vs. DAC Code, +10 V Span

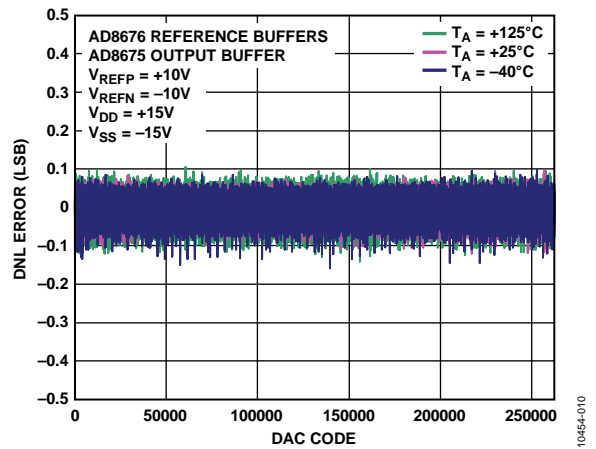

Figure 9. Differential Nonlinearity Error vs. DAC Code, ±10 V Span

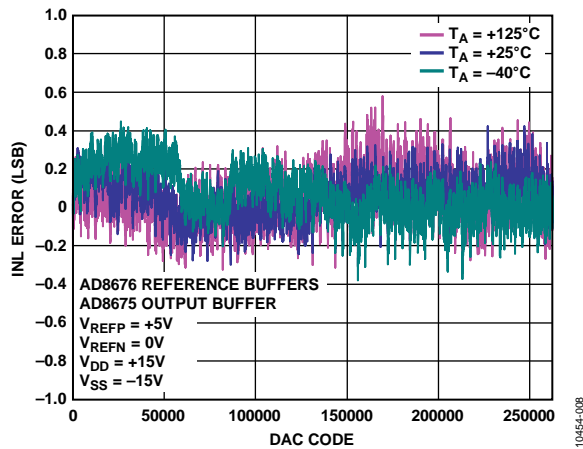

Figure 7. Integral Nonlinearity Error vs. DAC Code, +5 V Span

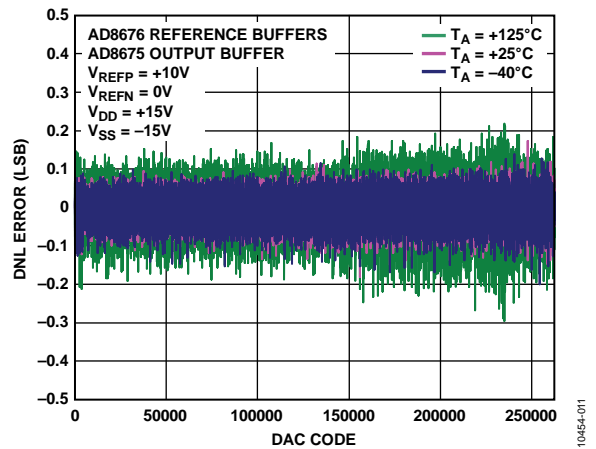

Figure 10. Differential Nonlinearity Error vs. DAC Code, +10 V Span

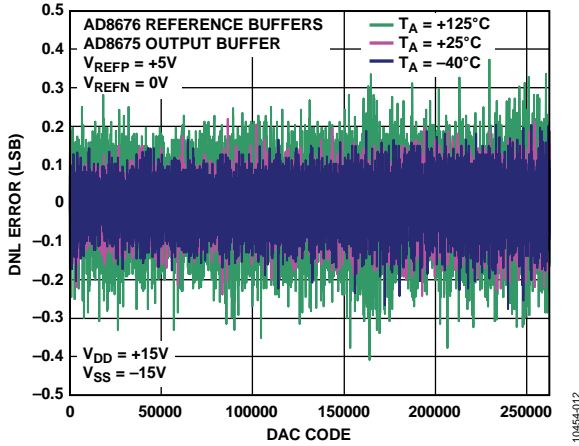

Figure 11. Differential Nonlinearity Error vs. DAC Code, +5 V Span

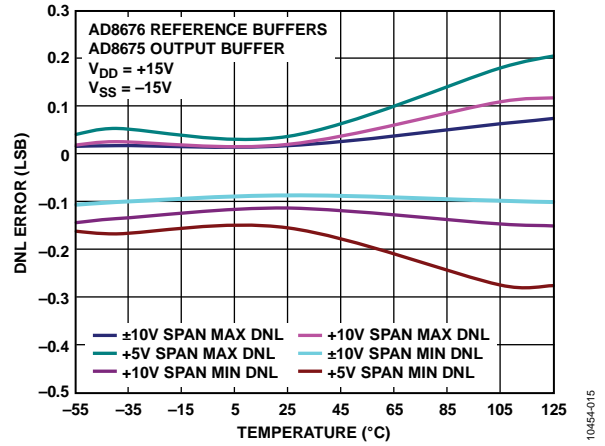

Figure 14. Differential Nonlinearity Error vs. Temperature

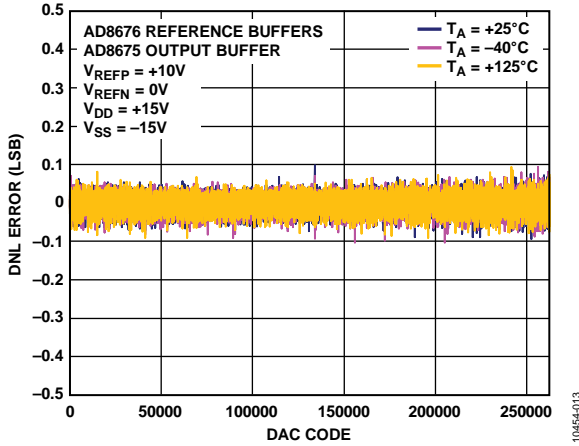

Figure 12. Differential Nonlinearity Error vs. DAC Code, ±10 V Span, ×2 Gain Mode

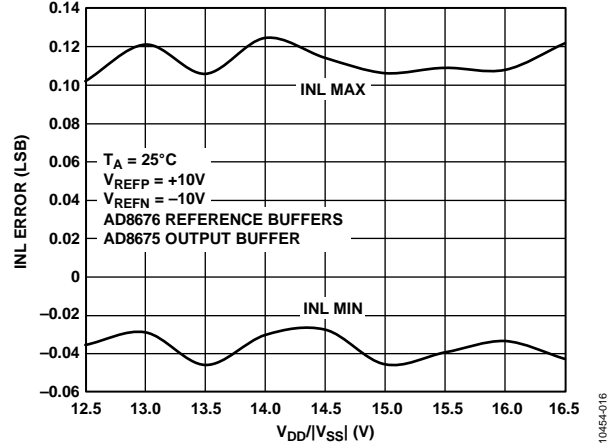

Figure 15. Integral Nonlinearity Error vs. Supply Voltage, ±10 V Span

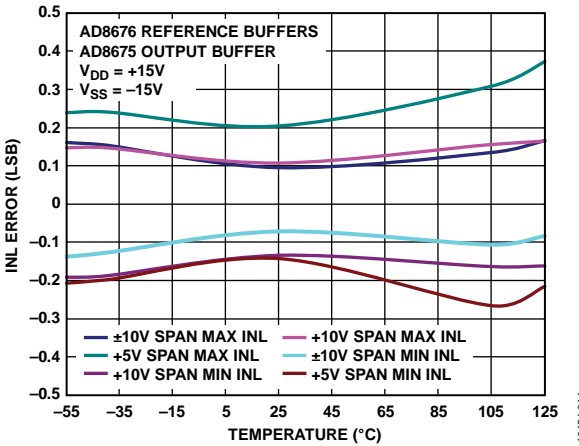

Figure 13. Integral Nonlinearity Error vs. Temperature

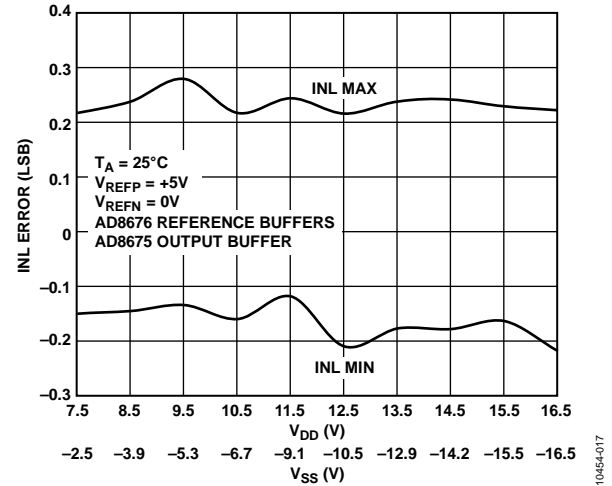
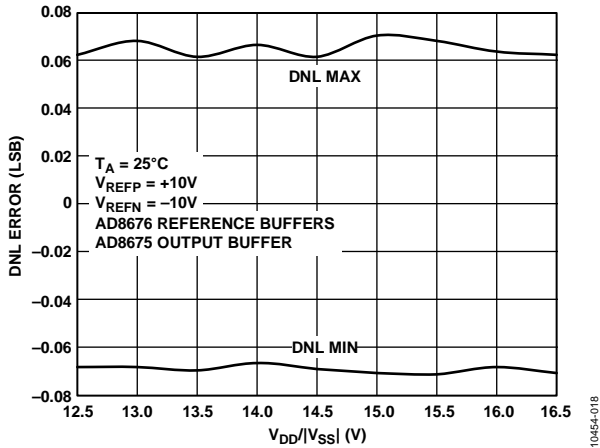
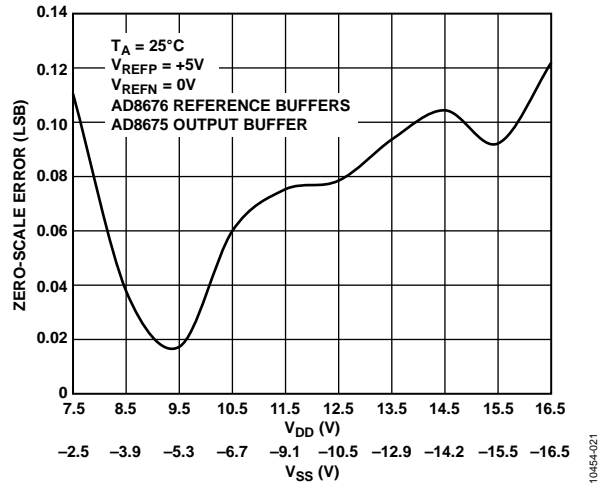

Figure 16. Integral Nonlinearity Error vs. Supply Voltage, +5 V Span



10454-018

Figure 17. Differential Nonlinearity Error vs. Supply Voltage, ±10 V Span



10454-021

Figure 20. Zero-Scale Error vs. Supply Voltage, +5 V Span

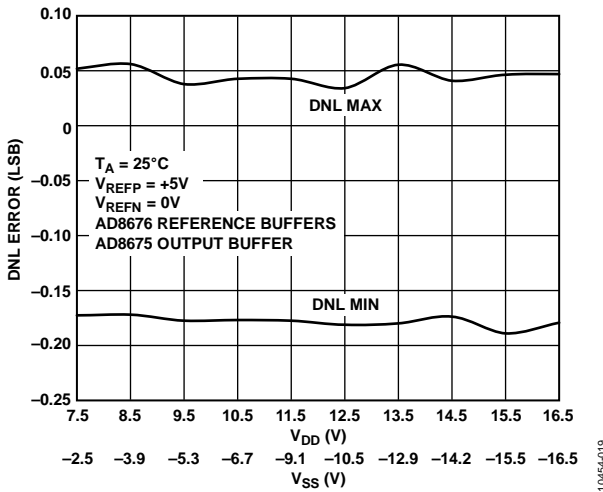

10454-019

Figure 18. Differential Nonlinearity Error vs. Supply Voltage, +5 V Span

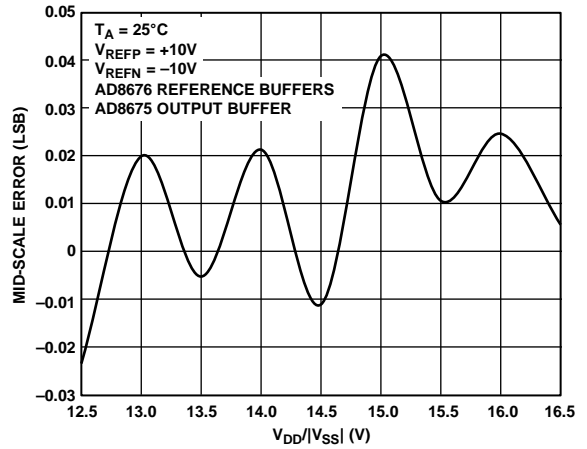

10454-022

Figure 21. Midscale Error vs. Supply Voltage, ±10 V Span

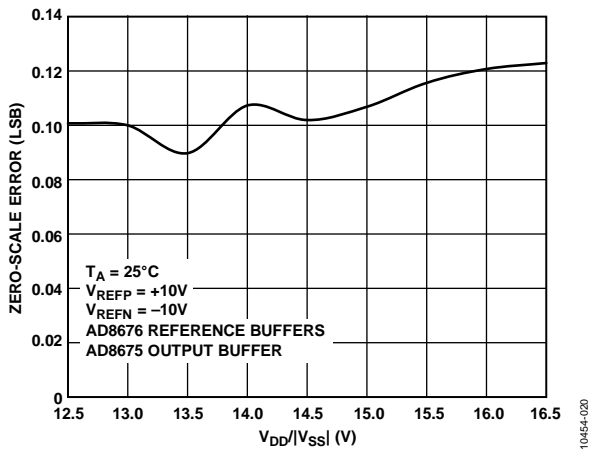

10454-020

Figure 19. Zero-Scale Error vs. Supply Voltage, ±10 V Span

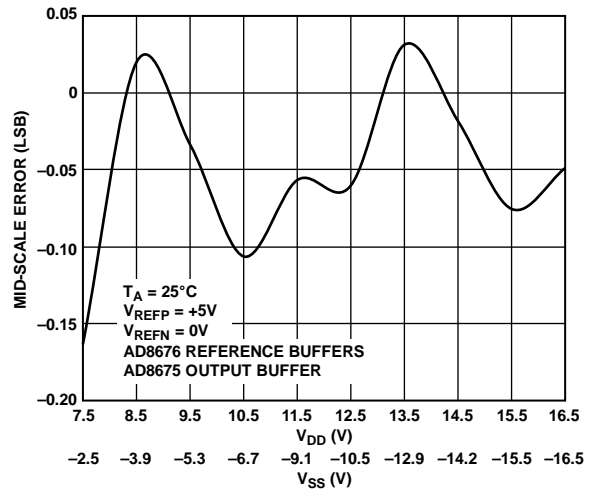

10454-023

Figure 22. Midscale Error vs. Supply Voltage, +5 V Span

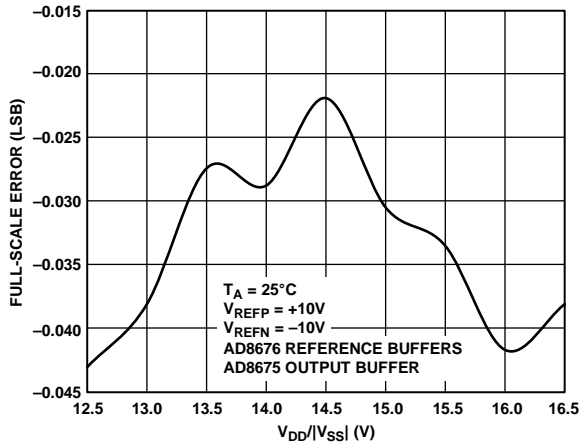

Figure 23. Full-Scale Error vs. Supply Voltage, ±10 V Span

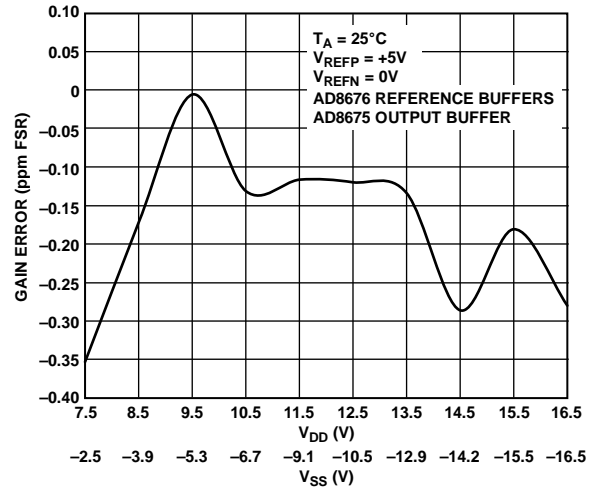

Figure 26. Gain Error vs. Supply Voltage, +5 V Span

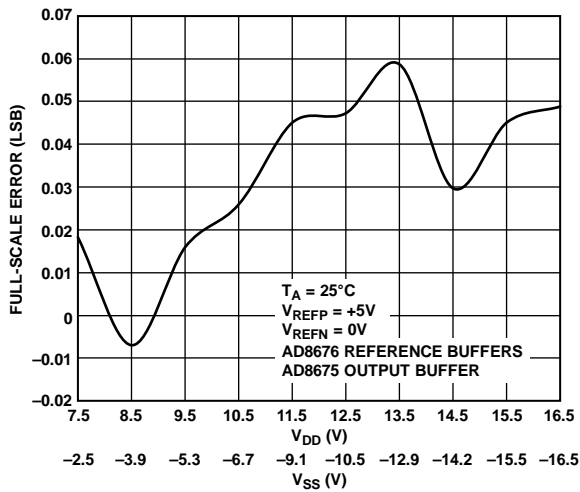

Figure 24. Full-Scale Error vs. Supply Voltage, +5 V Span

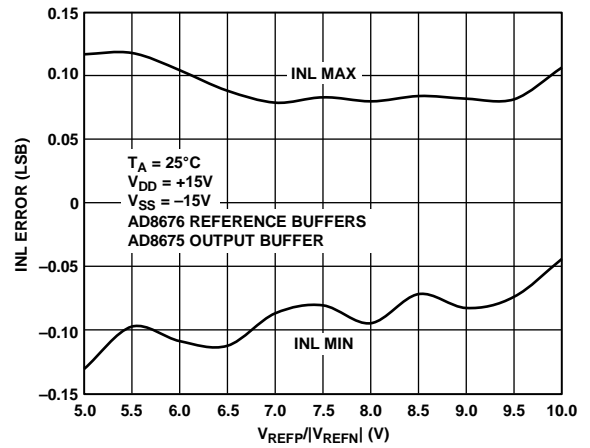

Figure 27. Integral Nonlinearity Error vs. Reference Voltage

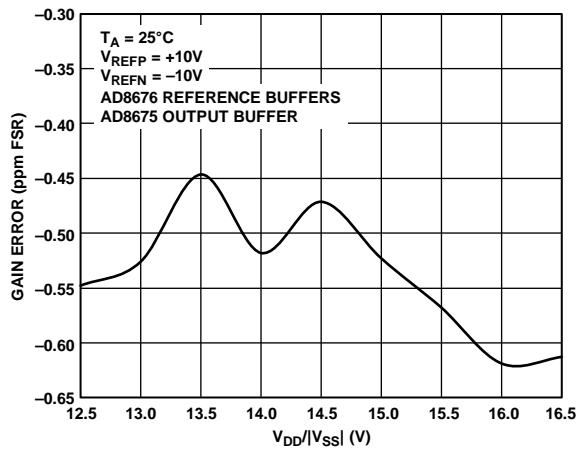

Figure 25. Gain Error vs. Supply Voltage, ±10 V Span

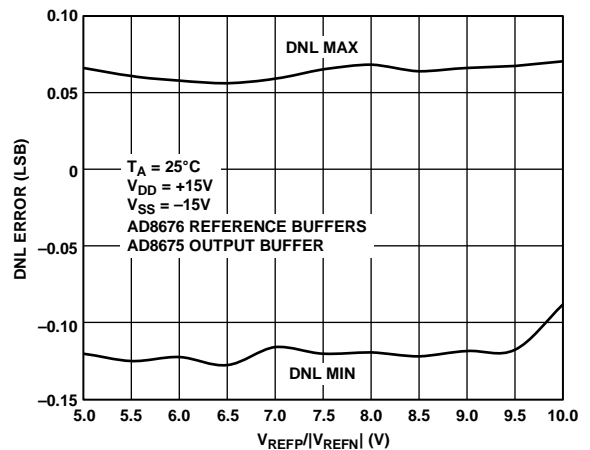

Figure 28. Differential Nonlinearity Error vs. Reference Voltage

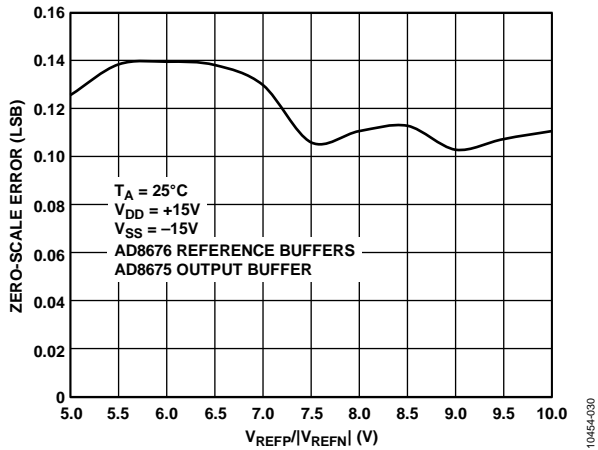

Figure 29. Zero-Scale Error vs. Reference Voltage

10454-030

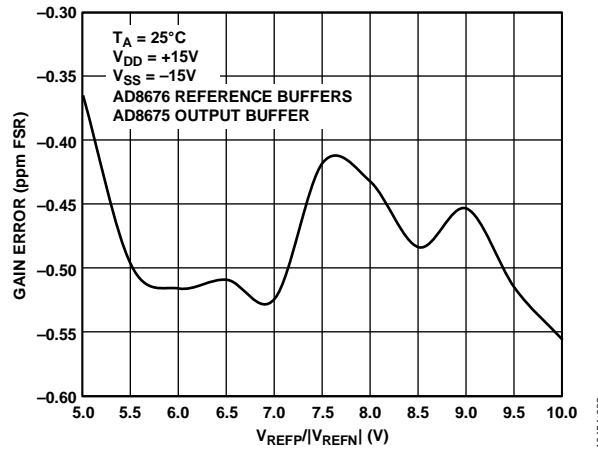

Figure 32. Gain Error vs. Reference Voltage

10454-033

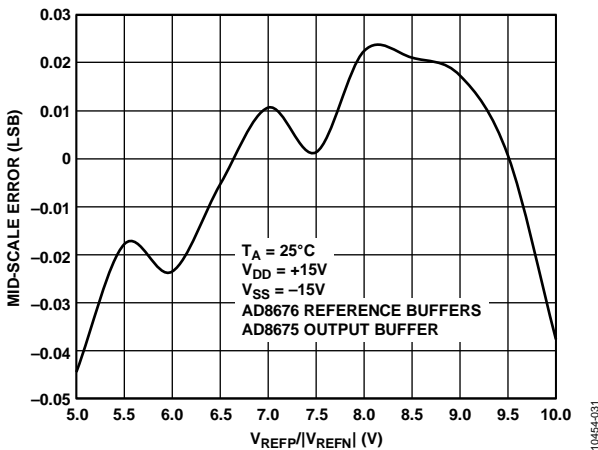

Figure 30. Mid-Scale Error vs. Reference Voltage

10454-031

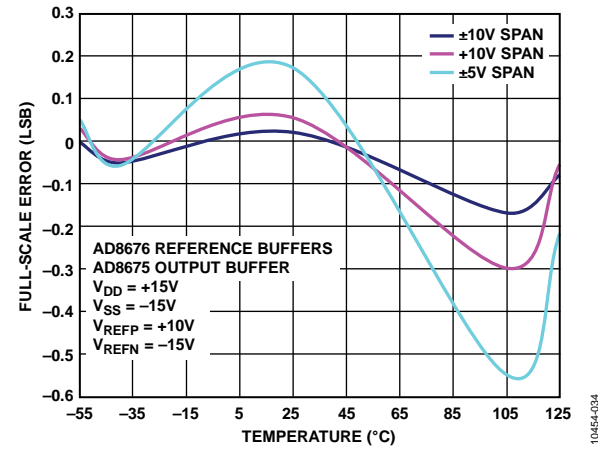

Figure 33. Full-Scale Error vs. Temperature

10454-034

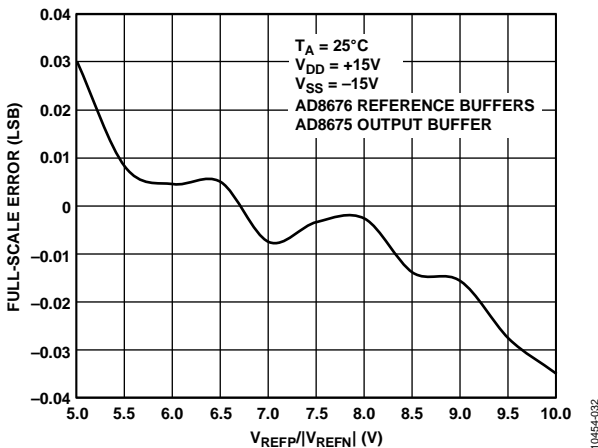

Figure 31. Full-Scale Error vs. Reference Voltage

10454-032

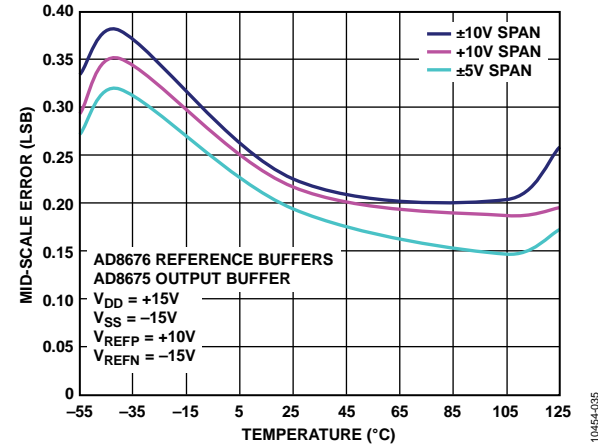

Figure 34. Mid-Scale Error vs. Temperature

10454-035

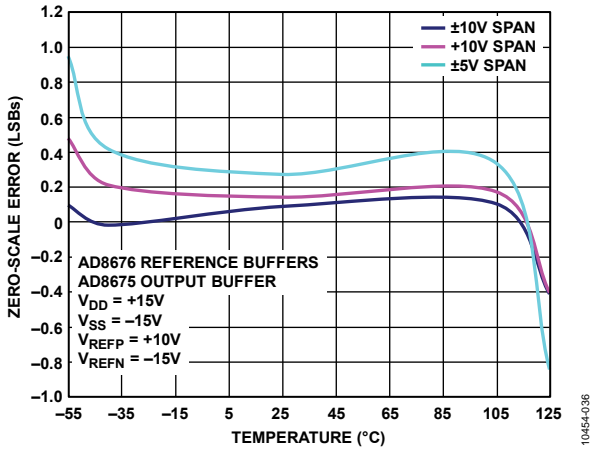

Figure 35. Zero-Scale Error vs. Temperature

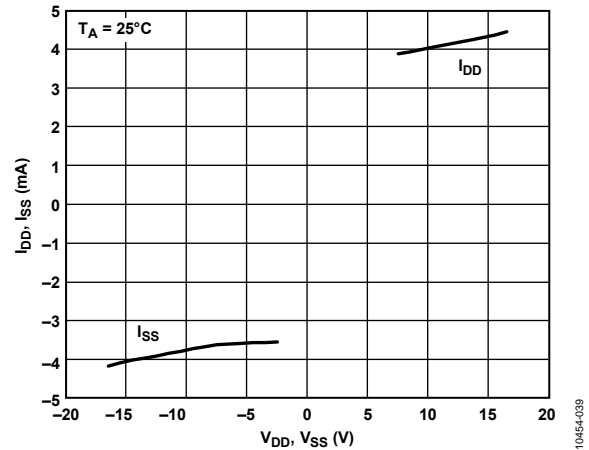

Figure 38. Power Supply Currents vs. Power Supply Voltages

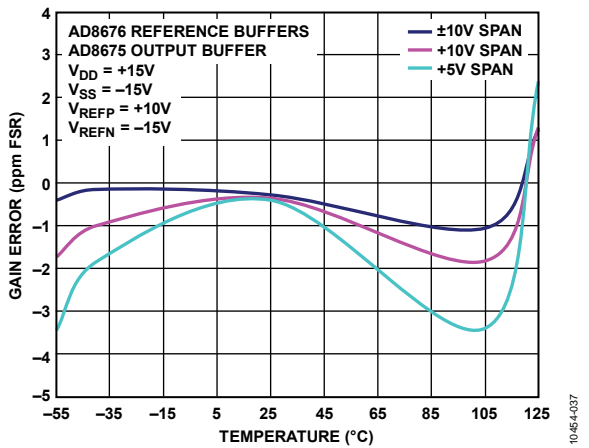

Figure 36. Gain Error vs. Temperature

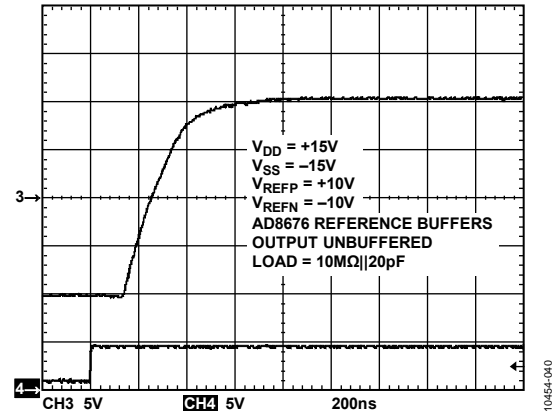

Figure 39. Rising Full-Scale Voltage Step

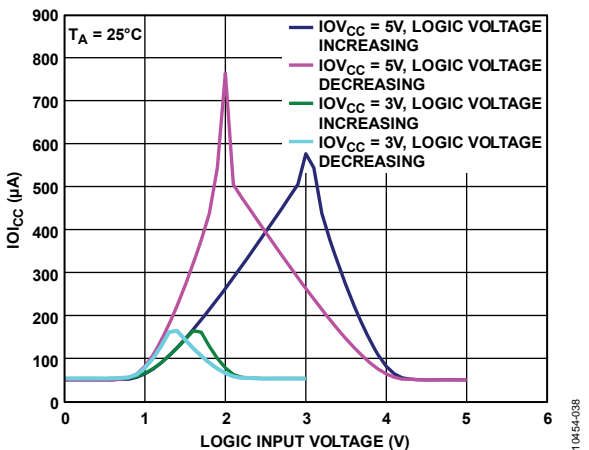

Figure 37.  $I_{OCC}$  vs. Logic Input Voltage

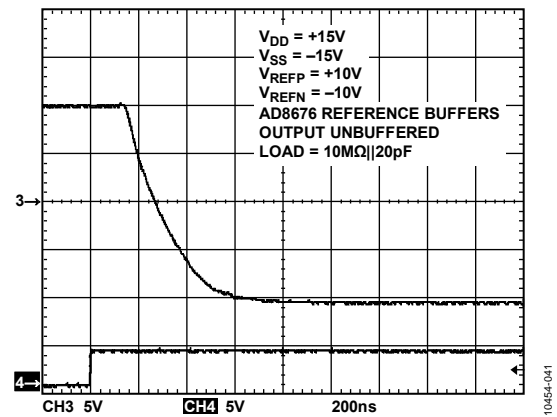

Figure 40. Falling Full-Scale Voltage Step

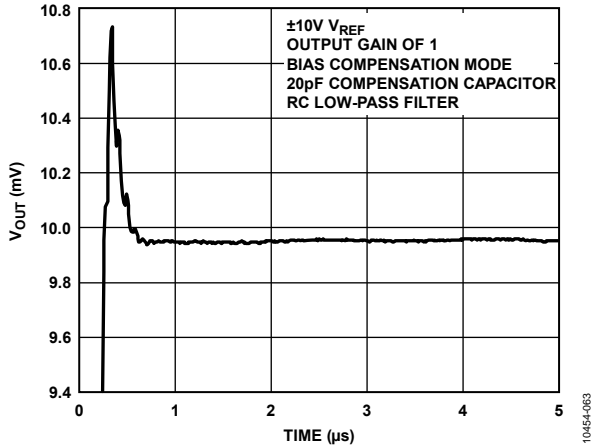

Figure 41. 125 Code Step Settling Time

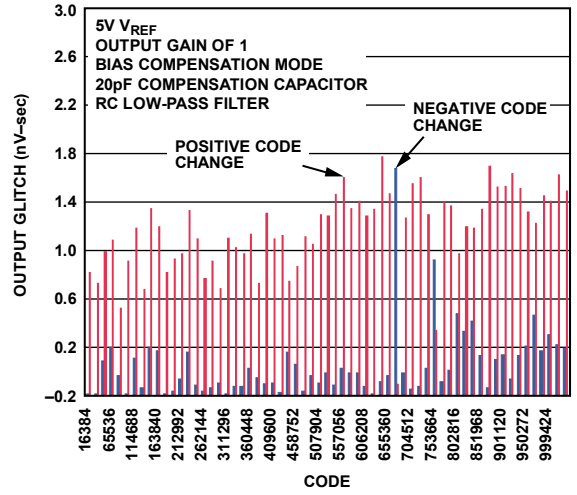

Figure 44. 6 MSB Segment Glitch Energy for 5 V<sub>REF</sub>

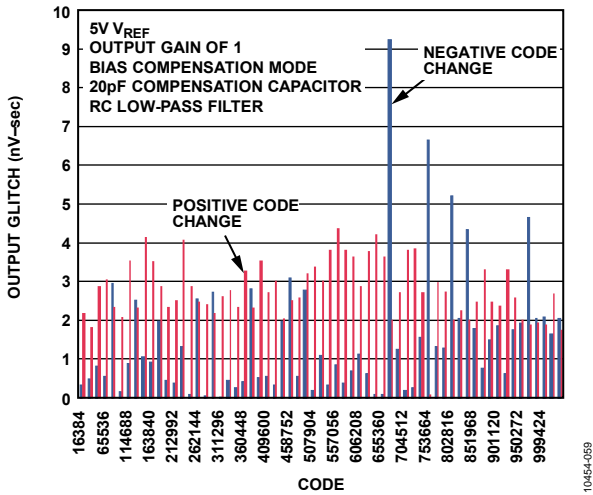

Figure 42. 6 MSB Segment Glitch Energy for ±10 V<sub>REF</sub>

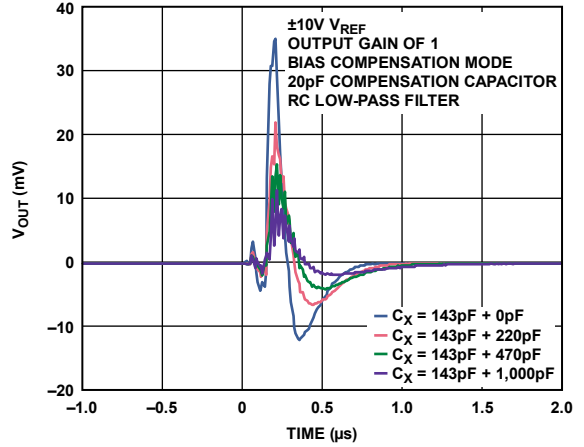

Figure 45. Midscale Peak-to-Peak Glitch for ±10 V

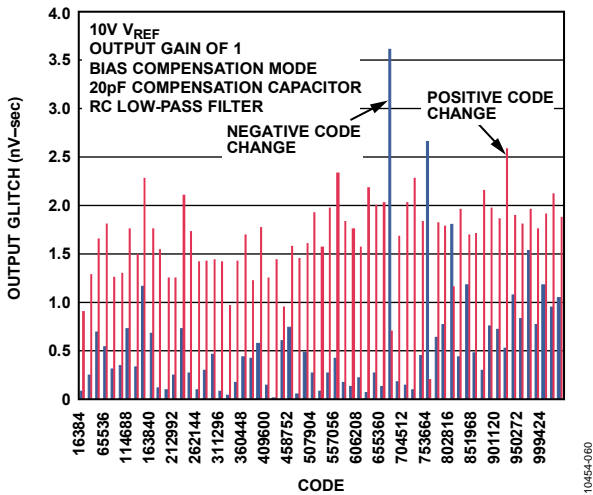

Figure 43. 6 MSB Segment Glitch Energy for 10 V<sub>REF</sub>

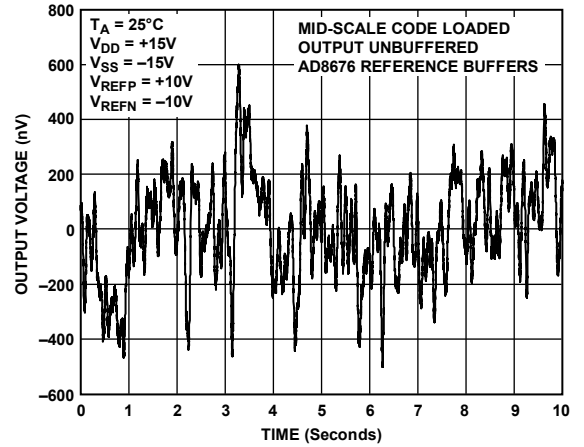

Figure 46. Voltage Output Noise, 0.1 Hz to 10 Hz Bandwidth

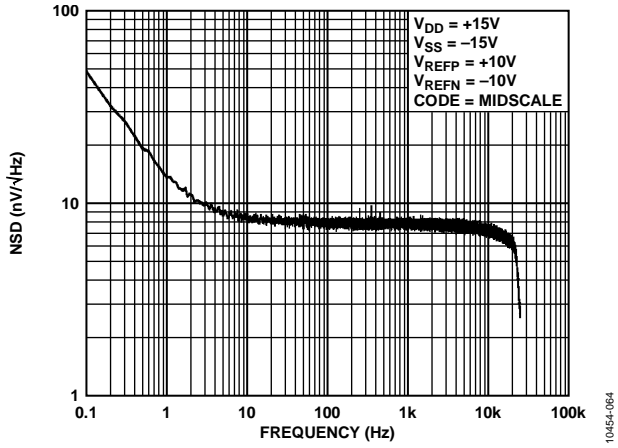

Figure 47. Noise Spectral Density vs. Frequency

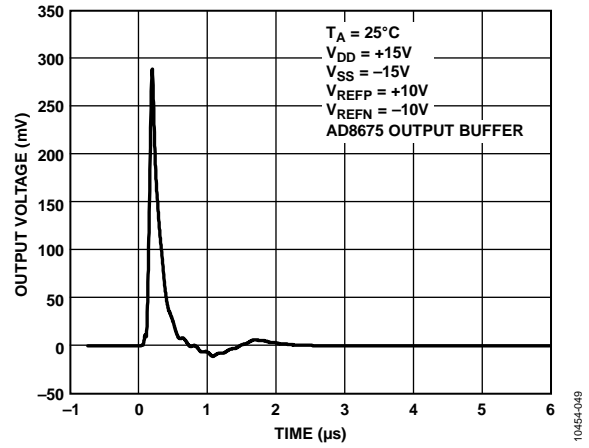
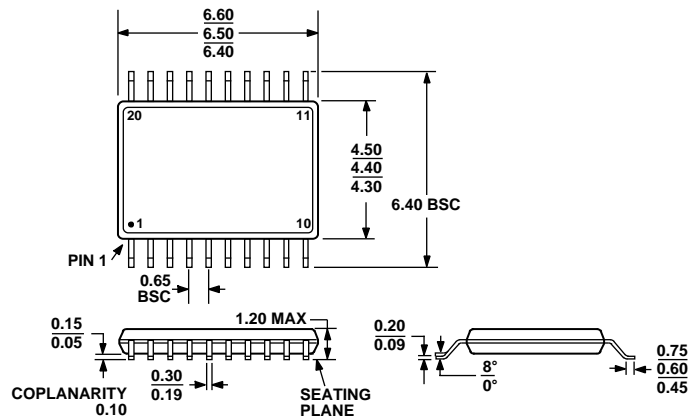

Figure 48. Glitch Impulse on Removal of Output Clamp



### OUTLINE DIMENSIONS



COMPLIANT TO JEDEC STANDARDS MO-153-AC

Figure 49. 20-Lead Thin Shrink Small Outline Package [TSSOP] (RU-20)

Dimensions shown in millimeters

### ORDERING GUIDE

| Model <sup>1</sup> | Temperature Range | INL      | Package Description | Package Option |
|--------------------|-------------------|----------|---------------------|----------------|
| AD5781SRU-EP       | -55°C to +125°C   | ±0.5 LSB | 20-Lead TSSOP       | RU-20          |
| AD5781SRUZ-EP      | -55°C to +125°C   | ±0.5 LSB | 20-Lead TSSOP       | RU-20          |

<sup>1</sup> Z = RoHS Compliant Part