

## Item description

### Female connector/socket *WINSTA*® MIDI rated current 25 A

For power and signal transmission: The *WINSTA*® MIDI female connector/socket 2-pole. WAGO pluggable installation connectors are useful when criteria repeat or are distributed on a specific grid, for example for installing grid lighting or flush-mount lighting. The color coding and mechanical coding of the pluggable installation connector ensure error-free installation of the individual components – including protection against mismatching. The pluggable installation connector offers protection against contact with live components in accordance with protection type IP20 (When mated and secured with a strain relief housing: IP2xC (These compact connectors are not designed for use in open, easily accessible areas!)). Coding in blue is used to identify *WINSTA*® MIDI pluggable installation connectors, which are used predominantly in automation of buildings for activating lighting. This pluggable installation connector can be used for electrical currents up to 25 A. Thus the product is ideally suitable for high power loads. The *WINSTA*® MIDI Pluggable Connection System with Push-in CAGE CLAMP® spring pressure connection technology facilitates precise electrification. Thanks to the built-in test slot, it is possible to check connections even when they are plugged in. This saves time, labor, and money.

### Lower costs through fast commissioning and elimination of service expenses – solutions from *WINSTA*® MIDI

*WINSTA*® is the pluggable connection system that is perfectly tailored to the strict requirements of electrical installation. It offers error-free

Subject to changes. Please also observe the further product documentation!



installation of cables and components, quickly and reliably. Now you can also reduce installation expenses without compromising quality and safety: The WINSTA® MIDI pluggable installation connector with marking reduces the need for servicing and prevents unnecessary downtime.

- pluggable installation connectors with protection against mismatching
- for automation controllers
- with I coding for controlling light (DALI standard)
- custom-engineered solutions
- rapid, structured electrical installation

## Data

### Electrical data

#### Ratings per IEC/EN

Ratings per	IEC/EN 60664-1
Nominal voltage (III/3)	250 V
Rated impulse voltage (III/3)	4 kV
Rated current	25 A
Legend (ratings)	(III / 3) ≙ Overvoltage category III / Pollution degree 3

#### Ratings per UL 1977

Note for the US market	Some versions may also be used for current interruption in accordance with the UL certificate in select applications with currents below 16 A and voltages up to 600 V. For further information, please contact your local sales office.
Rated voltage (UL 1977)	600 V
Rated current UL 1977	23 A

### General

Note on contact resistance	approx. 1 mΩ of contact resistance approx. 0.25 mΩ contact transition plug/socket
----------------------------	--

### Connection data

Connection points	4
Total number of potentials	2

Subject to changes. Please also observe the further product documentation!



## Connection 1

Connection technology	Push-in CAGE CLAMP®
Actuation type	Operating tool Push-in
Nominal cross-section	4 mm <sup>2</sup> / 12 AWG
Solid conductor	0.5 ... 4 mm <sup>2</sup> / 20 ... 12 AWG
Solid conductor; push-in termination	1.5 ... 4 mm <sup>2</sup> / 16 ... 12 AWG
Stranded conductor	0.5 ... 2.5 mm <sup>2</sup> / 20 ... 14 AWG
Fine-stranded conductor	0.5 ... 4 mm <sup>2</sup> / 20 ... 12 AWG
Fine-stranded conductor; with insulated ferrule	0.25 ... 1.5 mm <sup>2</sup> / 20 ... 16 AWG
Fine-stranded conductor; with uninsulated ferrule	0.25 ... 2.5 mm <sup>2</sup> / 20 ... 14 AWG
Fine-stranded conductor; with ferrule; push-in termination	1.5 mm <sup>2</sup> / 16 AWG
Strip length	9 mm / 0.35 inches
Pole number	2
Conductor entry direction to mating direction	0°

## Physical data

Pin spacing	10 mm / 0.394 inches
Width	20 mm / 0.787 inches
Height	12.9 mm / 0.508 inches
Depth	37.5 mm / 1.476 inches

## Mechanical Data

Application	DALI, Lighting Management
Coding	I
Variable coding	No
Marking	DA+ DA-
Potential marking	DA+ DA-
Mating force of a plug-in connection	approx. 20 ... 70 N (depending on pole number)
Retention force of a plug-in connection	Locked: > 80 N
Unmating force of a plug-in connection	Unlocked: approx. 20 ... 70 N (depending on pole number)
Number of mating cycles	200, without resistive load
Protection type	IP20; When mated and secured with a strain relief housing: IP2xC (These compact connectors are not designed for use in open, easily accessible areas!)

Subject to changes. Please also observe the further product documentation!



## Plug-in connection

Contact type (pluggable connector)	Female connector/socket
Connector (connection type)	for conductor
Mismating protection	Yes
Note on mismating protection	All <i>WINSTA</i> <sup>®</sup> components are 100% protected against mismating when: a.) plugging different numbers of poles b.) plugging while rotated 180 c.) plugging while laterally staggered d.) plugging one pole
Locking lever	Can be retrofitted
Locking of plug-in connection	locking lever
Note on locking system	All connectors for mounted installations (snap-in versions for lighting fixtures or devices, all types of PCB and distribution connectors) are factory-equipped with locking levers to ensure plugs and sockets are securely locked. Additional locking levers are only required for flying leads (plug/socket).

## Material Data

Note (material data)	Information on material specifications can be found here
Color	blue
Cover color	gray
Material group	I
Insulation material	Polyamide (PA66)
Flammability class per UL94	V0
Clamping spring material	Chrome-nickel spring steel (CrNi)
Contact material	Copper or copper alloy; surface-treated
Contact plating	Tin
Fire load	0.127 MJ
Weight	6.6 g

## Environmental requirements

Processing temperature	-5 ... +40 °C
Continuous operating temperature	-35 ... +85 °C
Note on continuous operating temperature	Insulating parts for temperatures ≤ 105 °C

Subject to changes. Please also observe the further product documentation!

WAGO GmbH & Co. KG  
Hansastr. 27  
32423 Minden  
Phone: +49571 887-0 | Fax: +49571 887-169  
Email: [info.de@wago.com](mailto:info.de@wago.com) | Web: [www.wago.com](http://www.wago.com)

Do you have any questions about our products?  
We are always happy to take your call at +49 (571) 887-44222.

## Commercial data



Product Group	20 (Winsta)
eCl@ss 10.0	27-44-06-05
eCl@ss 9.0	27-44-06-05
ETIM 8.0	EC002560
ETIM 7.0	EC002560
PU (SPU)	100 pcs
Packaging type	box
Country of origin	DE
GTIN	4050821028154
Customs tariff number	85366990990

## Environmental Product Compliance

RoHS Compliance Status	Compliant, No Exemption
------------------------	-------------------------

## Approvals / Certificates

### General approvals

Logo	Approval	Additional Approval Text	Certificate name
	CCA DEKRA Certification B.V.	EN 61535	71-123228
	CCA DEKRA Certification B.V.	IEC 61535	NL -84761
	cURus Underwriters Laboratories Inc.	UL 1977	E45171
	VDE VDE Prüf- und Zertifizierungsinstitut	EN 61535	40029808



## Declarations of conformity and manufacturer's declarations

Logo	Approval	Additional Approval Text	Certificate name
	EU-Declaration of Conformity WAGO GmbH & Co. KG	-	-





Subject to changes. Please also observe the further product documentation!



### Approvals for marine applications

Logo	Approval	Additional Approval Text	Certificate name
	<b>ABS</b> American Bureau of Shipping	-	19- HG1868589- PDA
	<b>DNV GL</b> Det Norske Veritas, Germanischer Lloyd	-	TAE00001Z6
	<b>LR</b> Lloyds Register	IEC 61984	LR22429487TA

### Counterpart

	<b>Item no.770-7102</b> Linect® T-connector; 2-pole; Cod. I; 1 input; 2 outputs; white	<a href="http://www.wago.com/770-7102">www.wago.com/770-7102</a>
	<b>Item no.770-1112</b> Plug; 2-pole; Cod. I; 4,00 mm <sup>2</sup> ; blue	<a href="http://www.wago.com/770-1112">www.wago.com/770-1112</a>
	<b>Item no.771-8982/006-101</b> pre-assembled interconnecting cable; Eca; Socket/plug; 2-pole; Cod. I; H05VV-F 2 x 1.5 mm <sup>2</sup> ; 1 m; 1,50 mm <sup>2</sup> ; blue	<a href="http://www.wago.com/771-8982/006-101">www.wago.com/771-8982/006-101</a>
	<b>Item no.771-8982/206-101</b> pre-assembled connecting cable; Eca; Plug/open-ended; 2-pole; Cod. I; H05VV-F 2 x 1.5 mm <sup>2</sup> ; 1 m; 1,50 mm <sup>2</sup> ; blue	<a href="http://www.wago.com/771-8982/206-101">www.wago.com/771-8982/206-101</a>

### Required accessories

#### Strain relief

	Strain relief housing	
	<b>Item no.: 770-502/041-000</b> Strain relief housing; 2-pole; with locking clip; for 1 cable; 7.0 ... 10.5 mm; 35 mm; black	<a href="http://www.wago.com/770-502/041-000">www.wago.com/770-502/041-000</a>

Subject to changes. Please also observe the further product documentation!



Item no.: 770-502/042-000

Strain relief housing; 2-pole; with locking clip; for 1 cable; 5.0 ... 9.0 mm; 35 mm; black

[www.wago.com/770-502/042-000](http://www.wago.com/770-502/042-000)



Item no.: 770-512/041-000

Strain relief housing; 2-pole; with locking clip; for 1 cable; 7.0 ... 10.5 mm; 35 mm; white

[www.wago.com/770-512/041-000](http://www.wago.com/770-512/041-000)



Item no.: 770-512/042-000

Strain relief housing; 2-pole; with locking clip; for 1 cable; 5.0 ... 9.0 mm; 35 mm; white

[www.wago.com/770-512/042-000](http://www.wago.com/770-512/042-000)

## Locking levers

### Locking system



Item no.: 770-121

Locking lever; for flying leads; for manual operation; white

[www.wago.com/770-121](http://www.wago.com/770-121)



Item no.: 770-131

Locking lever; for flying leads; for tool operation; white

[www.wago.com/770-131](http://www.wago.com/770-131)



Item no.: 770-101

Locking lever; for flying leads; for manual operation; black

[www.wago.com/770-101](http://www.wago.com/770-101)



Item no.: 770-111

Locking lever; for flying leads; for tool operation; black

[www.wago.com/770-111](http://www.wago.com/770-111)

## Optional accessories

### Tool

#### Operating tool



Item no.: 210-719

Operating tool; Blade: 2.5 x 0.4 mm; with a partially insulated shaft

[www.wago.com/210-719](http://www.wago.com/210-719)



Item no.: 770-382

Operating tool; 2-way; green

[www.wago.com/770-382](http://www.wago.com/770-382)

### Mounting

#### Snap-in frame



Item no.: 770-317

Snap-in frame; 2-pole; 1.0 ... 3.0 mm; black

[www.wago.com/770-317](http://www.wago.com/770-317)

Subject to changes. Please also observe the further product documentation!

WAGO GmbH & Co. KG

Hansastr. 27

32423 Minden

Phone: +49571 887-0 | Fax: +49571 887-169

Email: [info.de@wago.com](mailto:info.de@wago.com) | Web: [www.wago.com](http://www.wago.com)

Do you have any questions about our products?

We are always happy to take your call at +49 (571) 887-44222.



**Item no.: 770-337**

Snap-in frame; 2-pole; 1.0 ... 3.0 mm; black

[www.wago.com/770-337](http://www.wago.com/770-337)

---

Mounting accessories

---



**Item no.: 897-2100**

Mounting plate; for Snap-in; Plastic; for detectors and sensors ; Ø 200 mm; red

[www.wago.com/897-2100](http://www.wago.com/897-2100)

---

Cover

Cover



**Item no.: 770-201**

Lockout cap; 12-pole, separable; for sockets; Plastic; black

[www.wago.com/770-201](http://www.wago.com/770-201)



**Item no.: 770-221**

Lockout cap; 12-pole, separable; for sockets; Plastic; white

[www.wago.com/770-221](http://www.wago.com/770-221)



**Item no.: 897-2003**

Protective cap; Type2; for sockets and plugs; PVC; red

[www.wago.com/897-2003](http://www.wago.com/897-2003)

---

**Downloads**

**Documentation**

**Bid Text**

770-1102 X81 - Datei	2019 Feb 19	xml 3.0 kB	Download
770-1102 doc - Datei	2015 Jun 8	doc 24.1 kB	Download

---

**CAD/CAE-Data**

**CAE data**

EPLAN Data Portal 770-1102	URL	Download
WSCAD Universe 770-1102	URL	Download

Subject to changes. Please also observe the further product documentation!



## Environmental Product Compliance

### Compliance Search

Environmental Product Compliance 770-1102

URL

Download

Socket; 2-pole; Cod. I; 4,00 mm<sup>2</sup>; blue

## Installation Notes

### Conductor termination

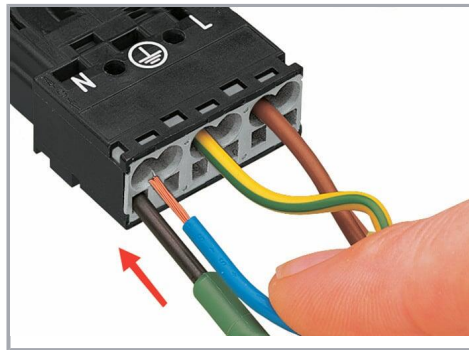
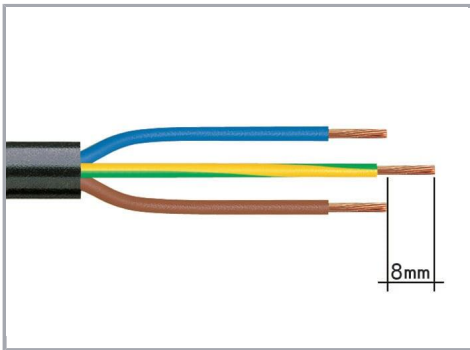

1. Strip length, outer insulation = 35 mm (2-pole), 55 mm (3- to 5-pole)

2. Strip length = 9 mm

3. Extended ground conductor = 8 mm

To terminate fine-stranded conductors, open the clamping unit via screwdriver (2.5 mm blade width) and insert a stripped conductor until it hits the backstop.

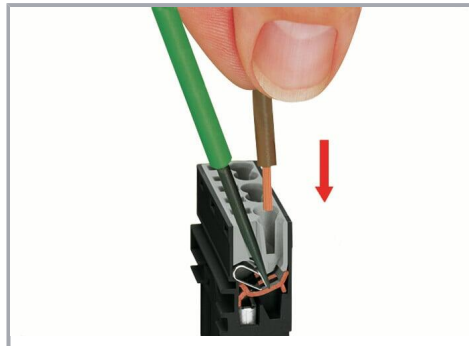
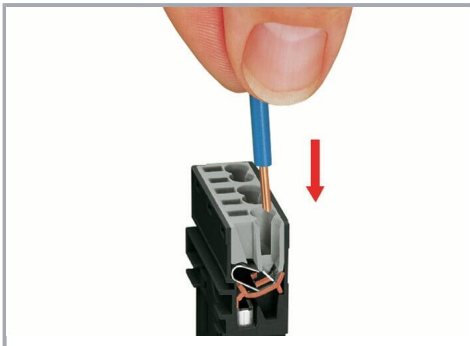

Insert the stripped solid conductor until it hits the backstop.

To terminate fine-stranded conductors, open the clamping unit via screwdriver (2.5 mm blade width) and insert a stripped conductor until it hits the backstop.

Subject to changes. Please also observe the further product documentation!

### Conductor removal

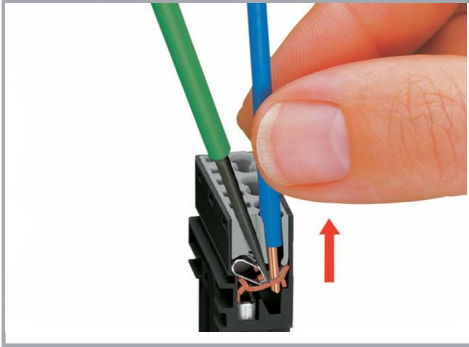

To remove the conductor, actuate the clamp via screwdriver (2.5 mm blade width) and pull out the conductor.

### Installation

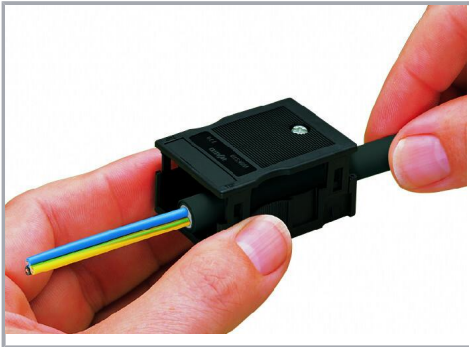

We recommend pulling the pre-latched strain relief housing over the cable prior to termination. However, the strain relief can be mounted at a later time as well.

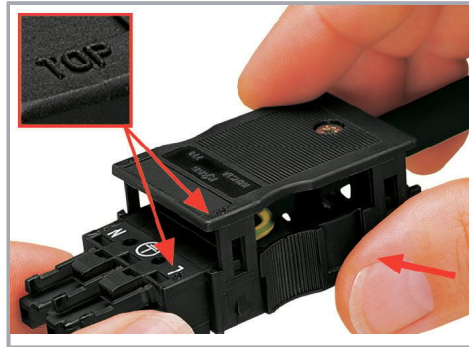

Latch the strain relief housing onto the plug /socket. Note the "TOP" inscription.

Subject to changes. Please also observe the further product documentation!

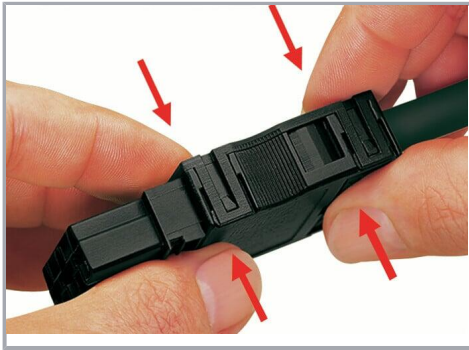

Prepare strain relief housing by snapping together upper and bottom part.



Tighten strain relief screw with screwdriver (2.5 mm blade width).

## Product family

**WINSTA® MIDI**

[Show all products from the family](#)

Subject to changes. Please also observe the further product documentation!