



Operating the THERMOMARK GO.K thermal transfer printer

User manual

User manual

Operating the THERMOMARK GO.K thermal transfer printer

UM EN THERMOMARK GO.K, Revision 00

2021-05-18

This user manual is valid for:

Designation	Version	Order No.
THERMOMARK GO.K		1184146
THERMOMARK GO.K SET		1184148

109432_en_00

Table of contents

1	For your safety	5
1.1	Identification of warning notes.....	5
1.2	Qualification of users	5
1.3	Field of application	5
1.4	Safety notes	6
2	Starting up the printer	7
2.1	Checking the scope of supply	7
2.2	Overview of the device.....	8
2.3	Connecting the power supply.....	9
2.4	Inserting the material cartridge.....	11
2.5	Switching on the device	11
3	Operating elements	12
3.1	Display.....	14
3.2	Menu.....	15
4	Creating the marking	23
4.1	Creating the marking on the display	23
4.2	Creating the marking on the PC	33
4.3	Printing.....	34
5	Maintenance and troubleshooting	35
5.1	Cleaning.....	35
5.2	Troubleshooting.....	37
5.3	Repairs	41
5.4	Firmware update.....	41
5.5	Disposal.....	41
6	Appendix	42
6.1	Technical data	42
6.2	Ordering data for accessories.....	43
6.3	Overview of the symbols.....	44
6.4	Approvals.....	47

1 For your safety

Read this user manual carefully and keep it for future reference.

1.1 Identification of warning notes



This symbol indicates hazards that could lead to personal injury. There are three signal words indicating the severity of a potential injury.

DANGER

Indicates a hazard with a high risk level. If this hazardous situation is not avoided, it will result in death or serious injury.

WARNING

Indicates a hazard with a medium risk level. If this hazardous situation is not avoided, it could result in death or serious injury.

CAUTION

Indicates a hazard with a low risk level. If this hazardous situation is not avoided, it could result in minor or moderate injury.



This symbol together with the **NOTE** signal word warns the reader of actions that might cause property damage or a malfunction.



Here you will find additional information or detailed sources of information.

1.2 Qualification of users

This user manual is aimed at those persons who are familiar with the relevant safety concepts for handling electrical machines. Only those persons who can identify hazards may start up, operate, and maintain the device.

1.3 Field of application

The THERMOMARK GO.K is a portable thermal transfer printer for industrial use. The thermal transfer printer prints self-adhesive and non-adhesive labels and shrink sleeves for marking electrical components.

The THERMOMARK GO.K uses special material cartridges that contain the material as well as the corresponding ink ribbon. Only use material cartridges that are provided for the THERMOMARK GO.K by Phoenix Contact.

1.4 Safety notes

Hazard to operational safety

Incorrect operation or modifications to the device can endanger your safety or damage the printer. Do not repair the device yourself. If the device is defective, please contact Phoenix Contact.

This device is not suitable for use at locations where children might be present.

Explosion hazard, fire hazard, and health hazard if batteries are used incorrectly

- Only use dry batteries in a proper condition. Only the associated battery is suitable for battery operation (THERMOFOX/ACCU, 0805009).
- Never damage the batteries (e.g., by throwing, pressing on the battery, or using sharp objects). Never expose the batteries to high levels of heat (e.g., caused by fire or sunlight). Never let the batteries come in contact with moisture or salt water.
- Pay attention to the correct polarity when inserting the batteries.
- Only charge the battery in the THERMOMARK GO.K or in the provided charger (THERMOFOX/CHARGER, 0805012). Do not use any other chargers, e.g., cigarette lighter socket in the car.
- Temperature range when charging the battery: 0°C ... 45°C
- Store the battery separately in a dry and cool place.
- Never expose batteries to an extremely low air pressure.

Damage to the device

- Do not operate the printer near high-voltage lines.
- Only operate the printer in a dry location protected from splash water.
- Protect the printer and printing materials from humidity, moisture, and dirt.
- Only connect the printer to systems that have a protective extra-low voltage.
- To operate the printer on the power grid, only use the supplied wide range power supply unit (THERMOFOX/ADAPTER, 0805010).

2 Starting up the printer

2.1 Checking the scope of supply

THERMOMARK GO.K

- Printer
- Brief instructions

THERMOMARK GO.K SET

- Printer
- Rechargeable battery (THERMOFOX/ACCU, 0805009)
- Wide range power supply unit with power cable and four adapters for different sockets (THERMOFOX/ADAPTER, 0805010)
- USB cable
- Two material cartridges
 - Vinyl polymer, 18 mm, white (MM-EMLF (EX18)R C1 WH/BK, 0803939)
 - Polyamide, 18 mm, white (MM-EMLC (EX18)R C1 WH/BK, 0803936)

Unpacking

- Check the printer for transport damage.

2.2 Overview of the device

Figure 2-1 Overview

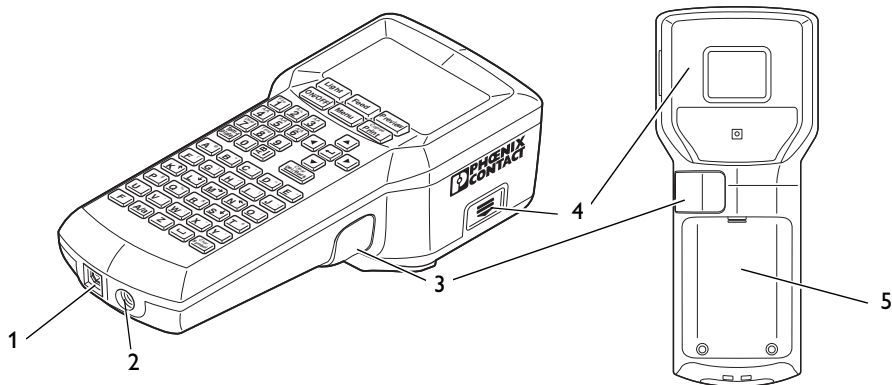

- 1 Socket for USB connection
- 2 Socket for power supply unit
- 3 Lever for cutting continuous material
- 4 Compartment for material cartridge
- 5 Battery compartment

2.3 Connecting the power supply

The THERMOMARK GO.K can be supplied with power in different ways.

- Batteries (6 x AA alkaline)
- AC wide range power supply unit (THERMOFOX/ADAPTER, 0805010)
- Battery (THERMOFOX/ACCU, 0805009)

If the THERMOMARK GO.K is connected to the power supply via the power supply unit, the battery in the THERMOMARK GO.K is automatically charged. The battery can also be charged using an external charger (THERMOFOX/CHARGER, 0805012).

Connecting the power supply unit

The THERMOMARK GO.K is designed for power grids from 100 to 240 V AC.

Only use the supplied wide range power supply unit (THERMOFOX/ADAPTER, 0805010).

Figure 2-2 Mains connection

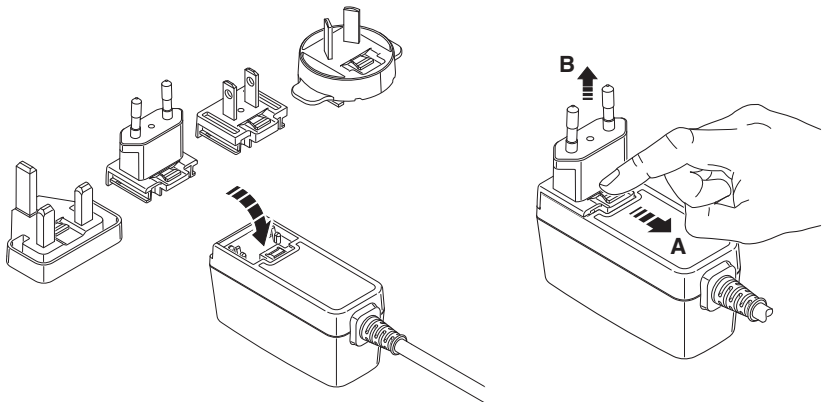

- Slightly tilt the relevant adapter and place it onto the front side of the power supply unit and press the adapter down. To remove the adapter, pull the slider on the base element in the direction of the cable.
- Plug the connecting cable of the power supply unit into the socket on the printer.
- Plug the power supply unit into the socket.

Inserting the battery

Figure 2-3 Opening the battery compartment

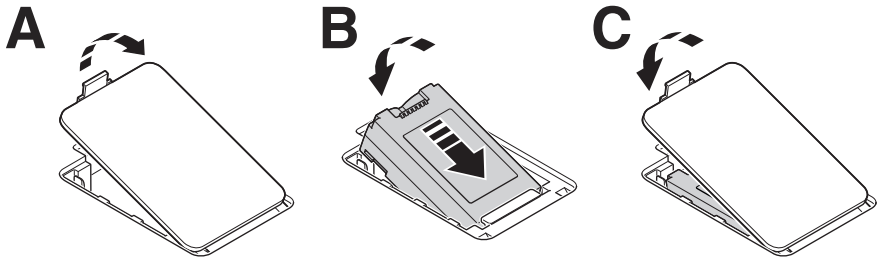

WARNING: Explosion hazard

Only use batteries of the stated type. Using incorrect types may disable protective measures.



WARNING: Risk of fire

Only operate the device if the battery cover is closed correctly. Combustible material close to the battery compartment may ignite.

- To open the battery compartment, push the interlock of the cover in the direction of the connections.
- Slightly tilting the battery, insert it into the battery compartment making sure of the correct polarity.
- Press down the battery.
- Close the cover.

2.4 Inserting the material cartridge

Figure 2-4 Replacing the material cartridge

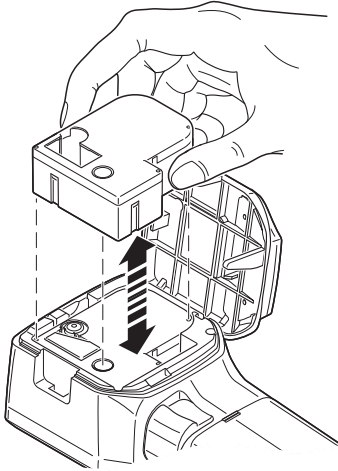

- Keeping the material cartridge straight, insert it into the compartment from above so that it engages with a click.
Make sure that the material end is in the output tray.
- To remove the material cartridge, pull it upward while keeping it straight.

! **NOTE: Damage to the printer and material cartridge**
If the printer is not going to be used for a prolonged period of time, remove the material cartridge from the printer.





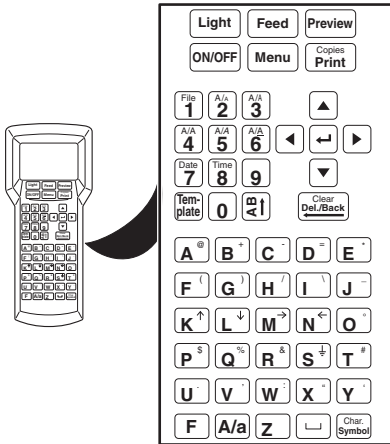

2.5 Switching on the device

- Switch on the printer using the green **ON/OFF** key.
- Press the green **ON/OFF** key until the display lights up.







3 Operating elements

Figure 3-1 Operating elements



Operating elements		
Green keys		
	On/Off switch	
	Function key, is used to switch to the assignment labeled green when pressing a key (e.g., @ instead of A).	
Black keys		Function key pressed
	Display lighting	–
	Material feed	–
	Preview of the print result	–
	Call menu In a value selection: the value is accepted and you are returned to the input screen	–
	Start printing	Multiple copies

Operating elements

Operating elements		
Turquoise keys		Function key pressed
	Selection of templates	–
	Changes the text alignment (horizontal/vertical)	–
	Confirm entry, new line (up to six lines are possible)	–
	In the menu: back to the previous level In the input screen: delete previous character	In the input screen: delete entire contents
	Switches between upper case and lower case letters	–
	Space	–
	Selection of symbols	Selection of special characters, e.g., â, È, ï, Ç
Gray keys		Function key pressed
Numbers	Entry of numbers 0 - 9	1 = File 2 = Font size 3 = Narrow 4 = Bold 5 = Italic 6 = Underline 7 = Date 8 = Time
Letters	Letters A - Z	Selection of the assignment labeled green
Arrow keys	Line change, navigating in the menu	

3.1 Display

The first line in the display shows the settings selected.

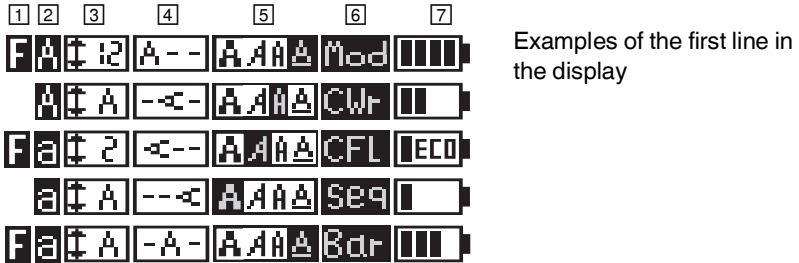

Examples of the first line in the display

- 1 “F” indicates that the green **F** function key has been pressed. The function key is used to switch to the assignment labeled green when pressing a key (e.g., @ instead of A).
- 2 Indicates whether upper case or lower case letters are being used. Can be switched using the turquoise **A/a** key.
- 3 Indicates the selected line height in mm. The “A” stands for “auto”. The line height is adjusted according to the space available. Can be switched using number key “2” if the function key has been activated simultaneously. To set the desired height in mm, press number key “2” several times (Auto Size, 2 mm ... 22 mm)
- 4 Alignment of text
The turquoise **A** key can be used to switch the text alignment. The text alignment switches in the following order:

1. horizontal – centered	4. vertical – right-aligned
2. vertical – centered	5. horizontal – left-aligned
3. horizontal – right-aligned	6. vertical – left-aligned
- 5 Text format (bold, italic, narrow, underline). Can be switched using the number keys if the function key has been activated simultaneously.
3 = narrow, 4 = bold, 5 = italic, 6 = underline
- 6 Print layouts for specific requirements
 - Rows of labels with a fixed width (“Mod”, see Section 4.1.5)
 - Cable marking (“CWr”, see Section 4.1.6)
 - Cable flags (“CFL”, see Section 4.1.7)
 - Insert bar code (“Bar”, see Section 4.1.3)
 - Insert number sequence (“Seq”, see Section 4.1.4)
- 7 State of the power supply

3.2 Menu

Use the arrow keys to navigate through the menu. Press the \downarrow key to select an entry and  to go back.

Changing the language

The menu is set to English by default. To change the language, proceed as follows:



- Press the black  key.
- Select “A. Setup”. Press the \leftarrow key.
- Select “1. Language”. Press the \leftarrow key.
- Select a language.
- Press the \leftarrow key to select an entry. Go back with  or .

Table 3-1 Menu

Level 1	Level 2	Level 3	Level 4	Description	
1. File	1. Save			Save marking	
	2. Load			Load stored marking (1 to 20 files)	
	3. Print			Print stored marking	
	4. Delete			Delete stored marking	
2. Font	1. Size	Auto Size	Font is adjusted according to space available		
		2 mm ... 22 mm	Font size in mm	ABC	
	2. Style	1. Bold	Bold		ABC
		2. Italic	Italic		<i>ABC</i>
		3. Narrow	Narrow		ABC
		4. Underline	Underline		<u>ABC</u>
		5. Mirror	Mirrored		ƆBA

Table 3-1 Menu [...]

Level 1	Level 2	Level 3	Level 4	Description	
3. Symbol	Punctuation			Punctuation marks	! " #
	General symbols			General symbols	§ © ®
	Units			Units	\$ £ ¢
	Electr. General			Electrical symbols	⚡ ⚡ ⚡
	Electr. Comp.			Electrical components	☐
	Home Electrics			Home electrics	☀ ⚡
	Safety Signs			Safety symbols	⚠ ⚠
	Superscript			Superscript characters	± - +
	Subscript			Subscript characters	± - +
	Arrows			Arrows	← ↑ →
	Greek Upper Case			Greek upper case letters	ΑΒΓΔ
	Greek Lower Case			Greek lower case letters	αβγδ
	Mathematical Character			Mathematical symbols	± ≥ ≠
4. Orientation	1. Horizontal			Horizontal text alignment	ABC
	2. Vertical			Vertical text alignment	ABC ABC
5. Alignment	1. Left			Left-aligned text	ABC
	2. Center			Centered text	ABC
	3. Right			Right-aligned text	ABC

Operating elements

Table 3-1 Menu [...]





Level 1	Level 2	Level 3	Level 4	Description
6. Frame	1. No Frame			No frame
	2. Dotted			Frame, dashed line 
	3. Thin			Frame, thin line 
	4. Medium			Frame, standard line 
	5. Thick			Frame, thick line 
7. Margin	1. Least			1 mm
	2. Small			2 mm
	3. Medium			5 mm
	4. Large			10 mm
	5. Text-equal			All margins are adjusted evenly according to the text size
	6. User Set			Set fixed width from right and left margin (1 mm ... 400 mm)
8. Length	1. Auto Length			The length of the printed text depends on the marking and the set margin
	2. User Set			Set fixed length (4 mm ... 400 mm)

Table 3-1 Menu [...]

Level 1	Level 2	Level 3	Level 4	Description	
9. Template	1. Normal			Empty template	
	2. Barcode	Barcode Type	Code 39, Code 128, Interleaved 2/5, Codabar, EAN-8, EAN-13, EAN-128, UPC-A		You can implement Micro QR Code, DataMatrix, and PDF417 via PROJECT complete
		Width	Small, Medium, Large		Bar code width
		Display Text	No, Yes		The text encrypted in the bar code is displayed below the bar code
		Check Code	No, Yes		A check digit is added, if required
	3. Sequence	Auto Length	StaVal		Start value of a sequence of numbers (2 = 2, 3 ...)
			IncVal		Increment of a sequence of numbers (2 = 2, 4, 6...)
			EndVal		End value of a sequence of numbers (5 = ... 3, 4, 5)
			SepLine		Separator line
			Orient.		Text alignment of the module: horizontal or vertical
			Prefix		Prefix of a sequence of numbers (-X = -X1, -X2...)
			Suffix		Suffix of a sequence of numbers (-X = 1-X, 2-X...)
	Copies		Repetitions (2 = 1, 1, 2, 2...)		

Table 3-1 Menu [...]

Level 1	Level 2	Level 3	Level 4	Description	
9. Template	3. Sequence	Pitch	StaVal	Start value of a sequence of numbers (2 = 2, 3 ...)	
			IncVal	Increment of a sequence of numbers (2 = 2, 4, 6...)	
			EndVal	End value of a sequence of numbers (5 = ... 3, 4, 5)	
			Pitch	Width for each module, pitch	
			SepLine	Separator line	
			Orient.	Text alignment of the module: horizontal or vertical	
			Prefix	Prefix of a sequence of numbers (-X = -X1, -X2...)	
			Suffix	Suffix of a sequence of numbers (-X = 1-X, 2-X...)	
	Copies	Repetitions (2 = 1, 1, 2, 2...)			
	4. Module	Total			Number of modules, [1 ... 64] one line, [1 ... 32] two lines
			Pitch		Width for each module, pitch
			Factor		Factor for the width
			SepLine	Dotted, Thin, Medium, Thick, Off	Separator line
			Orient.	Hor., Ver.	Text alignment of the module: horizontal or vertical
	5. Cable Wrap	Horizontal	Auto Length	Length of the cable marking is adjusted according to space available	
			User Set	User-defined length of the cable marking (4 mm ... 400 mm)	
		Vertical	Diameter	Diameter of the cable (4 mm ... 100 mm)	
			Cross section	Cross-section of the cable (0.25 mm ² /AWG 22 ... 50 mm ² /AWG 0)	

Table 3-1 Menu [...]

Level 1	Level 2	Level 3	Level 4	Description
9. Template	6. Cable Flag	Orient.	Hor., Ver.	Text alignment of the cable flag
		Wrap Length	Diameter	Diameter of the cable (4 mm ... 100 mm)
			Cross section	Cross-section of the cable (0.25 mm ² /AWG 22 ... 50 mm ² /AWG 0)
		Flag Length	Auto Length, User Set	Length of the cable flag: automatic or user-defined 4 mm ... 400 mm
		Center Line	Off, Dotted, Thin, Medium, Thick	Center line as folding guide
A. Setup	1. Language	English German French Spanish Italian Czech Dutch Hungarian Polish Portuguese Turkish Korean Japanese		Languages for the menu

Operating elements

Table 3-1 Menu [...]

Level 1	Level 2	Level 3	Level 4	Description
A. Setup	2. Unit	mm, inch		Units in millimeters or inches
	3. Feed Length	Cur.		Feed length. Default: 10 mm
		Max.		Maximum 400 mm
		Min.		Minimum 7 mm
	4. Display Light	Always On		The display lighting will remain switched on
		Set Time	Cur.	The display lighting is switched off after a specific time. Default: 15 s
			Max.	Maximum 600 s
			Min.	Minimum 15 s
	5. Auto Off	Always On		The device will remain switched on
		Set Time	Cur.	The device is switched off after a specific time. Default: 1 min
			Max.	Maximum 60 min
			Min.	Minimum 1 min
	6. Information	Model		Device type
		Firmware		Firmware version status
		Serial Number		Serial number
Cartridge Type		Type of the inserted material cartridge		
Remain Length		Remaining material length (estimated)		

Table 3-1 Menu [...]

Level 1	Level 2	Level 3	Level 4	Description	
A. Setup	7. Date	Year		Specify the current date	
		Month			
		Day			
		Date Format		Format for day (dd), month (mm), and year (yyyy) Example: dd/mm/yyyy → 23/06/1977 yyyy-mm-dd → 1977-06-23	
	8. Time	Hour		Specify the current time	
		Minute			
		Second			
		Time Format		24-hour format: hh:mm:ss→ 13:24:59 12-hour format: hh:mm:ss am/pm → 01:24:59 pm	
	9. Reset All				Reset to default values

4 Creating the marking

4.1 Creating the marking on the display

4.1.1 Entering and formatting text

Example 1

Figure 4-1 Switching between upper case and lower case letters

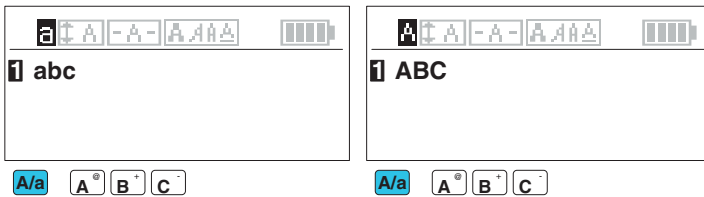

Example 2

Figure 4-2 Using the alternative key assignment

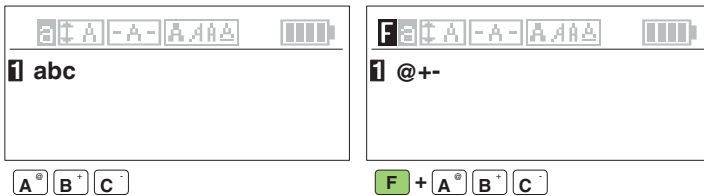

Example 3

Figure 4-3 Changing the text direction

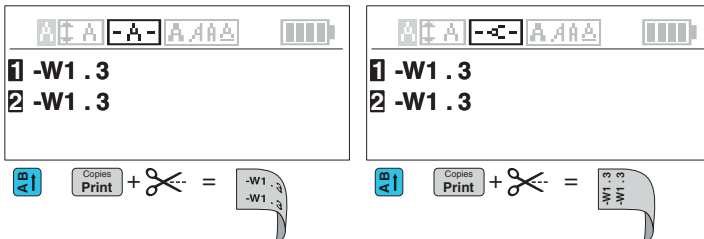

Example 4

Figure 4-4 Changing font sizeExample 5

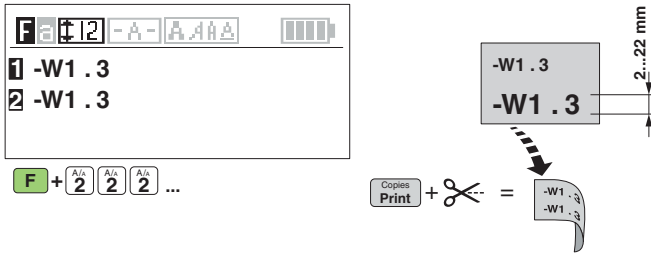
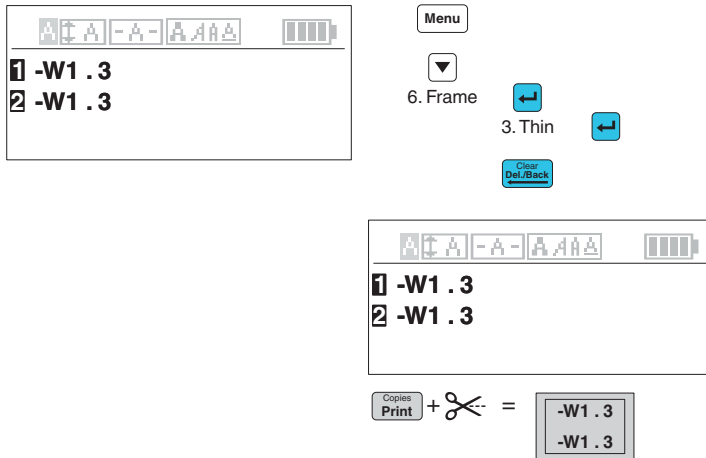





Figure 4-5 Adding a frame around the text



i You can set fixed values, e.g., a fixed width for the margin or a fixed length for the label. To ensure dimension accuracy, the printer transports a little piece of material before printing. The printer requests that you cut off this piece before printing.

4.1.2 Inserting symbols

- Press the turquoise  key.
- Select a category using the arrow keys.
 - Punctuation marks
 - General symbols
 - Units
 - Electrical symbols
 - Electrical components
 - Home electrics
 - Safety symbols
 - Superscript characters
 - Subscript characters
 - Arrows
 - Greek upper case letters
 - Greek lower case letters
 - Mathematical symbols
- Press the  key to select an entry. Go back with .
- Select a symbol using the arrow keys. The selected symbol is highlighted in black.
- Once you have selected a symbol, press the black  key.
The symbol is accepted and you are returned to the input screen.

An overview of all the available symbols can be found under [“Overview of the symbols” on page 44.](#)

4.1.3 Inserting a bar code

You can arrange for labels to be marked with a bar code. Move the cursor to the position at which the sequence is to be located.



When you select this template, the entered marking is deleted. First create a template and then enter the marking.





- Press the turquoise key.
- Select “2. Barcode” . Press the key.
- Select the desired settings (see below).
- Press the key to select an entry. Go back with or .

Selection		Possible entry	Example
Barcode Type	You can implement Micro QR Code, DataMatrix, and PDF417 via PROJECT complete	[Code 39, Code 128, Interleaved 2/5, Codabar, EAN-8, EAN-13, EAN-128, UPC-A]	
Width	Bar code width	[Small, Medium, Large]	
Display Text	The text encrypted in the bar code is displayed below the bar code	[No, Yes]	
Check Code	A check digit is added, if required	[No, Yes]	

“Bar” is displayed in the input screen.

4.1.4 Numbering labels automatically

You can arrange for labels to be marked with continuous numbers or letters. Move the cursor to the position at which the sequence is to be located.

- Press the turquoise  key.
- Select “3. Sequence”. Press the  key.
- Select the desired settings (see below).
- Press the  key to select an entry. Go back with  or .

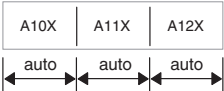
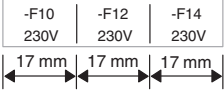
Selection A		Example
Auto Length	The length of the printed text depends on the marking and the set margin	
Pitch	A width can be specified for each number sequence	

Setting the number sequence

Selection B		Possible entry	Example
StaVal	Start value	[1 ... 99, aa ... zz, AA ... ZZ]	9 = 9, 10, 11 ... 99
IncVal	Increment	[1 ... x]	2 = 2, 4, 6, 8 ... 98
EndVal	End value	[1 ... 99, aa ... zz, AA ... ZZ]	40 = ... 38, 39, 40
Pitch Not available for "Auto Length"	Width for each module	[3 mm ... 999.9 mm in 0.1 mm increments, mm, or inches]	
SepLine	Separator line	[Dotted, Thin, Medium, Thick, Off]	
Orient.	Text alignment of the module	[Hor., Ver.]	
Prefix	Prefix	[max. 6 characters]	-X = -X1, -X2, -X3, ...
Suffix	Suffix		Y = 1Y, 2Y, 3Y ...
Copies	Number of repetitions for each value	[1 ... 99]	3 = 1, 1, 1, 2, 2, 2

"Seq." is displayed in the input screen.

4.1.5 Creating label modules with a fixed width

To mark electronic modules, such as terminal blocks or fuses, one label can be printed for all modules. A width (“Pitch”) can be specified for each module.



When you select this template, the entered marking is deleted. First create a template and then enter the marking.

- Press the turquoise key.
- Select “4. Module”. Press the key.
- Select the desired settings (see page 30).
- Press the key to select an entry. Go back with or .
- “Mod” appears in the display.
- Using the arrow keys, select the module for which you want to enter the marking. For three modules, e.g., “Page01”, “Page02”, “Page03”.
- To exit the “Module” template, press the green function key + .

Example 1

	F1 230 V	F2-4 400 V	F5 230 V
Total	1	2	3
Pitch + Factor	1 x 17.5 mm	3 x 17.5 mm	1 x 17.5 mm
SepLine	Medium		
Orient.	Horizontal		

Example 2

	L1	L2	L3	N
Total	1	2	3	4
Pitch + Factor	1 x 8.5 mm			
SepLine	Thick			
Orient.	Vertical			

Selection		Possible entry	Example
Total	Number of modules	[1 ... 64] one line, [1 ... 32] two lines	12 = 12 modules next to each other
Pitch	Width for each module	[3 mm ... 100 mm in 0.1 mm increments, mm, or inches]	10.1 = 10.1 mm wide modules
Factor	Factor for the width	[0.1 ... 9.9, in 0.1 increments], factor for the width	2.5 = width x 2.5
SepLine	Separator line	[Dotted, Thin, Medium, Thick, Off]	
Orient.	Text alignment of the module	[Hor., Ver.]	

4.1.6 Creating cable markings

When marking cables or conductors, it may be useful to attach a marking that is readable around the cable.

Figure 4-6 Cable marking

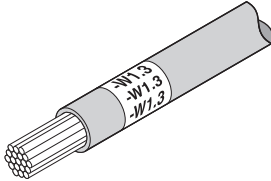

i When you select this template, the entered marking is deleted. First create a template and then enter the marking.

- Press the turquoise **Template** key.
- Select "5. Cable Wrap". Press the **Enter** key.
- Select the desired settings (see below).
- Press the **Enter** key to select an entry. Go back with **Clear Del./Back** or **Menu**.
- You can select measurements with the arrow keys. Some measurements can also be entered directly by using the number keys.

The following settings can be made.

Selection		Possible entry	Example
5. Cable Wrap	Horizontal text alignment	[Auto Length, User Set]	
	Vertical text alignment	[Diameter, Cross section]	

When using **horizontal text alignment**, the optimum width of the label can be determined automatically or you can specify a fixed width.

When using **vertical text alignment**, enter the diameter or the cross-section of the cable. The printer then determines the optimum length.





4.1.7 Creating cable flags

Cable flags can be used for the large-surface marking of cables or lines. To do so, enter the marking for the front side. The back side is printed automatically with the same marking.

Figure 4-7 Example of a cable flag



 When you select this template, the entered marking is deleted. First create a template and then enter the marking.

- Press the turquoise  key.
- Select “6. Cable Flag” . Press the  key.
- Select the desired settings (see below).
- Press the  key to select an entry. Go back with  or .
- You can select measurements with the arrow keys. Some measurements can also be entered directly by using the number keys.

The following settings can be made.

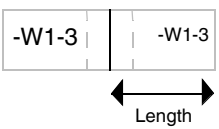
Selection		Possible entry	Example
Orient.	Text alignment	[Hor., Ver.]	
Wrap Length	Diameter or cross-section of the cable	[Diameter, Cross section]	
Flag Length	Length of the cable flag	[Auto Length, User Set]	
Center Line	Center line	[Off, Dotted, Thin, Medium, Thick]	

Enter the diameter or the cross-section of the cable. The printer then determines the optimum length. Alternatively, you can specify a fixed length for the flag.

4.2 Creating the marking on the PC

PROJECT complete marking can be used to create markings on a PC, which are tailored to the Phoenix Contact marking material.

Select the THERMOMARK GO.K as the printer. You will be provided with a template list of materials that are suitable for this printer.

The PROJECT complete marking software is supplied with the printer. The marking software is also available to download at phoenixcontact.net/qr/1050453.

Connecting to a computer via USB



NOTE: Malfunctions during operation due to insufficient or missing shielding

Make sure that all connecting cables connected to the printer are shielded.



A printer driver must be installed if a USB interface is to be used for connection. The printer driver can be found on the Internet at phoenixcontact.net/qr/1184146.

- Switch on the PC.
- Exit all programs that are currently running.
- Switch on the THERMOMARK GO.K.
- Connect the PC to the THERMOMARK GO.K using the supplied USB cable.
- Start the installation of the printer driver. Follow the on-screen instructions.

Following successful installation, an icon for the THERMOMARK GO.K appears in the Windows “Devices and Printers” system folder.

Then set up the THERMOMARK GO.K in PROJECT complete marking. Add the THERMOMARK GO.K as a printer.

4.3 Printing

- Press the  key to print the marking once.
- To print multiple copies, press the  key and the green  function key at the same time.
- If printing multiple labels, you can choose to cut the labels right away or later. If you want to cut the labels later, the printer can add a line at the cutting position.
For the setting with cut, you are requested to cut. After the cut, the device continues printing.

5 Maintenance and troubleshooting

5.1 Cleaning

5.1.1 Cleaning the printer



NOTE: Damage to the printer due to abrasive cleaning agents

Do not use abrasive cleaners or aggressive solvents to clean the outer surfaces.

- Remove dust and paper fluff in the printing area with a soft brush.
- Clean the outer surfaces with a damp cloth. Use an all-purpose cleaner for higher levels of contamination.

5.1.2 Cleaning the print head and pressure roller

During printing, substances may be deposited on the print head or pressure roller. It is important to clean the print head and pressure roller regularly. This ensures consistent printing quality and extends the service life of the printer.

- !** **NOTE: Damage to the print head**
Do not touch the protective glass of the print head with your fingers or sharp objects. Do not use sharp or hard objects to clean the print head.

Figure 5-1 Print head (1) and pressure roller (2)

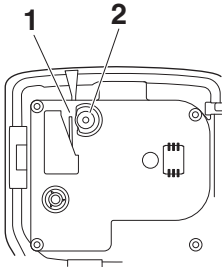

- Open the cover of the material cartridge and remove the material cartridge.
- Clean the print head line and pressure roller with a felt stick (e.g., CLEANING STICK, 5146697) soaked in isopropyl alcohol.
- Allow the print head to dry for two to three minutes.

5.2 Troubleshooting

Table 5-1 Troubleshooting

Problem	Possible cause	Remedy
Print image is blurred or missing in places	Print head or pressure roller is dirty	Clean the print head and pressure roller (see 5.1.2)
	The tension of the ink ribbon is too low	To increase the tension of the material, turn the ink ribbon reel.
Material is not being supplied	Not enough material has been unwound from the material cartridge	Unwind the material approx. 5 mm from the material cartridge. To increase the tension of the material, turn the ink ribbon reel.
	Material is stuck in the printer	Carefully remove the material from the printer. Cut off damaged material. Unwind the material approx. 5 mm from the material cartridge. To increase the tension of the material, turn the ink ribbon reel.
	Material cartridge is empty	Insert a new material cartridge (see 2.4)
	Compartment for material cartridge is open	Close compartment
Material is being supplied but not printed	Ink ribbon is torn	Insert a new material cartridge (see 2.4)
Printer is loud	Material cartridge is not inserted correctly	Insert material cartridge correctly (see 2.4)
	Material cartridge is defective	Insert a new material cartridge (see 2.4)
	Compartment for material cartridge is open	Close compartment
Printer prints slowly	Printing speed is automatically adjusted	When the battery state of charge is below a certain level, the printing speed is reduced. This ensures consistently high printing quality.

Table 5-1 Troubleshooting

Problem	Possible cause	Remedy
The printer cannot be switched on	Batteries are dead	Change batteries
	Batteries are inserted incorrectly	Insert batteries correctly
	Rechargeable battery is dead	Recharge battery
	Rechargeable battery is inserted incorrectly	Insert rechargeable battery correctly
	No power supply	Connect power supply unit
Printer switches off automatically	Auto off function is activated	Check menu entry (see "A. Setup, 5. Auto Off")
Battery is not charged	Battery is inserted incorrectly	Insert battery correctly
	No power supply	Connect power supply unit
	Battery is defective	Dispose of battery properly. Insert new battery





Operating elements

Table 5-1 Troubleshooting

Problem	Possible cause	Remedy
Display lighting switches off automatically	Auto off function for the display lighting is activated	Check menu entry (see "A. Setup, 4. Display Light")
No input possible	General system error	Switch device off and on again. Disconnect the device from the power supply. Remove batteries. Insert new ones.
Cutter is stiff	Type of material being used	Some materials have a higher material thickness. These materials need more cutting force than other materials.

5.2.1 Error messages

Table 5-2 Error messages

Error message	Possible cause	Remedy
“Please Cut”	Printer is waiting for the material to be cut	Press the cutter lever
“Input Too Long”	The limit on the number of characters that can be printed has been reached	Reduce number of characters or increase label length
“End of Tape”	Material cartridge is empty	Insert new material cartridge
“No Tape”	Material cartridge not found	Insert material cartridge
“No Cartridge”	No material cartridge inserted	Insert material cartridge
“No Lines Left”	The limit on the number of lines that can be printed has been reached	Reduce number of lines or use wider material
“Cutter Error”	Cutter was used while printer was printing. Printing is interrupted.	Press any key (except  or )
“Press Any Key”	Printer is awaiting input	Press any key (except  or )

5.3 Repairs



WARNING: Hazard to operational safety

Incorrect operation or modifications to the device can endanger your safety or damage the printer. Do not repair the device yourself. If the device is defective, please contact Phoenix Contact.

5.4 Firmware update

To benefit from improvements and function extensions, you can download a firmware update and a firmware update tool at phoenixcontact.net/qr/1184146.

5.5 Disposal



The device contains valuable recyclable materials, which should be utilized. Dispose of the printer separately from other waste, i.e., via an appropriate collection site.



Dispose of the material cartridge separately from other waste, i.e., via an appropriate collection site.



Dispose of the battery separately from other waste, i.e., via an appropriate collection site.

6 Appendix

6.1 Technical data

Technical data	
Resolution	203 dpi
Print mode	Thermal transfer
Print speed	12 mm/s
Print length	7 mm ... 2200 mm
Print width, maximum	24 mm
Interfaces	USB
Display and operation	2.5" LCD display, ABC keyboard
Voltage	100 V AC ... 240 V AC, 50/60 Hz
Power	36 W, maximum
Temperature	
Operation	+5°C ... +40°C
Storage	-18°C ... +60°C
Transport	-25°C ... +60°C
Humidity	
Operation	10% ... 90%
Storage	5% ... 90%
Transport	5% ... 95%
Approvals	CE, UL, FCC-B, ICES
Approval for Canada as per ICES-003	CAN ICES-3 (B)/NMB-3(B)
Dimensions (H x D x W)	230 mm x 98 mm x 69 mm
Weight	656 g

6.2 Ordering data for accessories

Accessories

Description	Type	Order No.	Pcs./Pkt.
Battery , to supply the THERMOMARK GO.K with power	THERMOFOX/ACCU	0805009	1
Charger , for charging the THERMOFOX/ACCU	THERMOFOX/CHARGER	0805012	1
Wide range power supply unit , with four socket adapters	THERMOFOX/ADAPTER	0805010	1
Transport case , for transporting the THERMOMARK GO.K	THERMOMARK GO CASE	0805002	1
Bag , for transporting the THERMOMARK GO.K	THERMOMARK GO.K/BAG	0805003	1
Belt clip , for fastening to belt	THERMOFOX/BELT CLIP	0805004	1
Magnet , e.g., for attaching to the control cabinet	THERMOMARK GO.K MAGNET HOLDER	0805008	1

6.3 Overview of the symbols

Table 6-1 Overview of the symbols

Category	Symbols
Punctuation	! " # & ' () * , . / : ; ? [\] ^ _ { } ~ ¿ ¡ ' , " „
General symbols	§ © ® ° μ ¶ @
Units	\$ £ ¢ ¤ ¥ € ° ´ ¨ % ‰ °C °F μm mm cm km ft mm² cm² m² km² mm³ cm³ m³ mg kg ml dl μV mV kV μA mA kA mW kW MW mW kW MW pF nF μF Hz kHz MHz GHz dB Pa ha mb
Electr. General	
Electr. Comp.	
Home Electrics	

Operating elements

Table 6-1 Overview of the symbols

Category	Symbols										
Safety Signs											
	Superscript	\pm $-$ $+$ 0 1 2 3 4 5 6 7 8 9 a b c d e f g h i k l m n o q r s t u v w x y z α β γ									
Subscript	\pm $-$ $+$ 0 1 2 3 4 5 6 7 8 9 a b c d e f g h i j k l m n o p q r s t u v w x y z α β γ										
Arrows											

Table 6-1 Overview of the symbols

Category	Symbols
Greek Upper Case	Α Β Γ Δ Ε Ζ Η Θ Ι Κ Λ Μ Ν Ξ Ο Π Ρ Σ Τ Υ Φ Χ Ψ Ω
Greek Lower Case	α β γ δ ε ζ η θ ι κ λ μ ν ξ ο π ρ ς σ τ υ φ χ ψ ω
Mathematical Character	% + - < = ≠ > ≤ ≥ ± ² ³ ¹ ° ¼ ½ ¾ ÷ ‰ × I II III IV V VI VII VIII IX X

6.4 Approvals

6.4.1 FCC

The printer complies with the requirements of FCC Part 15 (B) Rules. Operation is subject to the following two conditions: (1) This device may not cause harmful interference, and (2) This device must accept any interference received, including interference that may cause undesired operation.

Changes or modifications not expressly approved by the party responsible for compliance could void the user's authority to operate the equipment.

This equipment has been tested and found to comply with the limits for a Class B digital device, pursuant to part 15 of the FCC Rules. These limits are designed to provide reasonable protection against harmful interference in a residential installation. This equipment generates, uses and can radiate radio frequency energy and, if not installed and used in accordance with the instructions, may cause harmful interference to radio communications. However, there is no guarantee that interference will not occur in a particular installation. If this equipment does cause harmful interference to radio or television reception, which can be determined by turning the equipment off and on, the user is encouraged to try to correct the interference by one or more of the following measures:

- Reorient or relocate the receiving antenna.
- Increase the separation between the equipment and receiver.
- Connect the equipment into an outlet on a circuit different from that to which the receiver is connected.
- Consult the dealer or an experienced radio/TV technician for help.

6.4.2 ICES

Industry Canada ICES-003: CAN ICES—3 (B)/NMB-3(B)

6.4.3 UL



WARNING: Hazardous moving parts

Keep fingers and other body parts away.

This equipment is not suitable for use in locations where children are likely to be present.

Inserting the battery



WARNING: Explosion hazard

Only use batteries of the stated type. Risk of explosion if the battery or rechargeable batteries are replaced by an incorrect type.



WARNING: Risk of fire

Only operate the device if the battery cover is closed correctly. Combustible material close to the battery compartment may ignite.

To open the battery compartment, push the interlock of the cover into the direction of the connections. Insert the battery with correct polarity and slightly tilted into the battery compartment. Press down the battery. Close the cover.

Insertion de la batterie ou des piles



AVERTISSEMENT : Risque d'explosion

N'utiliser que des batteries ou des piles de type mentionné.

L'utilisation d'un type incorrect peut annuler les mesures de protection.



AVERTISSEMENT : Risque d'incendie

N'utiliser l'appareil que si le couvercle du compartiment des piles est fermé correctement. Les matières inflammables se trouvant à proximité du compartiment des piles peuvent prendre feu.

Pour ouvrir le compartiment des piles, appuyer sur le mécanisme de verrouillage du couvercle en direction des raccordements. Insérer la batterie ou les piles dans le compartiment des piles, légèrement inclinées, en respectant la polarité. Enfoncer la batterie ou les piles. Refermer le capot.



AVERTISSEMENT : Éléments mobiles dangereux

Évitez tout contact avec les doigts et toute autre partie du corps.

Cet équipement ne convient pas à une utilisation dans des lieux pouvant accueillir des enfants.

Please observe the following notes

General Terms and Conditions of use for technical documentation

Phoenix Contact reserves the right to alter, correct, and/or improve the technical documentation and the products described in the technical documentation at its own discretion and without giving prior notice, insofar as this is reasonable for the user. The same applies to any technical changes that serve the purpose of technical progress.

The receipt of technical documentation (in particular user documentation) does not constitute any further duty on the part of Phoenix Contact to furnish information on modifications to products and/or technical documentation. You are responsible to verify the suitability and intended use of the products in your specific application, in particular with regard to observing the applicable standards and regulations. All information made available in the technical data is supplied without any accompanying guarantee, whether expressly mentioned, implied or tacitly assumed.

In general, the provisions of the current general Terms and Conditions of Phoenix Contact apply exclusively, in particular as concerns any warranty liability.

This manual, including all illustrations contained herein, is copyright protected. Any changes to the contents or the publication of extracts of this document are prohibited.

Phoenix Contact reserves the right to register its own intellectual property rights for the product identifications of Phoenix Contact products that are used here. Registration of such intellectual property rights by third parties is prohibited.

Other product identifications may be afforded legal protection, even where they may not be indicated as such.

How to contact us

Internet

Up-to-date information on Phoenix Contact products and our Terms and Conditions can be found on the Internet at:

phoenixcontact.com

Make sure you always use the latest documentation.

It can be downloaded at:

phoenixcontact.net/products

Subsidiaries

If there are any problems that cannot be solved using the documentation, please contact your Phoenix Contact subsidiary.

Subsidiary contact information is available at phoenixcontact.com.

Published by

PHOENIX CONTACT GmbH & Co. KG

Flachsmarktstraße 8

32825 Blomberg

GERMANY

Should you have any suggestions or recommendations for improvement of the contents and layout of our manuals, please send your comments to:

tecdoc@phoenixcontact.com

PHOENIX CONTACT GmbH & Co. KG
Flachmarktstraße 8
32825 Blomberg, Germany
Phone: +49 5235 3-00
Fax: +49 5235 3-41200
E-mail: info@phoenixcontact.com
phoenixcontact.com

© PHOENIX CONTACT

109432_en_00
Order No. —00



INSPIRING INNOVATIONS