

A B C D E F G H

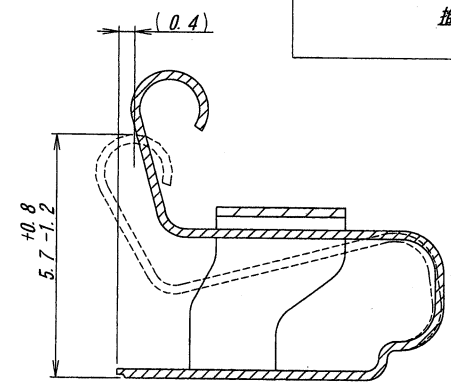

SECT. A-A

接触圧力: 1.0 ± 0.3N (5.7mm高さにて)

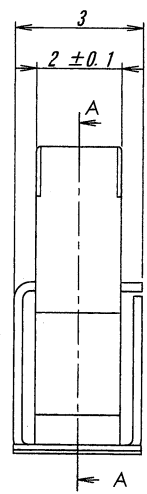
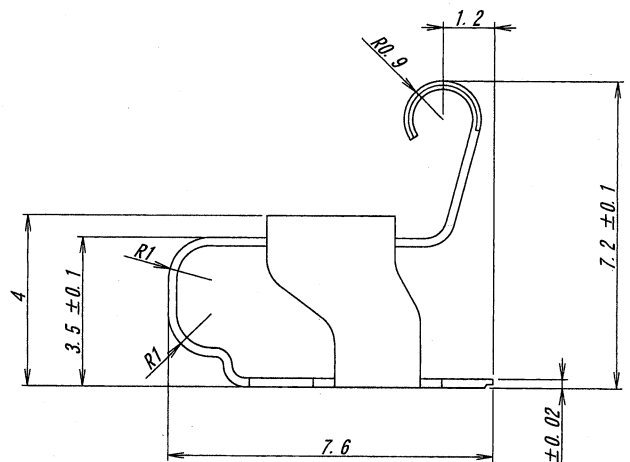
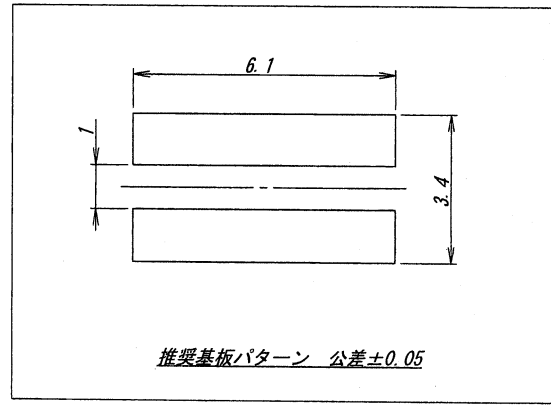
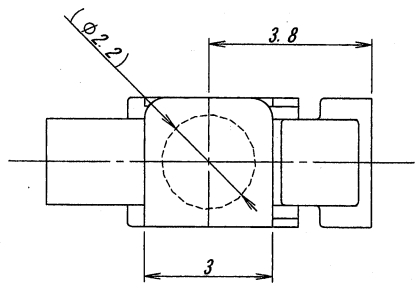
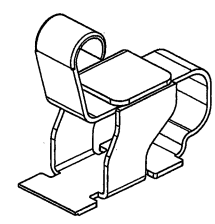
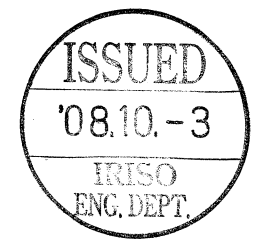
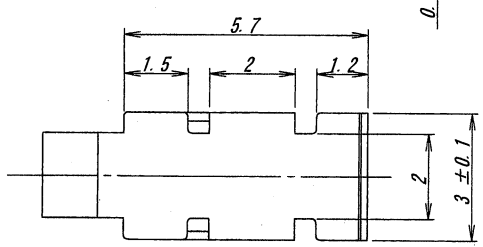

△						MATERIAL 材質	GENERAL TOLERANCES 一般公差	SCALE 尺度	UNIT 単位	TITLE 名称	
△						リン青銅 t=0.20mm	DIM 寸法 ± 0.2	DR '08-4-10	mm	4080シリーズ コンタクト	
△							ANGLE 角度 ±	K Kobayashi	DSN '08-4-10	SERIES 4080 CONTACT	
△								CHK '08	APP '08-4-10	EDP No	
△						FINISH 仕上げ	3RD. ANG. PROJ. 三角法	4. Sasak		PARTS No 部番	
△						ニッケル下地メッキ1.0μm MIN. 金メッキ 接点部 0.1μm MIN. 半田付け部0.05μm MIN.		IRISO ELECTRONICS CO., LTD		4080T-01B-GF	
△	33254	RELEASED	K. K.	10.9	'08-4-10			IPV電子工業株式会社		IPS-4080T-01B-GF	
LTR 記号	ECN No	REVISION RECORD 記	DR	CHK	DATE 年月日					DWG No 図番	REV. 0