

**ABSTRACT**

The LM5158EVM-BST evaluation module showcases the features and performance of the LM5158 device as a wide input voltage, non-synchronous boost converter with dual random spread spectrum. The standard configuration is designed to provide regulate a 12-V output at 1.2 A from an input of 3.3 V to 9 V (load derated by half from < 6-V input), and switching at a frequency of 2.1 MHz.

**Table of Contents**

<b>1 Features and Electrical Performance</b> .....	<b>3</b>
<b>2 Application Schematic</b> .....	<b>5</b>
<b>3 EVM Picture</b> .....	<b>6</b>
<b>4 Test Setup and Procedure</b> .....	<b>7</b>
<b>5 Test Results</b> .....	<b>8</b>
<b>6 Design Files</b> .....	<b>14</b>

**List of Figures**

Figure 2-1. Application Circuit.....	5
Figure 3-1. EVM Picture.....	6
Figure 4-1. Test Setup.....	7
Figure 5-1. Efficiency vs Load.....	8
Figure 5-2. Load Regulation.....	8
Figure 5-3. Thermal Image: $V_{IN} = 3.3\text{ V}$ , $I_{OUT} = 0.6\text{ A}$ , $V_{BIAS} = 3.3\text{ V}$ , No Forced Air Cooling.....	9
Figure 5-4. Thermal Image: $V_{IN} = 3.3\text{ V}$ , $I_{OUT} = 0.6\text{ A}$ , $V_{BIAS} = 12\text{ V}$ , No Forced Air Cooling.....	9
Figure 5-5. Thermal Image: $V_{IN} = 6\text{ V}$ , $I_{OUT} = 1.2\text{ A}$ , $V_{BIAS} = 6\text{ V}$ , No Forced Air Cooling.....	9
Figure 5-6. Steady State, $V_{IN} = 3.3\text{ V}$ , $I_{OUT} = 0.6\text{ A}$ .....	10
Figure 5-7. Steady State, $V_{IN} = 6\text{ V}$ , $I_{OUT} = 1.2\text{ A}$ .....	10
Figure 5-8. Steady State, $V_{IN} = 9\text{ V}$ , $I_{OUT} = 1.2\text{ A}$ .....	10
Figure 5-9. Start-Up, $V_{IN} = 3.3\text{ V}$ , $I_{OUT} = 0.6\text{ A}$ .....	11
Figure 5-10. Start-Up, $V_{IN} = 6\text{ V}$ , $I_{OUT} = 1.2\text{ A}$ .....	11
Figure 5-11. Start-Up, $V_{IN} = 9\text{ V}$ , $I_{OUT} = 1.2\text{ A}$ .....	11
Figure 5-12. Load Transient, $V_{IN} = 3.3\text{ V}$ , $I_{OUT} = 0.4\text{ A}$ to $0.8\text{ A}$ .....	12
Figure 5-13. Load Transient, $V_{IN} = 6\text{ V}$ , $I_{OUT} = 0.6\text{ A}$ to $1.2\text{ A}$ .....	12
Figure 5-14. Load Transient, $V_{IN} = 9\text{ V}$ , $I_{OUT} = 0.6\text{ A}$ to $1.2\text{ A}$ .....	12
Figure 5-15. Control Loop Response, $V_{IN} = 3.3\text{ V}$ , $I_{OUT} = 0.6\text{ A}$ .....	13
Figure 5-16. Control Loop Response, $V_{IN} = 6\text{ V}$ , $I_{OUT} = 0.6\text{ A}$ .....	13
Figure 5-17. Control Loop Response, $V_{IN} = 9\text{ V}$ , $I_{OUT} = 1.2\text{ A}$ .....	13
Figure 6-1. Top Layer and Silkscreen.....	14
Figure 6-2. Top Layer.....	14
Figure 6-3. Signal Layer 1.....	14
Figure 6-4. Signal Layer 2.....	14
Figure 6-5. Bottom Layer.....	14
Figure 6-6. Bottom Layer and Silkscreen.....	14
Figure 6-7. LM5158EVM-BST Schematic.....	15

**List of Tables**

Table 1-1. Electrical Performance Standard Configuration.....	3
Table 1-2. Jumper Description.....	4
Table 4-1. Standard Configuration Jumper Connections.....	7
Table 6-1. LM5158EVM-BST Bill of Materials.....	16

## Trademarks

All trademarks are the property of their respective owners.

## 1 Features and Electrical Performance

The LM5158EVM-BST supports the following features and performance capabilities:

- Tightly regulated output voltage of 12 V with 1% accurate reference voltage
- High conversion efficiency of > 92% at full load
- Constant cycle-by-cycle peak inductor current limit over input voltage range
- Programmable hiccup mode for output overcurrent protection
- User-adjustable soft-start time using  $C_{SS}$
- Output overvoltage protection
- Multiple BIAS pin and VCC pin connections to test multiple configurations
  - BIAS connect to VCC
  - BIAS supplied with external power supply
  - BIAS supplied by output voltage
- Power-good (PGOOD) indicator with selectable pullup source
- 2.1-MHz switching frequency
- External clock synchronization
- Programmable dual random spread spectrum reduces the EMI

### 1.1 Electrical Parameters

**Table 1-1. Electrical Performance Standard Configuration**

PARAMETER	TEST CONDITIONS	MIN	TYP	MAX	UNIT
<b>INPUT CHARACTERISTICS</b>					
Input voltage range $V_{IN}$	Operation	3.3	6	9	V
<b>OUTPUT CHARACTERISTICS</b>					
Output voltage $V_{OUT}$			12		V
Maximum output current $I_{OUT}$	$V_{IN} = 6\text{ V} \sim 9\text{ V}$		1.2		A
	$V_{IN} = 3.3\text{ V} \sim 6\text{ V}$		0.6		
Output Over-voltage $V_{OUT\_OV}$			13.6		V
<b>SYSTEM CHARACTERISTICS</b>					
Switching frequency			2.1		MHz
External clock synchronization		1.8		2.4	MHz
Full load efficiency	$V_{IN} = 6\text{ V}, I_{OUT} = 1.2\text{ A}$		92.4		%
Junction temperature, $T_J$		-40		150	C

## 1.2 Configuration Points

Table 1-2 indicates the available test points and configuration jumpers. These points offer flexibility in configuring the evaluation module and include, but are not limited to:

- The BIAS pin is connected to the following:
  - External supply (VAUX)
  - Input voltage (VIN)
  - Regulated output voltage (VOUT)
  - VCC pin
- The PGOOD pin is supplied by either VCC or VAUX.
- External clock synchronization
- Shutdown signal by pulling the SD pin low
- Four different modes operation to enable and disable the spread spectrum and hiccup mode

**Table 1-2. Jumper Description**

JUMPER	PIN	DESCRIPTION
TP1	VIN+	Positive input voltage sense connection
TP2	SW	Probe point for the switch node of the LM5158 boost circuit
TP3	VOUT+	Positive output voltage sense connection
TP4	VIN–	Negative input voltage sense connection
TP5	GND	Negative output voltage sense connection
TP6	SYNC	Input for the external clock signal. To implement the external clock synchronization, remove the jumper resistor R10 and tie the external signal to TP6 (SYNC).
TP7	VAUX	Supply the BIAS pin from an external supply.
TP8	VOUT+	Loop response positive injection point
TP9	VOUT–	Loop response negative injection point
TP10	AGND	Negative point for external signals
TP11	SD	High signal pulls the UVLO pin to ground entering shutdown mode
J6	Pin 1 to pin 2	Connect VOUT to the BIAS pin of the LM5158 through D3.
	Pin 2 to pin 3	Directly connect VOUT to the BIAS pin of the LM5158.
J7	Pin 1 to pin 2	Connect VIN to the BIAS pin of the LM5158 through D4.
	Pin 2 to pin 3	Directly connect VIN to BIAS pin of the LM5158.
J8	Pin 1 to pin 2	Directly connect VCC to the BIAS pin.
J9	Pin 1 to pin 2	Directly connect VAUX to the BIAS pin.
J10	Pin 1 to pin 2 (NN)	Hiccup mode disabled, spread spectrum disabled
	Pin 3 to pin 4 (HS)	Hiccup mode enabled, spread spectrum enabled
	Pin 5 to pin 6 (HN)	Hiccup mode enabled, spread spectrum disabled
	Pin 7 to pin 8 (NS)	Hiccup mode disabled, spread spectrum enabled
J11	SS (Pin 1)	Monitor the SS pin.
	COMP (Pin 2)	Monitor the COMP pin.
	AGND (Pin 3)	Connection to AGND plane
	SYNC (Pin 4)	Monitor the EN/UVLO/SYNC pin.
	PGOOD (Pin 5)	Monitor the PGOOD pin.
	BIAS-IC (Pin 6)	Monitor the BIAS pin.
	VCC (Pin 7)	Monitor the VCC pin.
J12	Pin 1	Positive input voltage sense connection
	Pin 2	Negative input voltage sense connection
J13	Pin 1	Positive output voltage sense connection
	Pin 2	Negative output voltage sense connection

## 2 Application Schematic

The LM5158EVM-BST is capable of multiple configurations. Figure 2-1 shows the standard configuration of the LM5158EVM-BST where the parameters in Table 1-1 are valid. Section 4.2 describes the correct jumper settings and measurement locations recreate the data presented in Section 5.

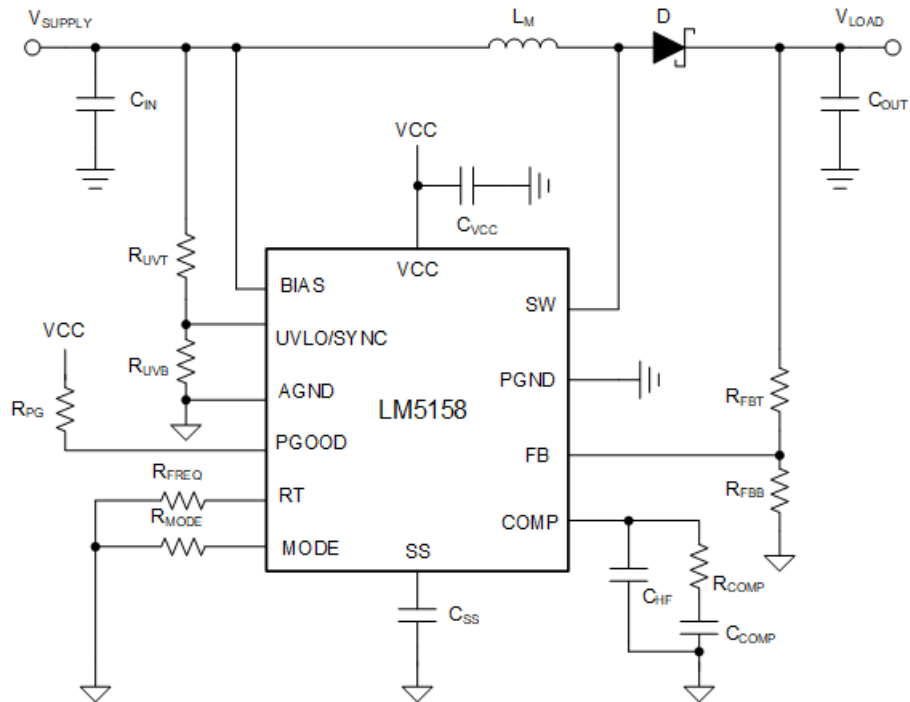

Figure 2-1. Application Circuit

### 3 EVM Picture

Figure 3-1 shows the 3D-rendered picture of the LM5158EVM-BST. The actual board color can differ.

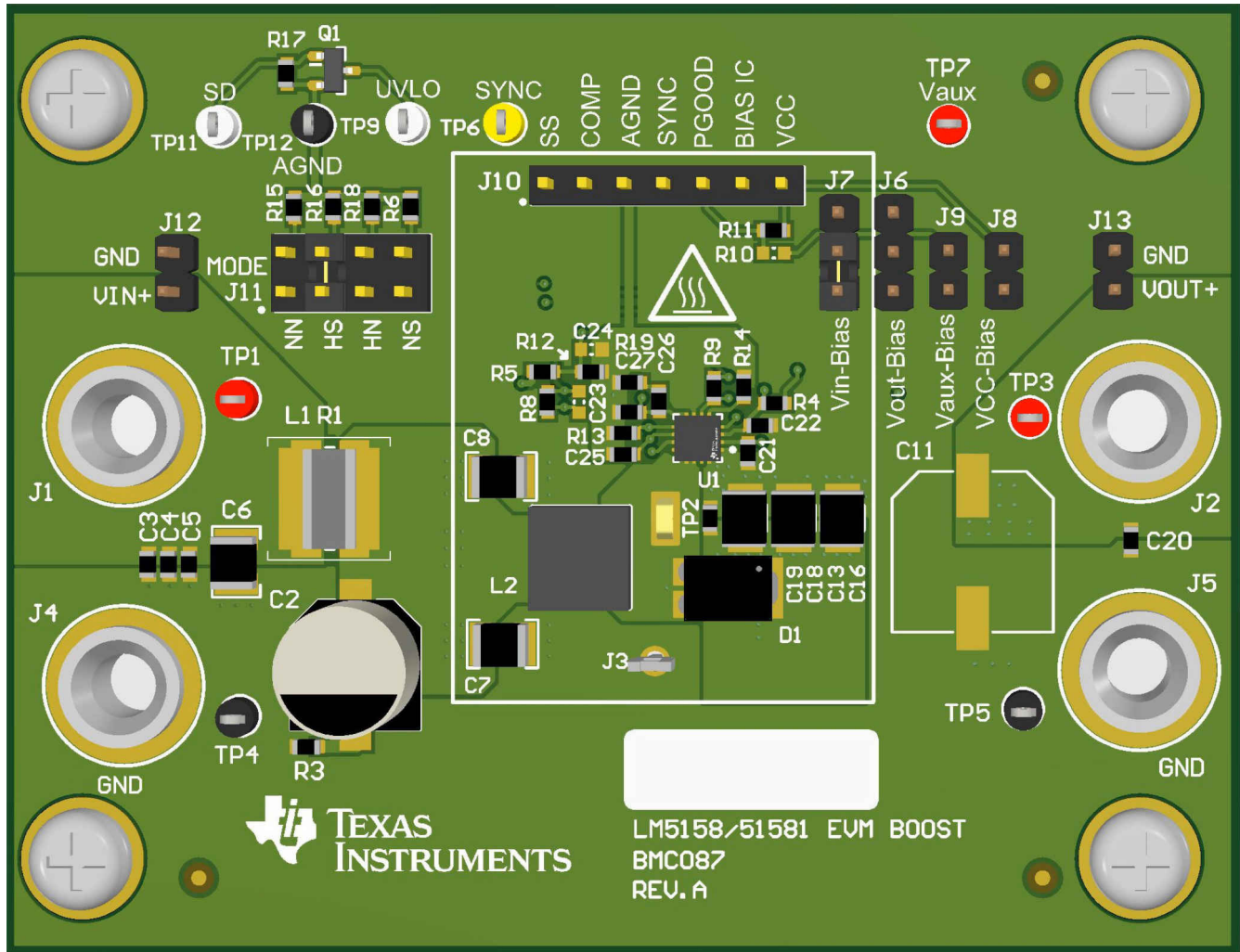

Figure 3-1. EVM Picture

## 4 Test Setup and Procedure

### 4.1 Test Setup

Figure 4-1 shows the correct jumper positions to configure the evaluation module for the typical application, as shown in Figure 2-1. The correct equipment connections and measurement points are shown in Table 4-1

**Table 4-1. Standard Configuration Jumper Connections**

JUMPER	POSITION
J7	Jumper from pin 2 to pin 3
J10	Jumper from pin 3 to pin 4 (HS)

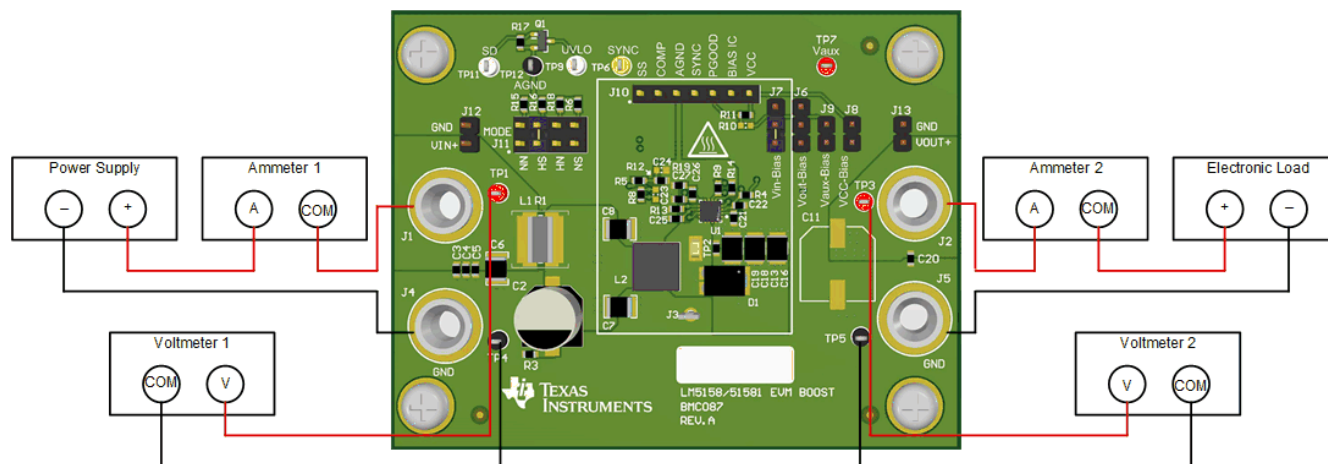

**Figure 4-1. Test Setup**

### 4.2 Test Equipment

- **Power Supply:** The input voltage source (VIN) should be a variable supply capable of 0 V to 10 V and source at least 10 A.
- **Multi-meters:**
  - Voltmeter 1: Input voltage. Connect from VIN+ to VIN–.
  - Voltmeter 2: Output voltage. Connect from VOUT+ to GND.
  - Ammeter 1: Input current. Must be able to handle 10 A. Shunt resistor can be used as needed.
  - Ammeter 2: Output current. Must be able to handle 2 A. Shunt resistor can be used as needed.
- **Electronic Load:** The load should be constant resistance (CR) or constant current (CC) capable. It should safely handle 2 A at 12 V.
- **Oscilloscope:** 20-MHz bandwidth and AC coupling. Measure the output voltage ripple directly across an output capacitor with a short ground lead. It is not recommended to use a long-leaded ground connection due to the possibility of noise being coupled into the signal. To measure other waveforms, adjust the oscilloscope as needed.

## 5 Test Results

Figure 5-1 through Figure 5-17 present the typical performance of the LM5158EVM-BST according to the BOM and the configuration described in Section 4. Based on measurement techniques and environmental variables, measurements can differ slightly than the data presented.

### 5.1 Efficiency Curve

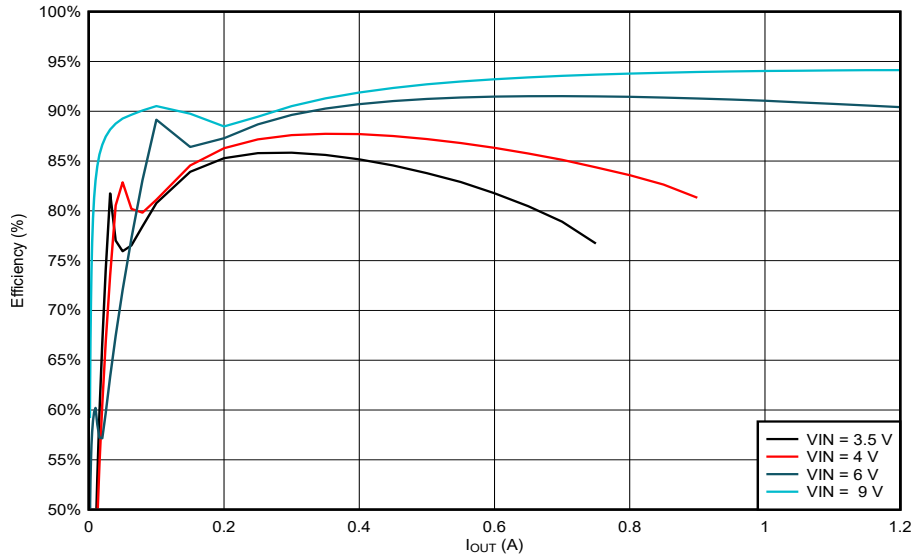

Figure 5-1. Efficiency vs Load

### 5.2 Load Regulation Curve

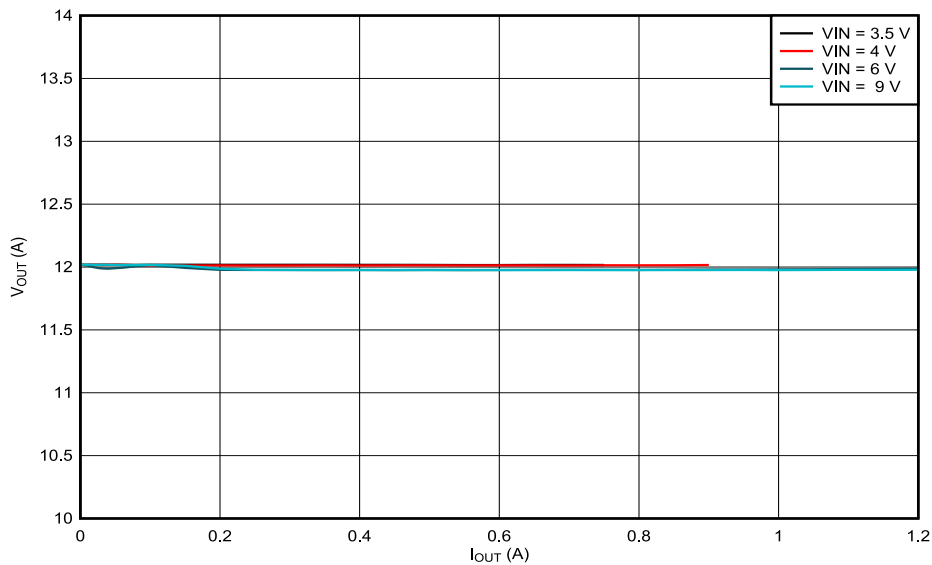

Figure 5-2. Load Regulation



### 5.3 Thermal Performance

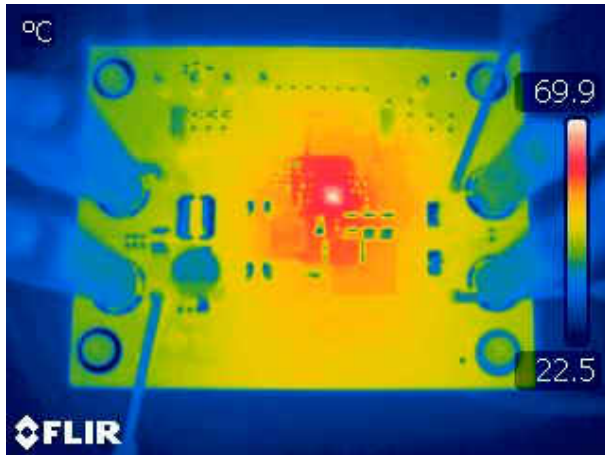

Figure 5-3. Thermal Image:  $V_{IN} = 3.3\text{ V}$ ,  $I_{OUT} = 0.6\text{ A}$ ,  $V_{BIAS} = 3.3\text{ V}$ , No Forced Air Cooling

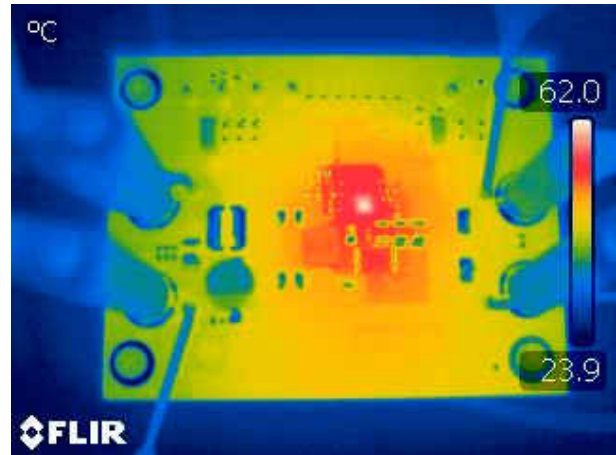

Figure 5-4. Thermal Image:  $V_{IN} = 3.3\text{ V}$ ,  $I_{OUT} = 0.6\text{ A}$ ,  $V_{BIAS} = 12\text{ V}$ , No Forced Air Cooling

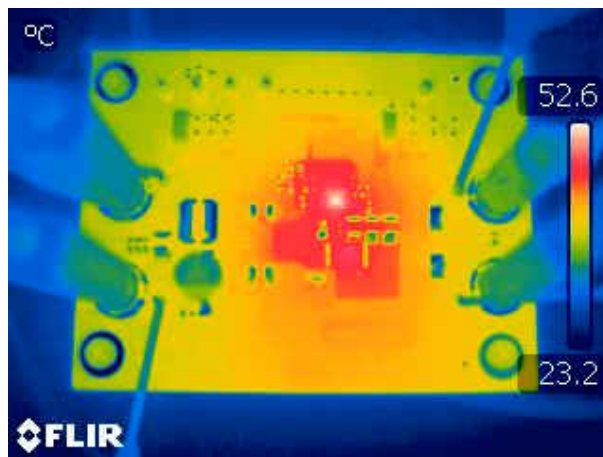

Figure 5-5. Thermal Image:  $V_{IN} = 6\text{ V}$ ,  $I_{OUT} = 1.2\text{ A}$ ,  $V_{BIAS} = 6\text{ V}$ , No Forced Air Cooling

## 5.4 Steady State Waveforms

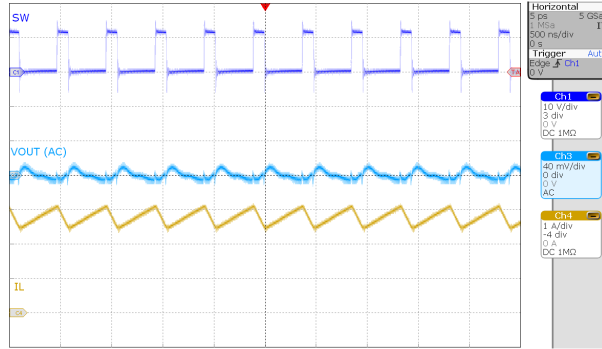

Figure 5-6. Steady State,  $V_{IN} = 3.3 \text{ V}$ ,  $I_{OUT} = 0.6 \text{ A}$

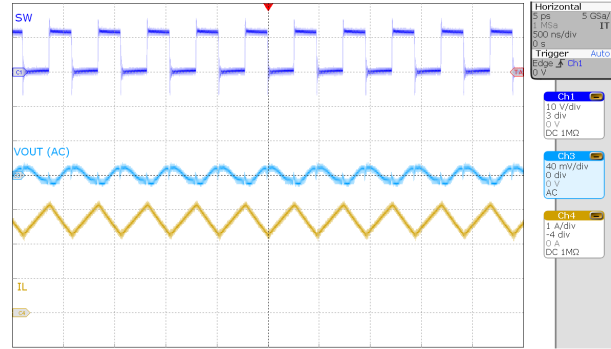

Figure 5-7. Steady State,  $V_{IN} = 6 \text{ V}$ ,  $I_{OUT} = 1.2 \text{ A}$

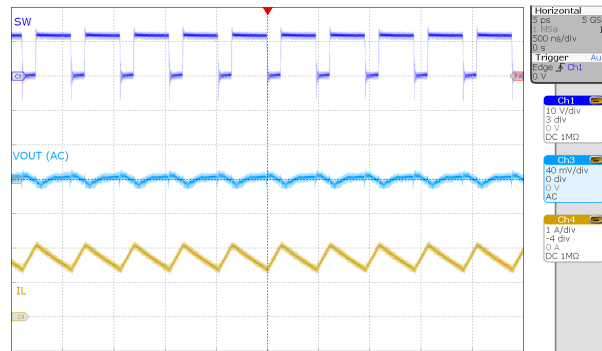

Figure 5-8. Steady State,  $V_{IN} = 9 \text{ V}$ ,  $I_{OUT} = 1.2 \text{ A}$

## 5.5 Start-Up Waveforms

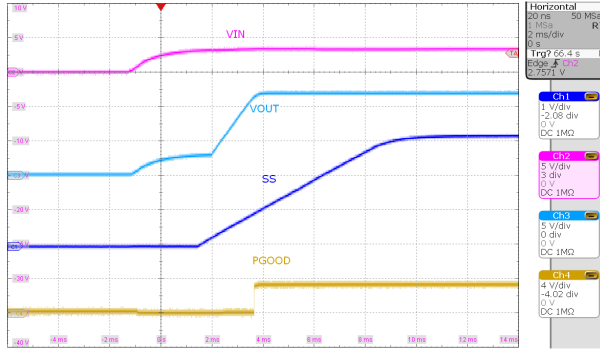

Figure 5-9. Start-Up,  $V_{IN} = 3.3\text{ V}$ ,  $I_{OUT} = 0.6\text{ A}$

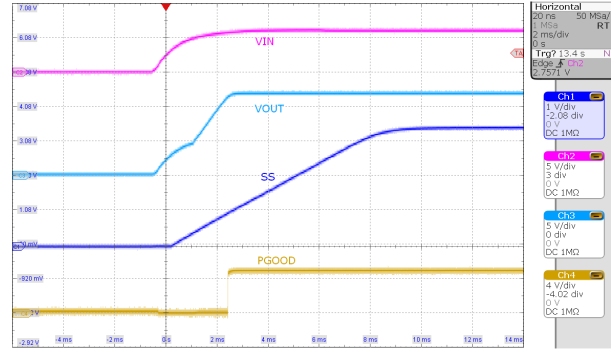

Figure 5-10. Start-Up,  $V_{IN} = 6\text{ V}$ ,  $I_{OUT} = 1.2\text{ A}$

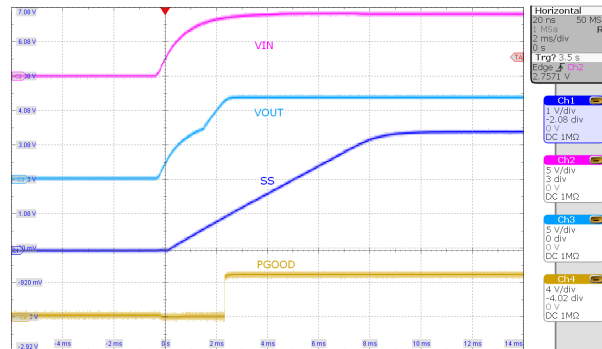

Figure 5-11. Start-Up,  $V_{IN} = 9\text{ V}$ ,  $I_{OUT} = 1.2\text{ A}$

## 5.6 Load Transient Waveforms

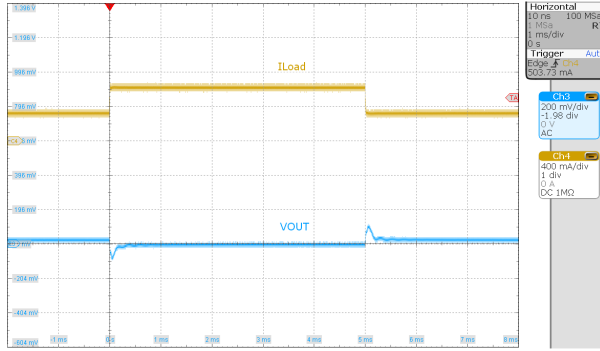

Figure 5-12. Load Transient,  $V_{IN} = 3.3\text{ V}$ ,  $I_{OUT} = 0.4\text{ A}$  to  $0.8\text{ A}$

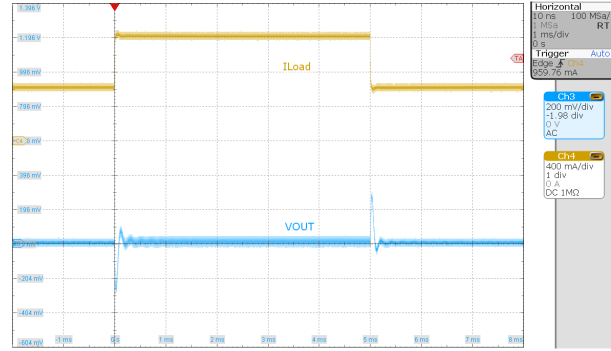

Figure 5-13. Load Transient,  $V_{IN} = 6\text{ V}$ ,  $I_{OUT} = 0.6\text{ A}$  to  $1.2\text{ A}$

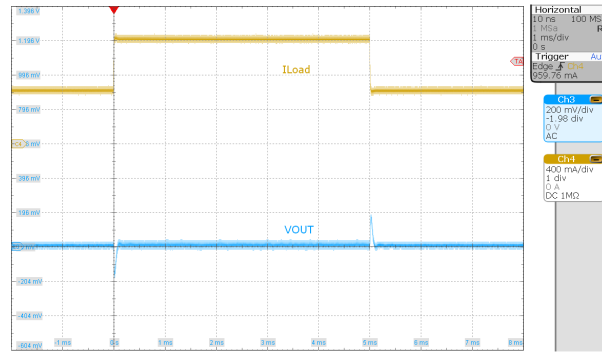

Figure 5-14. Load Transient,  $V_{IN} = 9\text{ V}$ ,  $I_{OUT} = 0.6\text{ A}$  to  $1.2\text{ A}$

## 5.7 AC Loop Response Curves

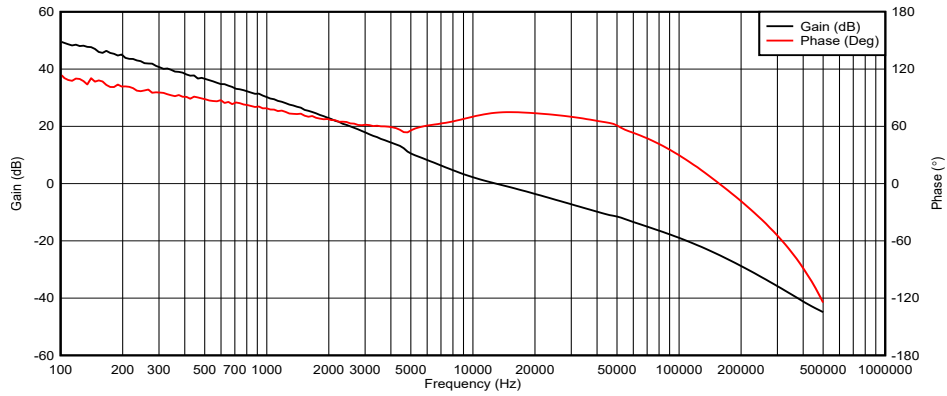

Figure 5-15. Control Loop Response,  $V_{IN} = 3.3\text{ V}$ ,  $I_{OUT} = 0.6\text{ A}$

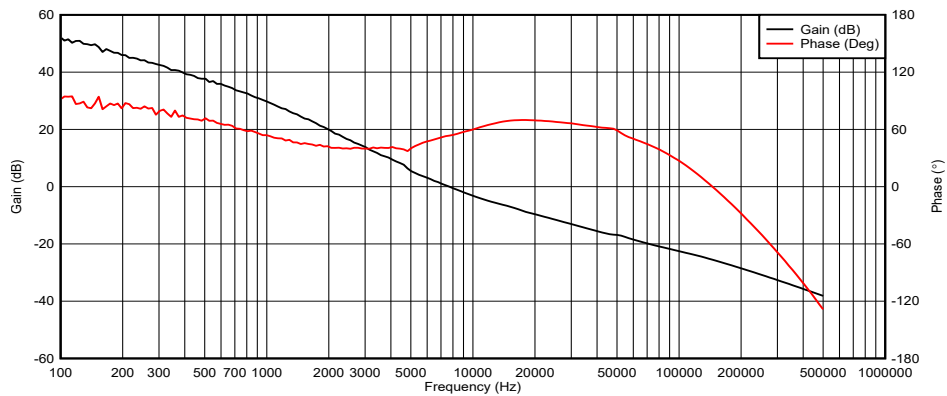

Figure 5-16. Control Loop Response,  $V_{IN} = 6\text{ V}$ ,  $I_{OUT} = 0.6\text{ A}$

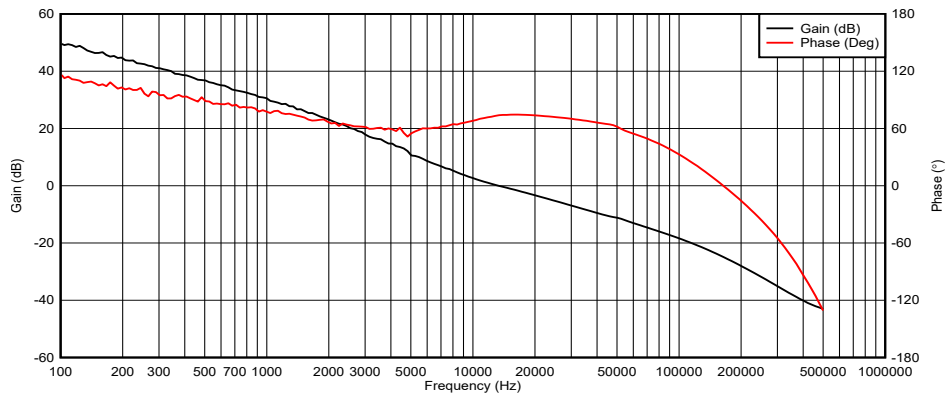

Figure 5-17. Control Loop Response,  $V_{IN} = 9\text{ V}$ ,  $I_{OUT} = 1.2\text{ A}$

## 6 Design Files

Figure 6-1 through Figure 6-6 illustrate the EVM PCB layout images.

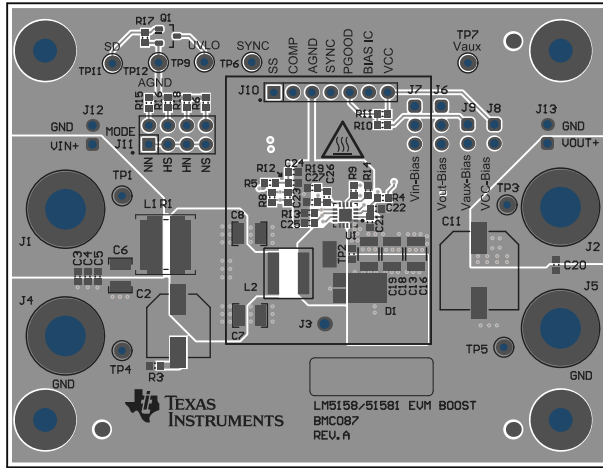

Figure 6-1. Top Layer and Silkscreen

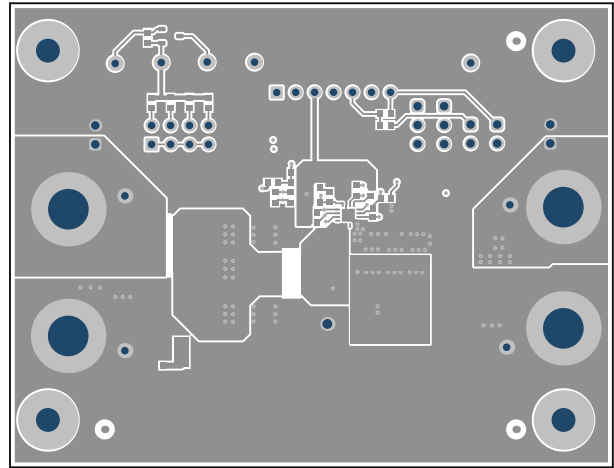

Figure 6-2. Top Layer

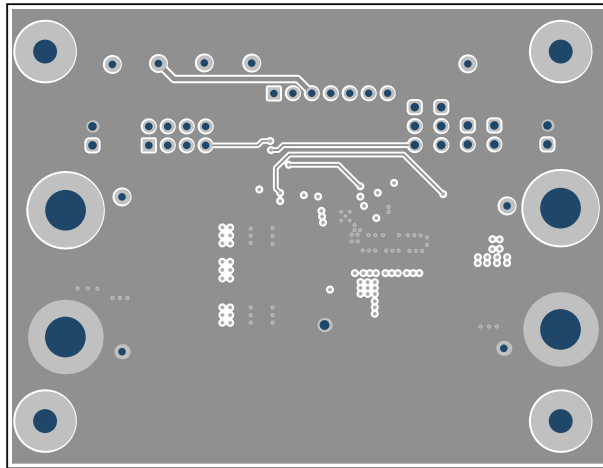

Figure 6-3. Signal Layer 1

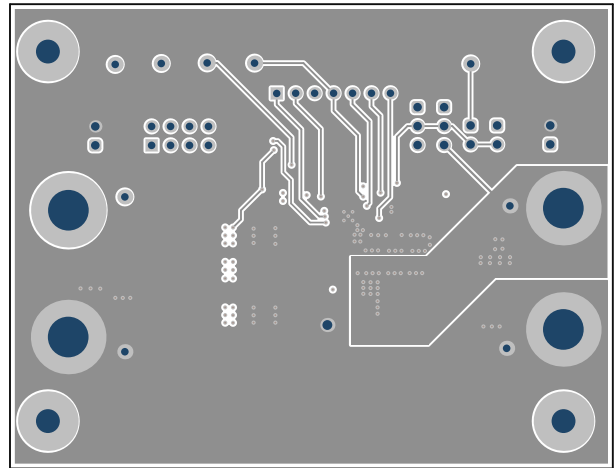

Figure 6-4. Signal Layer 2

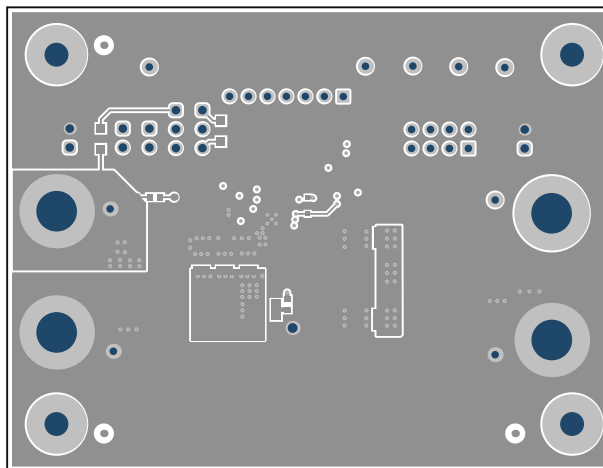

Figure 6-5. Bottom Layer

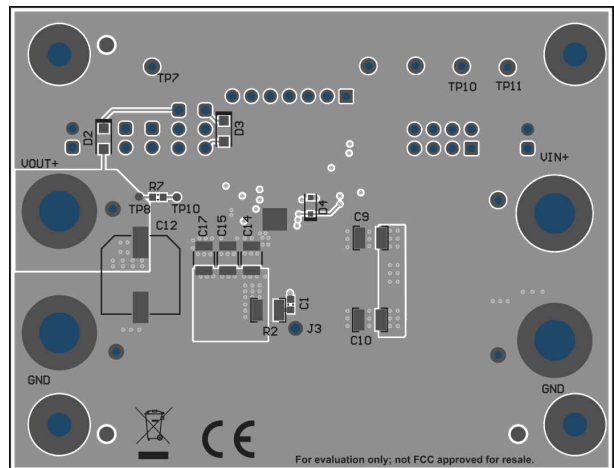

Figure 6-6. Bottom Layer and Silkscreen

## 6.1 Schematic

Figure 6-7 shows the EVM schematic.

LM5158EVM-BST  
1.2A/0.6A

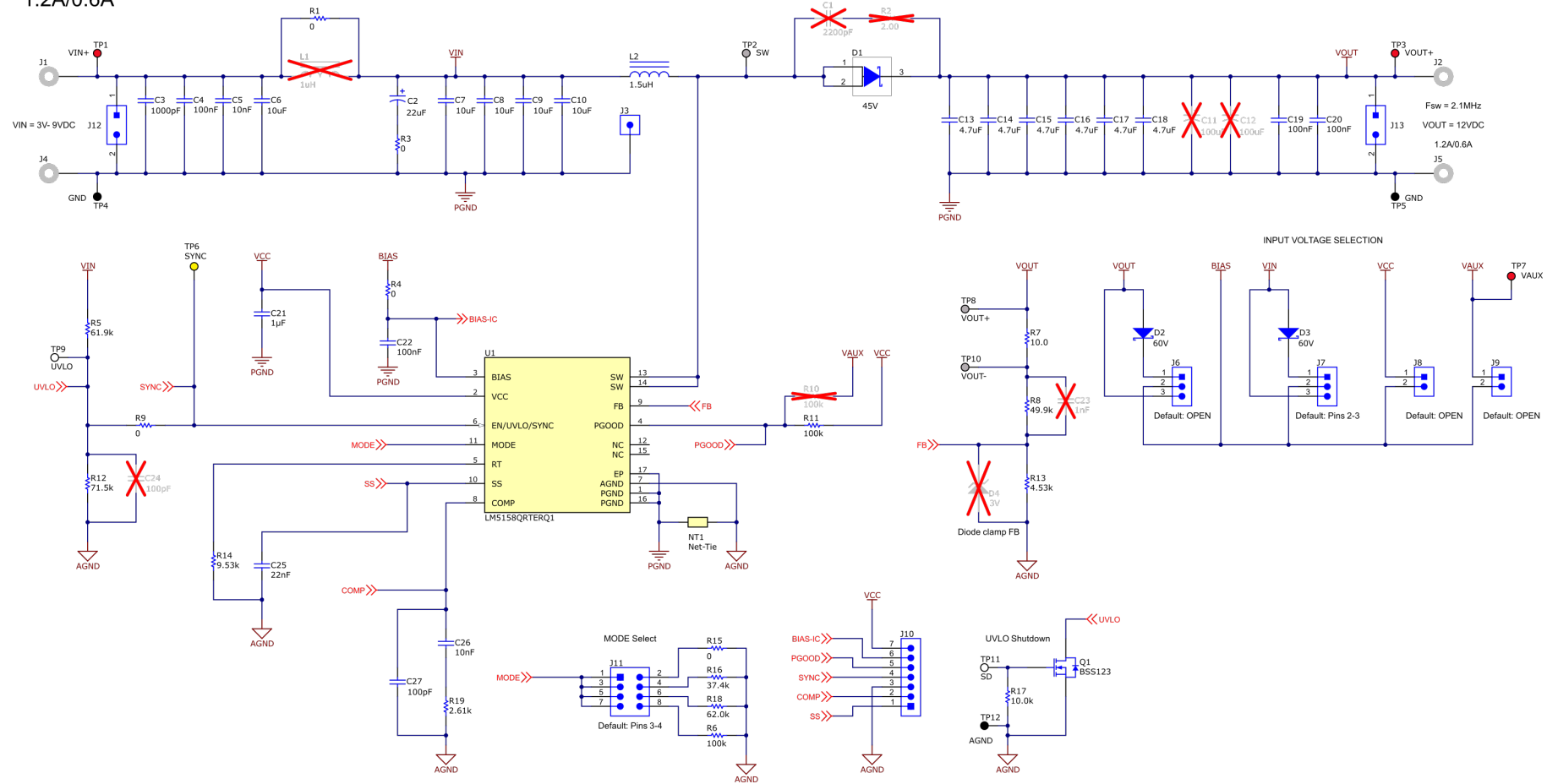

Figure 6-7. LM5158EVM-BST Schematic

## 6.2 Bill of Materials

Table 6-1 lists the EVM bill of materials.

**Table 6-1. LM5158EVM-BST Bill of Materials**

DESIGNATOR	QTY	VALUE	DESCRIPTION	PACKAGE REFERENCE	PART NUMBER	MANUFACTURER	ALTERNATE MANUFACTURER
C2	1	22 $\mu$ F	CAP, AL, 22 $\mu$ F, 100 V, $\pm$ 20%, 1.3 $\Omega$ , AEC-Q200 Grade 2, SMD	SMT Radial F	EEE-FK2A220P	Panasonic	
C3	1	1000 pF	CAP, CERM, 1000 pF, 50 V, $\pm$ 10%, X7R, 0603	0603	C0603X102K5RACTU	Kemet	
C4, C17, C18	3	0.1 $\mu$ F	CAP, CERM, 0.1 $\mu$ F, 50 V, $\pm$ 10%, X7R, AEC-Q200 Grade 1, 0603	0603	C0603C104K5RACAUTO	Kemet	
C5, C25	2	0.01 $\mu$ F	CAP, CERM, 0.01 $\mu$ F, 50 V, $\pm$ 10%, X7R, 0603	0603	C0603X103K5RACTU	Kemet	
C6, C7, C8, C9, C10	5	10 $\mu$ F	CAP, CERM, 10 $\mu$ F, 50 V, $\pm$ 10%, X7R, 1210	1210	GRM32ER71H106KA12L	MuRata	
C11, C12, C13, C14, C15, C16	6	4.7 $\mu$ F	CAP, CERM, 4.7 $\mu$ F, 50 V, $\pm$ 10%, X7R, AEC-Q200 Grade 1, 1210	1210	CGA6P3X7R1H475K250AB	TDK	
C21	1	1 $\mu$ F	CAP, CERM, 1 $\mu$ F, 16 V, $\pm$ 10%, X7R, AEC-Q200 Grade 1, 0603	0603	CGA3E1X7R1C105K080AC	TDK	
C22	1	0.1 $\mu$ F	CAP, CERM, 0.1 $\mu$ F, 100 V, $\pm$ 10%, X7R, AEC-Q200 Grade 1, 0603	0603	GCJ188R72A104KA01D	MuRata	
C24	1	0.022 $\mu$ F	CAP, CERM, 0.022 $\mu$ F, 50 V, $\pm$ 10%, X7R, 0603	0603	C0603X223K5RACTU	Kemet	
C26	1	100 pF	CAP, CERM, 100 pF, 50 V, $\pm$ 5%, C0G/NP0, AEC-Q200 Grade 0, 0603	0603	CGA3E2NP01H101J080AA	TDK	
D1	1	45 V	Diode, Schottky, 45 V, 10 A, AEC-Q101, CFP15	CFP15	PMEG045V100EPDAZ	Nexperia	
D3, D4	2	60 V	Diode, Schottky, 60 V, 1 A, SOD-123F	SOD-123F	PMEG6010CEH,115	Nexperia	
H1, H2, H3, H4	4		Machine Screw, Round, #4-40 x 1/4, Nylon, Philips panhead	Screw	NY PMS 440 0025 PH	B&F Fastener Supply	
H5, H6, H7, H8	4		Standoff, Hex, 0.5"L #4-40 Nylon	Standoff	1902C	Keystone	
J1, J2, J4, J5	4		Standard Banana Jack, Uninsulated, 8.9 mm	Keystone575-8	575-8	Keystone	
J3	1		TEST POINT SLOTTED .118", TH	Test point, TH Slot Test point	1040	Keystone	
J6, J7	2		Header, 100 mil, 3x1, Gold, TH	3x1 Header	TSW-103-07-G-S	Samtec	
J8, J9, J12, J13	2		Header, 100 mil, 2x1, Gold, TH	2x1 Header	TSW-102-07-G-S	Samtec	
J10	1		Header, 100 mil, 4x2, Gold, TH	4x2 Header	TSW-104-07-G-D	Samtec	
J11	1		Header, 100 mil, 7x1, Gold, TH	7x1 Header	TSW-107-07-G-S	Samtec	



**Table 6-1. LM5158EVM-BST Bill of Materials (continued)**

DESIGNATOR	QTY	VALUE	DESCRIPTION	PACKAGE REFERENCE	PART NUMBER	MANUFACTURER	ALTERNATE MANUFACTURER
L2	1	1.5 $\mu$ H	Inductor, Shielded, Composite, 1.5 $\mu$ H, 14 A, 0.01052 $\Omega$ , AEC-Q200 Grade 1, SMD		XEL6030-152MEB	Coilcraft	
LBL1	1		Thermal Transfer Printable Labels, 0.650" W x 0.200" H - 10,000 per roll	PCB Label 0.650 x 0.200 inch	THT-14-423-10	Brady	
Q3	1	100 V	MOSFET, N-CH, 100 V, 0.17 A, SOT-23	SOT-23	BSS123	Fairchild Semiconductor	None
R2	1	0	RES, 0, 5%, 2 W, 2512 WIDE	2512 WIDE	RCL12250000Z0EG	Vishay Draloric	
R3, R6, R8, R10	4	0	RES, 0, 5%, 0.1 W, 0603	0603	RC0603JR-070RL	Yageo	
R5, R13	2	100 k	RES, 100 k, 1%, 0.1 W, AEC-Q200 Grade 0, 0603	0603	CRCW0603100KFKEA	Vishay-Dale	
R7	1	37.4 k	RES, 37.4 k, 1%, 0.1 W, AEC-Q200 Grade 0, 0603	0603	CRCW060337K4FKEA	Vishay-Dale	
R9	1	61.9 k	RES, 61.9 k, 1%, 0.1 W, AEC-Q200 Grade 0, 0603	0603	CRCW060361K9FKEA	Vishay-Dale	
R11	1	62 k	RES, 62 k, 5%, 0.1 W, AEC-Q200 Grade 0, 0603	0603	CRCW060362K0JNEA	Vishay-Dale	
R12	1	10.0	RES, 10.0, 1%, 0.1 W, 0603	0603	RC0603FR-0710RL	Yageo	
R14	1	49.9 k	RES, 49.9 k, 1%, 0.1 W, 0603	0603	RC0603FR-0749K9L	Yageo	
R15	1	71.5 k	RES, 71.5 k, 1%, 0.1 W, AEC-Q200 Grade 0, 0603	0603	CRCW060371K5FKEA	Vishay-Dale	
R16	1	9.53 k	RES, 9.53 k, 1%, 0.1 W, AEC-Q200 Grade 0, 0603	0603	CRCW06039K53FKEA	Vishay-Dale	
R17	1	4.53 k	RES, 4.53 k, 1%, 0.1 W, AEC-Q200 Grade 0, 0603	0603	CRCW06034K53FKEA	Vishay-Dale	
R19	1	2.61 k	RES, 2.61 k, 1%, 0.1 W, 0603	0603	RC0603FR-072K61L	Yageo	
R21	1	10.0 k	RES, 10.0 k, 1%, 0.1 W, AEC-Q200 Grade 0, 0603	0603	CRCW060310K0FKEA	Vishay-Dale	
SH-J1, SH-J2	2		Single Operation 2.54 mm Pitch Open Top Jumper Socket	Single Operation 2.54mm Pitch Open Top Jumper Socket	M7582-05	Harwin	
TP1, TP3, TP7	3		Test Point, Miniature, Red, TH	Red Miniature Testpoint	5000	Keystone	
TP4, TP5, TP10	3		Test Point, Miniature, Black, TH	Black Miniature Testpoint	5001	Keystone	
TP6	1		Test Point, Miniature, Yellow, TH	Yellow Miniature Testpoint	5004	Keystone	

**Table 6-1. LM5158EVM-BST Bill of Materials (continued)**

DESIGNATOR	QTY	VALUE	DESCRIPTION	PACKAGE REFERENCE	PART NUMBER	MANUFACTURER	ALTERNATE MANUFACTURER
TP11, TP12	2		Test Point, Miniature, White, TH	White Miniature Testpoint	5002	Keystone	
U1	1		2.2MHz Wide VIN Boost/Sepic/Flyback Converter with Dual Random Spread Spectrum, RTE0016K (WQFN-16)	RTE0016K	LM5158QRTERQ1	Texas Instruments	Texas Instruments
C1	0	2200 pF	CAP, CERM, 2200 pF, 100 V, ±10%, X7R, 0603	0603	GRM188R72A222KA01D	MuRata	
C23	0	100 pF	CAP, CERM, 100 pF, 50 V, ±1%, C0G/NP0, 0603	0603	C0603C101F5GACTU	Kemet	
C28, C29	0	100 µF	CAP, Polymer Hybrid, 100 µF, 50 V, ±20%, 0.028 Ω, AEC-Q200 Grade 1, D10xL10.2mm SMD	D10xL10.2mm	EEH-ZC1H101P	Panasonic	
C36	0	0.068 µF	CAP, CERM, 0.068 µF, 50 V, ±10%, X7R, AEC-Q200 Grade 1, 0603	0603	CGA3E2X7R1H683K080AA	TDK	
D5	0	3 V	Diode, Zener, 3 V, 200 mW, SOD-323	SOD-323	MMSZ5225BS-7-F	Diodes Inc.	
FID1, FID2, FID3, FID4, FID5, FID6	0		Fiducial mark. There is nothing to buy or mount.	N/A	N/A	N/A	
L1	0	1 µH	Inductor, Shielded, Composite, 1 µH, 21.8 A, 0.00455 Ω, SMD	XAL7030	XAL7030-102MEB	Coilcraft	
R1	0	2.00	RES, 2.00, 1%, 0.5 W, AEC-Q200 Grade 0, 1210	1210	ERJ-14BQF2R0U	Panasonic	
R4	0	100 k	RES, 100 k, 1%, 0.1 W, AEC-Q200 Grade 0, 0603	0603	CRCW0603100KFKEA	Vishay-Dale	

## IMPORTANT NOTICE AND DISCLAIMER

TI PROVIDES TECHNICAL AND RELIABILITY DATA (INCLUDING DATA SHEETS), DESIGN RESOURCES (INCLUDING REFERENCE DESIGNS), APPLICATION OR OTHER DESIGN ADVICE, WEB TOOLS, SAFETY INFORMATION, AND OTHER RESOURCES "AS IS" AND WITH ALL FAULTS, AND DISCLAIMS ALL WARRANTIES, EXPRESS AND IMPLIED, INCLUDING WITHOUT LIMITATION ANY IMPLIED WARRANTIES OF MERCHANTABILITY, FITNESS FOR A PARTICULAR PURPOSE OR NON-INFRINGEMENT OF THIRD PARTY INTELLECTUAL PROPERTY RIGHTS.

These resources are intended for skilled developers designing with TI products. You are solely responsible for (1) selecting the appropriate TI products for your application, (2) designing, validating and testing your application, and (3) ensuring your application meets applicable standards, and any other safety, security, regulatory or other requirements.

These resources are subject to change without notice. TI grants you permission to use these resources only for development of an application that uses the TI products described in the resource. Other reproduction and display of these resources is prohibited. No license is granted to any other TI intellectual property right or to any third party intellectual property right. TI disclaims responsibility for, and you will fully indemnify TI and its representatives against, any claims, damages, costs, losses, and liabilities arising out of your use of these resources.

TI's products are provided subject to [TI's Terms of Sale](#) or other applicable terms available either on [ti.com](http://ti.com) or provided in conjunction with such TI products. TI's provision of these resources does not expand or otherwise alter TI's applicable warranties or warranty disclaimers for TI products.

TI objects to and rejects any additional or different terms you may have proposed.

Mailing Address: Texas Instruments, Post Office Box 655303, Dallas, Texas 75265  
Copyright © 2022, Texas Instruments Incorporated