

P/N : 46562-9330 (G-5P-30S-5P-G)

ALLOW EXTRA SPACE
4.00 MM PER SIDE
(REQUIRED FOR RE-WORK PER AS-46436-100)

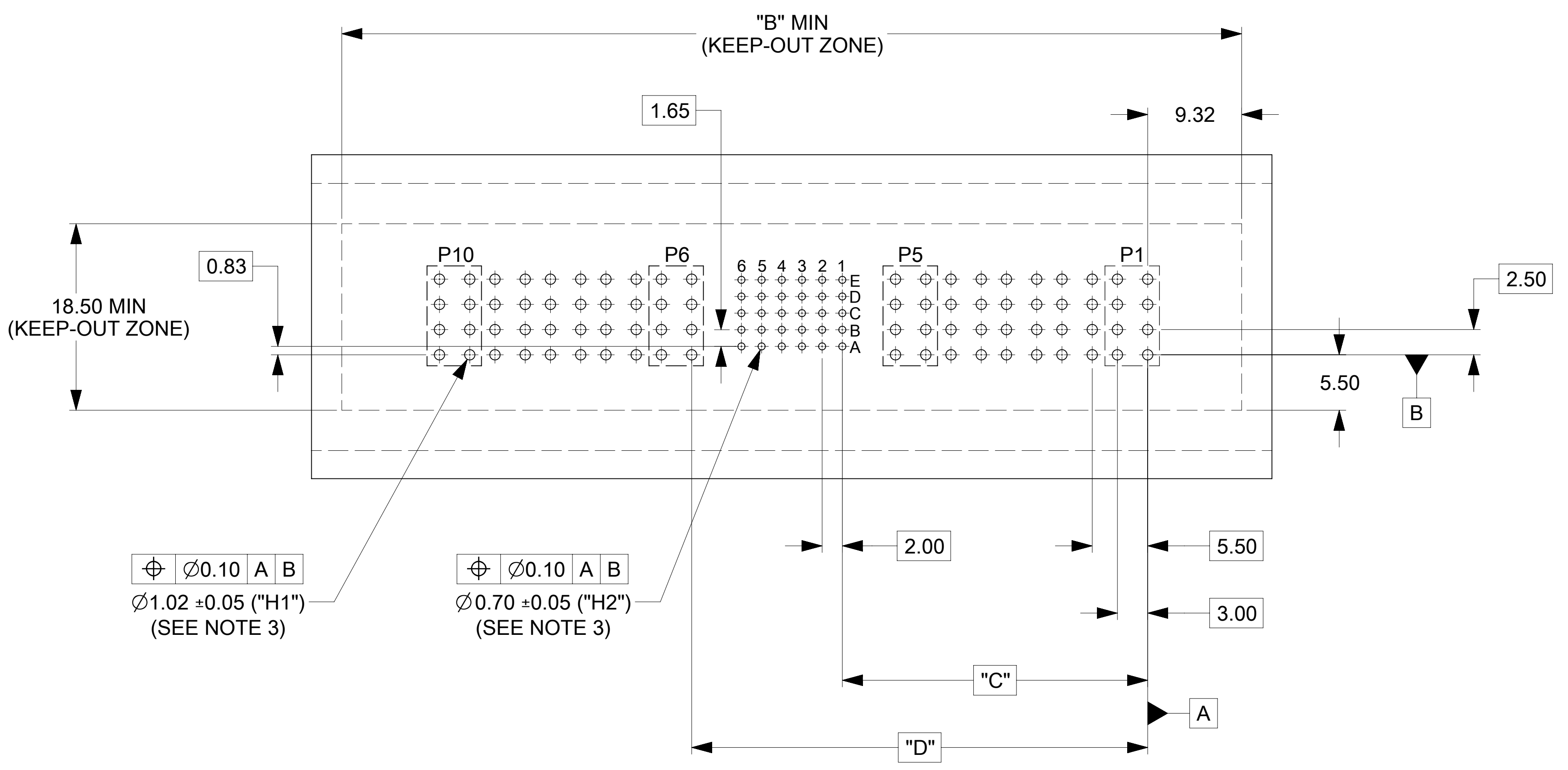
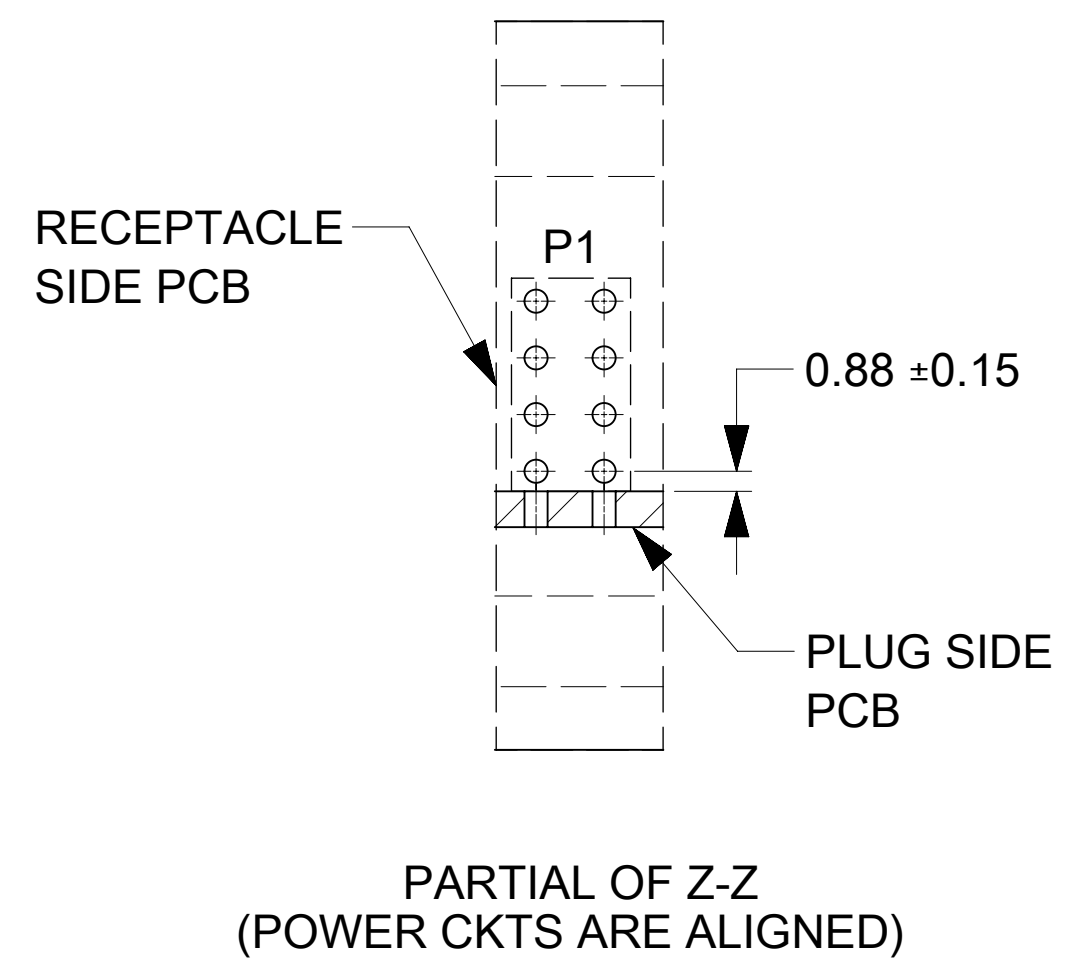
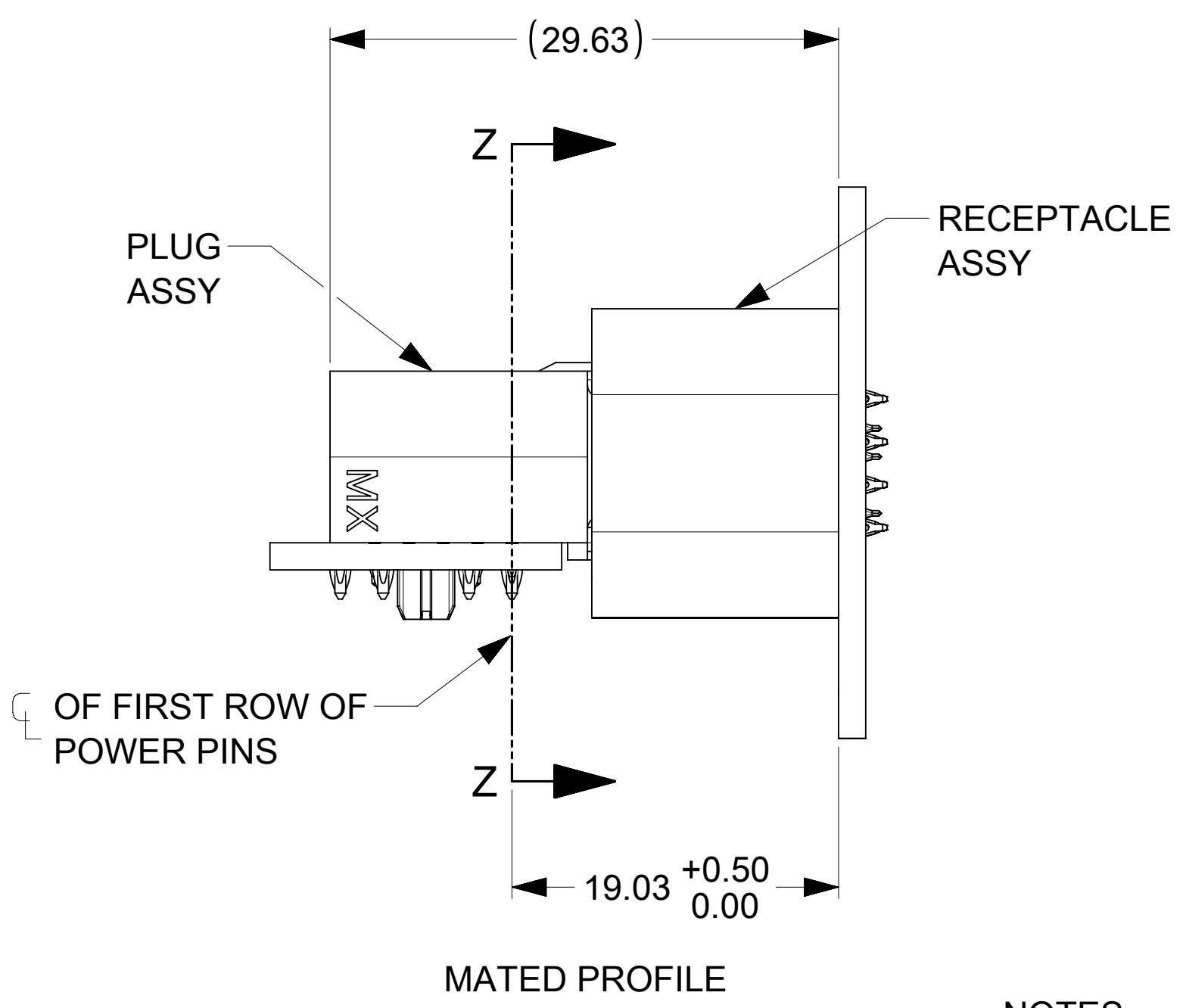
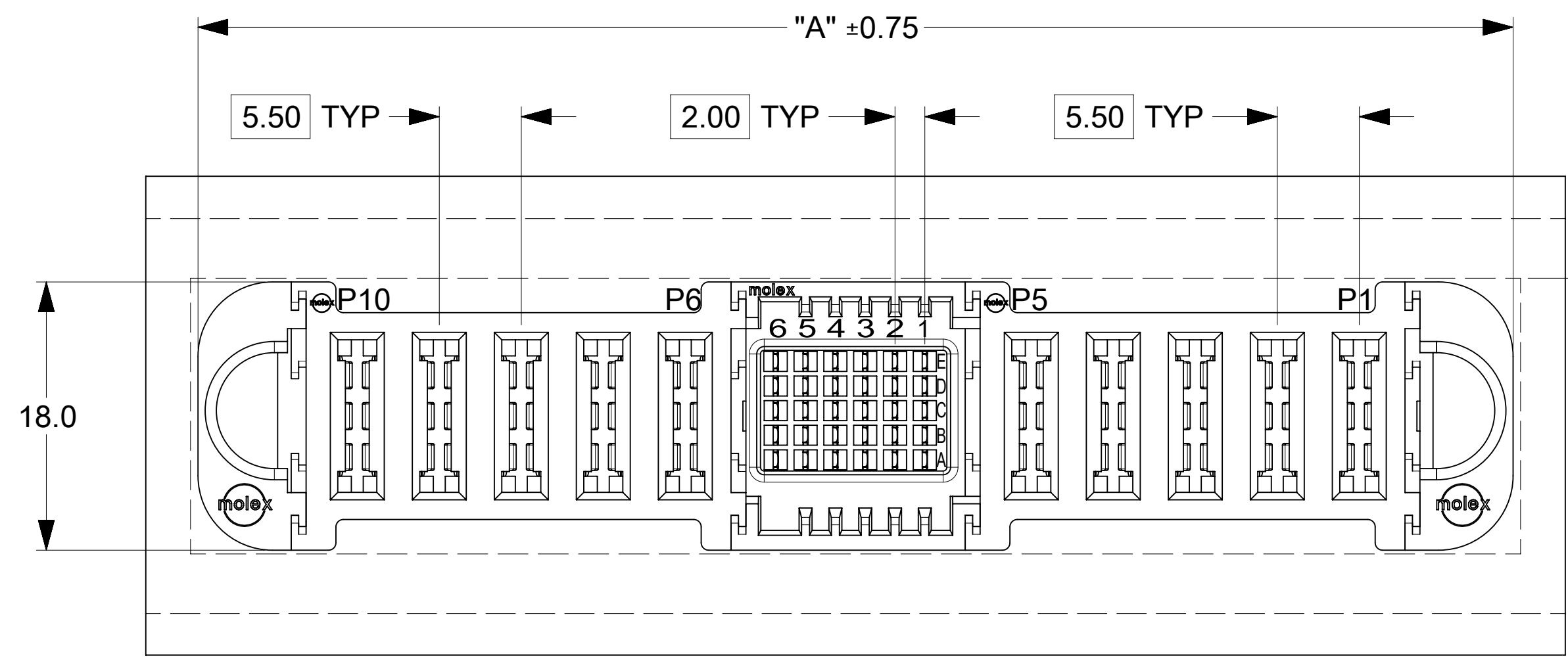

- NOTES:
- MATERIAL:
 - HOUSINGS: LCP UL94, V-0, COLOR: BLACK
 - TERMINALS: HIGH CONDUCTIVITY COPPER ALLOY
 - PLATING: 1.27 MICROMETER (50 MICROINCH) NICKEL OVERALL WITH 2.54 MICROMETER (100 MICROINCH) SELECTIVE TIN ON TAILS AND 0.762 MICROMETER (30 MICROINCH) SELECTIVE GOLD ON CONTACT AREA
 - PACKAGING: ASSEMBLIES TO BE TRAY PACKED PER PACKAGING SPEC: 465621001-PK
 - PLATED THRU HOLE SIZE, REFER TO PS-46436-100 FOR DETAILS
 - PRODUCT SPEC: PS-46436-100
 - APPLICATION SPEC: AS-46436-100
 - PRODUCT TO MEET RoHS REQUIREMENTS
 - ASSEMBLY MATES TO MOLEX PLUG ASSEMBLY P/N 46437-**** (SEE TABLE IN SHEET 2)
 - TAIL DESIGN: COMPLIANT PINS
 - POWER AND SIGNAL CONTACTS ARE LUBRICATED.
 - MOLEX LOGO TO BE LOCATED APPROXIMATELY AS SHOWN.

RECOMMENDED PCB LAYOUT AND KEEP-OUT ZONE FOR G-(1P TO 5P)-30S-(1P TO 5P)-G

THIS DRAWING CONTAINS INFORMATION THAT IS PROPRIETARY TO MOLEX ELECTRONIC TECHNOLOGIES, LLC AND SHOULD NOT BE USED WITHOUT WRITTEN PERMISSION									
DIMENSION UNITS	SCALE	CURRENT REV DESC: ADDED ISOMETRIC VIEWS							
mm	3:1								
GENERAL TOLERANCES (UNLESS SPECIFIED)									
ANGULAR TOL	± 0.5°								
4 PLACES	±	EC NO: 689821							
3 PLACES	±	DRWN: HARSHG 2021/12/13							
2 PLACES	± 0.13	CHK'D: GJEEVANSURES 2021/12/22							
1 PLACE	± 0.25	APPR: HTHYAGARAJ 2022/02/14							
0 PLACES	±	INITIAL REVISION:							
DRAFT WHERE APPLICABLE MUST REMAIN WITHIN DIMENSIONS		THIRD ANGLE PROJECTION		DRAWING		SERIES		MATERIAL NUMBER	
		D-SIZE		46562		SEE TABLE		CUSTOMER	
				GENERAL MARKET				SHEET NUMBER	
								1 OF 4	

DOCUMENT STATUS	P1	RELEASE DATE	2022/02/14	09:02:13
-----------------	----	--------------	------------	----------

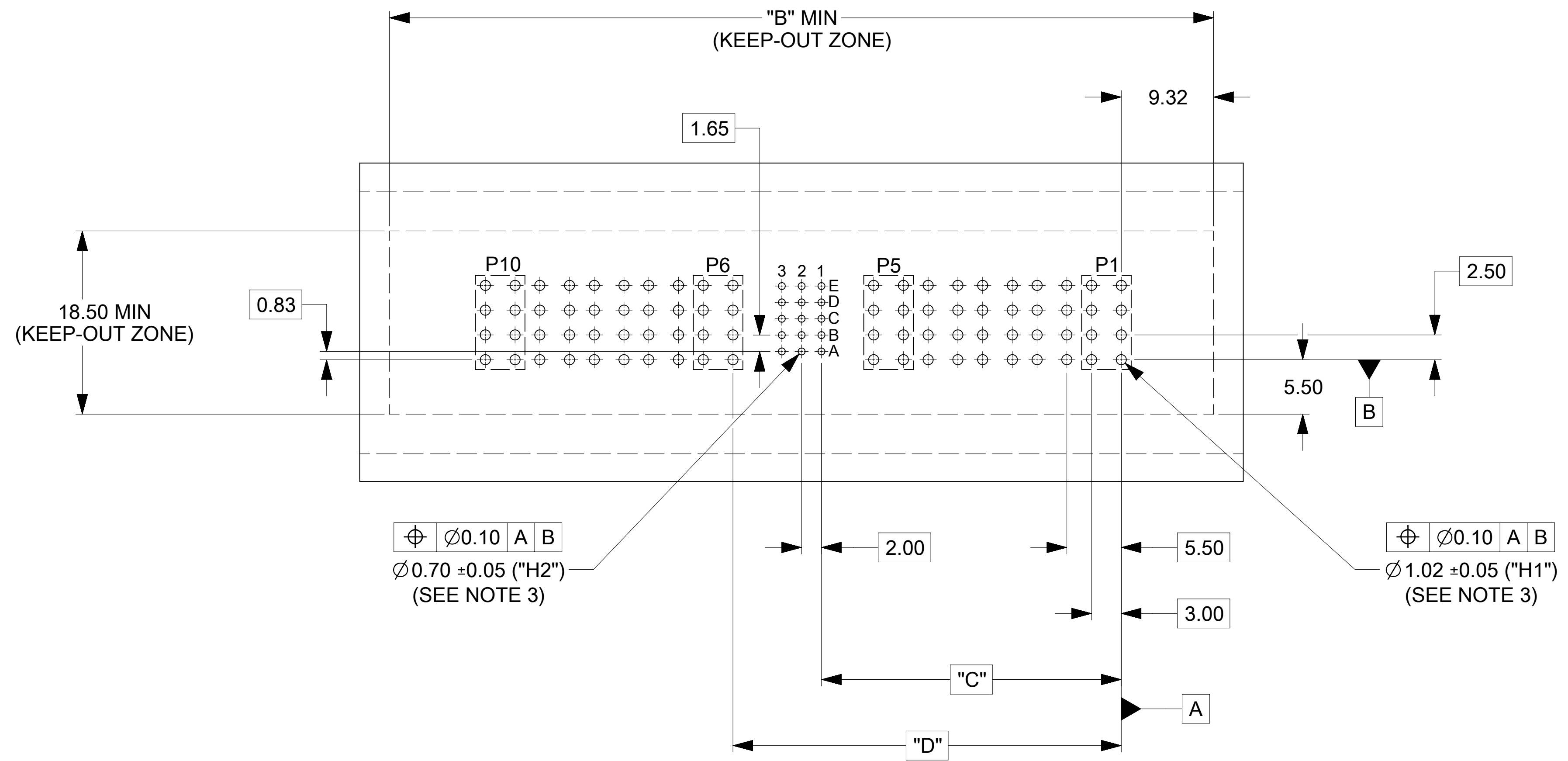

RECOMMENDED PCB LAYOUT AND KEEP-OUT ZONE FOR G-(1P TO 5P)-15S-(1P TO 5P)-G

REFER TO BELOW TABLE FOR DIMENSIONS.

FG P/N	CONFIGURATION	POWER CKT SIZE	SIGNAL CKT SIZE	DIM "A" (IN MM)	DIM "B" (IN MM)	DIM "C" (IN MM)	DIM "D" (IN MM)	HOLES COUNT "H1"	HOLES COUNT "H2"	MATES WITH R/A PLUG ASSY P/N
465629321	G-1P-15S-1P-G	1	15	38.21	39.21	8.28	17.21	16	15	464379321
465629322	G-2P-15S-2P-G	2	15	49.21	50.21	13.78	22.71	32	15	464379322
465629323	G-3P-15S-3P-G	3	15	60.21	61.21	19.28	28.21	48	15	464379323
465629324	G-4P-15S-4P-G	4	15	71.21	72.21	24.78	33.71	64	15	464379324
465629325	G-5P-15S-5P-G	5	15	82.21	83.21	30.28	39.21	80	15	464379325
465629326	G-1P-30S-1P-G	1	30	44.21	45.21	8.28	23.21	16	30	464379326
465629327	G-2P-30S-2P-G	2	30	55.21	56.21	13.78	28.71	32	30	464379327
465629328	G-3P-30S-3P-G	3	30	66.21	67.21	19.28	34.21	48	30	464379328
465629329	G-4P-30S-4P-G	4	30	77.21	78.21	24.78	39.71	64	30	464379329
465629330	G-5P-30S-5P-G	5	30	88.21	89.21	30.28	45.21	80	30	464379330

THIS DRAWING CONTAINS INFORMATION THAT IS PROPRIETARY TO MOLEX ELECTRONIC TECHNOLOGIES, LLC AND SHOULD NOT BE USED WITHOUT WRITTEN PERMISSION

DIMENSION UNITS mm	SCALE 3:1	CURRENT REV DESC: ADDED ISOMETRIC VIEWS	
GENERAL TOLERANCES (UNLESS SPECIFIED)		EC NO: 689821	
ANGULAR TOL	± 0.5°	DRWN: HARSHG	2021/12/13
4 PLACES	±	CHK'D: GJEEVANSURES	2021/12/22
3 PLACES	±	APPR: HTHYAGARAJ	2022/02/14
2 PLACES	± 0.13	INITIAL REVISION:	
1 PLACE	± 0.25	DRWN: KSUTAR	2021/08/17
0 PLACES	±	APPR: HTHYAGARAJ	2021/10/21
DRAFT WHERE APPLICABLE MUST REMAIN WITHIN DIMENSIONS		THIRD ANGLE PROJECTION	DRAWING
		D-SIZE	SERIES 46562
		MATERIAL NUMBER	CUSTOMER
		SEE TABLE	GENERAL MARKET
		DOCUMENT NUMBER	DOC TYPE DOC PART REVISION
		465629330	PSD 000 A1
		SHEET NUMBER	
			2 OF 4

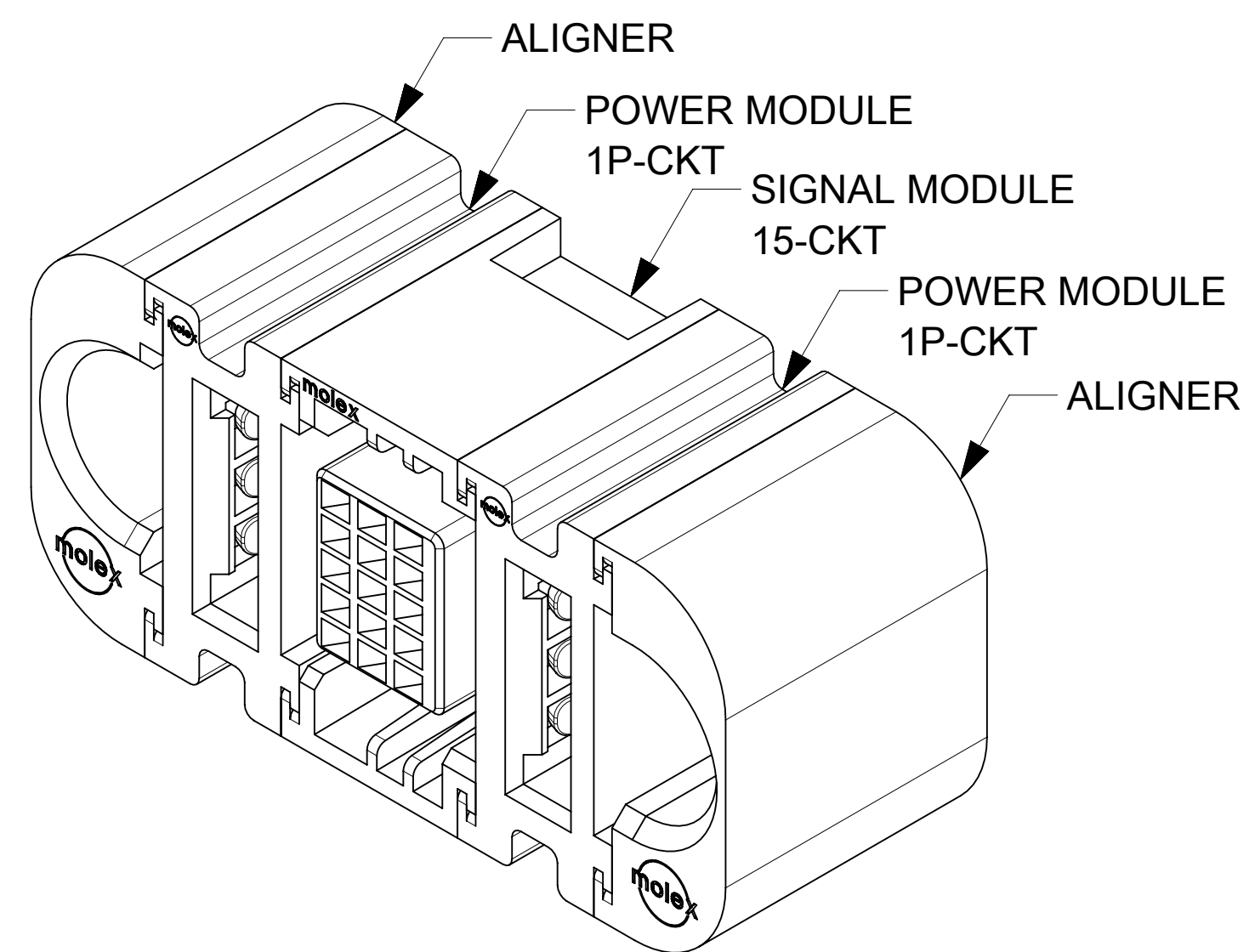

P/N : 46562-9321 (G-1P-15S-1P-G)

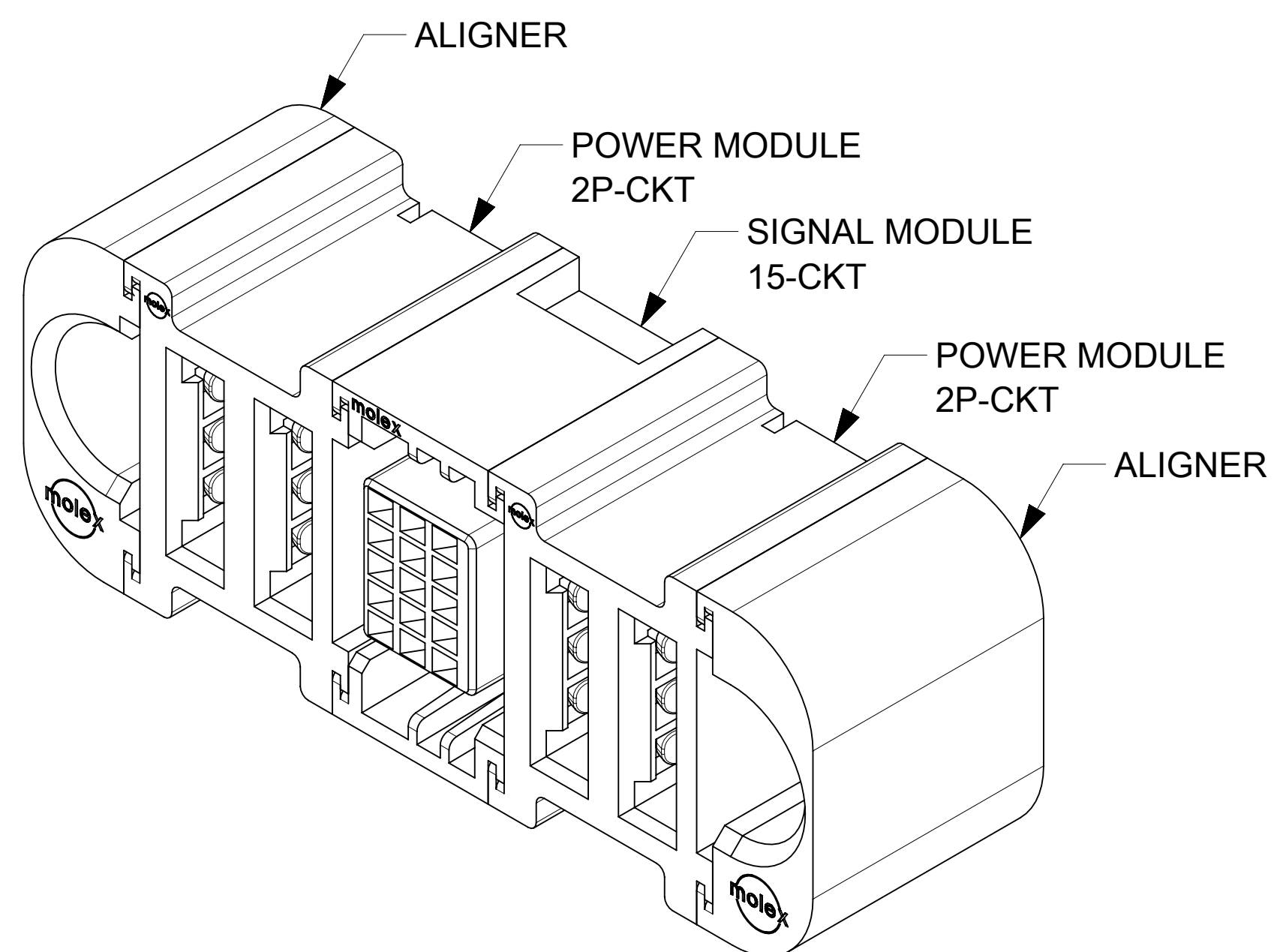

P/N : 46562-9322 (G-2P-15S-2P-G)

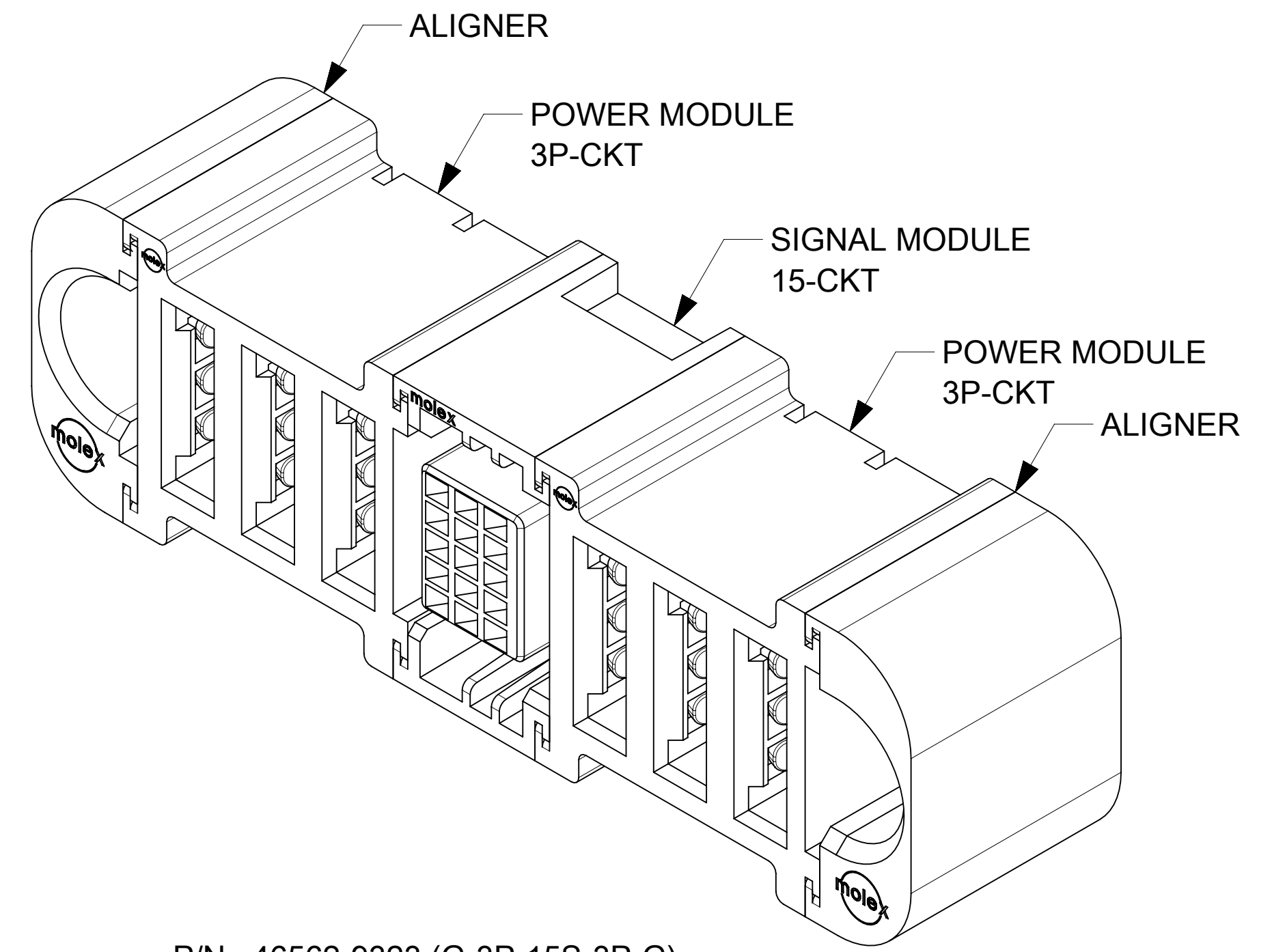

P/N : 46562-9323 (G-3P-15S-3P-G)

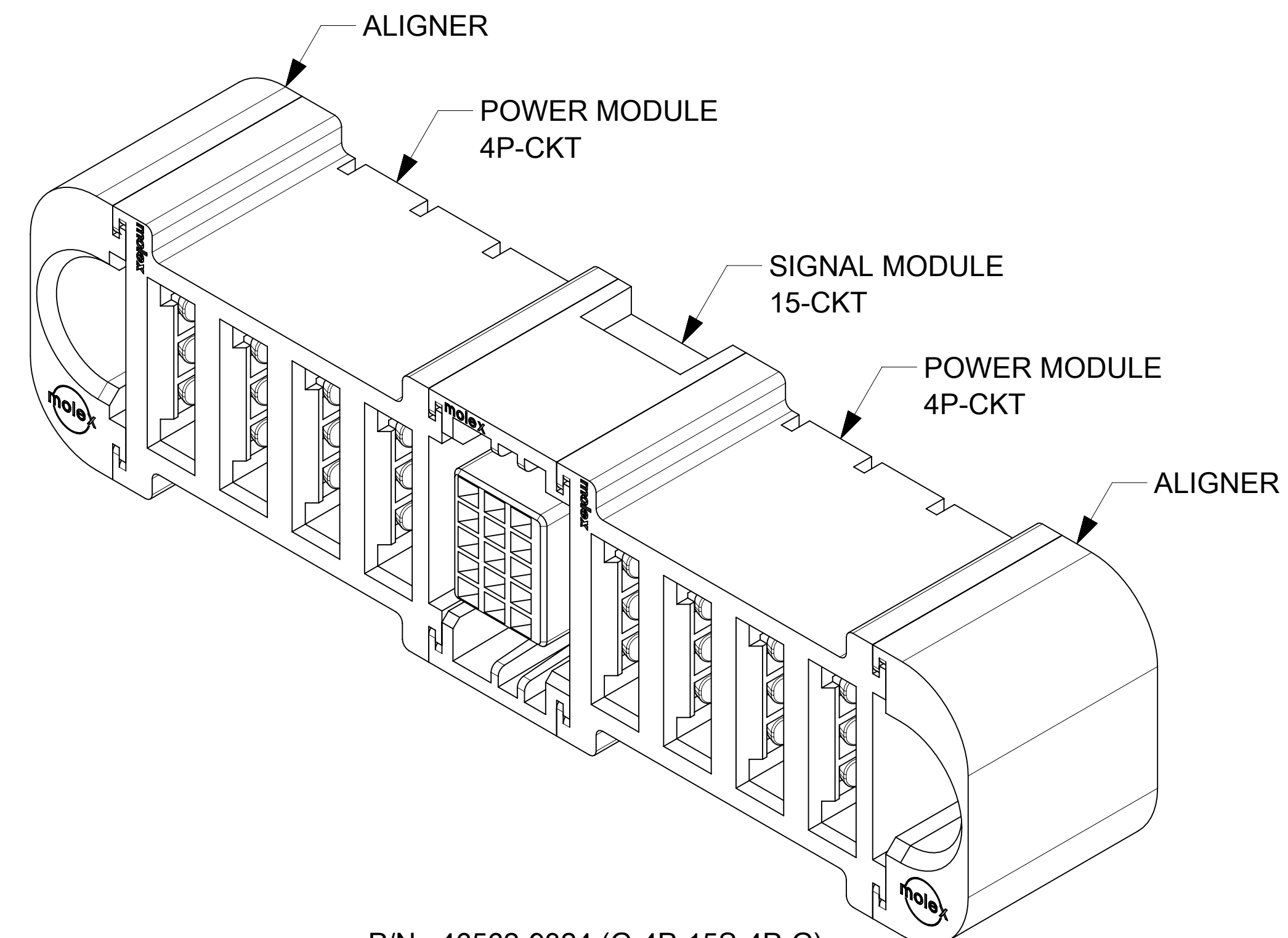

P/N : 46562-9324 (G-4P-15S-4P-G)

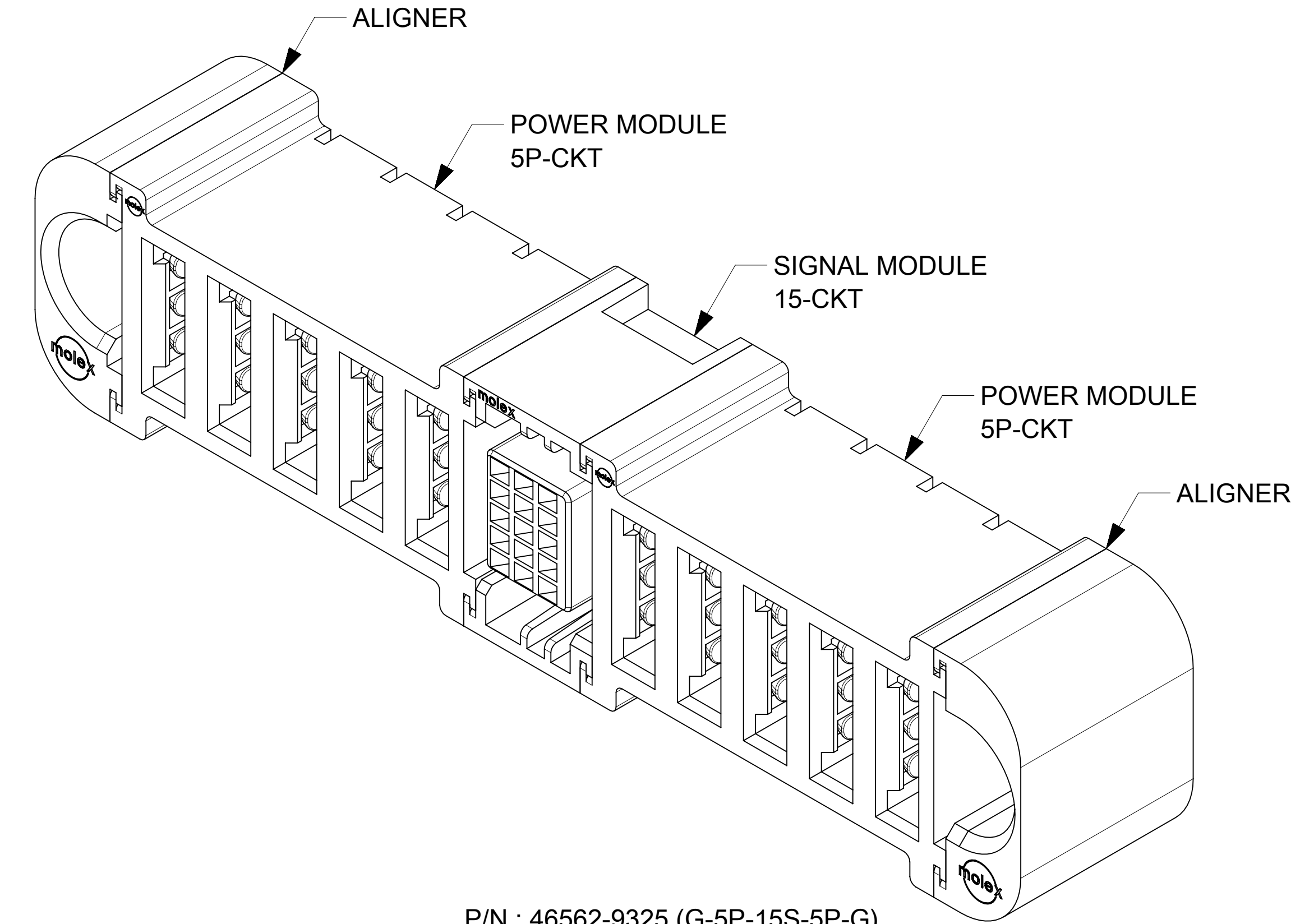

P/N : 46562-9325 (G-5P-15S-5P-G)

THIS DRAWING CONTAINS INFORMATION THAT IS PROPRIETARY TO MOLEX ELECTRONIC TECHNOLOGIES, LLC AND SHOULD NOT BE USED WITHOUT WRITTEN PERMISSION											
DIMENSION UNITS		SCALE		CURRENT REV DESC: ADDED ISOMETRIC VIEWS							
mm		4:1									
GENERAL TOLERANCES (UNLESS SPECIFIED)											
ANGULAR TOL ± 0.5°											
4 PLACES ±		EC NO: 689821									
3 PLACES ±		DRWN: HARSHG 2021/12/13									
2 PLACES ± 0.13		CHK'D: GJEEVANSURES 2021/12/22									
1 PLACE ± 0.25		APPR: HTHYAGARAJ 2022/02/14									
0 PLACES ±		INITIAL REVISION:									
DRAFT WHERE APPLICABLE		DRWN: KSUTAR 2021/08/17									
MUST REMAIN WITHIN DIMENSIONS		APPR: HTHYAGARAJ 2021/10/21									
THIRD ANGLE PROJECTION		DRAWING		SERIES		MATERIAL NUMBER		CUSTOMER		SHEET NUMBER	
D		D-SIZE		46562		SEE TABLE		GENERAL MARKET		3 OF 4	

molex

G-*P-*S-*P-G
VERT RECEPTACLE ASSY - TEN60 POWER FAMILY

PRODUCT CUSTOMER DRAWING

DOCUMENT NUMBER	DOC TYPE	DOC PART	REVISION
465629330	PSD	000	A1

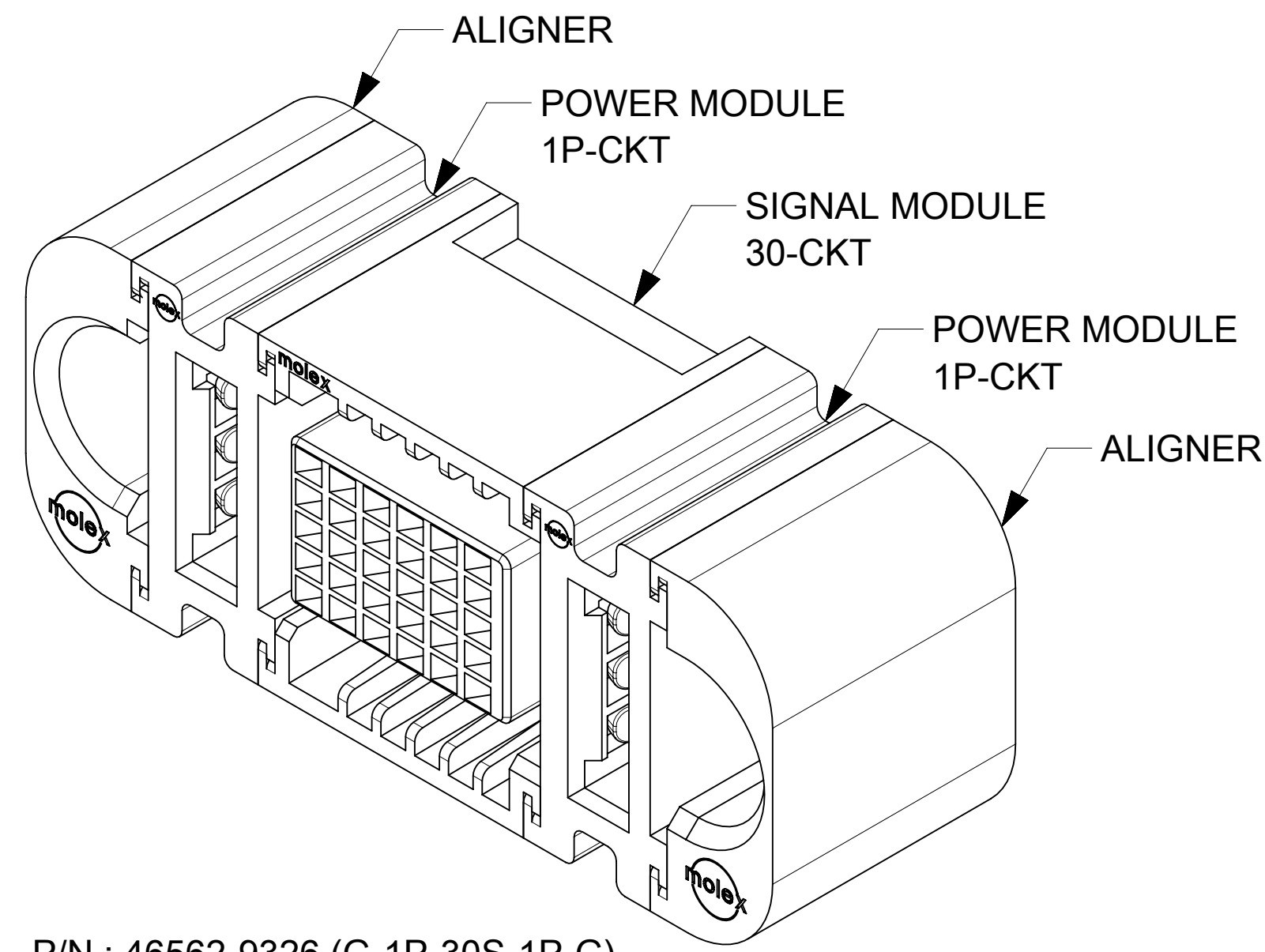

P/N : 46562-9326 (G-1P-30S-1P-G)

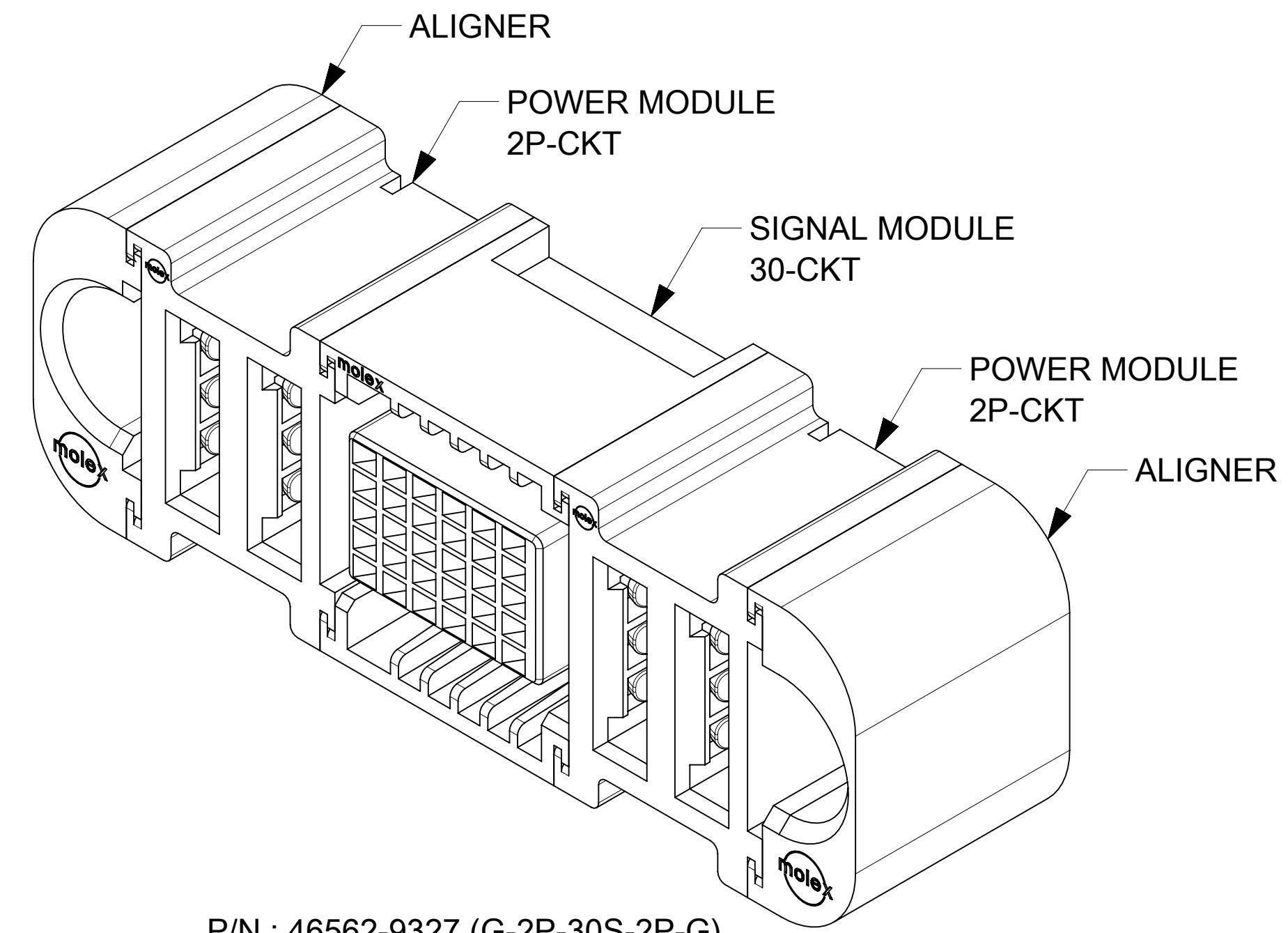

P/N : 46562-9327 (G-2P-30S-2P-G)

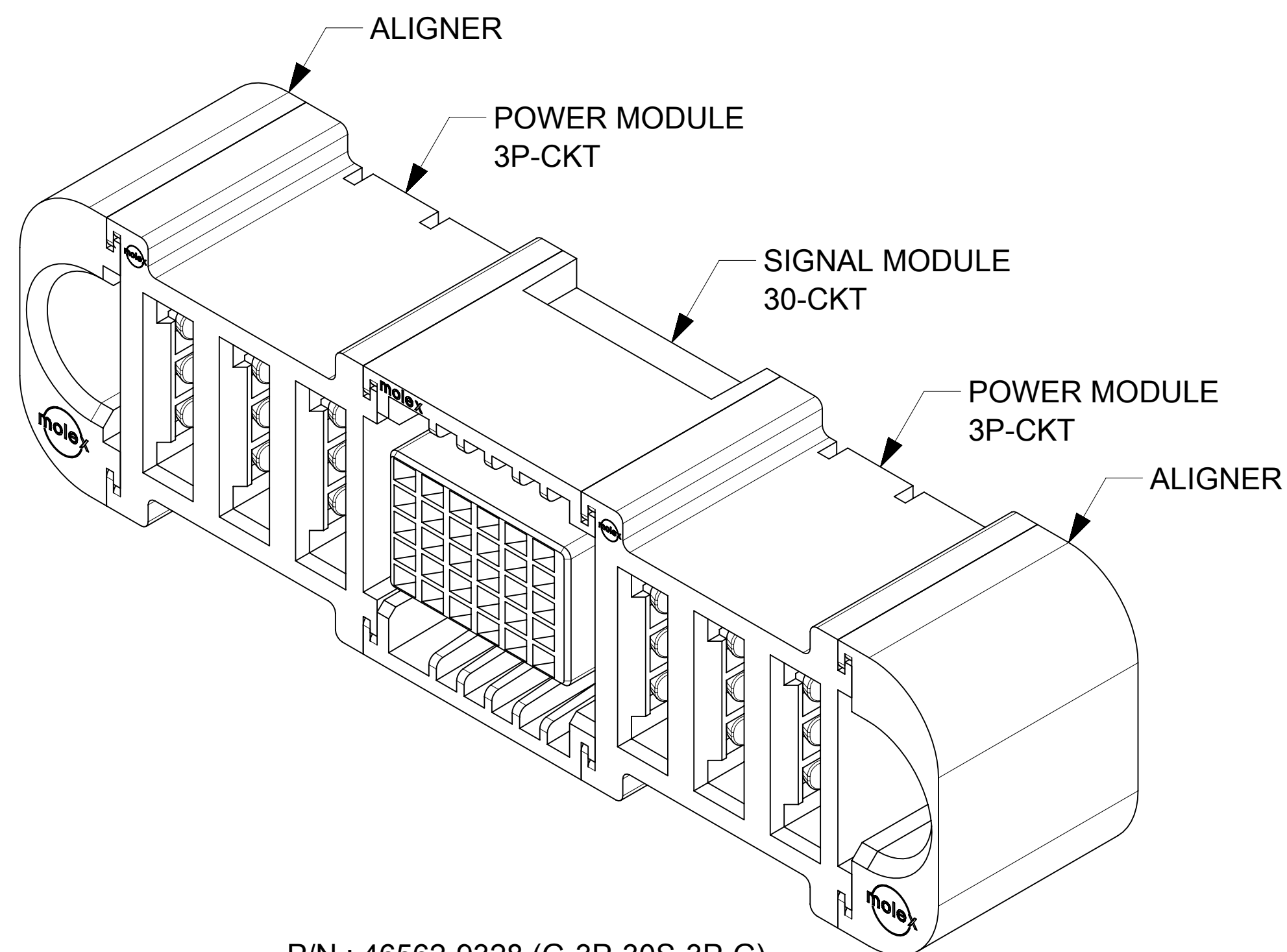

P/N : 46562-9328 (G-3P-30S-3P-G)

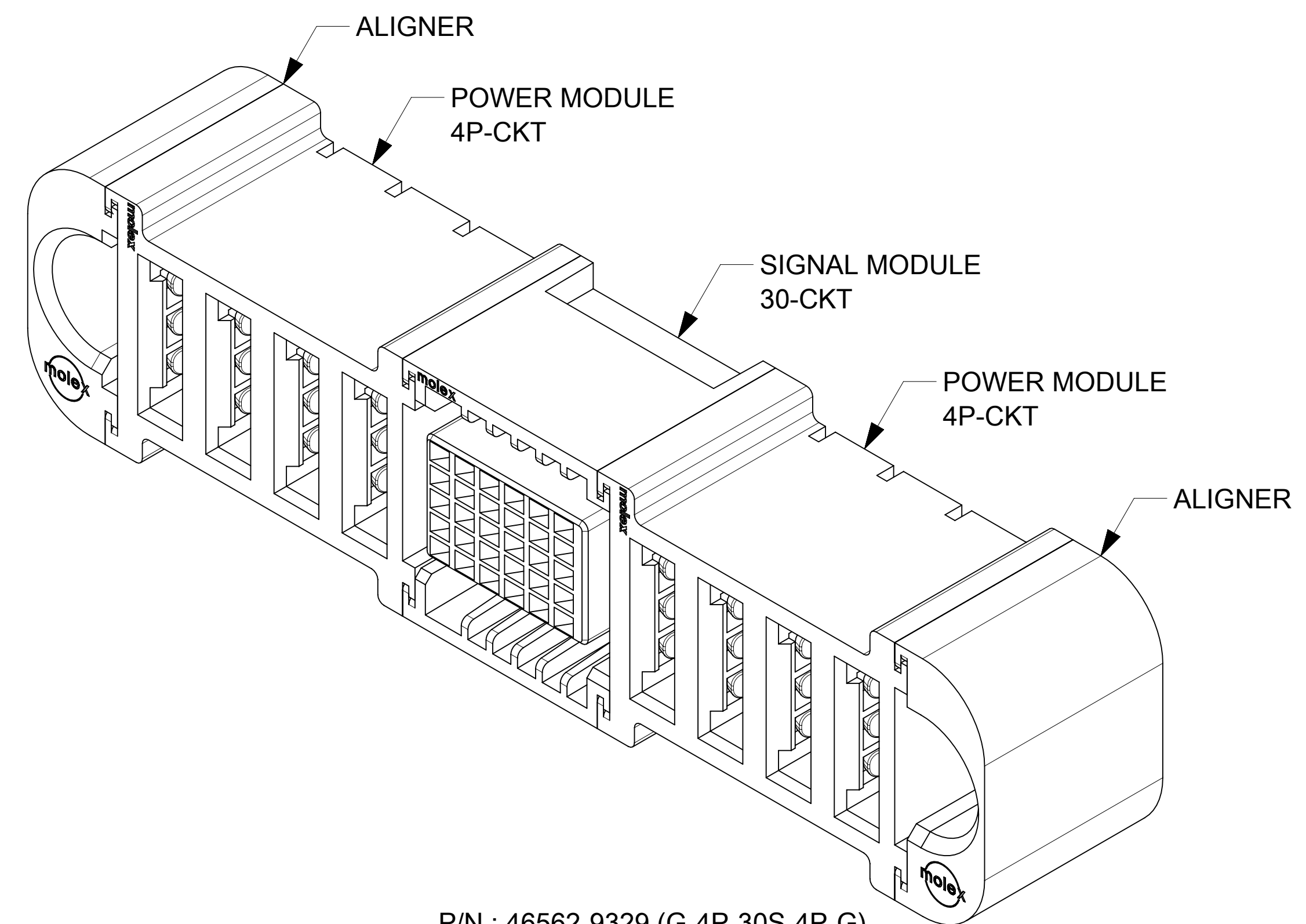

P/N : 46562-9329 (G-4P-30S-4P-G)

THIS DRAWING CONTAINS INFORMATION THAT IS PROPRIETARY TO MOLEX ELECTRONIC TECHNOLOGIES, LLC AND SHOULD NOT BE USED WITHOUT WRITTEN PERMISSION												
DIMENSION UNITS		SCALE		CURRENT REV DESC: ADDED ISOMETRIC VIEWS								
mm		4:1										
GENERAL TOLERANCES (UNLESS SPECIFIED)				EC NO: 689821		2021/12/13		G-*P-*S-*P-G VERT RECEPTACLE ASSY - TEN60 POWER FAMILY				
ANGULAR TOL ± 0.5°				DRWN: HARSHG		2021/12/22						
4 PLACES ±				CHK'D: GJEEVANSURES		2022/02/14		PRODUCT CUSTOMER DRAWING				
3 PLACES ±				APPR: HTHYAGARAJ				DOCUMENT NUMBER		DOC TYPE	DOC PART	REVISION
2 PLACES ± 0.13				INITIAL REVISION:				465629330		PSD	000	A1
1 PLACE ± 0.25				DRWN: KSUTAR		2021/08/17		MATERIAL NUMBER		CUSTOMER		SHEET NUMBER
0 PLACES ±				APPR: HTHYAGARAJ		2021/10/21		SEE TABLE		GENERAL MARKET		4 OF 4
DRAFT WHERE APPLICABLE MUST REMAIN WITHIN DIMENSIONS				THIRD ANGLE PROJECTION		DRAWING		SERIES				
						D-SIZE		46562				