

MAX4372T/F/H

Low-Cost, UCSP/SOT23, Micropower, High-Side Current-Sense Amplifier with Voltage Output

General Description

The MAX4372 low-cost, precision, high-side current-sense amplifier is available in a tiny, space-saving SOT23 5-pin package. Offered in three gain versions (T = 20V/V, F = 50V/V, and H = 100V/V), this device operates from a single 2.7V to 28V supply and consumes only 30µA. It features a voltage output that eliminates the need for gain-setting resistors and is ideal for today's notebook computers, cell phones, and other systems where battery/DC current monitoring is critical.

High-side current monitoring is especially useful in battery-powered systems since it does not interfere with the ground path of the battery charger. The input common-mode range of 0 to 28V is independent of the supply voltage and ensures that the current-sense feedback remains viable even when connected to a 2-cell battery pack in deep discharge.

The user can set the full-scale current reading by choosing the device (T, F, or H) with the desired voltage gain and selecting the appropriate external sense resistor. This capability offers a high level of integration and flexibility, resulting in a simple and compact current-sense solution. For higher bandwidth applications, refer to the MAX4173T/F/H data sheet.

Applications

- Power-Management Systems
- General-System/Board-Level Current Monitoring
- Notebook Computers
- Portable/Battery-Powered Systems
- Smart-Battery Packs/Chargers
- Cell Phones
- Precision-Current Sources

Pin Configurations

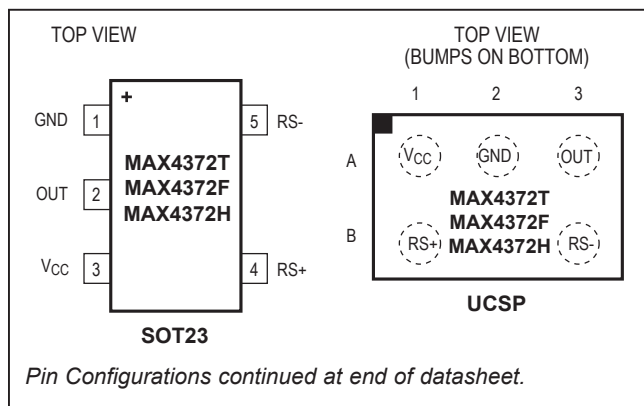

Features

- Low-Cost, Compact Current-Sense Solution
- 30µA Supply Current
- 2.7V to 28V Operating Supply
- 0.18% Full-Scale Accuracy
- 0.3mV Input Offset Voltage
- Low 1.5Ω Output Impedance
- Three Gain Versions Available
 - 20V/V (MAX4372T)
 - 50V/V (MAX4372F)
 - 100V/V (MAX4372H)
- High Accuracy +2V to +28V Common-Mode Range, Functional Down to 0V, Independent of Supply Voltage
- Available in a Space-Saving 5-Pin SOT23 Package and 3 x 2 UCSP™ (1mm x 1.5mm) Package

Ordering Information

PART	TEMP RANGE	PIN-PACKAGE	TOP MARK
MAX4372TEUK+T	-40°C to +85°C	5 SOT23	ADIU
MAX4372TESA+	-40°C to +85°C	8 SO	—
MAX4372TEBT+T	-40°C to +85°C	3 x 2 UCSP	ACX

+Denotes lead(Pb)-free/RoHS-compliant package.

T = Tape and reel.

*Note: Gain values are as follows: 20V/V for the T version, 50V/V for the F version, and 100V/V for the H version.

Ordering Information appears at end of data sheet.

Typical Operating Circuit

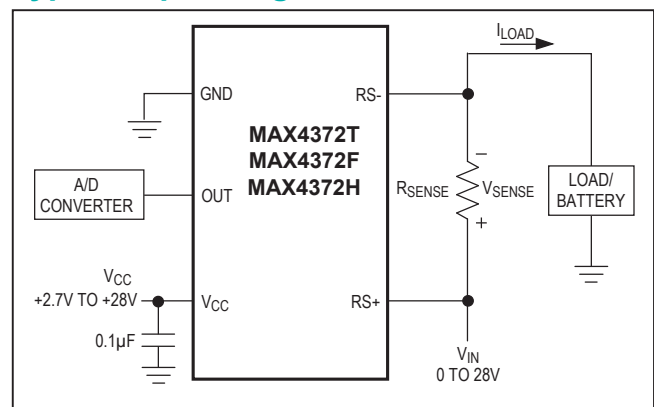

UCSP is a trademark of Maxim Integrated Products, Inc.



Absolute Maximum Ratings

V _{CC} , RS+, RS- to GND.....	-0.3V to +30V	Operating Temperature Range.....	-40°C to +85°C
OUT to GND.....	-0.3V to +15V	Storage Temperature Range.....	-65°C to +150°C
Differential Input Voltage (V _{RS+} - V _{RS-}).....	±0.3V	Lead Temperature (soldering, 10s).....	+300°C
Current into Any Pin.....	±10mA	Soldering Temperature (reflow).....	+260°C
Continuous Power Dissipation (T _A = +70°C)			
5-Pin SOT23 (derate 3.9mW/°C above +70°C).....	312.6mW		
8-Pin SO (derate 7.4mW/°C above +70°C).....	588.2mW		
3 x 2 UCSP (derate 3.4mW/°C above +70°C).....	273.2mW		

Stresses beyond those listed under "Absolute Maximum Ratings" may cause permanent damage to the device. These are stress ratings only, and functional operation of the device at these or any other conditions beyond those indicated in the operational sections of the specifications is not implied. Exposure to absolute maximum rating conditions for extended periods may affect device reliability.

Electrical Characteristics

(V_{RS+} = 0 to 28V, V_{CC} = 2.7V to 28V, V_{SENSE} = 0V, R_{LOAD} = 1MΩ, T_A = T_{MIN} to T_{MAX}, unless otherwise noted. Typical values are at T_A = +25°C.) (Note 1)

PARAMETER	SYMBOL	CONDITIONS	MIN	TYP	MAX	UNITS	
Operating Voltage Range (Note 2)	V _{CC}		2.7		28	V	
Common-Mode Input Range (Note 3)	V _{CMR}		0		28	V	
Common-Mode Rejection	CMR	V _{RS+} > 2V		85		dB	
Supply Current	I _{CC}	V _{RS+} > 2V, V _{SENSE} = 5mV		30	60	μA	
Leakage Current	I _{RS+} , I _{RS-}	V _{CC} = 0V, V _{RS+} = 28V		0.05	1.2	μA	
Input Bias Current	I _{RS+}	V _{RS+} > 2V	0		1	μA	
		V _{RS+} ≤ 2V	-25		+2		
	I _{RS-}	V _{RS+} > 2V	0		2		
		V _{RS+} ≤ 2V	-50		+2		
Full-Scale Sense Voltage (Note 4)	V _{SENSE}	Gain = 20V/V or 50V/V		150		mV	
		Gain = 100V/V		100			
Input Offset Voltage (Note 5)	V _{OS}	T _A = +25°C V _{CC} = V _{RS+} = 12V	MAX4372_ESA	0.3		±0.8	mV
			MAX4372_EUK, _EBT	0.3		±1.3	
		T _A = T _{MIN} to T _{MAX} V _{CC} = V _{RS+} = 12V	MAX4372_ESA			±1.1	
			MAX4372_EUK, _EBT			±1.9	
Full-Scale Accuracy (Note 5)		V _{SENSE} = 100mV, V _{CC} = 12V, V _{RS+} = 12V, T _A = +25°C (Note 7)		±0.18	±3		
Total OUT Voltage Error (Note 6)		V _{SENSE} = 100mV, V _{CC} = 12V, V _{RS+} = 12V (Note 7)			±6	%	
		V _{SENSE} = 100mV, V _{CC} = 28V, V _{RS+} = 28V (Note 7)		±0.15	±7		
		V _{SENSE} = 100mV, V _{CC} = 12V, V _{RS+} = 0.1V (Note 7)		±1	±28		
		V _{SENSE} = 6.25mV, V _{CC} = 12V, V _{RS+} = 12V (Note 8)		±0.15			

Electrical Characteristics (continued)

($V_{RS+} = 0$ to 28V, $V_{CC} = 2.7V$ to 28V, $V_{SENSE} = 0V$, $R_{LOAD} = 1M\Omega$, $T_A = T_{MIN}$ to T_{MAX} , unless otherwise noted. Typical values are at $T_A = +25^\circ C$.) (Note 1)

PARAMETER	SYMBOL	CONDITIONS		MIN	TYP	MAX	UNITS
OUT Low Voltage (MAX4372T, MAX4372F)	V_{OL}	$V_{CC} = 2.7V$, $V_{SENSE} = -10mV$, $V_{RS+} = 28V$	$I_{OUT} = 10\mu A$		2.6		mV
			$I_{OUT} = 100\mu A$		9	65	
OUT Low Voltage (MAX4372H)	V_{OL}	$V_{CC} = 2.7V$, $V_{SENSE} = -10mV$, $V_{RS+} = 12V$	$I_{OUT} = 10\mu A$		2.6		mV
			$I_{OUT} = 100\mu A$		9	65	
OUT High Voltage	$V_{CC} - V_{OH}$	$V_{CC} = 2.7V$, $I_{OUT} = -500\mu A$, $V_{SENSE} = 250mV$, $V_{RS+} = 28V$			0.1	0.25	V
-3dB Bandwidth	BW	$V_{RS+} = 12V$, $V_{CC} = 12V$, $C_{LOAD} = 10pF$	$V_{SENSE} = 20mV$, gain = 20V/V		275		kHz
			$V_{SENSE} = 20mV$, gain = 50V/V		200		
			$V_{SENSE} = 20mV$, gain = 100V/V		110		
			$V_{SENSE} = 6.25mV$		50		
Gain		MAX4372T			20		V/V
		MAX4372F			50		
		MAX4372H			100		
Gain Accuracy		$V_{SENSE} = 20mV$ to 100mV, $V_{RS+} = 12V$	$T_A = +25^\circ C$		± 0.25	± 2.5	%
			$T_A = -40^\circ C$ to $+85^\circ C$			± 5.5	
OUT Settling Time to 1% of Final Value		Gain = 20V/V, $V_{CC} = 12V$, $V_{RS+} = 12V$, $C_{LOAD} = 10pF$	$V_{SENSE} = 6.25mV$ to 100mV		20		μs
			$V_{SENSE} = 100mV$ to 6.25mV		20		
Capacitive-Load Stability		No sustained oscillations			1000		pF
OUT Output Resistance	R_{OUT}	$V_{SENSE} = 100mV$			1.5		Ω
Power-Supply Rejection	PSR	$V_{OUT} = 2V$, $V_{RS+} > 2V$		75	85		dB
Power-Up Time to 1% of Final Value		$V_{CC} = 12V$, $V_{RS+} = 12V$, $V_{SENSE} = 100mV$, $C_{LOAD} = 10pF$			0.5		ms
Saturation Recovery Time (Note 9)		$V_{CC} = 12V$, $V_{RS+} = 12V$, $C_{LOAD} = 10pF$			0.1		ms

Note 1: All devices are 100% production tested at $T_A = +25^\circ C$. All temperature limits are guaranteed by design.

Note 2: Guaranteed by PSR test.

Note 3: Guaranteed by OUT voltage error test.

Note 4: Output voltage is internally clamped not to exceed 12V.

Note 5: V_{OS} is extrapolated from the gain accuracy tests.

Note 6: Total OUT voltage error is the sum of gain and offset voltage errors.

Note 7: Measured at $I_{OUT} = -500\mu A$ ($R_{LOAD} = 4k\Omega$ for gain = 20V/V, $R_{LOAD} = 10k\Omega$ for gain = 50V/V, $R_{LOAD} = 20k\Omega$ for gain = 100V/V).

Note 8: 6.25mV = 1/16 of 100mV full-scale voltage (C/16).

Note 9: The device does not reverse phase when overdriven.

Typical Operating Characteristics

($V_{CC} = 12V$, $V_{RS+} = 12V$, $V_{SENSE} = 100mV$, $T_A = +25^{\circ}C$, unless otherwise noted.)

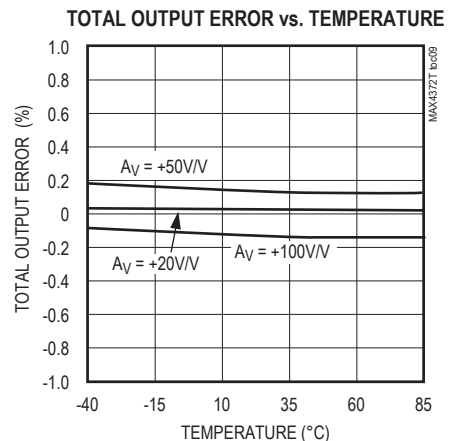
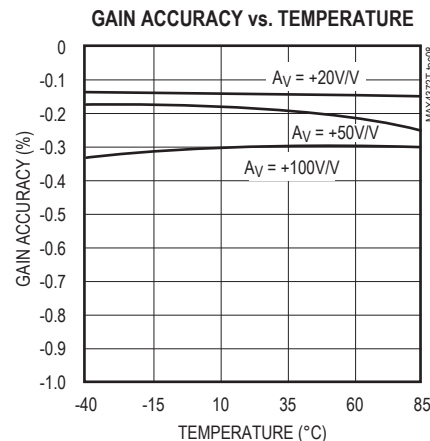
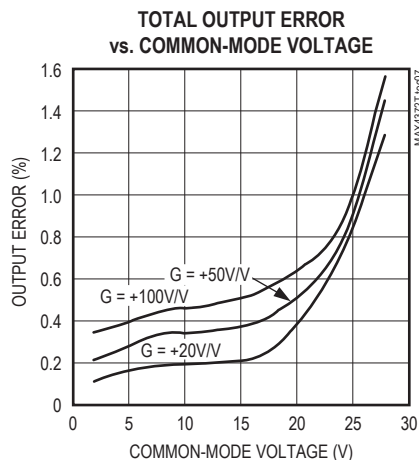
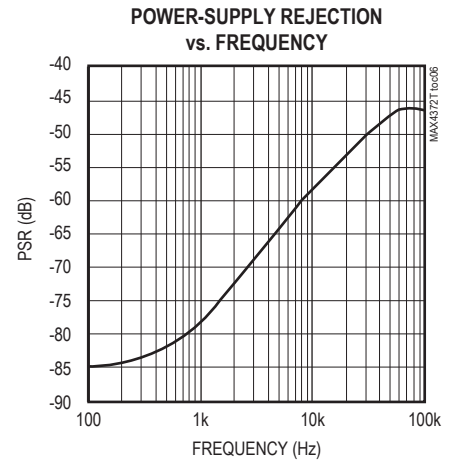
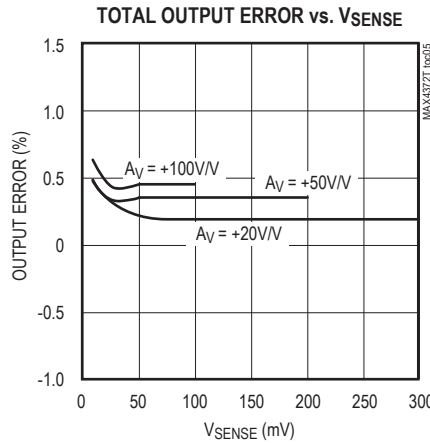
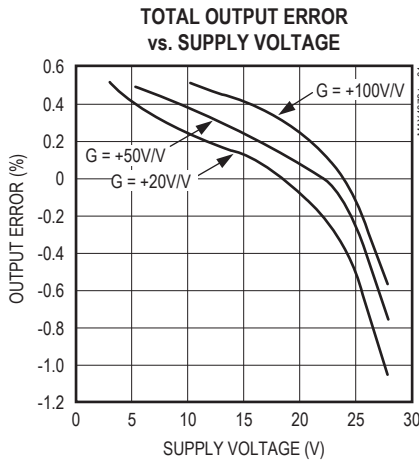
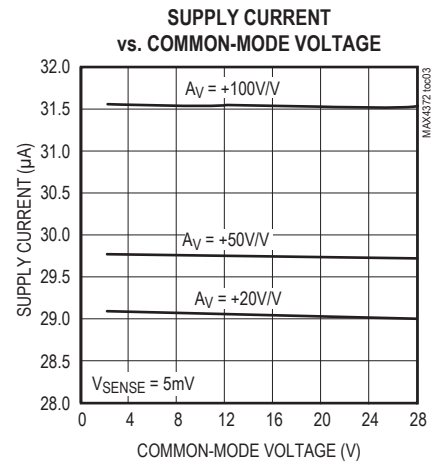
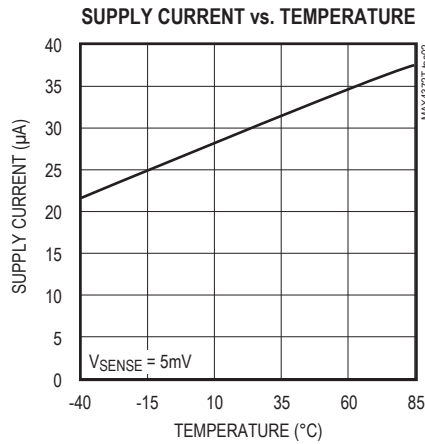
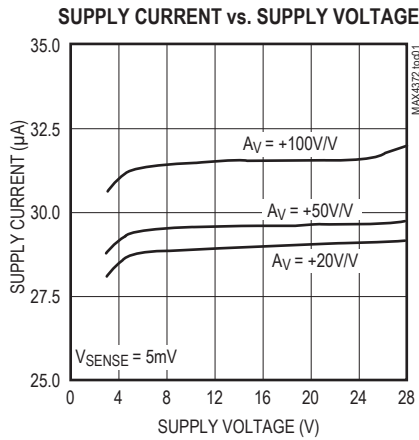

Typical Operating Characteristics (continued)

($V_{CC} = 12V$, $V_{RS+} = 12V$, $V_{SENSE} = 100mV$, $T_A = +25^{\circ}C$, unless otherwise noted.)

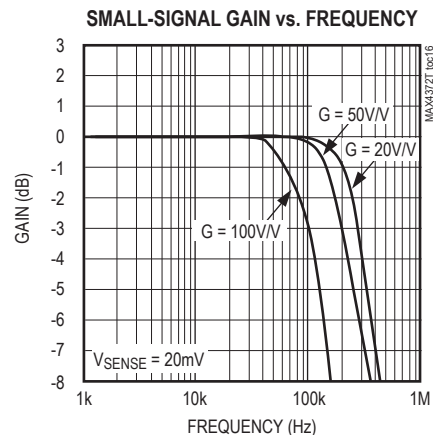
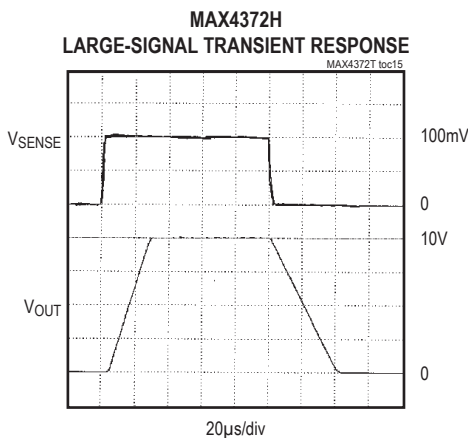
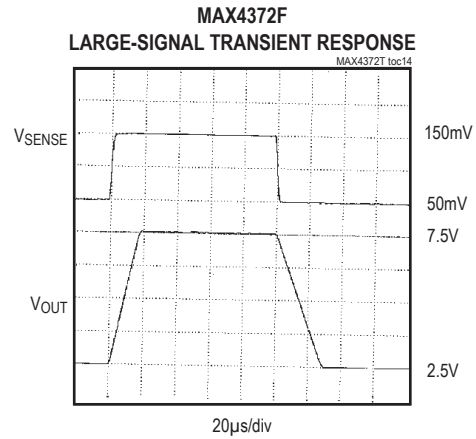
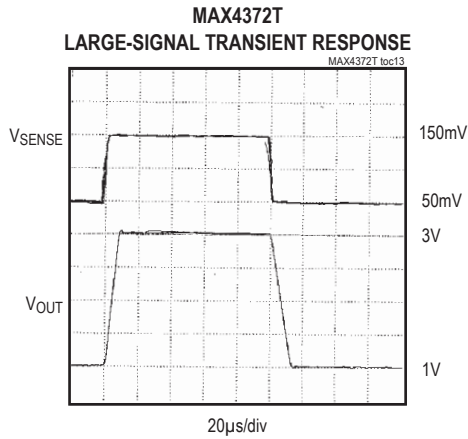
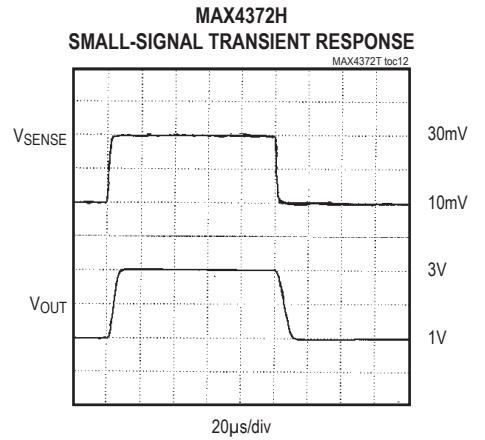
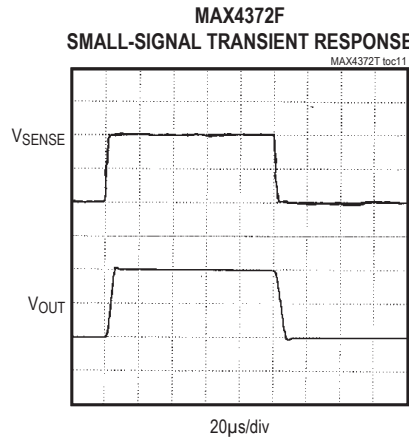
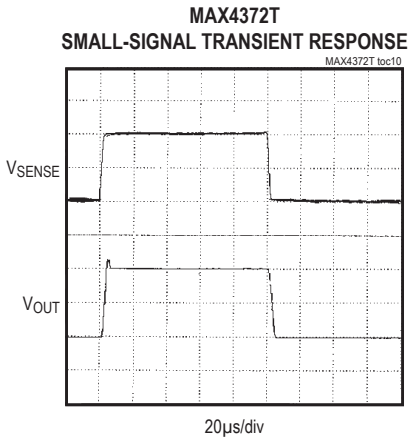

Table 1. Recommended Component Values

FULL-SCALE LOAD CURRENT, I_{LOAD} (A)	CURRENT-SENSE RESISTOR, R_{SENSE} (m Ω)	GAIN (V/V)	FULL-SCALE OUTPUT VOLTAGE (FULL-SCALE $V_{SENSE} = 100mV$), V_{OUT} (V)
0.1	1000	20	2.0
		50	5.0
		100	10.0
1	100	20	2.0
		50	5.0
		100	10.0
5	20	20	2.0
		50	5.0
		100	10.0
10	10	20	2.0
		50	5.0
		100	10.0

Using a PC Board Trace as R_{SENSE}

If the cost of R_{SENSE} is an issue and accuracy is not critical, use the alternative solution shown in Figure 2. This solution uses copper PC board traces to create a sense resistor. The resistivity of a 0.1in wide trace of 2oz copper is about 30m Ω /ft. The resistance temperature coefficient of copper is fairly high (approximately 0.4%/°C), so systems that experience a wide temperature variance must compensate for this effect. In addition, self-heating introduces a nonlinearity error. Do not exceed the maximum power dissipation of the copper trace.

For example, the MAX4372T (with a maximum load current of 10A and an R_{SENSE} of 5m Ω) creates a full-scale V_{SENSE} of 50mV that yields a maximum V_{OUT} of 1V. R_{SENSE} , in this case, requires about 2in of 0.1in wide copper trace.

UCSP Applications Information

For the latest application details on UCSP construction, dimensions, tape carrier information, printed circuit board techniques, bump-pad layout, and recommended reflow temperature profile, as well as the latest information on reliability testing results, go to the Maxim’s website at www.maxim-ic.com/ucsp to find the Application Note: UCSP—A Wafer-Level Chip-Scale Package.

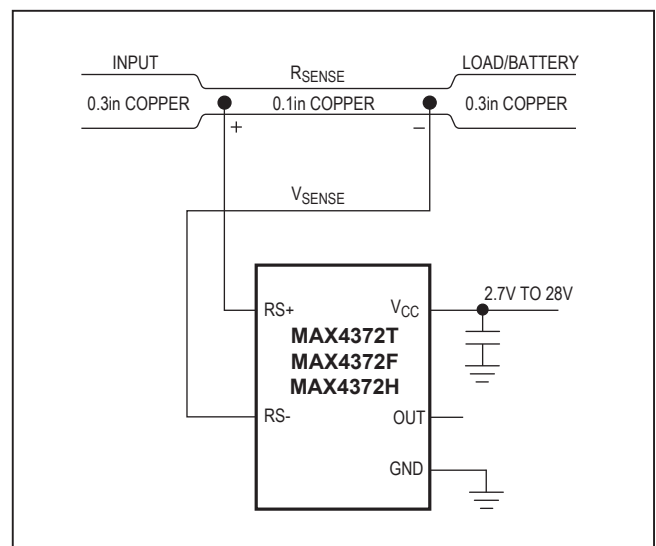

Figure 2. Connections Showing Use of PC Board

MAX4372T/F/H

Low-Cost, UCSP/SOT23, Micropower, High-Side Current-Sense Amplifier with Voltage Output

Ordering Information (continued)

PART	TEMP RANGE	PIN-PACKAGE	TOP MARK
MAX4372FEUK +T	-40°C to +85°C	5 SOT23	ADIV
MAX4372FESA+	-40°C to +85°C	8 SO	—
MAX4372FEBT+T	-40°C to +85°C	3 x 2 UCSP	ACX
MAX4372HEUK +T	-40°C to +85°C	5 SOT23	ADIW
MAX4372HESA+	-40°C to +85°C	8 SO	—
MAX4372HEBT+T	-40°C to +85°C	3 x 2 UCSP	ACZ

+Denotes lead(Pb)-free/RoHS-compliant package.
T = Tape and reel.

Pin Configurations (continued)

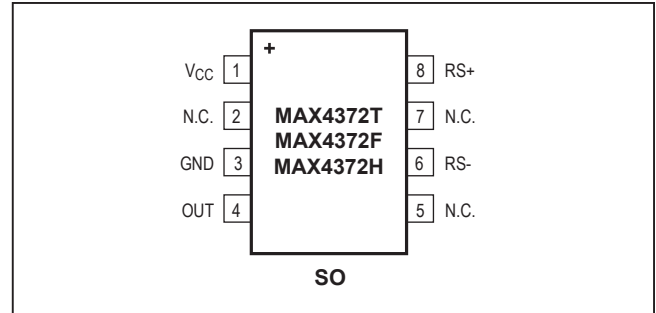

Chip Information

PROCESS: BICMOS

Package Information

For the latest package outline information and land patterns (footprints), go to www.maximintegrated.com/packages. Note that a "+", "#", or "-" in the package code indicates RoHS status only. Package drawings may show a different suffix character, but the drawing pertains to the package regardless of RoHS status.

PACKAGE TYPE	PACKAGE CODE	OUTLINE NO.	LAND PATTERN NO.
5 SOT23	U5+1	21-0057	90-0174
8 SO	S8+2	21-0041	90-0096
5 UCSP	B6+2	21-0097	—

TOP VIEW

COMMON DIMENSIONS	
A	0.62±0.05-0.08
A1	0.29±0.02
A2	0.33 REF.
b	∅0.35±0.03
D1	0.50 BASIC
E1	1.00 BASIC
e	0.50 BASIC
SD	0.25 BASIC
SE	0.00 BASIC

PKG. CODE	VARIABLE DIMENSIONS		DEPOPULATED SOLDER BALLS
	D	E	
B6-1	1.00±0.05	1.52±0.05	NONE
B6-2	1.00±0.05	1.52±0.05	B2
B6-3	1.05±0.05	1.57±0.05	NONE
B6-4	1.05±0.05	1.57±0.05	B2
B6-5	0.97±0.05	1.46±0.05	NONE
B6-6	1.16±0.05	1.57±0.05	NONE

NOTES:

- All dimensions in millimeters.
- Outer dimension (D & E) is defined by center lines between scribe lines.
- Marking shown is for package orientation reference only. Number of characters and lines vary per product.
- All dimensions are applicable to Leaded (-), PbFree (+), and MaxFilm parts/pkg codes.

BOTTOM VIEW

SIDE VIEW

—DRAWING NOT TO SCALE—

TITLE: PACKAGE OUTLINE, 6 BUMPS, 3X2 ARRAY, UCSP (B) PKG.		
APPROVAL	DOCUMENT CONTROL NO. 21-0097	REV. H 1/1

Note: MAX4372_EBT uses package code B6-2.

Package Information (continued)

For the latest package outline information and land patterns (footprints), go to www.maximintegrated.com/packages. Note that a "+", "#", or "-" in the package code indicates RoHS status only. Package drawings may show a different suffix character, but the drawing pertains to the package regardless of RoHS status.

TOP VIEW

SIDE VIEW

END VIEW

COMMON DIMENSIONS				
SYMBOL	INCHES		MM	
	MIN.	MAX.	MIN.	MAX.
A	.053	.069	1.35	1.75
A1	.004	.010	0.10	0.25
b	.014	.019	0.35	0.49
c	.007	.010	0.19	0.25
E	.150	.157	3.80	4.00
e	.050 BSC		1.27 BSC	
H	.228	.244	5.80	6.20
L	.016	.050	0.40	1.27
α	0°	8°	0°	8°

VARIATION A				
SYMBOL	INCHES		MM	
	MIN.	MAX.	MIN.	MAX.
D	.189	.197	4.80	5.00
N	8			
MS012	AA			
PKG. CODE	S8-2, S8-4, S8-5, S8-6F, S8-7F, S8-8F, S8-10F, S8-11F, S8-16F			

VARIATION B				
SYMBOL	INCHES		MM	
	MIN.	MAX.	MIN.	MAX.
D	.337	.344	8.55	8.75
N	14			
MS012	AB			
PKG. CODE	S14-1, S14-4, S14-5, S14-6; S14M-4, S14M-5, S14M-6, S14M-7			

VARIATION C				
SYMBOL	INCHES		MM	
	MIN.	MAX.	MIN.	MAX.
D	.386	.394	9.80	10.00
N	16			
MS012	AC			
PKG. CODE	S16-1, S16-3, S16-5, S16-6, S16-8, S16-7F, S16-9F, S16-10F; S16M-3, S16M-6			

NOTES:

- ALL DIMENSIONS ARE IN MILLIMETERS UNLESS OTHERWISE SPECIFIED.
- MATERIAL MUST COMPLY WITH BANNED AND RESTRICTED SUBSTANCES SPEC # 10-0131.
- DIMENSIONS D AND E DO NOT INCLUDE MOLD PROTRUSION. ALLOWABLE MOLD PROTRUSION IS 0.15 MM (.006") PER SIDE.
- LEADS TO BE COPLANAR WITHIN 0.10mm (.004").
- MEETS JEDEC MS012
- ALL DIMENSIONS APPLY TO BOTH LEADED (-) AND PbFREE (+) PKG. CODES.

-DRAWING NOT TO SCALE-

TITLE: PACKAGE OUTLINE, 8L, 14L, 16L SOIC .150 INCH		
APPROVAL	DOCUMENT CONTROL NO. 21-0041	REV. C 1/1

Package Information (continued)

For the latest package outline information and land patterns (footprints), go to www.maximintegrated.com/packages. Note that a "+", "#", or "-" in the package code indicates RoHS status only. Package drawings may show a different suffix character, but the drawing pertains to the package regardless of RoHS status.

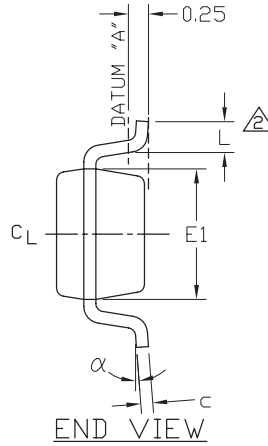
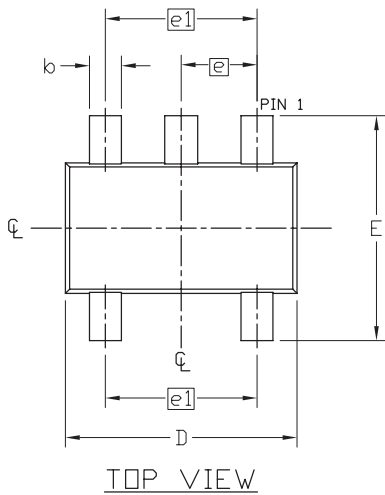

SYMBOL	MIN	NOM	MAX
A	0.90	1.25	1.45
A1	0.00	0.05	0.15
A2	0.90	1.10	1.30
b	0.35	0.40	0.50
c	0.08	0.15	0.20
D	2.80	2.90	3.00
E	2.60	2.80	3.00
E1	1.50	1.625	1.75
L	0.35	0.45	0.60
L1	0.60 REF		
e	0.95 BSC.		
e1	1.90 BSC.		
α	0°	2.5°	8°

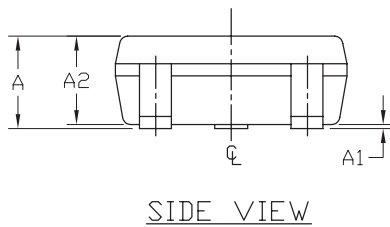

NOTES:

- ALL DIMENSIONS ARE IN MILLIMETERS UNLESS OTHERWISE SPECIFIED.
- FOOT LENGTH MEASURED AT INTERCEPT POINT BETWEEN DATUM A & LEAD SURFACE.
- PACKAGE OUTLINE EXCLUSIVE OF MOLD FLASH & METAL BURR. MOLD FLASH, PROTRUSION OR METAL BURR SHOULD NOT EXCEED 0.25 MM.
- MEETS JEDEC MO178, VARIATION AA.
- LEADS TO BE COPLANAR WITHIN 0.10 mm.
- SOLDER THICKNESS MEASURED AT FLAT SECTION OF LEAD BETWEEN 0.08mm AND 0.15mm FROM LEAD TIP.
- MATERIAL MUST COMPLY WITH BANNED AND RESTRICTED SUBSTANCES SPEC # 10-0131.
- ALL DIMENSIONS APPLY TO BOTH LEADED (-) AND LEAD FREE (+) PACKAGE CODES.
- PKG CODES: U5-1, U5-2

-DRAWING NOT TO SCALE-

TITLE: PACKAGE OUTLINE, 5L SOT23			
APPROVAL	DOCUMENT CONTROL NO. 21-0057	REV. G	1/1

Revision History

REVISION NUMBER	REVISION DATE	DESCRIPTION	PAGES CHANGED
4	7/09	Updated feature in accordance with actual performance of the product	1
5	5/11	Updated V_{RST} conditions to synchronize with tested material and added lead-free designation	1–3, 8

For pricing, delivery, and ordering information, please contact Maxim Direct at 1-888-629-4642, or visit Maxim Integrated's website at www.maximintegrated.com.

Maxim Integrated cannot assume responsibility for use of any circuitry other than circuitry entirely embodied in a Maxim Integrated product. No circuit patent licenses are implied. Maxim Integrated reserves the right to change the circuitry and specifications without notice at any time. The parametric values (min and max limits) shown in the Electrical Characteristics table are guaranteed. Other parametric values quoted in this data sheet are provided for guidance.